

# KRONOS

# KRONOS X

MUSIC WORKSTATION

## Parameter Guide

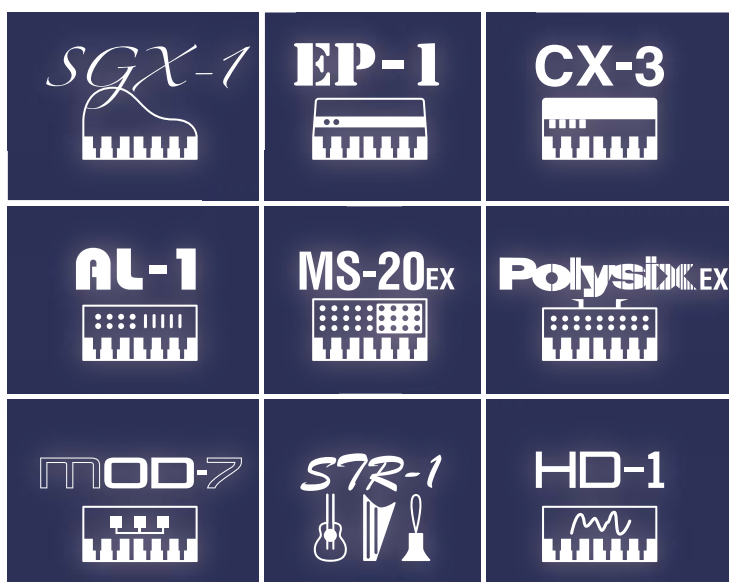

SONDIUS-XG

GENERAL  
MIDI

KARMA

KARMA® (Kay Algorithmic Realtime Music Architecture) and the KARMA Logo are registered trademarks representing patented technology licensed from Stephen Kay, Karma Lab LLC, [www.karma-lab.com](http://www.karma-lab.com).

Multi-Dimensional  
Synthesis

SST  
Smooth Sound  
Transitions

CMT

REMS

TouchView  
Graphical User Interface

# KORG



# Contents

---

<b>Program mode: HD-1</b> .....	<b>1</b>
<b>HD-1 Overview</b> .....	<b>1</b>
<b>Program P0: Play</b> .....	<b>2</b>
0-1: Main .....	2
0-2: Performance Meters .....	7
0-6: KARMA GE .....	9
0-7: Controller View/Effect .....	13
0-8: Audio Input/Sampling .....	14
0-9: Control Surface .....	21
<b>Program P1: Basic/Vector</b> .....	<b>36</b>
1-1: Program Basic .....	36
1-3: Drum Track .....	42
1-5: Vector Control .....	46
1-6: Vector Envelope .....	50
1-8: Set Up Controllers .....	53
1-9: Pads .....	54
<b>Program P2: OSC/Pitch</b> .....	<b>57</b>
2-1: OSC1 Basic .....	57
2-2: OSC1 Pitch .....	62
2-5: OSC2 Basic .....	65
2-6: OSC2 Pitch .....	65
2-9: Pitch EG .....	65
<b>Program P3: Filter</b> .....	<b>69</b>
3-1: Filter1 .....	69
3-2: Filter1 Modulation .....	72
3-3: Filter1 LFO Modulation .....	76
3-4: Filter1 EG .....	77
3-5: Filter2 .....	80
3-6: Filter2 Modulation .....	80
3-7: Filter2 LFO Modulation .....	80
3-8: Filter2 EG .....	81
<b>Program P4: Amp/EQ</b> .....	<b>82</b>
4-1: Amp1/Driver1 .....	82
4-2: Amp1 Modulation .....	84
4-3: Amp1 EG .....	87
4-5: Amp2/Driver2 .....	89
4-6: Amp2 Mod .....	90
4-7: Amp2 EG .....	90
4-9: EQ .....	90
<b>Program P5: LFO</b> .....	<b>92</b>
5-1: OSC1 LFO1 .....	92
5-2: OSC1 LFO2 .....	95
5-5: OSC2 LFO1 .....	95
5-6: OSC2 LFO2 .....	95
5-9: Common LFO .....	96
<b>Program P6: AMS Mixer/Common Key Track</b> ..	<b>98</b>
6-1: OSC 1 AMS Mixer .....	98
6-5: OSC 2 AMS Mix .....	104
6-9: Common Keyboard Track .....	105
<b>Program P7: KARMA</b> .....	<b>107</b>
7-1: GE Setup/Key Zones .....	107
7-2: MIDI Filter/CC Offset .....	110
7-3: Module Parameters-Control .....	112

7-4: Module Parameters-Trigger .....	117
7-5: GE Real-Time Parameters/Scenes .....	120
7-6: Perf Real-Time Parameters .....	123
7-7: Dynamic MIDI .....	128
7-8: Random Seeds .....	129
7-9: Name/Note Map .....	132
<b>Program P8: Insert Effect</b> .....	<b>134</b>
8-1: Routing .....	134
8-5: Insert FX .....	137
8-6: Track View .....	139
8-7: IFX 1-12 .....	140
8-9: Common FX LFO .....	141
<b>Program P9: Master/Total Effect</b> .....	<b>143</b>
9-1: Routing .....	143
9-2: MFX1 .....	145
9-3: MFX2 .....	146
9-4: TFX1 .....	146
9-5: TFX2 .....	146
<b>Program: Page Menu Commands</b> .....	<b>147</b>

---

<b>Program mode: EXi</b> .....	<b>165</b>
<b>EXi Program P0: Play</b> .....	<b>165</b>
0-1: Main .....	166
0-2: Performance Meters .....	167
0-6: KARMA GE .....	167
0-7: Controller View/Effects .....	167
0-8: Audio Input/Sampling .....	167
0-9: Control Surface .....	167
<b>EXi Program P4: Basic/Vector</b> .....	<b>169</b>
4-1: Program Basic .....	169
4-2: EXi Audio Input .....	174
4-3: Drum Track .....	175
4-5: Vector Control .....	175
4-6: Vector Envelope .....	175
4-8: Set Up Controllers .....	175
4-9: Pads .....	176
<b>EXi Program P5: Modulation</b> .....	<b>177</b>
5-1: Common Step Seq .....	177
5-2: Common LFO .....	180
5-3: Common Keyboard Track .....	180
<b>EXi Program: Page Menu Commands</b> .....	<b>181</b>

---

<b>EXi: AL-1 Analog Synthesizer</b> .....	<b>183</b>
<b>AL-1 Overview</b> .....	<b>183</b>
<b>EXi Program P0: Play</b> .....	<b>184</b>
0-1: Main .....	184
<b>Program P4: OSC Pitch</b> .....	<b>186</b>
4-1: OSC Basic .....	186
4-2: Sub/Noise/Ring Mod .....	189
4-3: Mixer .....	190
4-4: Pitch Common .....	192

4-5: Pitch EG/Mod . . . . .	194
<b>Program P5: Filter . . . . .</b>	<b>196</b>
5-1: Filter Basic . . . . .	196
5-2: Multi Filter . . . . .	199
5-3: Filter Modulation . . . . .	200
5-4: Filter LFO Mod . . . . .	203
<b>Program P6: Amp . . . . .</b>	<b>204</b>
6-1: Amp/Driver . . . . .	204
6-2: Amp Modulation . . . . .	206
6-3: Amp EG . . . . .	208
<b>Program P7: EG 1-4 . . . . .</b>	<b>211</b>
7-1: EG 1 (Filter) . . . . .	211
7-2: EG 2 (Pitch) . . . . .	214
7-3: EG 3 . . . . .	214
7-4: EG 4 . . . . .	214
<b>Program P8: Step Seq/LFO . . . . .</b>	<b>215</b>
8-1: Step Sequencer . . . . .	215
8-2: LFO 1 . . . . .	217
8-3: LFO 2 . . . . .	220
8-4: LFO 3 . . . . .	220
8-5: LFO 4 . . . . .	220
<b>Program P9: AMS Mixer . . . . .</b>	<b>221</b>
9-1: AMS Mixer . . . . .	221
<b>AL-1: Tone Adjust . . . . .</b>	<b>222</b>
<b>AL-1: Page Menu Commands . . . . .</b>	<b>224</b>

---

<b>EXi: CX-3 Tonewheel Organ . . . . .</b>	<b>225</b>
<b>CX-3 Overview . . . . .</b>	<b>225</b>
<b>EXi Program P0: Play . . . . .</b>	<b>226</b>
0-1: Main . . . . .	226
<b>Program P4: Basic . . . . .</b>	<b>228</b>
4-1: Basic . . . . .	228
4-2: Controllers . . . . .	229
<b>Program P5: Split &amp; Drawbars . . . . .</b>	<b>231</b>
5-1: Keyboard Split . . . . .	231
5-2: Drawbars . . . . .	232
5-3: EX Drawbars . . . . .	233
<b>Program P6: Percussion . . . . .</b>	<b>235</b>
6-1: Percussion . . . . .	235
6-2: EX Percussion . . . . .	237
<b>Program P7: Amp, V/C, Rotary Speaker . . . . .</b>	<b>238</b>
7-1: Amp & V/C . . . . .	238
7-2: Rotary Speaker . . . . .	240
<b>Program P9: AMS Mixer . . . . .</b>	<b>243</b>
9-1: AMS Mixer . . . . .	243

<b>CX-3: Tone Adjust . . . . .</b>	<b>244</b>
<b>Changes from the original CX-3 . . . . .</b>	<b>245</b>
<b>CX-3: Page Menu Commands . . . . .</b>	<b>246</b>

---

<b>EXi: STR-1 Plucked String . . . . .</b>	<b>247</b>
<b>STR-1 Overview . . . . .</b>	<b>247</b>
<b>EXi Program P0: Play . . . . .</b>	<b>249</b>
0-1: Main . . . . .	249
<b>Program P4: String . . . . .</b>	<b>251</b>
4-1: Pluck and Noise . . . . .	251
4-2: PCM Oscillator . . . . .	253
4-3: PCM Oscillator Pitch . . . . .	256
4-4: Excitation Mixer . . . . .	259
4-5: String Main . . . . .	261
4-6: Damping and Dispersion . . . . .	265
4-7: String Pitch . . . . .	267
4-8: Pickups and Feedback . . . . .	270
4-9: Mixer . . . . .	272
<b>Program P5: Filter . . . . .</b>	<b>274</b>
5-1: Filter Basic . . . . .	274
5-2: Multi Filter . . . . .	277
5-3: Filter Modulation . . . . .	279
5-4: Filter LFO Mod . . . . .	281
<b>Program P6: Amp . . . . .</b>	<b>283</b>
6-1: Amp . . . . .	283
6-2: Amp Modulation . . . . .	284
6-3: Amp EG . . . . .	286
<b>Program P7: EG 1-4 . . . . .</b>	<b>289</b>
7-1: EG 1 (Filter) . . . . .	289
7-2: EG 2 (Pitch) . . . . .	289
7-3: EG 3 . . . . .	289
7-4: EG 4 . . . . .	289
8-1: LFO 1 . . . . .	289
8-2: LFO 2 . . . . .	289
8-3: LFO 3 . . . . .	289
8-4: LFO 4 . . . . .	289
<b>Program P9: AMS Mixers and String Track . . . . .</b>	<b>290</b>
9-1: AMS Mixers 1-2 . . . . .	290
9-2: AMS Mixers 3-4 . . . . .	290
9-9: String Track . . . . .	290
<b>STR-1: Tone Adjust . . . . .</b>	<b>292</b>

---

<b>EXi: MS-20EX . . . . .</b>	<b>295</b>
<b>MS-20EX Overview . . . . .</b>	<b>295</b>
On-screen knobs and switches and the Parameter Details area . . . . .	296
<b>EXi Program P0: Play . . . . .</b>	<b>297</b>
0-1: Main . . . . .	297
<b>Program P4: Oscillators &amp; Filters . . . . .</b>	<b>299</b>
4-1: Oscillators & Filters . . . . .	299
<b>Program P5: MG, EG, &amp; Modulation . . . . .</b>	<b>303</b>
5-1: MG, EG, & Modulation . . . . .	303



<b>Program P6: Patch Panel</b> .....	<b>307</b>
6-1: Patch Panel .....	307
7-1: EG 3 .....	317
7-2: EG 4.....	317
7-3: EG 5 .....	317
7-4: EG 6 .....	317
8-1: LFO 1 .....	317
8-2: LFO 2 .....	317
8-3: LFO 3 .....	317
8-4: LFO 4 .....	317
9-1: AMS Mixers 1-2.....	318
9-2: AMS Mixers 3-4 .....	318

**MS-20EX: Tone Adjust** ..... **319**

---

**EXi: PolysixEX** ..... **323**

<b>PolysixEX Overview</b> .....	<b>323</b>
On-screen knobs and switches and the Parameter Details area .....	324

**EXi Program P0: Play** ..... **325**

0-1: Main .....	325
-----------------	-----

**Program P4: Main** ..... **327**

4-1: Main .....	327
-----------------	-----

**Program P5: Modulation & Arpeggiator** ..... **332**

5-1: Modulation & Arpeggiator .....	332
7-1: EG 2 .....	334
7-2: EG 3 .....	334
8-1: LFO 1 .....	334
8-2: LFO 2 .....	334
9-1: AMS Mixers 1-2 .....	334
9-2: AMS Mixers 3-4 .....	334

**PolysixEX: Tone Adjust** ..... **335**

---

**EXi: MOD-7 Waveshaping VPM  
Synthesizer** ..... **337**

<b>MOD-7 Overview</b> .....	<b>337</b>
Using the Parameter Details area .....	339
Loading DX sounds .....	339

**Synthesis with the MOD-7: a guided tour** .... **341**

Overview .....	341
Individual oscillators and subtractive synthesis	342
VPM (aka FM) .....	343
Filtered VPM .....	344
PCM as a VPM modulator .....	345
Waveshaping .....	346
Ring Modulation .....	348

**EXi Program P0: Play** ..... **350**

0-1: Main .....	350
-----------------	-----

**Program P4: Patch Panel**..... **352**

4-1: Patch Panel .....	352
------------------------	-----

**Program P5: Oscillators**..... **356**

5-1: Osc Main .....	356
5-2: PCM Osc .....	360
5-3: PCM Mod .....	362
5-4: VPM Osc1 .....	365
5-5: VPM Oscillator 2 .....	375

5-6: VPM Oscillator 3 .....	375
5-7: VPM Oscillator 4 .....	375
5-8: VPM Oscillator 5 .....	375
5-9: VPM Oscillator 6 .....	375

**Program P6: Filter** ..... **376**

6-1: Filter Basic.....	376
6-2: Multi Filter .....	376
6-3: Filter Modulation.....	376
6-4: Filter LFO Mod.....	376

**Program P7: Amp** ..... **377**

7-1: Mixers 1-3 .....	377
7-2: Main Mixer .....	378
7-3: Amp .....	379
7-4: Amp Modulation.....	379
7-5: Amp EG .....	379

**Program P8: EG 1-9** ..... **380**

8-1: EG 1 .....	380
8-2: EG 2 .....	383
8-3: EG 3 .....	383
8-4: EG 4 .....	383
8-5: EG 5 .....	383
8-6: EG 6 .....	383
8-7: EG 7 .....	383
8-8: EG 8 .....	383
8-9: EG 9 .....	383

**Program P9: Step Sequencer, LFO 1-4,  
and AMS Mixers** ..... **384**

9-1: Step Sequencer .....	384
9-2: LFO 1 .....	384
9-3: LFO 2 .....	384
9-4: LFO 3 .....	384
9-5: LFO 4 .....	384
9-6: AMS Mixers 1-2 .....	384
9-7: AMS Mixers 3-4 .....	384
9-8: AMS Mixers 5-6 .....	384
9-9: AMS Mixers 7-8 .....	384

**MOD-7: Tone Adjust** ..... **385**

---

**EXi: SGX-1 Premium Piano**..... **387**

**SGX-1 Overview**..... **387**

**EXi Program P0: Play** ..... **388**

0-1: Main .....	388
-----------------	-----

**Program P4: Main** ..... **390**

4-1: Main .....	390
-----------------	-----

**SGX-1: Tone adjust** ..... **393**

---

**EXi: EP-1 MDS Electric Piano** ..... **395**

**EP-1 Overview** ..... **395**

On-screen knobs, sliders & switches and the Parameter Details area .....	396
---	-----

**EXi Program P0: Play** ..... **397**

0-1: Main .....	397
-----------------	-----

**Program P4: Basic/Oscillator** ..... **399**

P4-1 Basic .....	399
------------------	-----

P4-2 Oscillator .....	401
<b>Program P5: Panel/IFX/Amp &amp; Cabinet .....</b>	<b>403</b>
P5-1 Common .....	403
Tine EP .....	405
Reed EP .....	407
Insert Effects .....	408
<b>Program P9: AMS Mixers .....</b>	<b>412</b>
P9 AMS Mixers .....	412
<b>EP-1: Tone Adjust .....</b>	<b>413</b>
<hr/>	
<b>Combination mode .....</b>	<b>415</b>
<b>Combination P0: Play .....</b>	<b>415</b>
0-1: Program Select/Mixer .....	415
0-2: Performance Meters .....	421
0-6: KARMA GE .....	422
0-7: Controller View/Effect .....	425
0-8: Audio Input/Sampling .....	426
0-9: Control Surface .....	428
<b>Combination P1: EQ/Vector/Controller .....</b>	<b>440</b>
1-1: Timbre EQ .....	440
1-3: Drum Track .....	441
1-5: Vector Volume Control .....	442
1-6: Vector CC Control .....	446
1-7: Vector Envelope .....	448
1-8: Set Up Controllers .....	451
1-9: Pads .....	452
<b>Combination P2: Timbre Parameters .....</b>	<b>454</b>
2-1: MIDI .....	454
2-2: OSC .....	455
2-3: Pitch .....	457
2-4: Delay .....	458
2-5: Wave Sequence/KARMA .....	459
2-6: EXi Audio Input .....	461
<b>Combination P3: MIDI Filter/Zones .....</b>	<b>462</b>
3-1: MIDI Filter1 .....	462
3-2: MIDI Filter2 .....	464
3-3: MIDI Filter3 .....	465
3-5: Keyboard Zones .....	466
3-6: Velocity Zones .....	468
<b>Combination P7: KARMA .....</b>	<b>470</b>
7-1: GE Setup/Key Zones .....	470
7-2: MIDI Filter/CC Offset .....	474
7-3: Module Parameters-Control .....	475
7-4: Module Parameters-Trigger .....	476
7-5: GE Real-Time Parameters/Scenes .....	478
7-6: Perf Real-Time Parameters .....	481
7-7: Dynamic MIDI .....	482
7-8: Random Seeds .....	484
7-9: Name/Note Map .....	486
<b>Combination P8: Insert Effect .....</b>	<b>488</b>
8-1: Routing1 .....	488
8-2: Routing2 .....	491
8-5: Insert FX .....	492
8-6: Track View .....	494
8-7: IFX 1-12 .....	495
8-9: Common FX LFO .....	497

<b>Combination P9: Master/Total Effect .....</b>	<b>498</b>
9-1: Routing .....	498
9-2: MFX1 .....	499
9-3: MFX2 .....	500
9-4: TFX1 .....	500
9-5: TFX2 .....	500
<b>Combination: Page Menu Commands .....</b>	<b>501</b>
<hr/>	
<b>Sequencer mode .....</b>	<b>509</b>
<b>Sequencer Overview .....</b>	<b>509</b>
MIDI sequencer .....	509
Setup parameters & Musical data .....	511
Tip: .....	512
<b>Sequencer P0: Play/REC .....</b>	<b>513</b>
0-1: MIDI Track Prog Select/Mixer .....	513
0-2: Audio Track Mixer .....	519
0-3: MIDI Track Loop .....	524
0-4: Performance Meters .....	525
0-5: Preferences .....	525
0-6: KARMA GE .....	529
0-7: Controller View/Effect .....	531
0-8: Audio In/Sampling .....	532
0-9: Control Surface .....	534
<b>Sequencer P1: EQ/Vector/Controller .....</b>	<b>546</b>
1-1: MIDI Track EQ .....	546
1-2: Audio Track EQ .....	548
1-3: Drum Track .....	549
1-5: Vector Volume Control .....	551
1-6: Vector CC Control .....	554
1-7: Vector Envelope .....	557
1-8: Set Up Controllers .....	560
1-9: Pads .....	562
<b>Sequencer P2: Track Parameters .....</b>	<b>564</b>
2-1: MIDI .....	564
2-2: OSC .....	566
2-3: Pitch .....	568
2-4: Delay .....	570
2-5: Wave Sequence/KARMA .....	571
2-6: EXi Audio Input .....	573
2-7: Audio Track Delay .....	574
<b>Sequencer P3: MIDI Filter/Zones .....</b>	<b>576</b>
3-1: MIDI Filter1 .....	576
3-2: MIDI Filter2 .....	578
3-3: MIDI Filter3 .....	579
3-5: Keyboard Zones .....	580
3-6: Velocity Zones .....	582
<b>Sequencer P4: Track Edit .....</b>	<b>584</b>
4-1: Track Edit .....	584
4-2: MIDI Track Name .....	586
4-3: AUDIO Track Name .....	587
<b>Sequencer P5: Pattern/RPPR .....</b>	<b>588</b>
5-1: Pattern Edit .....	588
5-2: Pattern Name .....	590
5-3: RPPR Setup .....	591
<b>Sequencer P7: KARMA .....</b>	<b>594</b>
7-1: GE Setup/Key Zones .....	595

7-2: MIDI Filter/CC Offset	599
7-3: Module Parameters-Control	600
7-4: Module Parameters-Trigger	601
7-5: GE Real-Time Parameters/Scenes	602
7-6: Perf Real-Time Parameters	604
7-7: Dynamic MIDI	605
7-8: Random Seeds	606
7-9: Name/Note Map	607
<b>Sequencer P8: Insert Effect</b>	<b>609</b>
8-1: MIDI Routing1	609
8-2: MIDI Routing2	611
8-3: Audio Routing1	612
8-4: Audio Routing2	614
8-5: Insert FX	615
8-6: Track View	616
8-7: IFX 1-12	618
8-9: Common FX LFO	620
<b>Sequencer P9: Master/Total Effect</b>	<b>621</b>
9-1: Routing	621
9-2: MFX1	622
9-3: MFX2	623
9-4: TFX1	623
9-5: TFX2	623
<b>Sequencer: Page Menu Commands</b>	<b>624</b>
<b>System Exclusive events supported in Sequencer mode</b>	<b>661</b>
<hr/>	
<b>Set List mode</b>	<b>663</b>
Overview	663
<b>Set List P0: Play</b>	<b>664</b>
0-1: Play	664
<b>Set List P1: Edit</b>	<b>667</b>
1-1: Edit	667
<b>Set List P9: Control Surface</b>	<b>670</b>
9-1: Control Surface	670
<b>Set List: Page Menu Commands</b>	<b>673</b>
<hr/>	
<b>Sampling mode</b>	<b>675</b>
<b>Sampling Overview</b>	<b>675</b>
Sampling to RAM, or direct to disk	675
Sampling features	676
<b>Sampling P0: Recording</b>	<b>679</b>
0-1: Recording	679
0-8: Audio Input	685
0-9: Control Surface	690
<b>Sampling P1: Sample Edit</b>	<b>697</b>
1-1: Sample Edit	697
<b>Sampling P2: Loop Edit</b>	<b>700</b>
2-1: Loop Edit	700
<b>Sampling P3: Multisample Edit</b>	<b>703</b>
3-1: Multisample Edit	703
<b>Sampling P4: EQ/Controller</b>	<b>706</b>
4-1: EQ	706
4-8: Set Up Controllers	707

4-9: Pads	709
<b>Sampling P5: Audio CD</b>	<b>711</b>
5-1: Ripping	711
<b>Sampling P8: Insert Effect</b>	<b>714</b>
8-1: Routing	714
8-5: Insert FX	716
8-6: Track View	718
8-7: IFX 1-12	719
8-9: Common FX LFO	720
<b>Sampling P9: Master/Total Effect</b>	<b>722</b>
9-1: Routing	722
9-2: MFX1	724
9-3: MFX2	725
9-4: TFX1	725
9-5: TFX2	725
<b>Sampling: Page Menu Commands</b>	<b>726</b>
<hr/>	
<b>Global mode</b>	<b>753</b>
<b>Global P0: Basic Setup</b>	<b>753</b>
0-1: Basic Setup	753
0-2: Audio Input	759
0-3: KSC Auto-Load	762
0-4: Sample Management	765
0-5: Network	767
<b>Global P1: MIDI</b>	<b>770</b>
1-1: MIDI	770
1-2: External 1	777
1-3: External 2	779
<b>Global P2: Controllers/Scales</b>	<b>781</b>
2-1: Controllers	781
2-2: User Scale	783
<b>Global P3: Category Name</b>	<b>785</b>
3-1: Program Category	785
3-2: Combi Category	786
3-3: KARMA Category	786
<b>Global P4: Wave Sequence</b>	<b>787</b>
4-1: Sequence Parameters	787
4-2: Per-Step Parameters	792
<b>Global P5: Drum Kit</b>	<b>796</b>
5-1: Sample Setup	797
5-2: Sample Parameters	800
5-3: Voice Assign/Mixer	801
<b>Global P6: Options Info</b>	<b>803</b>
<b>Global: Page Menu Commands</b>	<b>806</b>
<hr/>	
<b>Disk mode</b>	<b>815</b>
<b>Disk P0: File</b>	<b>817</b>
0-1: Load	817
0-2: Save	819
0-3: Utility	821
0-9: Media Information	822
<b>Disk P1: Audio CD</b>	<b>823</b>
1-1: Make Audio CD	823
1-2: Play Audio CD	825

1–9: Media Information.....	827	025: Piano Body/Damper .....	916
<b>Disk: Page Menu Commands.....</b>	<b>828</b>	026: Vocoder.....	916
<hr/>			
<b>Effect Guide .....</b>	<b>857</b>	<b>Overdrive, Amp models, and Mic models ....</b>	<b>918</b>
<b>Overview.....</b>	<b>857</b>	027: OD/Hi-Gain Wah.....	918
Effects in each mode .....	857	028: OD/HyperGain Wah.....	919
Dynamic modulation (Dmod) and Tempo		029: Stereo Guitar Cabinet .....	920
Synchronization.....	859	030: Guitar Amp Model +P4EQ.....	920
Common FX LFOs .....	860	031: Guitar Amp Model +Cabinet.....	921
FX Control Buses .....	860	032: Stereo Bass Cabinet.....	922
Effect I/O .....	862	033: Bass Amp Model .....	922
<b>Insert Effects (IFX1...IFX12).....</b>	<b>864</b>	034: Bass Amp Model +Cabinet.....	923
In/Out.....	864	035: Bass Amp TubeDrive +Cab .....	924
Routing .....	865	036: Tube PreAmp Modeling.....	925
Mixer .....	874	037: St. Tube PreAmp Modeling.....	925
Controlling the Insert Effects via MIDI .....	876	038: Mic Modeling +PreAmp.....	926
<b>Master Effects (MFX1, 2).....</b>	<b>877</b>	039: St. Mic Modeling +PreAmp .....	926
In/Out.....	877	<b>Chorus, Flanger, and Phaser .....</b>	<b>927</b>
Routing .....	878	040: Stereo Chorus.....	927
Mixer .....	881	041: Stereo Harmonic Chorus .....	928
Controlling the Master Effects via MIDI .....	882	042: St. Bi-phase Modulation.....	929
<b>Total Effects (TFX1, 2).....</b>	<b>883</b>	043: Multitap Cho/Delay 4Taps.....	930
In/Out.....	883	044: Multitap Cho/Delay 6Taps.....	930
Routing .....	883	045: Bi Chorus .....	931
Mixer .....	884	046: Ensemble.....	933
Using MIDI to control the Total Effects .....	884	047: Polysix Ensemble.....	933
<b>Outputs.....</b>	<b>885</b>	048: Stereo Flanger.....	934
Main Outputs .....	885	049: Stereo Random Flanger .....	935
Individual Outputs .....	885	050: Stereo Envelope Flanger.....	935
<b>Effect/Mixer Block Diagrams.....</b>	<b>886</b>	051: Stereo Phaser .....	936
<b>Dynamics.....</b>	<b>889</b>	052: Stereo Random Phaser .....	937
000: No Effect .....	889	053: Stereo Envelope Phaser .....	938
001: Stereo Dyna Compressor .....	889	054: Bi Phaser .....	939
002: Stereo Compressor.....	890	<b>Modulation and Pitch Shift .....</b>	<b>940</b>
003: Stereo Expander.....	893	055: Stereo Vibrato.....	940
004: St.Multiband Compressor.....	894	056: Stereo Auto Fade Mod.....	941
005: Stereo Limiter .....	896	057: 2-Voice Resonator .....	942
006: Multiband Limiter .....	897	058: Doppler.....	943
007: Stereo Multiband Limiter .....	898	059: Scratch .....	944
008: Stereo Mastering Limiter .....	899	060: Grain Shifter.....	944
009: Stereo Gate .....	900	061: Stereo Tremolo.....	945
010: Stereo Noise Reduction.....	901	062: Stereo Envelope Tremolo .....	946
<b>EQ and Filters.....</b>	<b>902</b>	063: Stereo Auto Pan .....	947
011: Stereo Parametric 4EQ .....	902	064: Stereo Phaser+Tremolo.....	948
012: Stereo Graphic 7EQ .....	903	065: Stereo Ring Modulator .....	949
013: Stereo Master 3EQ .....	904	066: Stereo Frequency Shifter.....	950
014: Stereo Exciter/Enhncr .....	905	067: Detune .....	951
015: Stereo Isolator.....	906	068: Pitch Shifter .....	951
016: Stereo Wah/Auto Wah .....	906	069: Stereo Pitch Shifter .....	952
017: St. Vintage/Custom Wah.....	908	070: Pitch Shifter BPM.....	953
018: Stereo Random Filter.....	909	071: Stereo Pitch Shifter BPM.....	954
019: Multi Mode Filter .....	910	072: Pitch Shift Mod.....	955
020: Stereo Sub Oscillator .....	911	073: Organ Vibrato/Chorus .....	956
021: Talking Modulator.....	912	074: Rotary Speaker.....	957
022: Stereo Decimator .....	913	075: Rotary Speaker Pro OD .....	958
023: Stereo Analog Record .....	914	076: Rotary Speaker Pro CX.....	959
024: Stereo Wave Shaper.....	914	<b>Delay.....</b>	<b>961</b>
		077: L/C/R Delay .....	961
		078: L/C/R Long Delay .....	961
		079: Stereo/Cross Delay .....	962

080: Stereo/Cross Long Delay	963
081: Stereo Multitap Delay	963
082: Stereo Modulation Delay	964
083: Stereo Dynamic Delay	965
084: Stereo Auto Panning Delay	966
085: Tape Echo	967
086: Multiband Mod. Delay	968
087: Reverse Delay	969
088: Hold Delay	970
089: Auto Reverse	971
090: Sequence BPM Delay	972
091: L/C/R BPM Delay	973
092: L/C/R BPM Long Delay	974
093: Stereo BPM Delay	975
094: Stereo BPM Long Delay	976
095: Stereo BPM Multitap Delay	977
096: Stereo BPM Mod. Delay	978
097: St. BPM Auto Panning Dly	979
098: Tape BPM Echo	980
099: Reverse BPM Delay	981
<b>Reverb and Early Reflections</b>	<b>983</b>
100: Overb	983
101: Reverb Hall	984
102: Reverb Smooth Hall	984
103: Reverb Wet Plate	984
104: Reverb Dry Plate	984
105: Reverb Room	985
106: Reverb Bright Room	985
107: Early Reflections	986
108: Early Reflections Hi Dens	986
<b>Mono-Mono Serial</b>	<b>988</b>
109: P4EQ - Exciter	991
110: P4EQ - Wah	991
111: P4EQ - Chorus/Flanger	991
112: P4EQ - Phaser	992
113: P4EQ - Multitap Delay	992
114: Comp - Wah	992
115: Comp - Amp Sim	993
116: Comp - OD/HiGain	993
117: Comp - P4EQ	993
118: Comp - Chorus/Flanger	994
119: Comp - Phaser	994
120: Comp - Multitap Delay	995
121: Limiter - P4EQ	995
122: Limiter - Chorus/Flanger	995
123: Limiter - Phaser	996
124: Limiter - Multitap Delay	996
125: Exciter - Comp	997
126: Exciter - Limiter	997
127: Exciter - Chorus/Flanger	997
128: Exciter - Phaser	998
129: Exciter - Multitap Delay	998
130: OD/Hi Gain - Amp Sim	998
131: OD/Hi Gain - Cho/Flanger	999
132: OD/Hi Gain - Phaser	999
133: OD/Hi Gain - Multitap Dly	999
134: Wah - Amp Sim	1000
135: Decimator - Amp Sim	1000
136: Decimator - Comp	1000
137: Amp Sim - Tremolo	1001

138: Cho/Flanger - Multitap Dly	1002
139: Phaser - Chorus/Flanger	1002
140: Reverb - Gate	1002

**Mono/Mono Parallel**.....**1004**

141: P4EQ // P4EQ	1007
142: P4EQ // Comp	1007
143: P4EQ // Limiter	1008
144: P4EQ // Exciter	1008
145: P4EQ // OD/Hi Gain	1008
146: P4EQ // Wah	1008
147: P4EQ // Chorus/Flanger	1009
148: P4EQ // Phaser	1009
149: P4EQ // Multitap BPM Dly	1009
150: Comp // Comp	1009
151: Comp // Limiter	1010
152: Comp // Exciter	1010
153: Comp // OD/Hi Gain	1010
154: Comp // Wah	1010
155: Comp // Chorus/Flanger	1011
156: Comp // Phaser	1011
157: Comp // Multitap BPM Dly	1011
158: Limiter // Limiter	1011
159: Limiter // Exciter	1012
160: Limiter // OD/Hi Gain	1012
161: Limiter // Wah	1012
162: Limiter // Chorus/Flanger	1012
163: Limiter // Phaser	1013
164: Limiter // Mtap BPM Dly	1013
165: Exciter // Exciter	1013
166: Exciter // OD/Hi Gain	1013
167: Exciter // Wah	1014
168: Exciter // Chorus/Flanger	1014
169: Exciter // Phaser	1014
170: Exciter // Mtap BPM Dly	1014
171: OD/Hi Gain // OD/Hi Gain	1015
172: OD/Hi Gain // Wah	1015
173: OD/Hi Gain // Cho/Flanger	1015
174: OD/Hi Gain // Phaser	1015
175: OD/Hi Gain // Mt BPM Dly	1016
176: Wah // Wah	1016
177: Wah // Chorus/Flanger	1016
178: Wah // Phaser	1016
179: Wah // Multitap BPM Dly	1017
180: Cho/Flange // Cho/Flanger	1017
181: Cho/Flange // Phaser	1017
182: Cho/Flange // Mt BPM Dly	1017
183: Phaser // Phaser	1018
184: Phaser // Mtap BPM Dly	1018
185: Mt.BPM Dly // Mt.BPM Dly	1018

**KARMA GE guide** ..... **1019**

**About the KARMA GE guide**.....**1019**

How to read the "GE Guide"	1019
How GE parameter names are displayed	1019

**About KARMA**.....**1021**

Overview	1021
Theory Of Operation	1021
KARMA Architecture (Diagram)	1022

<b>GE (Generated Effect) Group</b> .....	<b>1023</b>	About WaveSeq Patterns .....	1056
Overview .....	1023	Global Parameters .....	1056
GE Global Parameters .....	1023	Pattern Grid & Associated Parameters .....	1057
<b>Note Series Group</b> .....	<b>1026</b>	Random Weighting Parameters .....	1058
Overview .....	1026	Associated Parameters .....	1058
Parameters .....	1026	<b>Envelope Group</b> .....	<b>1059</b>
<b>Phase Group</b> .....	<b>1030</b>	Overview .....	1059
Overview .....	1030	About Envelopes .....	1059
About Phase Patterns .....	1030	Parameters .....	1059
General Parameters .....	1030	Level Combinations .....	1062
Phase Specific Parameters .....	1032	Time Combinations .....	1062
End Loop Parameters .....	1033	<b>Repeat (Melodic Repeat) Group</b> .....	<b>1063</b>
Pattern Parameters .....	1033	Overview .....	1063
<b>Rhythm Group</b> .....	<b>1035</b>	General Parameters .....	1063
Overview .....	1035	Range Parameters .....	1066
About Rhythm Patterns .....	1035	GE Mode = Real-Time Parameters .....	1067
Global Parameters .....	1035	<b>Bend Group</b> .....	<b>1069</b>
Pattern Grid & Associated Parameters .....	1036	Overview .....	1069
Random Weighting Parameters - Pools .....	1037	General Parameters .....	1069
Random Weighting Parameters - Ties .....	1038	GE Mode = Real-Time Parameters .....	1071
Associated Parameters .....	1038	<b>Drum Group</b> .....	<b>1073</b>
<b>Duration Group</b> .....	<b>1040</b>	Overview .....	1073
Overview .....	1040	About Drum Patterns .....	1073
About Duration Patterns .....	1040	Pattern Editing Grid & Associated Parameters .....	1073
Pattern Grid & Associated Parameters .....	1040	Associated Parameters .....	1074
Associated Parameters .....	1040	Random Weighting Parameters- Pools .....	1075
Random Weighting Parameters - Pools .....	1042	Random Weighting Parameters- Rests .....	1076
Random Weighting Parameters - Ties .....	1042	Associated Parameters .....	1076
Associated Parameters .....	1042	<b>Direct Index Group</b> .....	<b>1080</b>
<b>Index Group</b> .....	<b>1043</b>	Overview .....	1080
Overview .....	1043	General Parameters .....	1080
About Index Patterns .....	1043	Duration Parameters .....	1081
Pattern Grid & Associated Parameters .....	1043	Repeat Parameters .....	1082
Associated Parameters .....	1043	Bend Parameters .....	1082
Random Weighting Parameters .....	1044	<b>Appendices</b> .....	<b>1084</b>
Associated Parameters .....	1044	Using Auto-Bend .....	1084
<b>Cluster Group</b> .....	<b>1047</b>	Random Weighting Curves .....	1086
Overview .....	1047		
About Cluster Patterns .....	1047	<b>Appendices</b> .....	<b>1089</b>
Pattern Grid & Associated Parameters .....	1047	<b>Alternate Modulation Sources (AMS)</b> .....	<b>1089</b>
Random Weighting Parameters .....	1048	Alternate Modulation Overview .....	1089
Associated Parameters .....	1048	Alternate Modulation Source (AMS) List .....	1091
<b>Velocity Group</b> .....	<b>1049</b>	Alternate Modulation settings .....	1095
Overview .....	1049	<b>Dynamic Modulation Sources (Dmod)</b> .....	<b>1101</b>
About Velocity Patterns .....	1049	Overview .....	1101
Global Parameters .....	1049	Dynamic Modulation Source List .....	1101
Pattern Grid & Associated Parameters .....	1050	<b>Controller Assignments</b> .....	<b>1104</b>
Random Weighting Parameters .....	1050	SW1/2 Assignments .....	1104
Associated Parameters .....	1050	Realtime Knobs 5-8 Assignments .....	1105
<b>CCs/Pitch Group</b> .....	<b>1052</b>	Foot Switch Assignments .....	1106
Overview .....	1052	Foot Pedal Assignments .....	1108
About CC/Bend/Pitch Patterns .....	1052	<b>Dynamic MIDI Sources &amp; Destinations</b> .....	<b>1109</b>
Pattern Grid & Associated Parameters .....	1052	Dynamic MIDI Sources .....	1109
Random Weighting Parameters .....	1053	Dynamic MIDI Destinations .....	1111
Global Parameters .....	1054		
Associated Parameters .....	1054		
<b>WaveSeq Group</b> .....	<b>1056</b>		
Overview .....	1056		

---

<b>MIDI transmission from KRONOS controllers</b>	<b>1116</b>
<b>KRONOS and MIDI CCs</b>	<b>1120</b>
Responses to standard MIDI controllers	1120
Parameters controlled by MIDI CCs #70-79	1123
<b>MIDI applications</b>	<b>1127</b>
About MIDI	1127
Connecting MIDI devices & computers	1127
USB MIDI controllers	1128
Messages transmitted and received by the KRONOS	1129
<b>MIDI Implementation</b>	<b>1142</b>
<b>Disk mode and file format information</b>	<b>1146</b>
AIFF and WAVE format details: importing	1146
AIFF and WAVE format details: exporting	1146
Korg format sample files	1147
OASYS .SNG file compatibility	1152
CD-R/RW disks on the KRONOS: UDF and packet-writing	1153
Notice: Use of GPL and LGPL software	1154
<b>Updating the system</b>	<b>1155</b>
<b>Restoring the system and factory sounds</b>	<b>1156</b>





# Program mode: HD-1

## HD-1 Overview

### Flagship sampling & Wave Sequencing synth

We named the HD-1 “High Definition” because of its superior sound, starting with Korg’s proprietary low-aliasing sample playback oscillators, full-bandwidth multimode resonant filters, and extraordinarily fast & smooth envelopes and LFOs.

Virtual Memory Technology (VMT) gives the HD-1 access to gigabytes of onboard samples covering every “meat and potatoes” sound in exquisite detail, from orchestral to classic rock to hip-hop, all instantly available.

### Wave Sequencing

Wave Sequences play a series of samples over time, creating distinctive rhythmic timbres or smooth, complex evolving sounds. Additionally, step-sequencer modulation outputs allow Wave Sequences to control any modulatable Program parameter.

In the HD-1, Wave Sequences can be used interchangeably with standard Multisamples. Wave Sequences are edited in Global mode; for more information, see “Global P4: Wave Sequence” on page 787.

### Main Features

- Korg’s proprietary ultra-high-quality sample interpolation provides minimal aliasing, crystal-clear high frequencies, and sound that is smooth, rich, and detailed across the entire audio spectrum.
- Gigabytes of ROM and EXs sample libraries
- User Sample Banks allow multiple gigabyte-sized custom libraries
- Dual-oscillator structure, providing two complete voice chains for layers and splits
- Within each oscillator, up to eight-way velocity splits and crossfades (including two-way layers)
- Wave Sequencing, for creating rhythmic patterns or complex, evolving timbres
- Vector Synthesis
- Dual multi-mode resonant filters
- Drive and Low Boost, for adding per-voice grit, girth and distortion
- Three envelopes, two LFOs, and two AMS Mixers per OSC, plus a common LFO, Vector envelope, and KARMA for the Program as a whole
- Two complex key tracking generators per OSC, plus two more for the Program as a whole
- Extensive real-time modulation capabilities

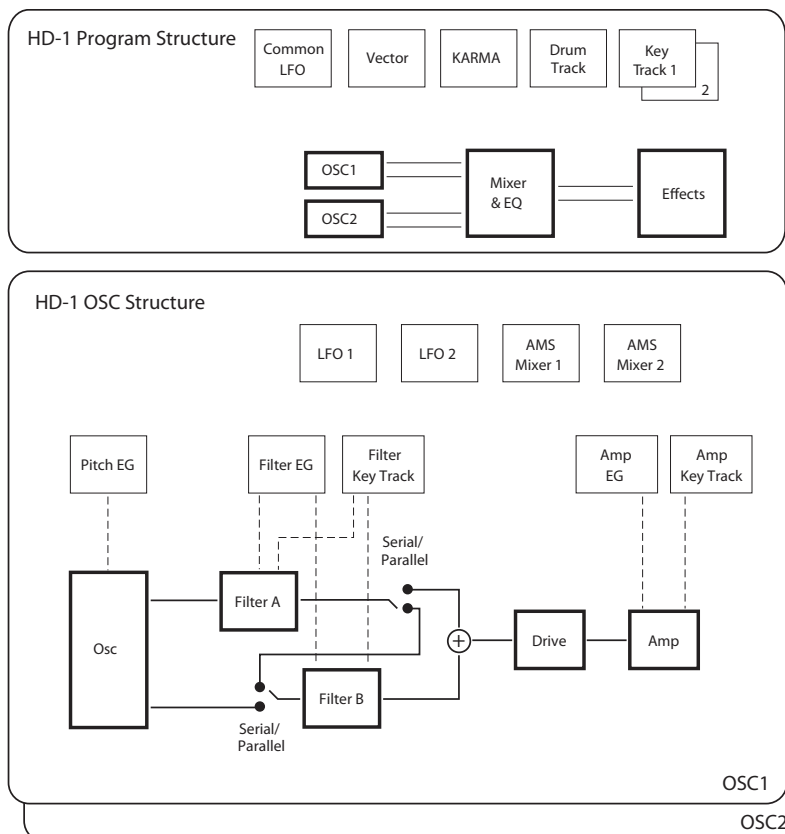

## Program P0: Play

This is the main page of Program mode for HD-1 Programs. Among other things, you can:

- Select Programs
- Jump directly to the main editing pages
- Make basic edits to KARMA
- Set up the audio inputs and resampling options
- Use the control surface

### Auto-Song Setup

This feature copies the current Program or Combination into a Song, and then puts the KRONOS in record-ready mode.

If inspiration for a phrase or song strikes you while you're playing, you can use this function to start recording immediately. To do so:

1. **Hold down the ENTER key and press the SEQUENCER REC/WRITE key.**

The Setup to Record dialog box will open and ask "Are you sure?"

2. **Press OK.**

You will automatically enter Sequencer mode, and will be in the record-ready state.

3. **Press the START/STOP key to start the sequencer and begin recording.**

## 0-1: Main

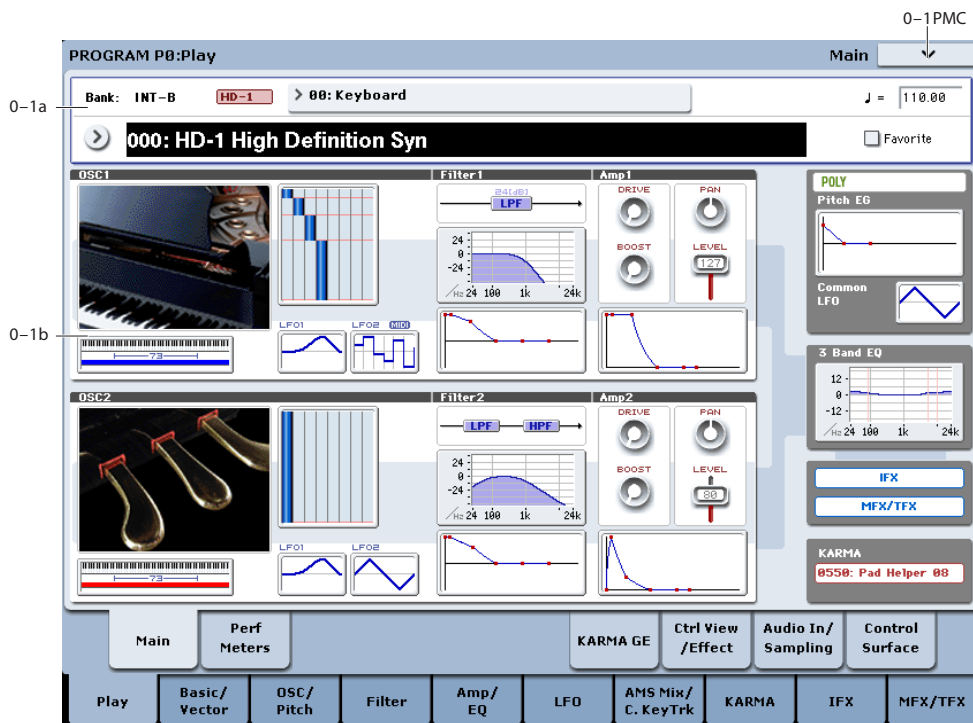

This is the main page for selecting Programs, which are the basic sounds of the KRONOS. It also includes an interactive overview of the most important Program parameters, such as envelopes, LFOs, Multisamples, filters, and so on. Just touch any of these overview areas, and you'll jump to the corresponding edit page.

*Tip:* Wherever you are in the Program mode pages, pressing EXIT three times (or fewer) will take you back to this page, and select the Program name. You can then immediately use the numeric keys or  $\Delta/\nabla$  switches to select a different Program.

For instance, if you're on any page other than P0: Play:

- Press it once to go to the previously-selected tab on the main P0 page, such as Control Surface or Audio In/Sampling.
- Press it again to go to the first tab on the main P0 page—the main Program Play page. If you had

previously selected a parameter on this page, that parameter will be selected.

- Press it a third time to select the main Program name parameter.

### 0-1a: Program Select

**Bank** [INT-A...F, GM, g(1...9), g(d), USER-A...G and AA...GG]

This is the Bank of the current Program. You can change the Bank either via the on-screen menu, or by using the front-panel Bank buttons.

To select banks INT-A...G or USER-A...G, simply press and release the corresponding BANK button.

To select banks USER-AA...GG, press and hold a pair of I and U BANK buttons together. For example, to select bank USER-CC, press and hold the I-C button,



and then press the U-C button. If you prefer, you can also press them in the opposite order: first U-C, and then I-C.

**Banks GM, g(1...9), and g(d): General MIDI**

The GM bank contains a full set of General MIDI 2 Programs, as well as variation sub-banks g(1)–g(9) (GM2 variation programs), and bank g(d) (drums).

Each time you press the front-panel INT-G button, you’ll step through these variation banks in the following order: GM→g(1)→g(2)…g(8)→g(9)→GM…

If a variation bank doesn’t have a different version of the current Program, the basic GM sound will be recalled instead. In this case, an asterisk \* will be added to the beginning of the Program name.

You can edit GM Programs, but you must then save them to a different Bank; the GM Programs themselves cannot be over-written.

**Program Bank Contents**

As shipped from the factory, the contents of the Program Banks are as follows:

*Program bank contents*

Bank	Contents	Bank Type
INT-A	SGX-1, EP-1, and “best of” all other EXi	EXi
INT-B...F	HD-1 Programs	HD-1
GM (I-G)	GM2 main Programs	GM
g(1)...g(9)	GM2 variation Programs	
g(d)	GM2 drum Programs	
USER-A	HD-1, including Ambient Drums and Sound Effects	Bank type can be set to either HD-1 or EXi
USER-B	AL-1	
USER-C	AL-1 and CX-3	
USER-D	STR-1	
USER-E	MS-20EX & PolysixEX	
USER-F	MOD-7	
USER-G	Initialized HD-1 Programs	
USER-AA...CC	Programs for EXs trial versions *	
USER-DD...EE	Initialized EXi Programs *	
USER-FF...GG	Initialized HD-1 Programs *	

\* Bank contents may differ depending on the KRONOS model.

For details on the factory Programs, please see the separate Voice Name List (VNL).

**Bank Type [HD-1, EXi]**

This shows whether the current Bank contains HD-1 Programs or EXi Programs. The two Program types can’t be mixed in a single bank.

**HD-1:** The Bank contains HD-1 Programs.

**EXi:** The Bank contains EXi Programs.

**Changing the Bank Type for USER Banks**

Banks can contain either HD-1 Programs or EXi Programs, but not both. This assignment is fixed for the INT banks, but can be set separately for each of the USER banks.

To change the type of a USER bank:

1. Press the front-panel GLOBAL button to enter Global mode.
2. Select the Basic tab.
3. Press the page menu button, and select Set Program User-Bank Type.
4. Change the Type for the desired banks. Leave all of the other banks set to “No Change.”

Setting a bank’s type will erase all of the Program data in the bank - so make sure that you’re not erasing any Programs you want to keep!

5. Press the OK button.

An “are you sure?” dialog appears.

6. If you’re certain of the change, press OK again.

The selected banks will now be initialized to use the new Program types.

**Program Select [0...127 (INT and USER Banks), 1...128 (GM Banks)]**

This is the current Program. When this parameter is selected, you can select programs using the Inc Δ and Dec ∇ buttons, numeric buttons 0-9 (followed by ENTER), or the Value dial.

You can also change Programs via MIDI Program Change message, or by pressing a footswitch. For more information, see “Foot Switch Assignments” on page 1106.

Standard Programs are numbered from 0 to 127, while GM Programs use the range from 1 to 128, as per the GM specification.

**Note:** On this page only, the VALUE slider functions as a modulation source - which means that you can’t use it to select Programs.

Press the popup button to call up the “Bank/Program Select” menu, as described below. This shows all of the Programs in memory, organized by Bank.

**Bank/Program Select**

1. Press the popup button at the left of “Program Select” to open the Bank/Program Select menu.

2. Press one of the tabs on the left to select a specific bank.

There are more banks than can be shown at one time, so the banks are divided into two groups of tabs: INT-A...USER-G and USER-AA...USER-GG.

3. If necessary, use the "More..." buttons below the tabs to switch between showing the tabs for INT-A...USER-G and USER-AA...USER-GG.

4. Select a program from the list. You can touch a Program's name directly, or use the Inc  $\Delta$  and Dec  $\nabla$  buttons.

The popup shows 16 Programs at a time. To browse through all of the Programs in the current bank, use the scroll bar at the bottom of the window.

When you select Bank INT-G, the **Variation** button appears at the bottom left of the dialog. This button cycles through the GM variation banks, just like repeatedly pressing the front-panel INT-G Bank button, as described under "Banks GM, g(1...9), and g(d): General MIDI," above.

The **Favorite** button trims the list to show only Programs you've marked as favorites. If the selected Bank contains no Programs marked as Favorites, the box can't be checked.

For more information, see "Favorite," below.

5. Press the OK button to confirm your choice, or press the Cancel button to exit without changing the Program.



**Category** [00...18, Name]

All programs are classified into one of eighteen categories, such as Keyboard, Organ, Strings, etc. Each of these categories may also have up to eight sub-categories.

Selecting by Category lets you search for a specific type of sound (like an electric bass, for example), without concern for what Banks the sounds are stored in.

Press the Category popup button, and the "Category/Program Select" menu will appear, as described below.



### Category/Program Select

1. Press the Category popup button (above the Program Select parameter) to open the Category/Program Select menu.
2. Press one of the tabs on the left to select the desired category.

If no Programs are assigned to a particular category or sub-category, you won't be able to select its tab.

3. Press a tab in the second from left column to select a sub-category.

**All:** All programs in the category will be shown. Choose this when you don't need to use sub-categories.

0...7: The programs will be shown by sub-category.

4. Select a program from the list.

You can touch a Program's name directly, or use the Inc  $\Delta$  and Dec  $\nabla$  buttons.

If there are more Programs than can be shown on the screen at one time, use the scroll bar to browse through the entire Category.

The **Favorite** check-box trims the list to show only Programs you've marked as favorites. If the selected Category contains no Programs marked as Favorites, the box can't be checked.

5. Press the OK button to confirm your choice, or press the Cancel button to exit without changing the Program.

You can assign a category to a Program in the "Write Program" dialog. For more information, see "Saving your edits" on page 42 of the Operation Guide, and "Writing Programs and Combinations" on page 182 of the Operation Guide.

### Favorite [Off, On]

This check-box, right under the Tempo parameter, marks the Program as a "favorite," which makes it easy to find in the Bank/Program Select and Category/Program Select dialogs.

**Important:** you must write the Program in order to save changes to the Favorite status.

### Tempo (♩) [040.00...300.00, EXT]

This is the tempo for the current Program, which applies to tempo-synced LFOs and Wave Sequences, the Vector EG, KARMA, and tempo-synced effects.

**EXT** means that the tempo will sync to external MIDI clocks. You'll see this if the Global MIDI page **MIDI Clock** parameter is set to **External MIDI or USB**, or if it's set to **Auto MIDI or USB** and the KRONOS is currently receiving MIDI clocks. For more information, please see "MIDI Clock (MIDI Clock Source)" on page 772.

040.00...300.00 allow you to set a specific tempo in BPM, with 1/100 BPM accuracy. In addition to using the standard data entry controls, you can also just turn the TEMPO knob, or by playing a few quarter-notes on the TAP TEMPO button.

## 0-1b: Overview and Page Jump

This section shows an overview of the most important Program settings, such as the selected Multisamples or Wave Sequences and their velocity ranges, filter settings, EGs and LFOs, and so on.

The graphics give you a quick way to check all of these settings at a glance. They also let you jump instantly to any of the displayed parameters. Just touch one of the graphics, and you'll jump to the page containing its parameters. For instance, if you touch the Filter EG graphic, you'll go to the Filter EG page.

### OSC1

#### OSC1 Graphic or Multisample/Wave Sequence/Drum Kit names

This area either shows the names of the Multisamples, Wave Sequences, or Drum Kit assigned to OSC1, or a graphic representing the type of sound.

Whether names or the graphic are displayed is controlled by the **Show MS/WS/DKit Graphics** menu command. For more information, see "Show MS/WS/DKit Graphics" on page 148 and "1-1h: Play Page MS/WS/DKit Display" on page 41.

If names are shown, colors and abbreviations are used to distinguish between various possibilities, as detailed below:

- Red: ROM, EXs, and User Sample Bank Multisamples
- Green: Sampling Mode Multisamples
- Blue: Wave Sequences
- Orange: Drum Kits
- Grey: Off
- Mn: Mono
- St: Stereo

Touch this area to jump to the corresponding Program P2- OSC1 Basic page.

#### Key Zone

This indicates the key zone in which OSC1 will sound. The 61-, 73- or 88-note keyboard region is also shown.

Touch this area to jump to the corresponding Program P1- Program Basic page.

#### MS1...8, Velocity Zone Graphic

This shows the velocity zones for OSC 1 multisamples 1-4.

Touch this area to jump to the corresponding Program P2- OSC1 Basic page.

#### OSC1 LFO1, OSC1 LFO2 Graphic

This shows the waveforms of OSC1 LFO1 and OSC1 LFO2. If "MIDI/Tempo Sync" is selected, this will indicate "MIDI."

Touch this area to jump to the corresponding Program P5- OSC1 LFO1 page or OSC1 LFO2 page.

### **Filter 1**

#### **Filter Routing & Type**

This shows the filter 1 routing and filter type.

Touch this area to jump to the corresponding Program P3– Filter1 page.

#### **Filter Page Graphic**

This shows the cutoff frequency.

Touch this area to jump to the Program P3– Filter1 page.

#### **Filter EG Graphic**

This shows the shape of the filter 1 EG.

Touch this area to jump to the corresponding Program P3– Filter1 EG page.

### **Amp 1**

#### **Drive, Low Boost, Pan, Amp Level**

This area shows the Amp 1 **Driver, Low Boost, Pan,** and **Amp Level** values.

If **Bypass** is on, **Drive** and **Low Boost** are not shown.

Touch this area to jump to the corresponding Program P4– Amp1/Drive1 page.

#### **Amp EG Graphic**

This shows the shape of the amp 1 EG.

Touch this area to jump to the corresponding Program P4– Amp1 EG page.

### **Common**

#### **Voice Assign Mode**

This shows the voice assign mode of the program—either POLY or MONO.

Touch this area to jump to the corresponding Program P1– Program Basic page.

#### **Pitch EG Graphic**

This shows the shape of the Pitch EG.

Touch this area to jump to the Program P2– Pitch EG page.

#### **Common LFO Graphic**

This shows the waveform of the Common LFO. Also, if **MIDI/Tempo Sync** is enabled, the word MIDI will appear.

Touch this area to jump to the Program P5– Common LFO page.

#### **3Band EQ Graphic**

This shows the MID-sweepable three-band EQ.

Touch this area to jump to the Program P4– EQ page.

### **IFX**

Touch this area to jump to the Program P8– Routing page.

### **MXF/TFX**

Touch this area to jump to the Program P9– Routing page.

### **KARMA**

This shows the name of the selected KARMA GE.

Touch this area to jump to the Program P7– GE Setup/Key Zones page.

---

## **▼ 0–1: Page Menu Commands**

The number before each command shows its ENTER + number-key shortcut. For more information on these shortcuts, see “ENTER + 0-9: shortcuts for menu commands” on page 147.

- **0: Write Program.** For more information, see “Write Program” on page 147.
- **1: Exclusive Solo.** For more information, see “Exclusive Solo” on page 147.
- **2: Show MS/WS/DKit Graphics.** For more information, see “Show MS/WS/DKit Graphics” on page 148.
- **3: Add to Set List.** For more information, see “Add To Set List” on page 148.



## 0-2: Performance Meters

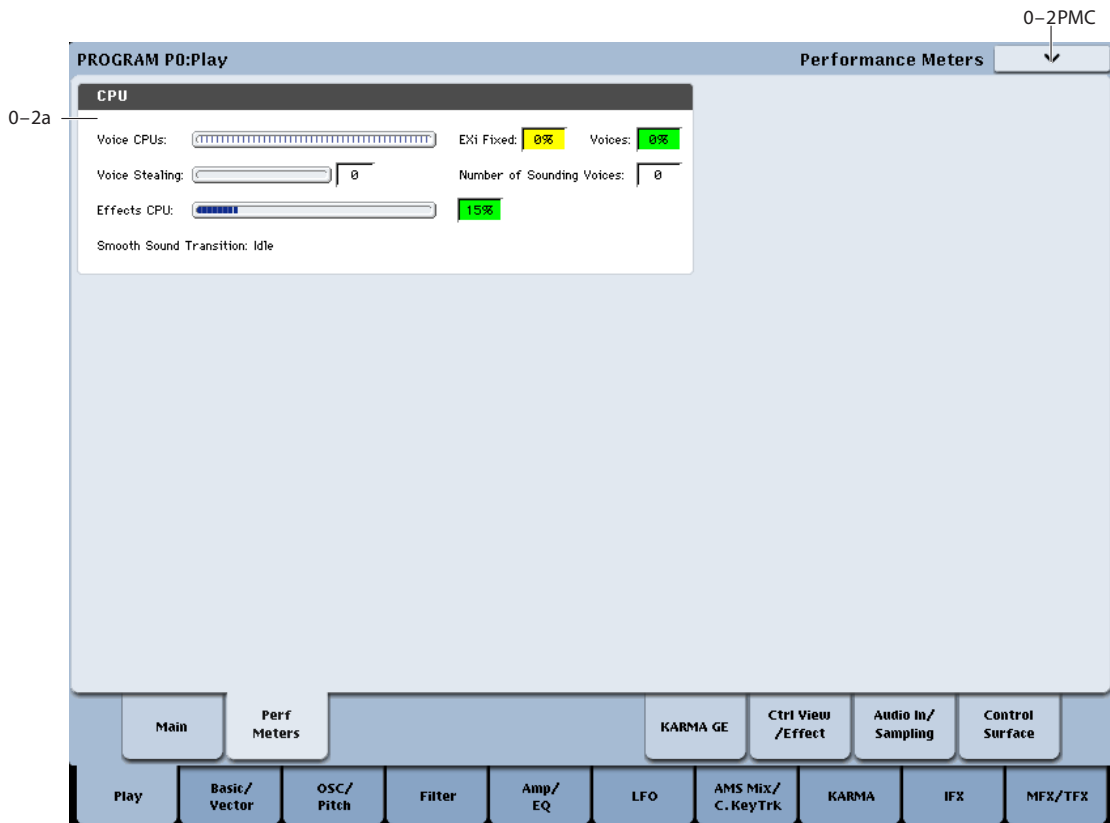

This page lets you look at the real-time performance of the KRONOS, including voice usage, voice stealing, and effects.

### 0-2a: CPU

#### Voice CPUs

This meter shows the amount of CPU power being used for playing voices. It uses two different colors to show the relative costs of voices and EXi fixed resources (see below). The relative percentage of each is shown numerically to the right of the meter graphic.

The figures shown are a real-time view of the actual CPU usage. Because of this, they may vary slightly even if you aren't changing anything. Also, due to the complex way in which the KRONOS uses the CPU, the figures may sometimes not change by much (or at all) when the number of voices changes by a small amount, or when you add or remove EXi with fixed resources.

**EXi Fixed:** This shows the amount of power used for EXi fixed resources, in yellow. "Fixed" means that part of the EXi starts using processing power as soon as the EXi is loaded, before playing any notes. These include effects built into the EXi, such as the amps and effects in the CX-3 and EP-1, as well as features shared by all voices, such as the MS-20EX's external signal processor. For more information, see "CX-3 & other EXi: Limitations on EXi fixed resources" on page 420.

**Voices:** This shows the amount of power used for currently-sounding voices, in green. This includes all HD-1 and EXi voices.

#### Voice Stealing

Sometimes, if a lot of voices are already sounding, there won't be enough free power to play a new voice. When this happens, the system stops older or lower-priority voices to free enough CPU power for the new voice. This is called "voice stealing." This meter shows the amount of voice stealing, in real time.

The KRONOS uses a complex, sophisticated system for voice stealing, which can stop voices from one synth (such as the HD-1) to make room for another (such as the PolysixEX). It also makes sure that you never have to worry about drop-outs from CPU "overs," as you do on most software systems.

In most cases, voice stealing will sound natural. Sometimes, however, you may notice that voices seem to be cutting off too early. If this occurs:

1. **Check this meter to see whether a lot of voice stealing is happening.**

If the meter doesn't show voice stealing, then the problem is being caused by something else. If the meter does show a lot of stealing, then you can address this in several different ways. Note that these solutions apply primarily to Combination and Sequencer modes.

2. **In Combination and Sequencer modes, use the Track/Timbre Priority setting to protect critical sounds from voice stealing.**

For more information, see "Timbre Priority" on page 454.

3. **Use the Max # of Notes setting to limit the polyphony of specific Timbres or Tracks, leaving more power for other sounds.**

For more information, see “Max # of Notes” on page 456.

4. In Sequencer mode, bounce high-polyphony MIDI Tracks to Audio Tracks, and then mute the MIDI Tracks.

### **Number of Sounding Voices**

This shows the total number of currently sounding voices. Voices will have different CPU costs depending on which of the synth engines they use. With double Programs, various HD-1 options (see below), and layers and crossfades in Combination and Sequencer modes, a single key on the keyboard may play a large number of voices.

In the HD-1, stereo samples use two voices each, Wave Sequences double the number of voices (two for mono, four for stereo), layered Oscillators (normal Double Programs, for instance) use separate voices for each Oscillator, and velocity cross-fades between MS use the total number of voices for both of the crossfaded sounds.

### **Effects CPU**

The KRONOS uses multiple CPUs for playing synthesizer voices, and a separate CPU for effects processing including IFX, MFX, and TFX. Note that effects integrated into EXi use the voice CPUs instead, and show up on the meters as EXi fixed resources, as described above.

This meter may also show activity reflecting the mixer infrastructure.

Note that effects continue to take up processing resources even when they are turned Off or bypassed. If you want to free up the processing resources, change the effect selection to 000: No Effect.

### **Smooth Sound Transition**

This shows whether or not the system is currently in the middle of a Smooth Sound Transition (SST). While an SST is occurring, the Effects CPU meter will generally show higher levels of activity than normal.

For more information, see “Smooth Sound Transitions” on page 120 of the Operation Guide.

**Idle** means that SST is not currently happening.

**Active** means that SST is in progress.

---

## **▼ 0–2: Page Menu Commands**

The number before each command shows its ENTER + number-key shortcut. For more information on these shortcuts, see “ENTER + 0-9: shortcuts for menu commands” on page 147.

- 0: **Write Program**. For more information, see “Write Program” on page 147.
- 1: **Exclusive Solo**. For more information, see “Exclusive Solo” on page 147.
- 2: **Show MS/WS/DKit Graphics**. For more information, see “Show MS/WS/DKit Graphics” on page 148.
- 3: **Add to Set List**. For more information, see “Add To Set List” on page 148.



## 0-6: KARMA GE

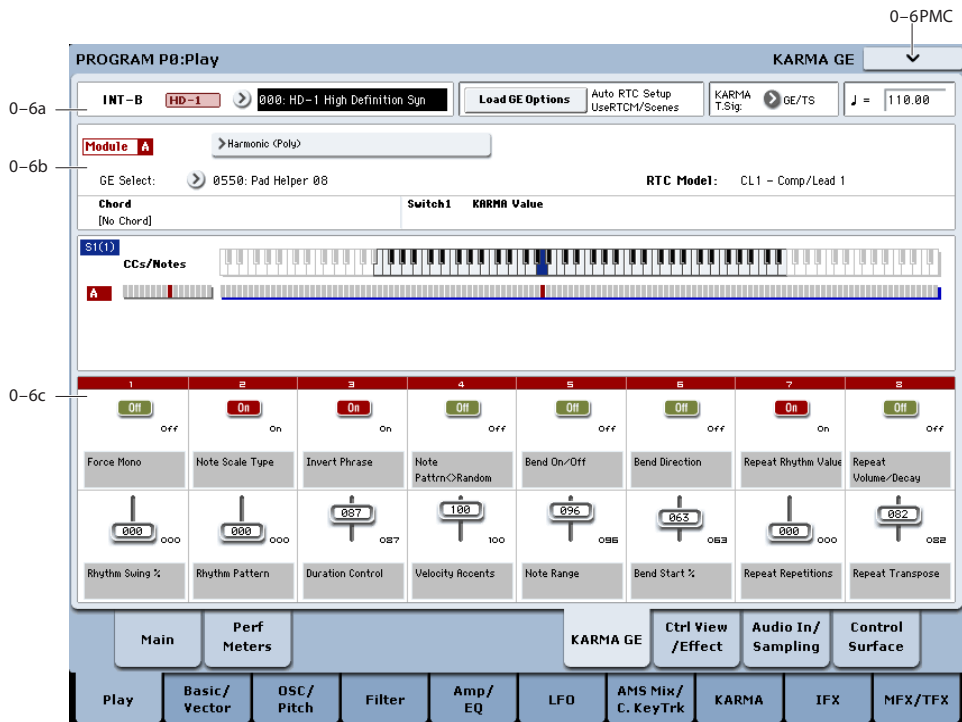

This page lets you make basic adjustments to KARMA. For more detailed editing of KARMA parameters, see “Program P7: KARMA” on page 107.

To enable or disable KARMA for the selected Program, use the KARMA ON/OFF switch.

The states of the KARMA ON/OFF and LATCH buttons, the selected KARMA SCENE, and KARMA SWITCHES 1-8 and SLIDERS 1-8 are saved independently for each Program.

### 0-6a: Program Select, Load GE Options, KARMA T.Sig, Tempo

**Bank** [INT-A...F, GM, g(1...9), g(d), USER-A...G and AA...GG]

**Bank Type** [HD-1, EXi]

**Program** [0...127 (INT and USER Banks), 1...128 (GM Banks)]

**J (Tempo)** [040.00...300.00, EXT]

These are the current bank, Program, and Tempo. For more information, see “0-1a: Program Select” on page 2.

### Load GE Options [Dialogue]

These options let you specify whether the values and assignments for the KARMA SLIDERS and SWITCHES will be set automatically, be initialized, or be preserved when you select a GE.

These options relate to the concept of RTC Models; for more information, see “RTC Model” on page 214 of the Operation Guide.

1. Press the Load GE Options button to open the Load GE Options dialog box.

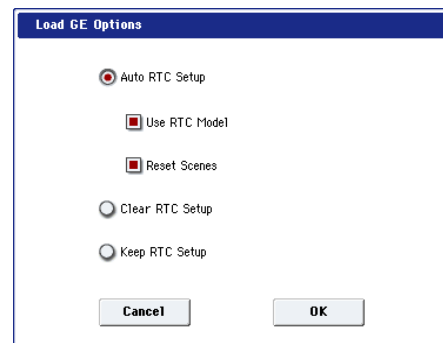

2. Specify how you want the KARMA controllers and scene settings to change (or be preserved) when you select a different GE.

**Auto RTC Setup:** When you select a GE, the settings for the KARMA SLIDERS and SWITCHES will be made automatically. This means that when you select a GE, you will be able to use the sliders and switches to control the phrases or effect variations without having to reassign the settings yourself.

**Clear RTC Setup:** When you select a GE, all KARMA controller and scene settings will be cleared (initialized). The Control Surface Sliders and Switches will have no effect on the GE.

**Keep RTC Setup:** Even if you select a GE, the current KARMA controller and scene settings will be preserved. Use this setting if you want to preserve the current KARMA controller and scene settings because you are selecting a GE whose assigned GE parameters are exactly the same (using the same RTC Model), or if you want to keep the

current KARMA controller settings and edit them yourself as necessary.

3. If you choose the **Auto RTC Setup On** setting, check or uncheck the “Use RTC Model” option box to specify how the automatic settings will be made.

**On (checked):** The current KARMA controller assignments and values will be cleared, and new settings will be made according to the RTC Model specified for each GE. However if you select a GE whose RTC Model is **Custom**, all KARMA controller and scene settings will be initialized (the same as if you’ve selected “Clear RTC Setup On”). Normally you will leave this on.

**Off (unchecked):** The current KARMA controller assignments and values will be preserved as much as possible. For example, you might select a drum pattern GE with this setting turned On (checked), edit some of the KARMA Scene settings appropriately for that GE, and then turn this Off (unchecked) when trying out a different drum pattern GE, thereby applying the settings you made to the new GE.

*Note:* If you turn on **Auto RTC Setup** and turn off **Use RTC Model**, the current KARMA controller settings will be preserved as much as possible, relative to the state of the GE Real-Time Parameters. However if (for example) the newly selected GE does not have the same realtime parameters, some of the KARMA controller settings will be cleared.

4. If you turned “Use RTC Model” On (checked), use “Reset Scenes” to specify whether scene settings will be reset or preserved when you select a GE.

**On (checked):** When you select a GE, the current settings of scenes 1–8 will be reset to the stored GE settings.

**Off (unchecked):** The current settings of Scenes 1–8 will be preserved. Choose this if you intend to select a different GE that has the same RTC Model and want to continue using the same scene settings.

 Even if this is Off (unchecked), the settings will be reset if you select a GE for which a different RTC Model is specified.

 If “Use RTC Model” is Off (unchecked), the “Reset Scene” option is unavailable.

5. Click the **OK** button to apply the settings of the dialog box, or click the **Cancel** button to return to the settings before you opened the dialog box.

**Note:** The RTC Model associated with a GE can be viewed on the Control Surface page when it is set to R.Time Knobs/KARMA, and in the VNL.

### KARMA T.Sig (Time Signature)

[GE/TS, 1/4...16/4, 1/8...16/8, 1/16...16/16]

This specifies the time signature of the phrases or patterns generated by the KARMA Modules. The internal time signature of the phrase or pattern is determined by the GE, but you can set this parameter to change the time signature.

**GE/TS:** The initial time signature specified by each KARMA Module will be used.

**1/4...16/16:** Specify the desired time signature. In Combination and Sequencer modes, this will change the time signature for all four KARMA Modules.

### Tempo (♩) [040.00...300.00, EXT]

This is the tempo for the current Program, which applies to tempo-synced LFOs and Wave Sequences, KARMA, and tempo-synced effects.

**EXT** means that the tempo will sync to external MIDI clocks. You’ll see this if the Global MIDI page **MIDI Clock** parameter is set to **External MIDI**, or if it’s set to **Auto** and the KRONOS is currently receiving MIDI clocks. For more information, please see “MIDI Clock (MIDI Clock Source)” on page 772.

**040.00...300.00** allow you to set a specific tempo in BPM, with 1/100 BPM accuracy. In addition to using the standard data entry controls, you can also just turn the TEMPO knob, or by playing a few quarter-notes on the TAP TEMPO button.

---

### 0–6b: GE Select

The phrases and patterns produced by a KARMA Module are generated by a **GE (Generated Effect)**. Based on input note data from the keyboard, the GE creates phrases and patterns using numerous internal parameter settings to control the development of the note data, the rhythm, the chord structure, the velocity etc. MIDI control changes and pitch bend etc. can also be generated in synchronization with the phrase or pattern. In this way you can produce phrases and patterns in which the GE freely varies the tone or pitch. The GE can be selected independently for each KARMA Module.

In Program mode you can use one KARMA Module (Module A). In Combination and Sequencer modes, you can use four KARMA Modules: A, B, C, and D.

### Module A

#### GE Select [Preset 0000...2047, USER-A...L 000...127]

This selects the GE for the KARMA module. There are a total of 3,584 to choose from: 2,048 preset GEs, and 1,536 rewritable User GEs (12 banks of 128 each).

Preset GEs are part of the system software.

User GEs may be included with new banks of sounds, and can also be created using KARMA KRONOS software (dedicated software for the KRONOS\*). For more information on loading User GEs, see “Load .KGE” on page 843.

\* Made by Karma La1b (<http://www.karma-lab.com>). Macintosh and Windows are supported. English version only.

#### GE Bank Select [Preset...USER-L]

This selects the GE bank. The Preset bank is part of the system software; User banks can be loaded from disk. For more information, see “GE Select,” above.

#### GE Category Select [Arpeggio...Real-Time]

This lets you select a GE by category, from **Arpeggio** through **Real-Time**.

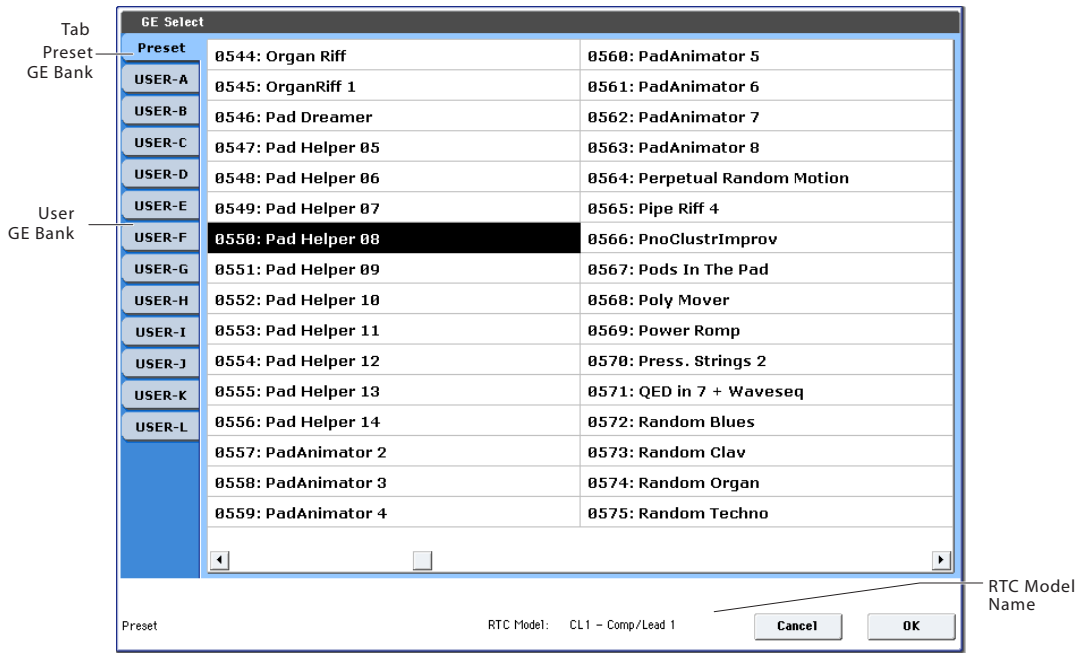

**RTC Model**

**[List of RTC Models]**

This shows the GE’s RTC Model, as specified internally for each preset GE.

RTC stands for “Real Time Control.” RTC models provide a level of standardization for controlling the over 200 internal parameters of a GE. For more information, see “RTC Model” on page 214 of the Operation Guide.

**KARMA Module Info**

**Chord**

**[Chord name]**

This shows the name of the chord detected by the KARMA Module.

Note: Chord detection is affected by the following parameters:

- The KARMA module’s **Key Zone**. See “Key Zone” on page 108.
- The KARMA module’s **Transpose**. See “Transpose” on page 113.
- The **Destination** (Dynamic MIDI Destination). See “Destination” on page 129.
- The **Chord Scan** and **Smart Scan** settings.

**KARMA Value**

When you move or press a KARMA SLIDER or SWITCH, this area shows the number and value of the GE Real-Time Parameters or Perf Real-Time Parameters assigned to the control. This lets you see which parameters are being controlled by the slider or switch, and how.

*Display example*

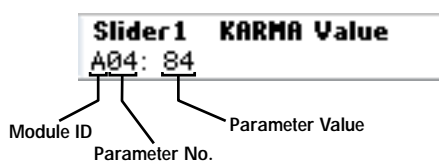

**(Module ID)**

**[A, P]**

This shows the type of parameter assigned to the slider or switch.

**A:** KARMA Module A is being controlled. In this case, you are controlling a GE Real-Time Parameter.

**P:** The slider or switch is controlling a Perf Real-Time Parameter.

**(Parameter Number)**

**[01...32]**

When **Module ID** is **A**, this shows the number of the assigned GE Real-Time Parameter (01...32). These parameters are assigned to controls on the 7-5: GE Real-Time Parameters page.

If **Module ID** is **P**, this shows the number of the assigned Perf Real-Time Parameter (01...08). These parameters are assigned to controls on the 7-6: Perf Real-Time Parameters page.

**Parameter Value**

This area shows the current value of the GE Real-Time Parameter or Perf Real-Time Parameter. This will change as you move the slider or operate the switch.

⚠ A slider or switch can have many parameters assigned to it. A maximum of five assigned parameters can be displayed here in the available space. They will still function when the control is activated, even though you can’t view their values directly.

**Note/CC Activity**

**A (Module A)**

**S (Scene)**

**[1...8]**

The blue square in the upper left of the section shows the current scene of the selected KARMA module.

The number in parentheses is the default Scene, as stored in the Program.

### CCs/Notes

This is a realtime display of the note-on/off or MIDI control change messages generated by the KARMA module (Module A).

### Scan Zone

The Key Zone of the KARMA Module is displayed as a solid blue line under the notes display. For more information, see “Key Zone” on page 108.

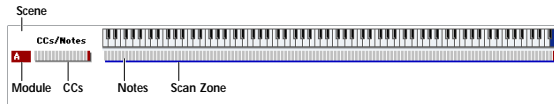

- 2: **Copy KARMA Module.** For more information, see “Copy KARMA Module” on page 155.
- 3: **Initialize KARMA Module.** For more information, see “Initialize KARMA Module” on page 156.
- 4: **Copy Scene.** For more information, see “Copy Scene” on page 157.
- 5: **Swap Scenes.** For more information, see “Swap Scene” on page 157.
- 6: **Capture Random Seed.** For more information, see “Capture Random Seed” on page 157.
- 7: **Auto Assign KARMA RTC Name.** For more information, see “Auto Assign KARMA RTC Name” on page 148.
- 8: **Add to Set List.** For more information, see “Add To Set List” on page 148.

---

## 0–6c: RealTime Controls

This displays the values, names, and stored settings of KARMA SLIDERS 1–8 and KARMA SWITCHES 1–8. Note that each Scene can have separate values and stored settings for each of the sliders and switches.

### KARMA SWITCHES 1...8

#### Current Value 1...8

This shows the current setting of the KARMA SWITCH. You can control this either by using the physical front-panel switch, or by touching the on-screen switch.

#### Stored Value 1...8

This shows stored value of the KARMA SWITCH for the current Scene, as written into the Combination.

#### Name 1...8

This shows the name of the KARMA SWITCH. You can assign this name in Program 7–9: Name/Map.

### KARMA SLIDERS 1...8

#### Current Value 1...8

This shows the current setting of the KARMA SLIDER. You can change this either by using the physical front-panel slider, or by touching the on-screen slider and then using any of the data-entry controls.

#### Stored Value 1...8

This shows stored value of the KARMA SLIDER for the current Scene, as written into the Combination.

#### Name 1...8

This shows the name of the KARMA SLIDER. You can assign this name in Program 7–9: Name/Map.

---

## ▼ 0–6: Page Menu Commands

The number before each command shows its ENTER + number-key shortcut. For more information on these shortcuts, see “ENTER + 0-9: shortcuts for menu commands” on page 147.

- 0: **Write Program.** For more information, see “Write Program” on page 147.
- 1: **Exclusive Solo.** For more information, see “Exclusive Solo” on page 147.

## 0-7: Controller View/Effect

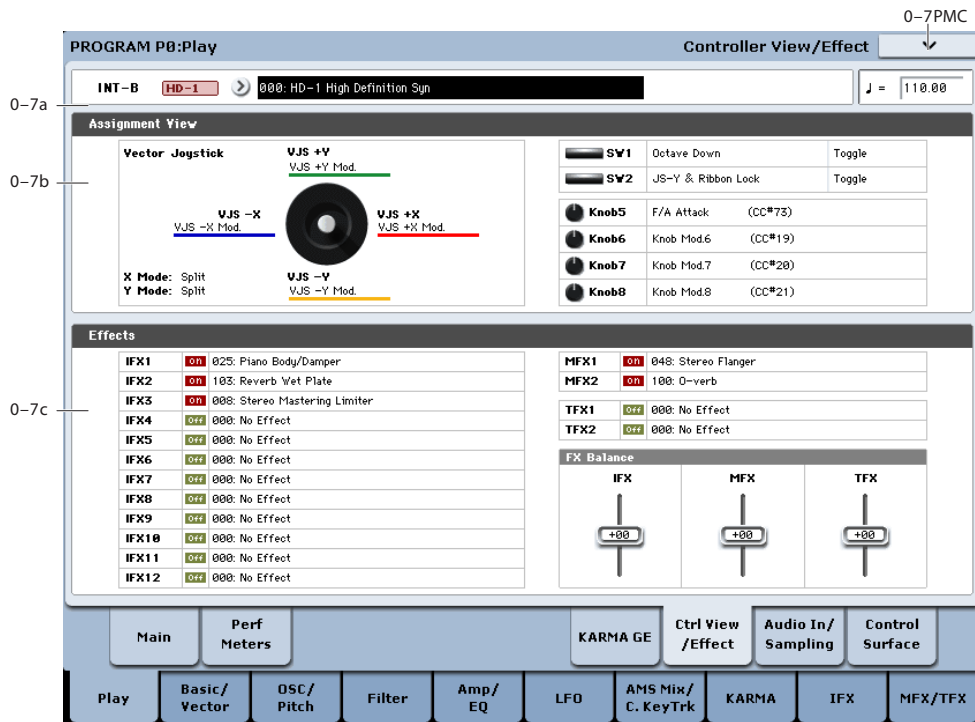

This page shows the functions assigned to the physical controllers, including the vector joystick, SW1 and 2, and knobs 5-8. It also includes an overview of all of the effects, and lets you adjust the Wet/Dry Balances separately for the IFX, MFX, and TFX.

### 0-7a: Program Select

**Bank** [INT-A...F, GM, g(1...9), g(d), USER-A...G and AA...GG]

**Bank Type** [HD-1, EX*i*]

**Program** [0...127 (INT and USER Banks), 1...128 (GM Banks)]

**♩ (Tempo)** [040.00...300.00, EXT]

These are the current bank, Program, and Tempo. For more information, see "0-1a: Program Select" on page 2.

### 0-7b: Controller View

#### VJS

This area shows information about the vector joystick.

**X Mode, Y Mode:** These indicate the behavior of the vector CC for the X-axis and Y-axis. For more information, see "VJS X Mode" on page 48.

**VJS +X, VJS -X, VJS +Y, VJS -Y:** These indicate the controller transmitted by the +X, -X, +Y, and -Y vectors. For more information, see "+X" on page 48.

#### SW1, SW2, Knob5...8

##### SW1&2

[Assignment]

These indicate the functions assigned to SW1 and 2.

##### Knobs 5...8

[Assignment]

These indicate the functions assigned to knobs 5-8. (See "1-8: Set Up Controllers" on page 53)

### 0-7c: Effects

#### IFX1...12, MFX1&2, TFX1&2

[Effect]

This area shows the effect assigned to each insert effect, master effect, and total effect, and its on/off status.

#### FX Balance

##### IFX

[-10...0...+10]

This controls the "Wet/Dry" balance of all insert effects. A setting of +10 is Wet or -Wet, a setting of +0 leaves the settings of the program unmodified, and a setting of -10 is Dry.

##### MFX

[-10...0...+10]

This controls the MFX1 and 2 "Return." A setting of +10 is 127, a setting of +0 leaves the settings of the program unmodified, and a setting of -10 is 000.

##### TFX

[-10...0...+10]

This controls the "Wet/Dry" balance of TFX1 and 2. A setting of +10 is Wet or -Wet, a setting of +0 leaves the settings of the program unmodified, and a setting of -10 is Dry.

When you edit these settings, the change will occur immediately in the sound, but the values of the original program parameters will not change until you save the program. When you save the program, the values will be updated and these sliders will be reset to 0.

- **0: Write Program.** For more information, see “Write Program” on page 147.
- **1: Exclusive Solo.** For more information, see “Exclusive Solo” on page 147.
- **2: Show MS/WS/DKit Graphics.** For more information, see “Show MS/WS/DKit Graphics” on page 148.
- **3: Add to Set List.** For more information, see “Add To Set List” on page 148.

### ▼ 0-7: Page Menu Commands

The number before each command shows its ENTER + number-key shortcut. For more information on these shortcuts, see “ENTER + 0-9: shortcuts for menu commands” on page 147.

## 0-8: Audio Input/Sampling

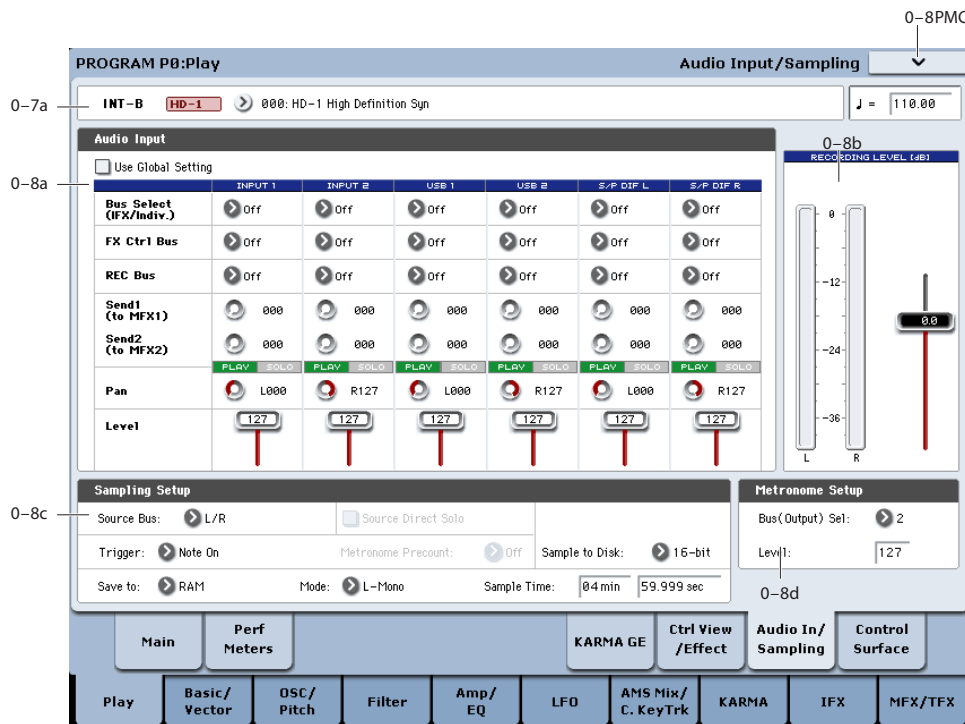

This page lets you adjust the volume, pan, effects sends, and bussing for the audio inputs, including analog inputs 1 & 2, USB 1 & 2, and S/P DIF L & R. It also controls the sampling-related settings for Program mode.

The KRONOS can sample external audio any of the inputs, at 48 kHz 16-bit resolution (or 24-bit when sampling to disk), in mono or stereo. You can record samples into RAM for use in Sampling Mode, or sample directly to disk.

You can also digitally resample the complete sound of a Program, played polyphonically, live or sequenced, including any effects and KARMA-generated events.

Finally, you can also use the KRONOS as a 6-in, 6-out audio processor. You can process the inputs through the IFX, MFX, and TFX, or through the synthesis functions of EXi such as the MS-20EX and MOD-7.

You can combine any and all of these features at once. For instance, you can sample a live guitar riff from the audio inputs, processed through KRONOS effects, while listening to and either recording or not recording a KARMA-generated phrase.

### Using the control surface with the Audio Inputs

You can use the control surface to adjust most of the Audio Input mixer parameters, including **Play/Mute**, **Solo**, **Pan**, **Level**, and **Sends 1 and 2**.

For more information, see “0-9c: Audio Inputs” on page 25, and “Adjusting volume, Pan, EQ, and FX sends” on page 39 of the Operation Guide.

### 0-8a: Audio Input

#### Use Global setting

[Off, On]

Each Program can either use the single, Global audio input mixer setup, or have its own custom settings. The Global settings are described under “0-2: Audio Input,” on page 759.



When **Use Global Settings** is **On**, the Program uses the Global settings. This is the default, and lets you change freely between different Programs, Combis, and Songs without affecting the audio inputs.

Also, any edits made on this page will affect the Global setting, along with any other Programs, Combis, or Songs which use the Global setting.

On the other hand, it may sometimes be convenient to save a particular mixer setup with an individual Program, Combi, or Song, to set up special sub-mixer settings or effects processing for particular inputs. For example, you can set up a Program to use a mic input with a vocoder, as described under “Vocoder (Program mode)” on page 861.

In this case, set **Use/Edit Global Setup** to **Off**, and the audio inputs will use the Program’s custom settings.

### Input 1 & 2

These are settings for the analog inputs.

### USB 1 & 2

These are settings for the USB inputs.

### S/P DIF L & R

These are settings for the S/P DIF digital audio input, for connecting external A/D converters, computer audio systems, DAT machines, or other digital audio gear.

KRONOS supports S/P DIF input at 48 kHz.

⚠ When using S/P DIF, make sure that the Global mode’s **System Clock** parameter is set appropriately. For more information, see “System Clock” on page 756.

**Bus Select (IFX/Indiv.)** [L/R, IFX1...12, 1...4, 1/2...3/4, Off]

This sets the output bus for the external audio input signal. You can send the audio directly to physical outputs, or to the insert effects.

**L/R:** The external audio input signal will be sent to the L/R bus.

**IFX1...12:** The external audio input signal will be sent to the IFX1–12 bus. Choose one of these settings if you want to apply an insert effect while sampling.

**1...4:** The external audio input signal will be sent in mono to INDIVIDUAL outputs 1–4. Pan does not apply in this case.

**1/2...3/4:** The external audio input signal will be sent to the selected pair of outputs in stereo, with the stereo position controlled by the **Pan** parameter

**Off:** The external audio signal will not be used.

**FX Ctrl Bus (FX Control Bus)** [Off, 1, 2]

This lets you send the audio input to one of the two stereo FX Control busses. See “FX Control Buses” on page 860.

**REC Bus** [Off, 1...4, 1/2, 3/4]

This sends the external audio input signal to the REC busses (four mono channels; 1, 2, 3, 4).

Using the REC busses, you can isolate one or more sounds for recording or sampling—even if the sounds are also being mixed into the main outputs. For example, you can play a guitar through KRONOS IFX while listening to a KARMA drum phrase, and record the processed guitar without recording the drums.

Individual Programs, Combi Timbres, Sequencer Tracks (both MIDI and Audio), audio inputs, and Insert Effects can all be routed to the REC busses, in addition to their main output/IFX bus settings.

You can sample these signals by setting the sampling **Source Bus** (0–8c) to REC bus.

For more information, see the diagram “Source Bus = REC Bus 1/2” on page 18.

**Off:** The external audio signal will not be sent to the REC busses. Normally you will use the Off setting.

**1, 2, 3, 4:** The external audio input signal will be sent to the specified REC bus. The **Pan** setting is ignored, and the signal is sent in monaural.

**1/2, 3/4:** The external audio input signal will be sent in stereo to the specified pair of REC busses. The **Pan** setting sends the signal in stereo to busses 1 and 2 or busses 3 and 4.

**Send1 (to MFX1)** [000...127]

**Send2 (to MFX2)** [000...127]

These adjust the levels at which the external audio input signal is sent to the master effects.

**Send1 (to MFX1):** Send the signal to master effect 1.

**Send2 (to MFX2):** Send the signal to master effect 2.

If **Bus Select (IFX/Indiv. Out Assign)** is set to IFX1–12, the send levels to the master effects are set by the post-IFX1–12 **Send1** and **Send2** (8–2a). For more information, See “Analog, USB, and S/P DIF inputs” on page 872.

*Tip:* You can use the control surface to control this parameter. For more information, see “Using the control surface with the Audio Inputs” on page 14.

**PLAY/MUTE** [Play, Mute]

This shows whether the input is in PLAY or MUTE status.

You can use the MIX PLAY/MUTE 1–6 switches to change this.

**Mute:** The input sound will be muted (silent).

**Play:** The input sound will be heard.

*Tip:* You can use the control surface to control this parameter. For more information, see “Using the control surface with the Audio Inputs” on page 14.

**SOLO On/Off**

Solo lets you isolate one or more Oscillators or audio inputs, so that you hear them by themselves. It does this by temporarily muting all non-soloed Oscillators and audio inputs.

The way in which Solo operates depends on the setting of the **Exclusive Solo** menu command. For more information, see “Exclusive Solo menu parameter” on page 24.

 The SOLO setting is not stored when you Write a Program.

*Tip:* You can use the control surface MIX SELECT 1–6 switches to control this parameter. For more information, see “Using the control surface with the Audio Inputs” on page 14.

**Pan** [L000...C064...R127]

This specifies the panning of the audio input. When using two inputs for a stereo audio source, you’ll normally set the inputs to L000 and R127 respectively.

*Tip:* You can use the control surface to control this parameter. For more information, see “Using the control surface with the Audio Inputs” on page 14.

**Level** [000...127]

This controls the level of the external audio signal. The default is 127.

The analog audio signals from AUDIO INPUTS 1–4 are converted into digital form by an A/D converter. This parameter sets the level of the signal immediately after this conversion.

If the sound is distorted even though this level setting is very low, see “Tips for eliminating distortion when using the analog inputs,” below.

*Tip:* You can use the control surface to control this parameter. For more information, see “Using the control surface with the Audio Inputs” on page 14.

**Avoiding extraneous noise**

 If audio cables are connected to AUDIO INPUTS 1–4, any noise carried by the cables will enter into the KRONOS mixer structure. Similarly, the S/P DIF input may carry noise from external devices. This may include hiss, hum, and other audio noise.

To avoid noise from unused audio inputs, either:

- Set the input’s **Level** to 0  
or
- Set all of the bus assignments to Off, including **Bus Select (IFX/Indiv. Out Assign)**, **REC Bus**, and **FX Control Bus**

If no audio cables are connected to AUDIO INPUTS 1–4, the input signals are forced to zero, preventing any additional noise.

**ADC OVERLOAD!**

If the signal level from the analog audio inputs is too high, the “ADC OVERLOAD!” indication will appear. You’ll need to adjust the MIC/LINE gain select switches and/or LEVEL knobs, or the output level of your external audio source.

**0–8b: Recording Level [dB]**

**Recording Level** [-Inf, -72.0...+0.0...+18.0]

This adjusts the signal level at the final stage of sampling.

The Recording Level setting is made for Program mode as a whole, and is not saved independently with each Program.

**Level Meter**

This shows the signal level at the final stage of sampling, after any adjustments on the Audio Inputs page, any effects, etc. The meter is active only during standby mode and recording.

**CLIP!**

If 0 dB is exceeded, the display will indicate “CLIP!” This means that the level of the sampling signal is too high; in this case, adjust the Recording Level, and if necessary follow the instructions under “Tips for eliminating distortion when using the analog inputs,” below.

**Setting levels**

For the best results, set the levels as described below:

1. Press the **SAMPLING REC** switch. KRONOS will enter sampling standby mode, and the **Level Meter** becomes active.
2. Initially, set the **Recording Level** to 0.0dB.
3. Adjust the level of the input signal so that it is as high as possible without activating the **CLIP!** or **ADC OVERLOAD!** messages.

If you’re using AUDIO INPUTS 1 and/or 2, adjust the volume using rear-panel MIC/LINE switches and LEVEL knobs.

If you’re using AUDIO INPUT 3 and/or 4, or the S/P DIF input, adjust the output level of your external audio source.

*Audio input/output*

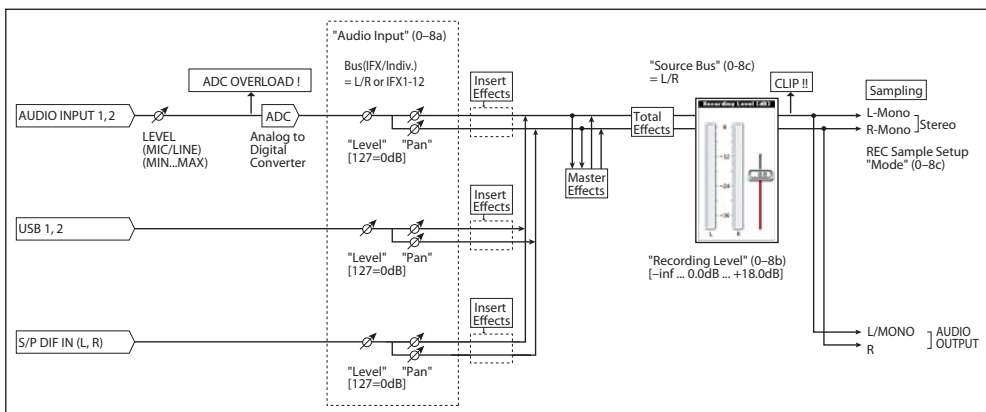



If you're sampling external audio through the internal effects, you may also need to adjust the individual effects input and/or output level parameters.

If you're using internal sounds, adjust the levels using the control surface, effects input/output trim, etc.

**4. If the level is still not high enough, increase the Recording Level using the on-screen slider.**

Again, the goal is to get the level as high as possible without activating the CLIP! or ADC OVERLOAD! messages.

**Tips for eliminating distortion when using the analog inputs**

If sound from the analog inputs is distorted, but the CLIP! message doesn't appear, it's possible that distortion is occurring at the analog input stage, or that distortion is being caused by the settings of the internal effects.

If the "ADC OVERLOAD!" message appears above the **Recording Level** meters, the distortion is due to excessive levels at the input. In this case, either lower the output level of the external audio source, or (for inputs 1 and 2 only) adjust the MIC/LINE gain select switch and LEVEL knob so that this message does not appear.

If there is distortion, but the "ADC OVERLOAD!" message does not appear, it's possible that the distortion is being caused by the settings of the internal effects. To solve this problem, either lower the input **Level** (see "Level," above), or adjust the effects settings (such as changing the individual effect Input Trim parameters).

When you sample from an output pair or REC bus, you'll record all audio sent to the output or bus, including internal Programs or Combis, effects, audio inputs, and HDR audio.

When sampling in stereo, the odd-numbered channel (such as 1 or 3) corresponds to the left channel, and the even-numbered channel (such as 2 or 4) corresponds to the right.

**L/R:** This lets you sample the signal heard at the main L/R outputs, including any processing by TFX 1/2. This is the default setting. For more information, see the diagram "Source Bus = L/R" on page 17.

**REC1/2, REC3/4:** These let you sample the signals sent to the REC 1/2 or REC 3/4 busses.

Using the REC busses, you can isolate one or more sounds for recording or sampling—even if the sounds are also being mixed into the main outputs. For example, you can play a guitar through KRONOS IFX while listening to a KARMA drum phrase, and record the processed guitar without recording the drums.

Individual Programs, Combi Timbres, Sequencer Tracks (both MIDI and Audio), audio inputs, and Insert Effects can all be routed to the REC busses, in addition to their main output/IFX bus settings.

For more information, see the diagram "Source Bus = REC Bus 1/2" on page 18.

**Audio Input 1/2, S/P DIF L/R, USB:** These let you sample directly from the analog, S/P DIF, or USB audio inputs, respectively, without any other processing by KRONOS. The settings on the Audio Inputs mixer, including volume, pan, busses, sends, mute, and solo, will have no effect on the recorded audio.

For more information, see the diagram "Source Bus = Audio Input 1/2" on page 18.

For more information, see the diagram "Source Bus = USB 1/2" on page 18.

**Indiv.1/2...3/4:** This lets you sample the individual output busses. For more information, see the diagram "Source Bus = Indiv. 1/2" on page 19.

**0–8c: Sampling Setup**

**Source Bus [Audio Input1/2, USB 1/2, S/P DIF L/R, L/R, REC1/2...3/4, Indiv.1/2...3/4]**

You can sample in stereo from any pair of audio inputs, from the two stereo REC busses, or from the signal at any of the 6 outputs (L/R and Individual 1/2-3/4).

Source Bus = L/R

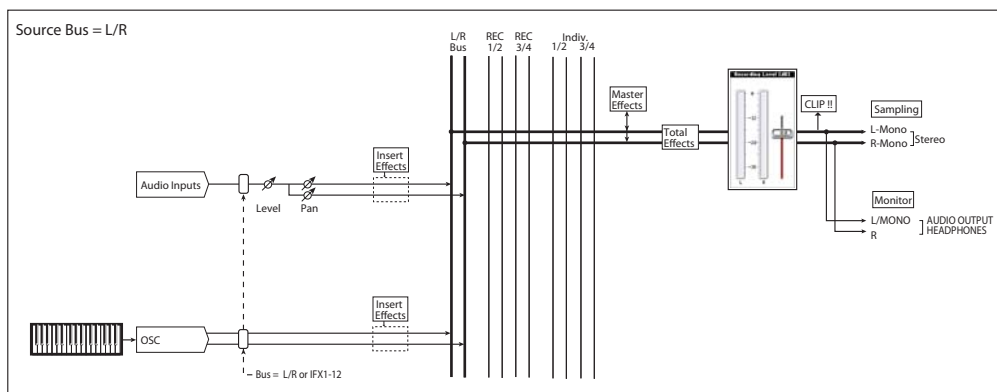

**Program mode: HD-1**

Source Bus = REC Bus 1/2

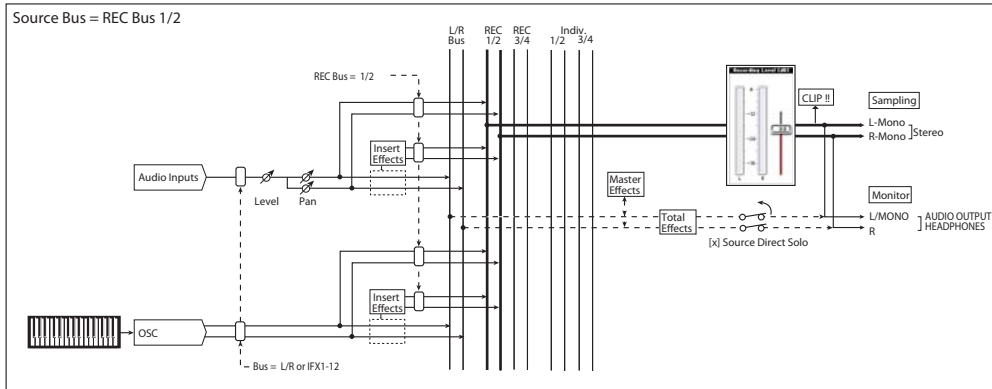

Source Bus = Audio Input 1/2

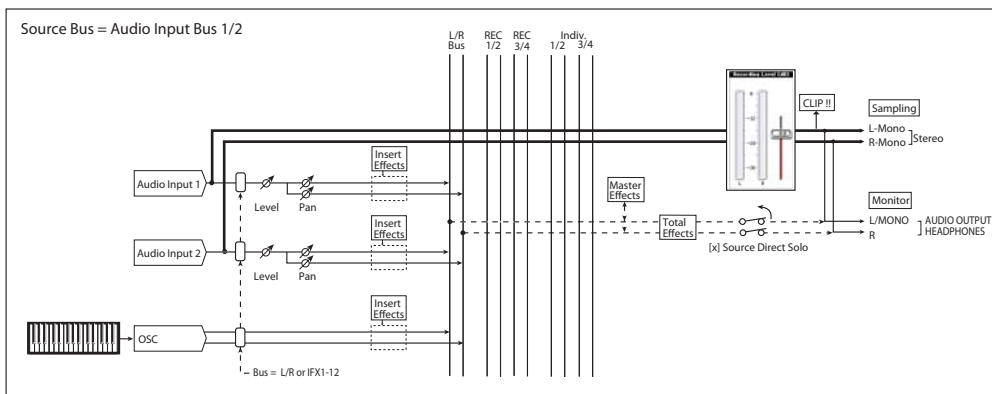

Source Bus = USB 1/2

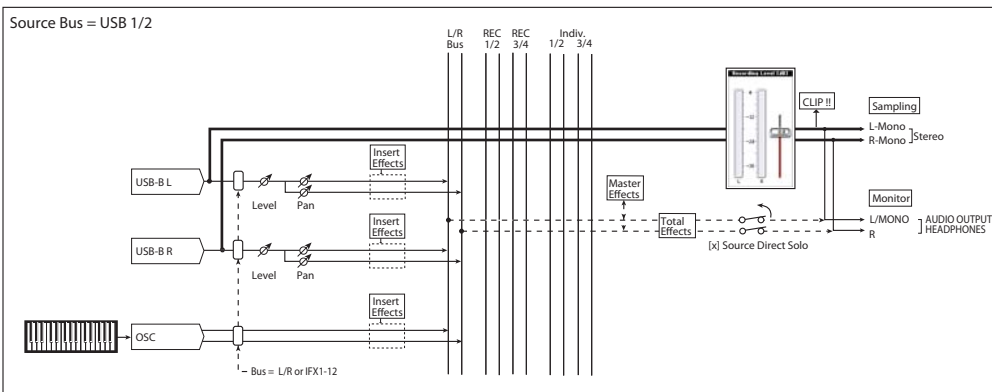

Source Bus = S/P DIF L/R

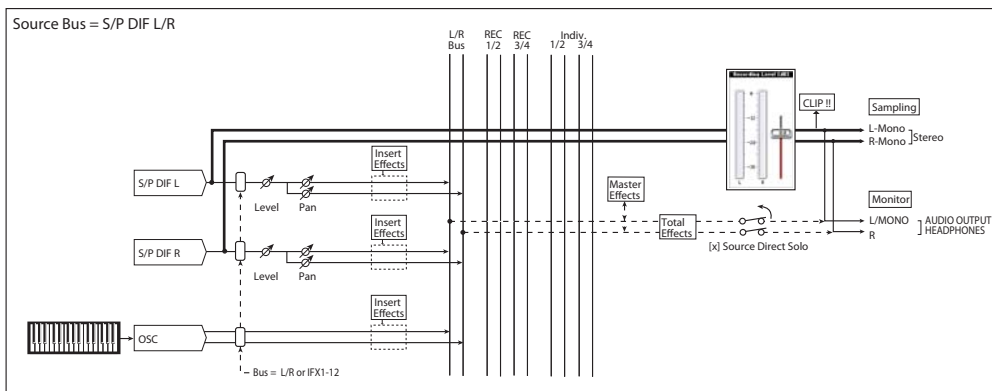

Source Bus = Indiv. 1/2

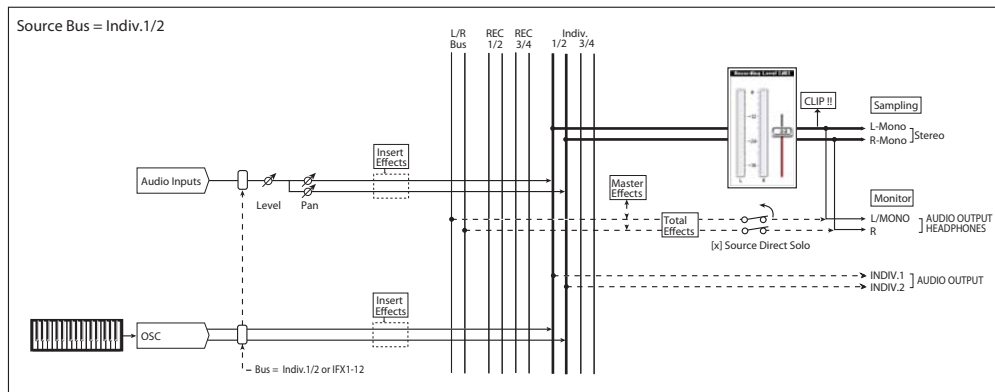

**Source Direct Solo [Off, On]**

This selects what is heard through the L/R outputs and headphones when Sampling REC is enabled.

**On (checked):** Only the signal of the selected **Source Bus** will be heard. This lets you hear only the sound that will be sampled.

**Off (unchecked):** The signal of the selected **Source Bus** will be merged with the main L/R signal. This is the default.

*Note:* If **Source Bus** is set to **L/R**, this setting is ignored—since that signal is normally heard at the L/R outputs already!

**Trigger [Sampling START SW, Note On]**

Specifies how sampling will be initiated.

**Sampling START SW:** Pressing the SAMPLING REC switch will cause the KRONOS to enter sampling-standby mode, and sampling will begin when you press the SAMPLING START/STOP switch.

**Note On:** Press the SAMPLING REC switch and then press the SAMPLING START/STOP switch to enter sampling-standby mode. Sampling will begin when you play the keyboard.

**MIDI** Sampling will also begin if a MIDI note-on is received (instead of playing the keyboard).

Regardless of the settings you’re using, press the SAMPLING START/STOP switch once again when you’ve finished sampling. Alternatively, sampling will end automatically if the specified “Sampling Time” elapses.

**Metronome Precount [Off, 4, 8, 3, 6]**

This specifies whether the metronome will sound a count-down before sampling begins. This can be set only if “Trigger” is set to Sampling START SW.

**Off:** Sampling will begin immediately when you press the SAMPLING START/STOP switch from recording-standby mode.

**4, 8, 3, 6:** When you press the SAMPLING START/STOP switch from recording-standby mode, the metronome will count the specified number of beats at the system tempo, and then sampling will begin. If you set this to 4, sampling will begin on the count of 0 after a pre-count of 4–3–2–1–0.

The output destination and level of the metronome sound are specified by Metronome Setup (0–8d). If “Bus (Output) Select” is set to L/R, the metronome will stop sounding the instant sampling actually begins.

**Save to [RAM, DISK]**

Specifies the destination to which the data will be written during sampling.

**RAM:** The sound will be sampled into RAM for use in Sampling mode. The **Select Sample No.** menu command lets you specify the Sample numbers to use, enable **Auto +12dB**, and make settings for automatic conversion to a Program. For more information, see “Select Sample No.” on page 149.

*Note:* The amount of RAM available for Sampling mode is shown by Free Sample Memory/Locations (Sampling 0–1f). The amount of RAM available will vary depending upon both the amount of physical RAM installed, and the size of the currently loaded EXs and User Sample Banks. For more information, see “Sampling and RAM” on page 675.

**⚠** Samples saved to RAM will be lost when the power is turned off, so you must save them if you want to keep them.

**DISK:** Samples will be recorded to the internal disk or a USB storage device.

When you sample, a WAVE file is created on the disk. Use the **Select Directory/File for Sample to Disk** page menu command to specify the writing-destination disk and directory.

To open the resulting sample, you can either use Disk mode to load the sample into Sampling Mode, or use **Select Directory** etc. to select the file and then press the Play button or the SAMPLING START/STOP switch.

**Mode (Sampling Mode) [L-Mono, R-Mono, Stereo]**

Specifies the channel(s) that you want to sample, and specifies whether a mono or stereo sample will be created.

The L and R channels of the bus specified by **Source Bus** (0–8c) will be sampled.

**L-Mono:** The left channel of the **Source Bus** will be sampled in mono.

**R-Mono:** The right channel of the **Source Bus** will be sampled in mono.

**Stereo:** The L and R channels of the bus specified by **Source Bus** will be sampled in stereo. This will create a stereo multisample and samples. For more information, see "About stereo multisamples and stereo samples" on page 681.

**Sample Time** [min sec]

This sets the amount of time that you wish to sample. This can be set in 0.001 second increments.

Immediately after the power is turned on, this parameter shows the maximum available sampling time, equivalent to the entire amount of free RAM. Each time you press STOP after sampling to RAM, the change in remaining sample time will be displayed automatically.

If **Save to** is set to **DISK**, the maximum value is determined by the free space on the current disk, as specified by the **Select Directory/File for Sample to Disk** menu command.

*Tips:* If you have sufficient RAM memory, it's a good idea to set a generous amount of **Sample Time**. After you sample, you can then use the **Truncate** menu command to delete unwanted portions of the sample, and reduce it to the minimum size necessary. For more information, see "Truncate (for Sample Edit)" on page 734 and "Truncate (for Loop Edit)" on page 740.

You can also press the SAMPLING START/STOP switch to manually stop sampling after you have recorded the desired material. For more details on sampling, see "Preparations for sampling" on page 126 of the Operation Guide.

 If **Save to** is set to **RAM**, and you continue sampling with the **Auto Optimize RAM** (Global 0-1d) option unchecked, wasted space will develop in memory, decreasing the amount of available RAM. In this case, use the **Optimize RAM** menu command to recover the wasted space.

*Note:* "Free Sample Memory/Locations" (Sampling 0-1f) in Sampling mode lets you check the remaining amount of RAM.

*Note:* The various Recording Setup settings are not made independently for each program; they apply to the entire Program mode.

**Sample to Disk** [16-bit, 24-bit]

This sets the bit depth for sampling to disk. Note that this does not affect sampling to RAM. This same parameter appears on the sampling setup pages in Program, Combination, Sequencer, and Sampling modes; changes in one place are reflected everywhere.

The resulting 24-bit files can be used at full resolution in audio tracks. You can also load them into Sampling Mode, at which time they will be automatically converted to 16-bit data.

**Bus (Output) Select** [L/R, L, R, 1...4]

This sets the audio output for the metronome sound.

**L/R:** The metronome will be heard in the main stereo outputs (L/Mono and R), the S/P DIF output, and the headphones.

**1...4:** The metronome will be heard only in the selected individual output.

**Level** [000...127]

This controls the volume of the metronome sound.

---

▼ **0-8: Page Menu Commands**

The number before each command shows its ENTER + number-key shortcut. For more information on these shortcuts, see "ENTER + 0-9: shortcuts for menu commands" on page 147.

- **0: Write Program.** For more information, see "Write Program" on page 147.
- **1: Exclusive Solo.** For more information, see "Exclusive Solo" on page 147.
- **2: Optimize RAM.** For more information, see "Optimize RAM" on page 148.
- **3: Select Sample No.** This applies only when **Save to** is set to **RAM**. For more information, see "Select Sample No." on page 149.
- **3: Select Directory.** This applies only when **Save to** is set to **Disk**. For more information, see "Select Directory" on page 149.
- **4: Auto Sampling Setup.** For more information, see "Auto Sampling Setup" on page 150.
- **5: Add to Set List.** For more information, see "Add To Set List" on page 148.

---

**0-8d: Metronome Setup**

Here you can specify the output destination and volume of the metronome, as set up in by "Metronome Precount" (0-2c). The metronome is available only if "Trigger" is set to Sampling START SW.

## 0-9: Control Surface

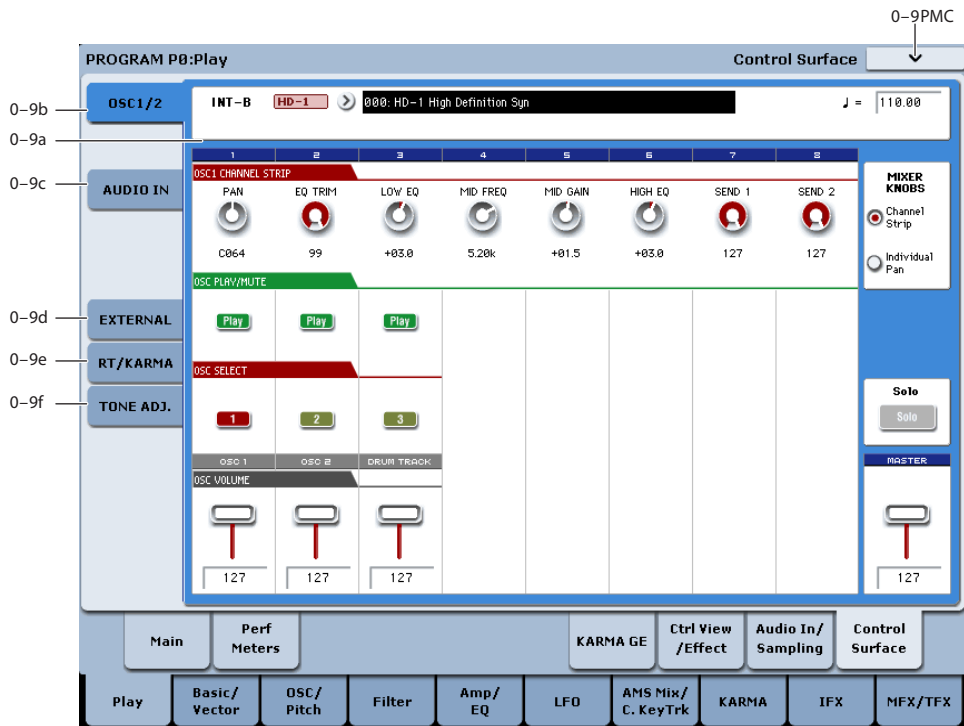

The Control Surface is the set of 9 sliders, 8 knobs, and 16 switches to the left of the LCD display. It looks like a mixer, but it can do other things as well, including editing sounds, controlling KARMA, and sending MIDI messages to external devices.

This page shows you the current values for each of the sliders, knobs, and buttons, along with information about what they are controlling. For instance, you can:

- Adjust the volume and pan for Oscillators 1 and 2
- Control the Program’s EQ settings and Master Effects Send levels
- Modulate sounds and effects using the Real Time Knobs
- Control KARMA, and select KARMA scenes, using the sliders and switches
- Edit sounds using Tone Adjust
- Assign sliders, knobs, and switches to different Tone Adjust parameters

### Local Control On/Off and the Control Surface

The Control Surface generates and receives MIDI CCs and System Exclusive messages, so that you can record knob, switch, and slider movements into a sequencer. This means that the Global mode **Local Control** setting is important:

- If **Local Control** is On, the physical Control Surface will work properly as long as MIDI is **not** being looped back into the KRONOS.
- If **Local Control** is Off, you **must** loop back MIDI into the KRONOS in order for the physical Control Surface to work properly.

- Regardless of the **Local Control** setting, you can always edit Control Surface parameters via the touch-screen.

For more information, see “Local Control and the Control Surface” on page 771.

### Control Assign Switches and Tabs

You can switch the Control Surface between its different functions using either the tabs on the left side of the LCD display, or the front-panel Control Assign switches. The tabs and the front-panel switches mirror one another; when you change one of them, the other changes as well.

In Program mode, you can select one of five different functions:

**TIMBRE/TRACK** lets you adjust the volume, pan, and send levels for Oscillators 1 and 2, along with the Program EQ. In Combi and Sequencer modes, you can also use this to select two different banks of Timbres or Tracks, as shown by the LEDs to the right of the switch.

**AUDIO INPUTS** lets you adjust the volume, pan, and send levels for the analog, USB, and S/P DIF audio inputs. In Sequencer mode, you can also use this to select two banks of hard-disk recording tracks, as shown by the LEDs to the right of the switch.

**EXTERNAL** lets you send MIDI messages to external MIDI devices. Use the Global P1- External1 page to specify the MIDI message that will be transmitted.

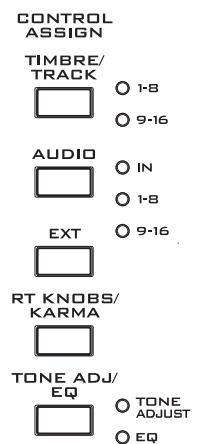

**R.TIME KNOBS/KARMA** lets you modulate sounds and effects with the knobs, and control KARMA with the sliders and switches.

**TONE ADJ./EQ** gives you hands-on access to sound editing, using the sliders, knobs, and switches.

You can freely change back and forth between the different functions, without losing any of your edits.

---

## Jump/Catch

When you change the Control Assign setting or select a new Program, Combination, or Song, the physical positions of the knobs and sliders will often be different from their parameter values.

The **Knob/Slider Mode** parameter, under System Preferences on the Global mode Basic page, determines how and when moving the physical slider or knob will start to edit the parameter value.

When it is set to **Jump**, the parameter will snap to the physical position as soon as you start to move the knob or slider. Use this if you'd like parameters to respond instantly to controller movements, and don't mind if this sometimes causes a sudden change in the audio.

When it is set to **Catch**, you need to move the slider or knob so that it "catches" the parameter, by passing through its current value. Until the value is caught, moving the slider or knob has no effect on the parameter. Once the "catch" happens, the parameter starts to change from its current value. Use this if you'd like parameter changes to be as smooth as possible, and don't mind if you have to move a controller some distance before it starts to affect the sound.

---

## RESET CONTROLS

The front-panel RESET CONTROLS button lets you recall the stored settings for any slider, knob, or switch on the control surface. You can also use it to reset the Vector Joystick to the center position, or to reset all of the parameters in the current KARMA Module, or to un-solo all channels at once.

### Resetting a single control

To reset a single knob, slider, or switch:

1. **Hold down the RESET CONTROLS button.**
2. **While holding down RESET CONTROLS, move a slider or knob, or press one of the control surface switches.**
3. **When you're done, release the RESET CONTROLS button.**

The slider, knob, or switch will be reset to the value stored in the Program or Combi. If the value is not stored (such as with the REALTIME KNOBS), the control is reset to its default value.

In Sequencer mode, controls will be reset to the state in which they were immediately after you entered Sequencer mode, selected the Song, executed Copy From Combi, etc.

### Resetting a group of controls

To reset a group of controls at once:

1. **Make sure that the Control Surface is showing the parameters you want to reset.**

As a safety precaution, you can only reset the parameters currently displayed on the Control Surface. This takes into account both the current Control Assign setting, and the MIXER KNOBS button.

For instance, if you want to reset the volume and pan for both Oscillators, make sure that Control Assign is set to TIMBRE/TRACK, and that MIXER KNOBS is set to INDIVIDUAL PAN.

2. **Hold down the RESET CONTROLS button.**
3. **While holding down RESET CONTROLS, press the current Control Assign button again.**

All of the sliders, knobs, and switches shown on the Control Surface will be reset to the values stored in the Program.

### Resetting the Vector Joystick

To reset the Vector Joystick to the center position, hold down RESET CONTROLS and then move the Vector Joystick.

### Resetting KARMA Module parameters

To reset all of the sliders and switches in the KARMA Module:

1. **Hold down the RESET CONTROLS button.**
2. **While holding down RESET CONTROLS, press the KARMA MODULE CONTROL button.**

Similarly, to reset a single KARMA Scene to its stored values, hold RESET CONTROLS and press the desired SCENE button.

### Clearing all solos

To turn off **Solo** for all MIDI Tracks, Audio Tracks, and Audio Inputs at once:

1. **Press and hold the RESET CONTROLS button.**
2. **While holding RESET CONTROLS, press the SOLO button.**

### Resetting Tone Adjust

The way that Tone Adjust is reset depends on both the current mode, and whether the parameter is Relative or Absolute. (For more information, see "Absolute, Relative, and Meta parameters" on page 30.)

In Program mode, Absolute parameters will be reset to the stored value, and Relative parameters will be reset to the center (which means no deviation from the stored value).

In Combination mode, they will be reset to the values stored in the Combination.

In Sequencer mode, they will be reset to the state in which they were immediately after you entered Sequencer mode, selected the Song, executed Copy From Combi, etc.



## 0–9a: Program Select & Tempo

**Bank** [INT–A...F, GM, g(1)...g(9), g(d),  
USER–A...G and AA...GG]

**Bank Type** [HD-1, EX*i*]

**Program** [0...127 (INT and USER Banks),  
1...128 (GM Banks)]

**♩ (Tempo)** [040.00...300.00, EXT]

This area displays information about the program selected for editing – the program bank/number/name, and the tempo used to control KARMA etc. (See “0–1a: Program Select” on page 2)

## 0–9b: OSC 1/2

This Control Assign setting lets you adjust the volume, pan, and FX send settings for Oscillators 1 and 2, along with the Program EQ settings.

**MIXER KNOBS** [Channel Strip, Individual Pan]

The Mixer Knobs switch is on the front panel, immediately to the right of the knobs, and is also duplicated in the on-screen display. The eight knobs can control two different sets of parameters, depending on the setting of this switch.



**Channel Strip:** With this setting, the eight knobs will control the Pan, EQ, and FX Send settings for the selected Oscillator. Use the SELECT buttons to choose between Oscillators 1 and 2.

**Individual Pan:** With this setting, the first knob will control the Pan for Oscillator 1, and the second knob will control the Pan for Oscillator 2. The remaining knobs are unused.

### Knobs 1–8, Channel Strip

When the Mixer Knobs switch is set to Channel Strip, the knobs provide quick access to the Pan, EQ, and FX Send parameters. The Pan and EQ parameters duplicate the similarly-named parameters found on the Program editing pages; changing them here will change them in the editing pages, and vice-versa. “FX Send” will be reflected by the corresponding MFX Send 1 and 2.

**PAN** [Random, L001...C064...R127]

This controls the stereo pan of the selected Oscillator, and mirrors the Amp page Pan parameter. A setting of L001 places the sound at the far left, C064 in the center, and R127 to the far right.

**Random** is available only via the LCD. (Otherwise, it would be difficult to use the knob to sweep smoothly from left to right.) With the **Random** setting, the pan position will be different for each note-on.

**EQ TRIM** [00...99]

This controls the volume level going into the EQ. Extreme settings of the Low, Mid, and High Gain controls can cause substantial increases in the overall level. You can compensate for this by turning down the input trim.

Note: if the EQ page EQ Bypass parameter is turned On, then none of the EQ parameters here will have any effect.

**LOW EQ** [–18.00...+18.00dB]

This controls the gain of the 80Hz Low Shelf EQ, in increments of 0.5dB.

**MID FREQ** [100Hz...10.00kHz]

This sets the center frequency for the Mid sweep EQ.

**MID GAIN** [–18.00...+18.00dB]

This controls the gain of the Mid Sweep EQ, in increments of 0.5dB.

**HIGH EQ** [–18.00...+18.00dB]

This controls the gain of the 10kHz High Shelf EQ, in increments of 0.5dB.

**SEND 1** [000...127]

This controls the send level into FX Send 1. If the Program’s **Output Bus** parameter is set to L/R or OFF, it scales the Oscillator send levels. If the **Output Bus** is set to IFX 1–12, it directly controls the post-IFX send levels.

**SEND 2** [000...127]

This controls the send level into FX Send 2. For more details, see “SEND 1,” above.

### Knobs 1–2, Individual Pan

When the Mixer Knobs switch is set to Individual Pan, knobs 1 and 2 control the pan settings for Oscillators 1 and 2, respectively. The other 6 knobs have no effect.

These duplicate the Pan parameters of the Oscillators 1 and 2 Amp pages; changing them here will change them in the editing pages, and vice-versa.

The Drum Track’s pan is controlled separately, in the Drum Kit and Drum Track Program.

**Pan (1)** [Random, L001...C064...R127]

This controls the stereo pan of Oscillator 1. A setting of L001 places the sound at the far left, C064 in the center, and R127 to the far right.

**Random** is available only via the LCD. (Otherwise, it would be difficult to use the knob to sweep smoothly from left to right.) With the **Random** setting, the pan position will be different for each note-on.

**Pan (2)** [Random, L001...C064...R127]

This controls the stereo pan of Oscillator 2. For more details, see “Pan (1),” above.

### Play/Mute switches 1–3

The top row of switches allow you to turn Oscillator 1, Oscillator 2, and the Drum Track Program on and off, which can be convenient when editing sounds.

**Play/Mute (1)** [Play, Mute]

When this switch is on (LED = on), Oscillator 1 will play. When the switch is off (LED = off), Oscillator 1 will be muted.

**Play/Mute (2) [Play, Mute]**

When this switch is on, Oscillator 2 will play. When the switch is off, Oscillator 2 will be muted.

**Play/Mute (3) [Play, Mute]**

When this switch is on, the Drum Track Program will play. When the switch is off, the Drum Track Program will be muted.

**SOLO switch and SELECT switches 1–3**

**Solo [Off, On]**

**Solo** lets you isolate one or more Oscillators or Audio Inputs, so that you hear them by themselves. It does this by temporarily muting all non-soloed Oscillators and Audio Inputs.

**Solo** uses the SELECT switches. These switches can show and control either which Oscillator is currently selected, or which Oscillators or inputs are soloed. The main **Solo** button lets you switch back and forth between the two views.

When **Solo** is **Off** (LED = Off), the SELECT switches select the current Oscillator; when **Solo** is **On** (LED = On or blinking), the Select switches let you solo one or both Oscillators, and/or Audio Inputs.

When **Solo** is **On**, and one or more Oscillators or Audio Inputs are soloed, the SOLO LED will blink on and off to remind you that solo is in use.

*Note:* The main SOLO button merely changes the functions of the SELECT/SOLO switches. It does not enable or clear the individual solo states.

**Clearing all solos**

To turn off **Solo** for all Oscillators and Audio Inputs at once:

1. Press and hold the **RESET CONTROLS** button.
2. While holding **RESET CONTROLS**, press the **SOLO** button.

**Exclusive Solo menu parameter**

The menu's **Exclusive Solo** parameter also affects the way that Solo works. When **Exclusive Solo** is **Off** (unchecked), you can solo multiple oscillators and inputs at once.

When **Exclusive Solo** is **On** (checked), only one oscillator or input can be soloed at a time. In this mode, pressing a Solo switch automatically disables any previous solos.

You can also toggle **Exclusive Solo** by holding **ENTER** and pressing **1** on the numeric keypad.

**OSC1 Select/Solo [Off, On]**

This switch either selects or solos Oscillator 1, depending on the Solo switch. For more details, see "Solo," above.

**OSC2 Select/Solo [Off, On]**

This switch either selects or solos Oscillator 2, depending on the Solo switch. For more details, see "Solo," above.

**Drum Track Select/Solo [Off, On]**

This switch either selects or solos the Drum Track Program, depending on the Solo switch. For more details, see "Solo," above.

**MIX VOLUMES Sliders 1–3**

These sliders adjust the overall output level of Oscillators 1 and 2. These are separate volume controls, which scale the main Amp level parameter.

**OSC 1 Volume [000...127]**

This slider adjusts the volume level of Oscillator 1.

**OSC 2 Volume [000...127]**

This slider adjusts the volume level of Oscillator 2.

**Drum Track Volume [000...127]**

This slider adjusts the volume level of the Drum Track Program.

**Master Volume Slider**

**Master Volume [000...127]**

This controls the volume of the main stereo outputs, after the Total Effects. It does not affect Individual Outputs 1–4.

*Master Volume*

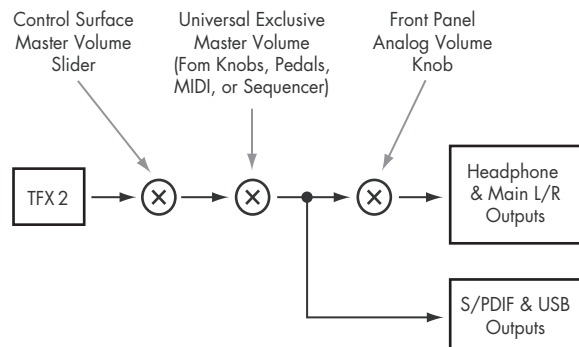



Control Surface - Audio In

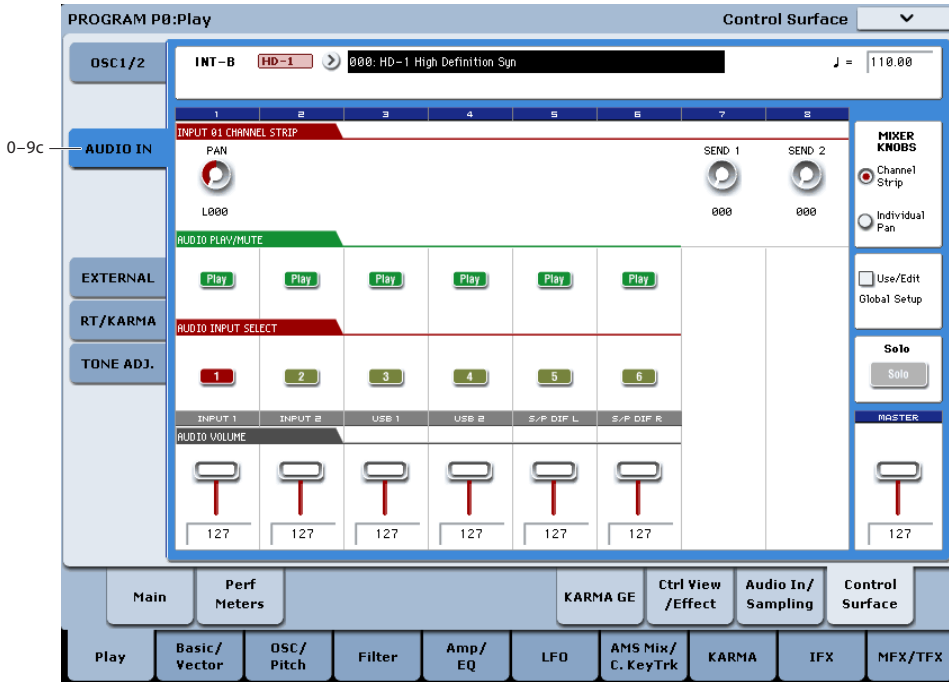

**0-9c: Audio Inputs**

This Control Assign setting lets you adjust the volume, pan, and FX send settings for each of the six audio inputs: Analog 1/2, USB 1/2, and S/P DIF left & right.

You can use this page to mix sounds from other sources into the KRONOS outputs - as an on-stage submixer, for instance.

**Other Audio Input settings**

Each audio input can be assigned to up to three busses:

- An Output/IFX Bus
- An FX Control Bus
- A REC Bus

You can set up these bus assignments on the Audio In/Sampling page. For more information, see “0-8: Audio Input/Sampling” on page 14.

**Use/Edit Global Setup [Off, On]**

Programs can use the single, Global audio input mixer setup, or can instead have their own custom settings.

When **Use/Edit Global Setup** is **On**, the Program uses the Global settings. This is the default, and lets you change freely between different Programs and Combinations without affecting the audio inputs.

Also, any edits made on this page will affect the Global setting, along with any other Programs, Combs, or Songs which use the Global setting.

On the other hand, it may sometimes be convenient to save a particular mixer setup with an individual Program, to set up special sub-mixer settings or effects processing for particular inputs. In this case, set **Use/Edit Global Setup** to **Off**, and the audio inputs will use the Program’s custom settings.

**Mixer Knobs [Channel Strip, Individual Pan]**

This switch controls whether the knobs show the pan settings for all 6 inputs at once (Individual Pan), or the pan and FX Send levels for the selected input (Channel Strip). For more information, please see “Mixer Knobs” on page 25.

**Knobs 1-8, Channel Strip**

When the Mixer Knobs switch is set to Channel Strip, the knobs provide quick access to the selected input’s Pan and FX Send parameters.

**Pan [L000...C064...R127]**

This controls the stereo pan of the selected input. A setting of **L000** places the sound at the far left, **C064** in the center, and **R127** to the far right.

**Send 1 [000...127]**

This controls the send level into FX Send 1. If the input’s **Output Bus** parameter is set to L/R or OFF, it scales the programmed send level. If the **Output Bus** is set to IFX 1-12, it directly controls the post-IFX send levels, overwriting any previous setting.

**Send 2 [000...127]**

This controls the send level into FX Send 2. For more details, see “Send 1,” above.

**Knobs 1-6, Individual Pan**

When the Mixer Knobs switch is set to Individual Pan, knobs 1-6 control pan for each of the audio inputs. Knobs 7 and 8 have no effect.

**Audio Input Pan (1-6) [L000...C064...R127]**

Knobs 1 and 2 control the pan settings for analog inputs 1 & 2, knobs 3 and 4 control the pan for USB inputs 1 & 2, and knobs 5-6 control the pan for the left

and right S/P DIF inputs. A setting of **L000** places the sound at the far left, **C064** in the center, and **R127** to the far right.

### **Play/Mute switches 1–6**

The top row of switches allow you to mute any or all of the audio inputs.

#### **Play/Mute (1–6) [Off, On]**

When this switch is on (LED = on), the input will be enabled. When the switch is off (LED = off), the input will be muted.

### **SOLO switch and SELECT switches 1–6**

#### **Solo [Off, On]**

Solo lets you isolate one or more Oscillators or audio inputs, so that you hear them by themselves. It does this by temporarily muting all non-soloed Oscillators and audio inputs.

The Select switches can show and control either which audio input is currently selected, or which inputs are soloed. The main Solo button lets you can switch back and forth between the two views.

When Solo is **Off** (LED = Off), the Select switches select the current input; when Solo is **On** (LED = On or blinking), the Select switches let you solo one or more inputs.

When Solo is **On**, and one or more Oscillators or audio inputs are soloed, the Solo LED will blink on and off to remind you that solo is in use.

*Note:* The main Solo button merely changes the functions of the Select/Solo switches. It does not enable or clear the individual solo states.

For more information, see “Clearing all solos” on page 24, and “Exclusive Solo menu parameter” on page 24.

#### **Select/Solo (1–6) [Off, On]**

This switch either selects or solos the input, depending on the Solo switch setting. For more details, see “Solo,” above.

### **Sliders 1–6**

#### **Audio Input Volume (1–6) [000...127]**

These sliders adjust the volume levels of the audio inputs.

### **Master Volume Slider**

#### **Master Volume [000...127]**

This controls the volume of the main stereo outputs, after the Total Effects. It does not affect Individual Outputs 1–4. For more information, see the diagram “Master Volume” on page 24.

Control Surface - External

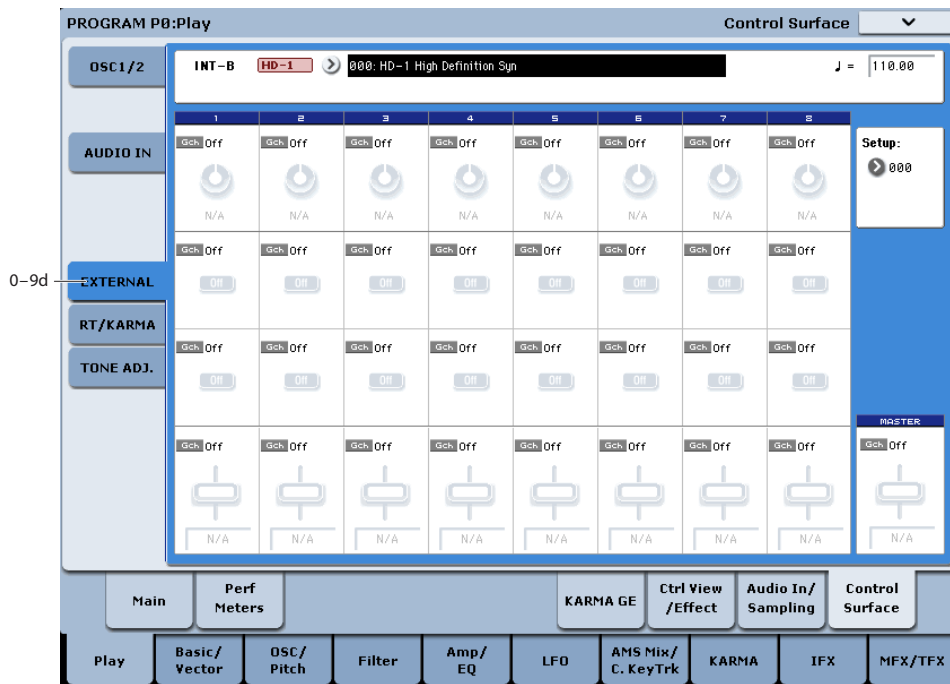

**0-9d: External**

This Control Assign setting lets you send MIDI messages to external devices. Each slider, knob, and switch can be assigned to a separate MIDI controller and MIDI channel. The eight pads also have separate assignments which apply only when Control Assign is set to External.

For instance, you might make one setup for controlling several different pieces of MIDI gear on stage, another for controlling a software synthesizer (such as one of Korg’s Legacy Collection synths), and so on.

These assignments are determined by the selected External Setup. The KRONOS has 128 External Setups, which can be edited in Global mode (see “1-2: External 1” on page 777).

When you select an External Setup, it stays selected even when you change Programs or switch to another mode. This makes it easy to select different KRONOS sounds without disrupting external MIDI control, and vice-versa.

You can think of External mode as being a separate control surface which just happens to share KRONOS’s sliders, knobs, switches, and pads.

**Setup** [000...127]

This selects the External Setup for the knobs, sliders, switches, and pads.

**Note:** this selection is persistent for the entire KRONOS; is not stored with the Program.

**Knobs 1-8**

**MIDI Channel (1-8)** [01...16, Gch]

This read-only parameter shows the MIDI Channel assigned to the knob. Each can send on a different channel, if desired.

**Gch** means that the knob will transmit on the Global MIDI Channel, as set in Global mode. This allows you to re-direct any number of sliders, knobs, switches, and on-screen pads to a different channel at once, without editing the individual controls.

**CC# Assign (1-8)** [Off, 000...119]

This read-only parameter shows the MIDI CC sent by the knob.

**Note:** to change the mapping of CCs to controls, edit the External Setups in Global P1-2: External 1. For more information, see “1-2: External 1” on page 777.

**Value (1-8)** [000...127]

This is the current value of the knob’s MIDI CC.

**Switches 1-16**

**MIDI Channel (1-16)** [01...16, Gch]

This read-only parameter shows the MIDI Channel for the switch. Each can send on a different channel, if desired.

**Gch** means that the slider will transmit on the Global MIDI Channel, as set in Global mode.

**CC# Assign (1-16)** [Off, 000...119]

This read-only parameter shows the MIDI CC sent by the switch.

**Switch Off/On (1-16)** [Off, On]

When the switch is turned on, it sends a value of 127; when it is turned off, it sends a value of 0.

**Sliders 1-8 & Master Slider**

**MIDI Channel (1-8)** [01...16, Gch]

This read-only parameter shows the MIDI Channel for the slider. Each can send on a different channel, if desired.

Gch means that the slider will transmit on the Global MIDI Channel, as set in Global mode.

**Value (1-8)** [000...127]

This is the current value of the slider's MIDI CC.

**CC# Assign (1-8)** [Off, 000...119]

This read-only parameter shows the MIDI CC sent by the slider.

Control Surface - RT/KARMA

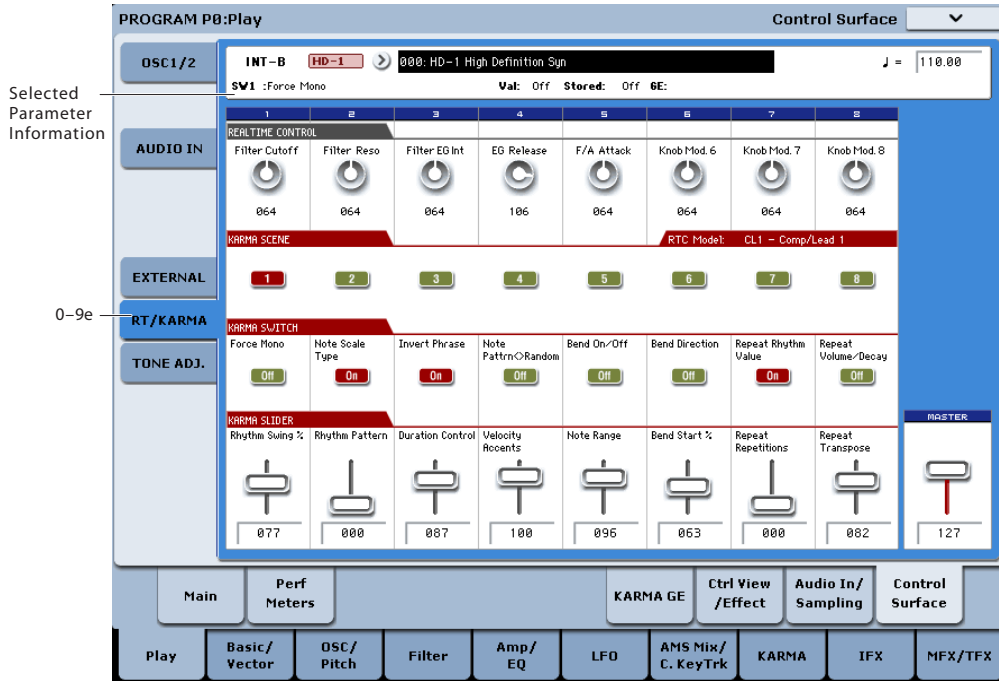

**0-9e: RT/KARMA (Real Time Knobs/KARMA)** AMSOURCE

This Control Assign (labeled **R. Time Knobs/KARMA** on the front panel) setting lets you modulate Program and Effects parameters with the eight knobs, and control KARMA with the switches and sliders.

**Selected parameter information**

When you select a KARMA Slider or Switch, this area shows detailed information about its KARMA parameter assignments.

**Control** [SW1...8, SL1...8]

This shows which Switch or Slider is currently selected.

**Assignment** [Name]

Each KARMA Slider or Switch can control multiple internal parameters simultaneously. The group of parameters can be given a single name, which is shown here.

You can select different names, if desired. For more information, see "7-9: Name/Note Map" on page 132

**Module and Parameter** [A 01...32, P 01...08]

This read-only display shows the KARMA parameter(s) assigned to the Slider or Switch.

**A** means that the slider or switch controls a GE Real-Time Parameter from KARMA Module A. (Note that in Program mode, only Module A is available.) The

following number identifies the specific parameter within the module. For instance, **A22** is parameter 22 of Module A.

**P** means that the switch is controlling a Performance Real-Time Parameter.

You can assign many parameters to a single slider or switch, if desired. Due to space limitations, however, only the first five parameters will be shown here.

To change the parameter assignments, use the KARMA GE RTP and Perf RTP pages. For more information, please see "7-5: GE Real-Time Parameters/Scenes" on page 120, and "7-6: Perf Real-Time Parameters" on page 123.

**Parameter Value** [Depends on parameter]

This shows the value of the GE or Performance Real-Time Parameters assigned to the selected Slider or Switch. The range can vary, depending on the individual parameters.

**Knobs 1-8**

Knobs 1-4 all have dedicated functions which correspond to MIDI CCs. Knobs 5-8 can be assigned to a wide variety of functions, many of which also have corresponding MIDI CCs.

When you move a knob, it sends out the corresponding MIDI CC. Also, when the CC is received via MIDI or generated by KARMA, the knob value changes to match the CC value.

Unless otherwise noted, “scaling” means that the parameters are at their programmed values when the controller is at 64, at their minimum when the controller is at 0, and at their maximum when the controller is at 127. For another look at this, see the diagram below.

*CC parameter scaling*

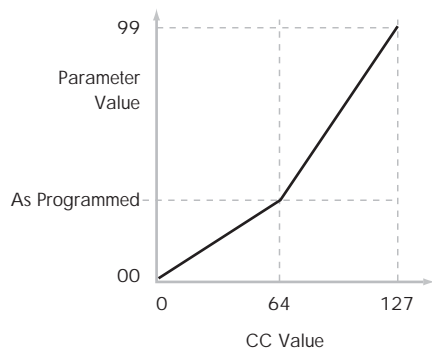

**Knob 1: CUTOFF (CC#74) [000...127]**

This knob scales the cutoff frequencies of Filters A and B, and transmits and receives MIDI CC #74.

**Knob 2: RESONANCE (CC#71) [000...127]**

This knob scales the resonance of Filters A and B, and transmits and receives MIDI CC #71.

**Knob 3: Filter EG Intensity (CC#79) [000...127]**

This knob scales the effect of the Filter EG on the cutoff frequencies of Filters A and B. It also transmits and receives MIDI CC#79.

**Knob 4: EG Release (CC#72) [000...127]**

This knob scales the release time of the Filter and Amp EGs, and transmits and receives MIDI CC#72.

**Knob 5–8 [000...127]**

This is the current value of the knob and its MIDI CC.

You can set knobs 5–8 to a wide variety of modulation functions, using the Controller Setup page (P1–8).

Many of the functions scale a particular set of Program parameters. All of the settings also correspond to MIDI messages—usually CCs.

Note that, as with AMS modulation in general, on-screen knobs and graphic parameter displays (such as filter graphics, envelope graphics, etc.) do not change to reflect modulation from CCs.

**KARMA SCENES 1–8**

A KARMA Scene includes the settings for all of the KARMA Sliders and Switches. Each Combi can contain up to eight Scenes.

To select a Scene, just press its switch - you’ll see all of the KARMA Sliders and Switches update instantly to their new values.

**KARMA SWITCHES 1–8**

These switches control KARMA Performance or GE (Generated Effect) parameters, as assigned on the KARMA Perf RTP and GE RTP pages.

**KARMA SLIDERS 1–8**

These sliders control KARMA Performance or GE (Generated Effect) parameters, as assigned on the KARMA Perf RTP and GE RTP pages.

For more information, see “KARMA SWITCHES 1–8,” above.

**Master Volume Slider**

**Master Volume [000...127]**

This controls the volume of the main stereo outputs, after the Total Effects. It does not affect Individual Outputs 1–4. For more information, see the diagram “Master Volume” on page 24.

Control Surface - Tone Adjust

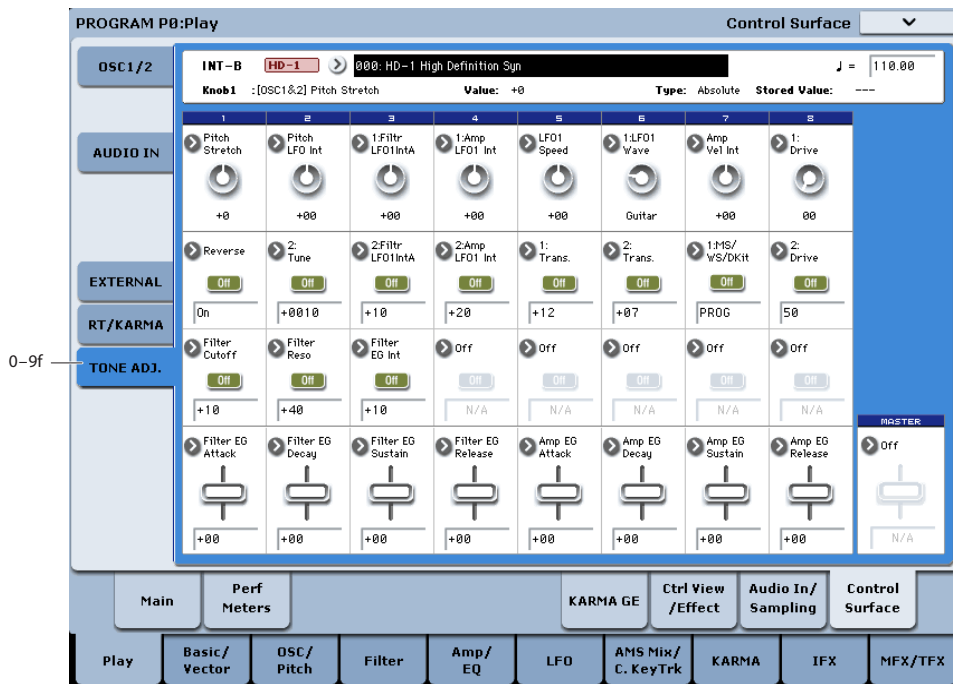

**0-9f: Tone Adjust**

Tone Adjust lets you use all of the sliders, knobs, and switches on the Control Surface to edit Program parameters, like the knobs on an analog synth. Each physical control can be assigned to any one of a number of Program parameters.

*Tip:* In Combi and Sequencer modes, Tone Adjust also lets you edit Program parameters without needing to save a different version of the original Program. For more information on Tone Adjust in these modes, see “0-9f: Tone Adjust” on page 436.

**Saving Tone Adjust Edits**

Tone Adjust edits are saved in two different ways, depending on whether the parameter is **Relative** or **Absolute**. (For more information, see “Absolute, Relative, and Meta parameters,” below.)

Edits to **Relative** parameters affect the sound immediately, but don’t change the underlying Program parameter settings until the Program is saved. When the Program is saved, the KRONOS calculates the combined effects of Tone Adjust and dedicated CC modulation (from the Real Time Knobs, for instance), and saves the results into the Program parameters directly. At that point, all of the Relative parameters are reset to 0.

Edits to **Absolute** parameters are immediately reflected in the corresponding on-screen parameters, and vice-versa.

**Tone Adjust and MIDI SysEx**

The Tone Adjust sliders, knobs, and switches all send and receive MIDI System Exclusive messages. You can use this to record and play back Tone Adjust edits with a sequencer, including the built-in sequencer.

**NOTE:** The SysEx messages are tied to the physical controls, and not to the functions to which they are assigned. For instance, let’s say that slider 1 is assigned to control Filter Resonance, and move slider 1 while recording into a sequencer. The sequencer will record that slider 1 has moved, and not that Filter Resonance has changed. If you later change slider 1 to control LFO1 Speed, playing back the sequence will affect the LFO, and not Filter Resonance.

**Interaction between Tone Adjust and MIDI CCs**

A number of the Common Tone Adjust parameters affect parameters which are also modulated by dedicated MIDI CCs. The specific CC numbers are noted in the descriptions for the individual Tone Adjust parameters, below.

Tone Adjust and the CCs work separately. It’s possible, for instance, for Tone Adjust to reduce the value of a parameter, and then for a CC to increase it again.

Tone Adjust scales the parameter first, and then the CC scales the result of the Tone Adjust.

**Absolute, Relative, and Meta parameters**

There are three kinds of Tone Adjust parameters: Absolute, Relative, and Meta.

**Absolute** parameters usually control a single Program parameter, such as **Oscillator 1 Transpose**. The Program and Tone Adjust parameters mirror one another; when you change one, the other will change to match.

**Relative** parameters typically adjust two or more Program parameters simultaneously. For instance, **Filter/Amp EG Attack Time** affects a total of six Program parameters. The value of the Relative parameter shows the amount of change to these underlying Program parameters.



When the Relative parameter is at 0 (in the center of the knob or slider), the underlying Program parameters are unchanged.

The meanings of higher and lower settings can vary, depending on the specific parameter. Unless noted otherwise, they work as follows:

When the Relative parameter is at +99 (the maximum), the Program parameters are all at their maximum as well. Similarly, when the Relative parameter is at -99 (the minimum), the Program parameters are at zero.

Relative Tone Adjust parameter scaling

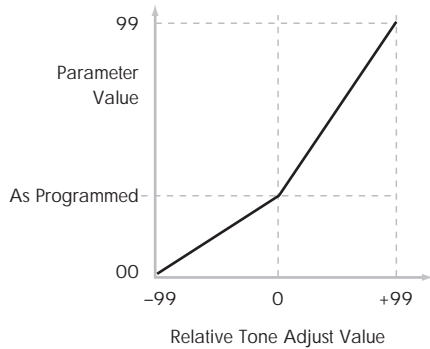

A few of the Program parameters controlled by Relative Tone Adjust are bipolar, meaning that they can be either positive or negative (instead of just positive). When these Program parameters are set to negative values, Tone Adjust may behave differently from the description above.

For instance, if EG Intensity is set to a negative value, Relative Tone Adjust will take it from 0 to -99, like the inverse of the diagram above. EG Sustain works differently; if it's set to a negative value, Tone Adjust takes it from 0 down to the programmed value, and then up to +99, as shown below.

Relative Tone Adjust parameter scaling: EG Sustain

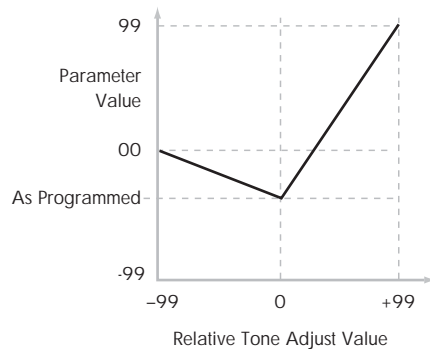

**Meta** parameters don't affect Program parameters directly. Instead, they affect the way that other Tone Adjust parameters work. For instance, **Multisample Min #** and **Max #** set the minimum and maximum values of the Tone Adjust **Multisample** parameter.

**Selected parameter information**

This status line shows detailed, read-only information about the currently selected Tone Adjust parameter.

**(Control)** [Knob1...8, SW1...16, Slider1...8, Slider M]

This is the physical controller assigned to the Tone Adjust parameter. **Slider M** is the Master Slider.

**(Assignment)** [Full Parameter Name]

This shows the full name of the parameter assigned to the controller. You can change this using the "Assign" parameter, below.

**Value** [Current Parameter Value]

This shows the current value of the parameter. The range of values will vary depending on the parameter assigned to the control.

**Type** [Relative, Absolute, Meta]

This shows the type of the parameter, which relates to how edits to the parameter are saved. For more information, see "Absolute, Relative, and Meta parameters" on page 30.

**Stored Value** [Original Parameter Value]

This shows the original value of the parameter, before the effects of Tone Adjust. It applies only to Tone Adjust parameters which control a single Program parameter.

If you un-assign a **Relative** parameter from a control, it will revert to this value.

**Knobs 1-8**

**Assign** [List of Tone Adjust assignments]

This lets you assign a Tone Adjust parameter to the knob. For a full list of the available choices, please see "Common Tone Adjust Parameters" and "HD-1 Tone Adjust Parameters," below.

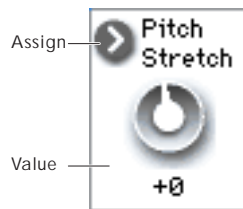

Per-Oscillator parameters apply to OSC1 and 2 individually, and are marked as such: [OSC1] and [OSC2].

Each controller can be assigned to only one parameter, and each parameter can be assigned to only one controller.

To swap a parameter from one control to another, you'll need to first un-assign it from the old control, and then assign it to the new control.

**Value** [Depends on parameter]

This shows the current value of the parameter. The range of values will vary depending on the parameter assigned to the control.

### Switches 1–16

Tone Adjust switches act a little differently than knobs and sliders.

When a switch is assigned to a **Relative** parameter, or an **Absolute** parameter with more than two states:

Switch On = **On Value** (see below)

Switch Off = the Program's stored value

When a switch is assigned to a two-state **Absolute** parameter, such as **Hold**, the switch status directly reflects the parameter value:

Switch On = **On**

Switch Off = **Off**

#### Assign [List of Tone Adjust assignments]

This lets you assign a Tone Adjust parameter to the switch. For a full list of the available choices, please see "Common Tone Adjust Parameters" and "HD-1 Tone Adjust Parameters," below.

#### On Value [Depends on parameter]

The parameter is set to this value when the switch is On.

When the switch is assigned to a two-state **Absolute** parameter, such as **Hold**, this will always be the same as the **Switch Status** (see below).

#### Switch Status [Off, On]

This simply shows whether the switch is On or Off. The status is also shown by the LEDs in the physical buttons.

### Sliders 1–8 and Master Slider

These work identically to Knobs 1–8, as described above.

---

## Common Tone Adjust Parameters

These parameters affect both Oscillators 1 and 2.

Unless otherwise noted, all of the Common Tone Adjust parameters are **Relative**.

**Off.** This means that the Tone Adjust control has no effect.

#### Filter Cutoff. (–99...+99, CC#74)

This scales the cutoff frequency of all of the filters at once. For instance, in the HD-1, it affects both Filters A and B.

#### Filter Resonance. (–99...+99, CC#71)

This scales the resonance of all of the filters at once. For instance, in the HD-1, it affects both Filters A and B.

#### Filter EG Intensity. (–99...+99, CC#79)

This scales the effect of the Filter EG on the cutoff frequency. It affects all of the filters at once; for instance, in the HD-1, it affects both Filters A and B.

–99 means no modulation. +99 means maximum modulation in the same direction, positive or negative, as the original Program. For instance, if the original Program's EG Intensity was set to –25, then setting the Tone Adjust to +99 moves the EG Intensity to –99.

#### Amp Velocity Intensity. (–99...+99)

This scales the effect of velocity on the Amp level.

–99 removes the velocity modulation entirely. +99 means maximum modulation in the same direction, positive or negative, as the original Program.

#### Filter/Amp EG Attack Time.

(–99...+99, CC#73)

This scales the attack times of the Filter and Amp EGs, along with other related parameters.

When the value is +1 or more, this also affects the Amp EG's Start and Attack Levels, Start Level AMS, and Attack Time AMS, as described below:

Between values of +1 and +25, the Start Level, Start Level AMS, and Attack Time AMS will change from their programmed values to 0. Over the same range, the Attack Level will change from its programmed value to 99.

#### Filter/Amp EG Decay Time.

(–99...+99, CC#75)

This scales the decay and slope times of the Filter and Amp EGs. It interacts with CC# 75.

#### Filter/Amp EG Sustain Level.

(–99...+99, CC#70)

This scales the sustain levels of the Filter and Amp EGs.

#### Filter/Amp EG Release Time.

(–99...+99, CC#72)

This scales the release times of the Filter and Amp EGs.

#### Filter EG Attack Time. (–99...+99)

This scales the attack times of the Filter EGs.

#### Filter EG Decay Time. (–99...+99)

This scales the decay and slope times of the Filter EGs.

#### Filter EG Sustain Level. (–99...+99)

This scales the sustain levels of the Filter EGs.

#### Filter EG Release Time. (–99...+99)

This scales the release times of the Filter EGs.

#### Amp EG Attack Time. (–99...+99)

This scales the attack times of the Amp EGs.

#### Amp EG Decay Time. (–99...+99)

This scales the decay and slope times of the Amp EGs.

#### Amp EG Sustain Level. (–99...+99)

This scales the sustain levels of the Amp EGs.

#### Amp EG Release Time. (–99...+99)

This scales the release times of the Amp EGs.

#### Pitch EG Attack Time. (–99...+99)

This scales the attack times of the Pitch EG (or EGs, in the case of some EXi instruments).

#### Pitch EG Decay Time. (–99...+99)

This scales the decay and slope times of the Pitch EG (or EGs, in the case of some EXi instruments).

#### Pitch EG Sustain Level. (–99...+99)

This scales the sustain levels of the Pitch EG (or EGs, in the case of some EXi instruments). **Note:** this does not apply to the HD-1.

#### Pitch EG Release Time. (–99...+99)

This scales the release times of the Pitch EG (or EGs, in the case of some EXi instruments).

#### Pitch LFO1 Intensity. (–99...+99, CC#77)

This scales the effect of LFO1 on the Pitch.



-99 removes the LFO modulation entirely. +99 means maximum modulation in the same direction, positive or negative, as the original Program.

**LFO1 Speed. (-99...+99, CC#76)**

This scales LFO1's frequency. When the LFO is in MIDI/Tempo mode, this adjusts the Base Note. For more information, please see "Frequency" on page 93.

**LFO1 Fade. (-99...+99)**

This scales LFO1's fade-in time. For more information, please see "Fade" on page 94.

**LFO1 Delay. (-99...+99, CC#78)**

This scales LFO1's delay time - the time between note-on and the onset of the LFO. For more information, please see "Delay" on page 94.

This parameter interacts with CC# 78.

**LFO1 Stop. (PROG/Off/On, Absolute)**

This **Absolute** parameter controls whether LFO1 is stopped or running. For more information, please see "Stop" on page 93.

The **PROG** setting restores the Program's original values—convenient if Oscillator 1's LFO was stopped, but Oscillator 2's was not.

**LFO2 Speed. (-99...+99)**

This scales LFO2's frequency. When the LFO is in MIDI/Tempo mode, this adjusts the Base Note. For more information, please see "Frequency" on page 93.

**LFO2 Fade. (-99...+99)**

This scales LFO2's fade-in time. For more information, please see "Fade" on page 94.

**LFO2 Delay. (-99...+99)**

This scales LFO2's delay time - the time between note-on and the onset of the LFO. For more information, please see "Delay" on page 94.

**LFO2 Stop. (PROG/Off/On, Absolute)**

This **Absolute** parameter controls whether LFO2 is stopped or running. For more information, please see "Stop" on page 93.

**Common LFO Speed. (-99...+99)**

This scales the Common LFO's frequency. When the LFO is in MIDI/Tempo mode, this adjusts the Base Note.

**Unison. (Off/On, Absolute)**

This **Absolute** parameter turns **Unison** on and off. For more information, please see "Unison" on page 38.

**Number Of Voices. (2...16, Absolute)**

This **Absolute** parameter sets the number of Unison voices. If **Unison** is not **On**, this parameter has no effect. For more information, please see "Number of voices" on page 38.

**Detune. (0.0...200.0, Absolute)**

This **Absolute** parameter sets amount of detuning between the Unison voices. If **Unison** is not **On**, this parameter has no effect. For more information, please see "Detune" on page 38.

**Thickness. (Off/01...09, Absolute)**

This **Absolute** parameter sets the pattern of detuning between the Unison voices. If **Unison** is not **On**, or if **Detune** is set to 0, this parameter has no effect. For more information, please see "Thickness" on page 39.

**Common Step Sequencer Attack Smoothing. (00...99, Absolute)**

This **Absolute** parameter sets amount of attack smoothing for the Common Step Sequencer. Note that this applies only to EXi Programs. For more information, please see "Smoothing" on page 178.

**Common Step Sequencer Decay Smoothing. (00...99, Absolute)**

This **Absolute** parameter sets amount of decay smoothing for the Common Step Sequencer. Note that this applies only to EXi Programs. For more information, please see "Smoothing" on page 178.

**HD-1 Tone Adjust Parameters**

**Macro parameters**

The following three parameters affect both Oscillator 1 and Oscillator 2.

\* In the list below, the items in parentheses are (value range, edit type) respectively.

**Pitch Stretch. (-12...+12, Relative)**

This special control increases the Oscillator **Tune** parameter while lowering the **Transpose** parameter. The result is that the pitch stays the same, but the mapping of the samples to the keys changes. You can use this to create interesting shifts in timbre.

**Hold. (Off/On, Absolute)**

This lets you turn Hold on and off. For more information on this parameter, see "Hold" on page 39.

**Reverse. (PROG/Off/On, Absolute)**

This provides a quick way to turn Reverse on or off for all Multisamples in both Oscillators. **PROG** restores the Program's original settings—convenient if some Multisamples had been set to Off, and others set to On.

**Per-Oscillator parameters**

These parameters affect each Oscillator separately. In the list, the parameters for Oscillator 1 appear first, with each name prefaced by [OSC1]; the parameters for Oscillator 2 appear next, prefaced by [OSC2].

\* In the list below, the items in parentheses are (value range, edit type) respectively.

**Tune. (-1200...+1200, Relative)**

This **Relative** parameter adds to or subtracts from the Oscillator's Tune setting, as described under "Tune" on page 57.

**NOTE:** as with **Transpose**, below, this is a simple addition or subtraction, as opposed to the more complex "scaling" function.

**Transpose. (-60...+60, Relative)**

This **Relative** parameter adds to or subtracts from the Oscillator's Transpose setting, as described under "Transpose" on page 57.

**MS/WS/DKit Select. (PROG/0...16383, Absolute)**

This lets you select a new Multisample or Wave Sequence for the Oscillator (in Single or Double Programs), or a different Drum Kit (in Drum Programs). You can either use this to select different sounds via a knob or slider—for instance, to select one out of a set of synth wavetables—or to override Program settings in a Combination or Song.

**PROG** restores the Program's original Multisamples, Wave Sequences, or Drum Kits, including all velocity ranges and **Reverse** and **Start Offset** settings.

The list of Multisamples, Wave Sequences, or Drum Kits can be quite long. The sliders or knobs will let you sweep through the entire range, but it may not be possible to select all of the intermediate values. You can always select a specific value by editing the on-screen parameter via the standard data entry controls, such as the INC and DEC buttons.

You can also limit the range of the control by using the **Min #** and **Max #** parameters, described below.

For Single and Double Programs:

- **MS/WS/DKit Select** overrides all of the Multisample Velocity zones, so that the newly selected Multisample or Wave Sequence plays over the entire velocity range.
- By default, if the original Program's MS1 is a Multisample, you can select Multisamples; if MS1 is a Wave Sequence, you can select Wave Sequences. You can use the **MS/WS Type** parameter, described below, to change between Multisamples and Wave Sequences as desired.

For Multisamples only:

- By default, you can select from the same Bank as the original Program's MS1. To select a different Bank, use the **MS Bank** parameter described below. (Note that **MS Bank** cannot be used to change to User Sample Banks or EXs numbered 126 and higher.)
- You can use the Tone Adjust **Reverse** and **Start Offset** parameters to modify the newly selected Multisample. By default, **Reverse** is set to **Off**, and **Start Offset** is set to **0**.

For Wave Sequences and Drum Kits:

- Wave Sequence and Drum Kit Banks are ignored; all items in all banks are available in a continuous list via the **Select** parameter.

#### **MS/WS Type. (Off/MS/WavSeq, Meta)**

This Meta-parameter modifies the **MS/WS Select** parameter, so that you can specifically choose to select either Multisamples or Wave Sequences.

If the **Select** parameter is not used, or if the current sound is a Drum Program, **MS/WS Type** has no effect.

#### **MS Bank. (ROM mono/stereo, Smp:Old RAM mono/stereo, EXs1 mono...EXs125 stereo, Meta)**

This Meta-parameter modifies the **MS/WS/Dkit Select** parameter, so that you can choose Multisamples from a Bank other than the one selected in the Program. You cannot use **MS Bank** to change to User Sample Banks or EXs numbered 126 and higher.

If the **Select** parameter is not used, this setting has no effect. **MS Bank** does not apply to Wave Sequences and Drum Kits, as described above.

#### **MS/WS/DKit Min #. (0...16383, Meta)**

This Meta-parameter sets a minimum value for the **MS/WS/Dkit Select** parameter. You can use this in conjunction with the **MS/WS/DKit Max #** parameter, below, so that a knob or slider selects only from a small set of choices. This is particularly convenient with the internal ROM, in which similar Multisamples are

grouped together. For instance, this makes it easy to select between a group of bells, or a set of electric basses.

If the **Select** parameter is not used, this setting has no effect.

#### **MS/WS/DKit Max #. (0...16383, Meta)**

This Meta-parameter sets a maximum value for the **MS/WS/Dkit Select** parameter. Please see **MS/WS/DKit Min #**, above, for more information.

#### **Start Offset. (0...8, Absolute)**

This allows you to change the Start Offset of the Multisample specified by the **MS/WS Select** parameter. It applies only when:

- The Program is a Single or Double (not a Drum Kit)
- The **MS/WS Select** parameter is used to select a Multisample (not a Wave Sequence)

For more information on Start Offsets, see "Start Offset" on page 60.

#### **Drive. (0...99, Absolute)**

This controls the Oscillator's **Drive** parameter, as described under "Drive" on page 82.

#### **Low Boost. (0...99, Absolute)**

This controls the Oscillator's **Low Boost** parameter, as described under "Low Boost" on page 83.

#### **Pitch Slope. (-1.0...2.0, Absolute)**

This controls the Oscillator's **Pitch Slope** parameter, as described under "Pitch Slope" on page 63.

#### **LFO 1 Waveform. (Triangle...Rad6, Absolute)**

This selects the waveform for the Oscillator's **LFO 1**, as described under "Waveform" on page 92.

#### **LFO 2 Waveform. (Triangle...Rad6, Absolute)**

This selects the waveform for the Oscillator's **LFO 2**, as described under "Waveform" on page 92.

#### **Amp LFO 1 Intensity. (-99...+99, Absolute)**

This controls the depth and direction of Amp modulation from LFO1, as described under "4-2c: LFO 1/2" on page 86.

#### **Amp LFO 2 Intensity. (-99...+99, Absolute)**

This controls the depth and direction of Amp modulation from LFO2, as described under "4-2c: LFO 1/2" on page 86.

#### **Filter LFO 1 Intensity to A. (-99...+99, Absolute)**

This controls the depth and direction of Filter A cutoff modulation from LFO1, as described under "3-3a: LFO 1/2" on page 76.

#### **Filter LFO 1 Intensity to B. (-99...+99, Absolute)**

This controls the depth and direction of Filter B cutoff modulation from LFO1, as described under "3-3a: LFO 1/2" on page 76.

#### **Filter LFO 2 Intensity to A. (-99...+99, Absolute)**

This controls the depth and direction of Filter A cutoff modulation from LFO2, as described under "3-3a: LFO 1/2" on page 76.

#### **Filter LFO 2 Intensity to B. (-99...+99, Absolute)**

This controls the depth and direction of Filter B cutoff modulation from LFO2, as described under "3-3a: LFO 1/2" on page 76.

#### **Pitch LFO 1 AMS Intensity. (-12.00...+12.00, Absolute)**

You can use an AMS source, such as aftertouch, to modulate the depth of pitch modulation (vibrato) from

LFO1. This controls the intensity of that AMS modulation. For more information, see “4-2c: LFO 1/2” on page 86.

**Pitch LFO 2 AMS Intensity. (-12.00...+12.00, Absolute)**  
This is similar to **Pitch LFO 1 AMS Intensity**, above.  
For more information, see “4-2c: LFO 1/2” on page 86.

*HD-1 Tone Adjust, Default Settings*

**Default Tone Adjust Settings**

Tone Adjust provides an elegant physical interface to the HD-1’s parameters. Most of the factory sounds use the default layout, as shown below. You can also customize the layout for individual sounds, if desired.

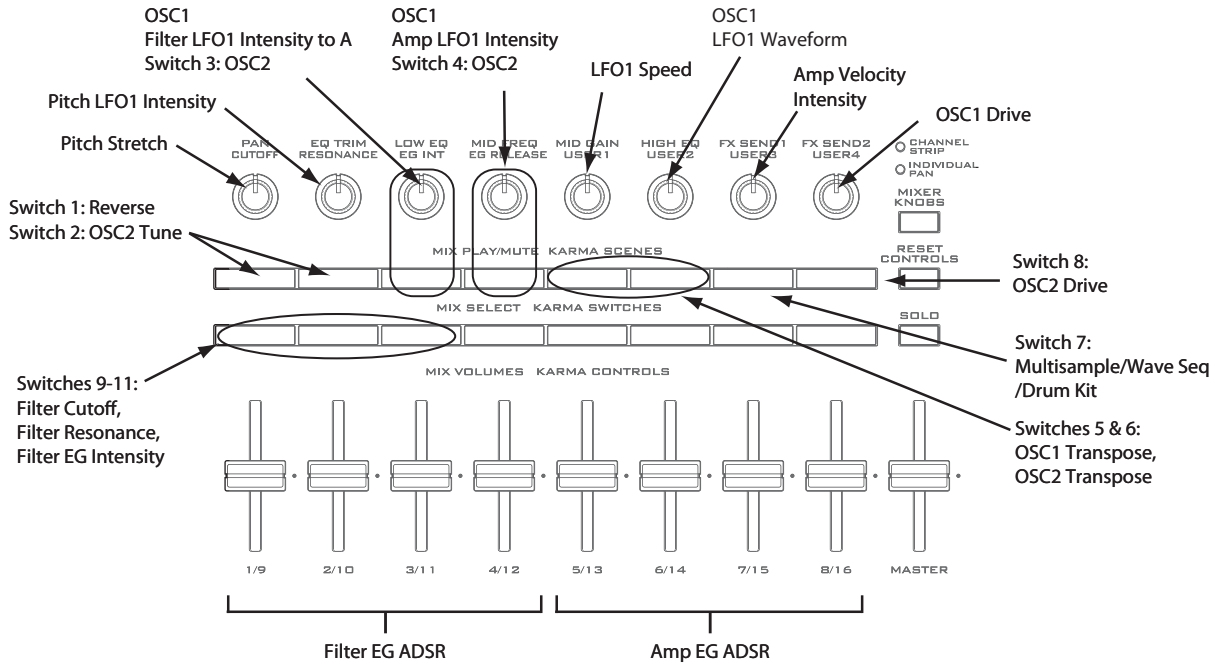

▼ **0-9: Page Menu Commands**

The number before each command shows its ENTER + number-key shortcut. For more information on these shortcuts, see “ENTER + 0-9: shortcuts for menu commands” on page 147.

- **0: Write Program.** For more information, see “Write Program” on page 147.
- **1: Exclusive Solo.** For more information, see “Exclusive Solo” on page 147.
- **2: Add to Set List.** For more information, see “Add To Set List” on page 148.
- **3: Copy Tone Adjust.** This is available only when **Control Assign** is set to **Tone Adjust**. For more information, see “Copy Tone Adjust” on page 152.
- **4: Reset Tone Adjust.** This is available only when **Control Assign** is set to **Tone Adjust**. For more information, see “Reset Tone Adjust” on page 153.
- **3: Copy Scene.** This is available only when **Control Assign** is set to **RT KNOBS/KARMA**. For more information, see “Copy Scene” on page 157.
- **4: Swap Scene.** This is available only when **Control Assign** is set to **RT KNOBS/KARMA**. For more information, see “Swap Scene” on page 157.

# Program P1: Basic/Vector

## 1-1: Program Basic

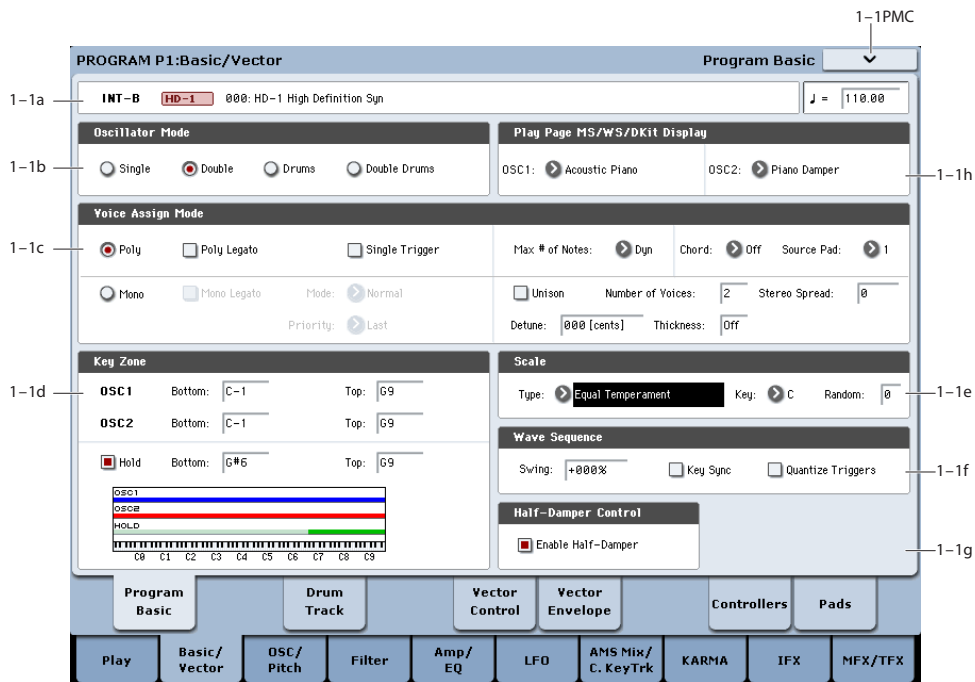

This page contains all of the basic settings for the Program. Among other things, you can:

- Set up the basic Program type: Single, Double, Drum, or Double Drum
- Set the Program to play polyphonically or monophonically
- Create a keyboard split between OSC 1 and OSC 2
- Select the Program’s scale
- Make basic Wave Sequence Settings

### 1-1a: Program Name and Tempo

**Bank** [INT-A...G, USER-A...G and AA...GG]

**Program Name** [000...127/001...128: Name]

These two read-only parameters show the bank, number, and name of the current Program.

**Tempo** (♩) [040.00...300.00, EXT]

This is the tempo used for Wave Sequences, LFOs, effects, and KARMA. For more information, please see “Tempo” on page 5.

### 1-1b: Oscillator Mode

**Oscillator Mode** [Single, Double, Drums, Double Drums]

HD-1 Single Programs have one oscillator, and Double Programs have two oscillators. Each oscillator includes a complete synthesis voice, with velocity-switched multisamples, dual filters, EGs, LFOs, and so on.

The Drum and Double Drum modes are a special variations of Single and Double modes, respectively, using Drum Kits (as created in Global mode) instead of Multisamples.

**Single:** The Program will use **one oscillator**, for a **maximum of 140-note polyphony**.

**Double:** The Program will use **two oscillators**, for a **maximum of 70-note polyphony**.

**Drums:** The Program will use **one oscillator** to play a Drum Kit. In this case the Program will normally have a **maximum of 140-note polyphony**.

**Double Drums:** The Program will use **two oscillators** to play two Drum Kits. In this case the Program will normally have a **maximum of 70-note polyphony**.

*Note:* when playing drum kits, it’s often useful to turn on the **Hold** parameter. For more information, see “Hold,” on page 39.

### A note about polyphony

Polyphony means the number of notes that you can play at a time. This number will vary depending on the particular sound being played, and how that sound is produced. Generally speaking:

- Double Programs use twice as many voices as Single Programs.
- A Wave Sequence uses twice as many voices as a Multisample. A stereo Wave Sequence uses twice as many voices as a mono Wave Sequence.
- Stereo Multisamples use twice as many voices as Mono Multisamples.
- If the Vector EG is enabled, the number of voices used increases slightly.

Polyphony also depends on the effects being used, and on which synthesis types are being used (HD-1, AL-1, CX-3 etc.). For more information, see “0-2: Performance Meters” on page 7.

## 1-1c: Voice Assign Mode

### Voice Assign Mode [Poly, Mono]

These radio buttons select the basic voice allocation mode. Depending on which one you select, various other options will appear, such as **Poly Legato** (Poly mode only) and **Unison** (Mono mode only).

**Poly:** The program will play polyphonically, allowing you play chords.

**Mono:** The program will play monophonically, producing only one note at a time.

### Poly

#### Poly Legato [Off, On]

Poly Legato is available when the **Voice Assign Mode** is set to **Poly**.

Legato means to play note so that they are smooth and connected; the next note is played before the last note is released. This is the opposite of playing detached.

**On (checked):** When you play a legato phrase, only the first note of that phrase (and notes within 30 msec of the first note) will use the normal multisample start point specified by **Start Offset** (2-1c); all subsequent notes will use the legato start point specified for each multisample.

*Note:* This is a useful way to simulate the percussive attack of a tonewheel-type organ.

**Off (unchecked):** Notes will always use the setting of the Start Point Offset, regardless of whether you play legato or detached.

⚠ With some Multisamples, Poly Legato may not have any effect.

#### Single Trigger [Off, On]

Single Trigger is available when the **Voice Assign Mode** is set to **Poly**.

**On (checked):** When you play the same note repeatedly, the previous note will be silenced before the next note is sounded, so that the two do not overlap.

**Off (unchecked):** When you play the same note repeatedly, the notes will overlap.

### Mono

#### Mono Legato [Off, On]

This is available when the **Voice Assign Mode** is set to **Mono**.

Legato means to play note so that they are smooth and connected; the next note is played before the last note is released. This is the opposite of playing detached.

When Mono Legato is On, the first note in a legato phrase will sound normally, and then subsequent notes will have a smoother sound, for more gentle transitions between the notes.

The **Mode** parameter, below, switches between two different Mono Legato effects, each of which achieves this smoothness in a different way. See the description of that parameter for more details.

**On (checked):** When you play with legato phrasing, the notes within a legato phrase will sound smoother, according to the setting of the **Mode** parameter, below.

**Off (unchecked):** Legato phrasing will produce the same sound as detached playing.

### Mode [Normal, Use Legato Offset]

This parameter is available only when **Mono Legato** is **On**.

**Normal:** When you play legato, the multisample, envelopes, and LFOs will not be reset; only the pitch of the oscillator will change. This setting is particularly effective for wind instruments and analog synth sounds.

⚠ With this option, the pitch may occasionally be incorrect, depending on which multisample you play, and where on the keyboard you play.

**Use Legato Offset:** When you play legato, the second and subsequent notes will use the legato start point specified for each multisample, rather than the **Start Offset** (2-1c) setting.

This is effective when used with a multisample for which you've assigned a specific legato offset point. For example, you might use it to control the attack of a breathy, slow-attack sax sound. On some multisamples, this will have no effect.

Envelopes and LFOs will still be reset, as they are with detached playing.

### Priority [Low, High, Last]

Priority is available when the **Voice Assign Mode** is set to **Mono**.

This parameter determines what happens when more than one note is being held down.

**Low:** The lowest note will sound. Many vintage, monophonic analog synths work this way

**High:** The highest note will sound.

**Last:** The most recently played note will sound.

### Max # of Notes

#### Max # of Notes [Dynamic, 1...16]

**Dynamic** is the default. With this setting, you can play as many notes as the system allows.

**1-16** lets you limit the maximum number of notes played by the Program. Voices will still be allocated dynamically, up to this maximum number. You can use this to:

- Model the voice-leading of vintage synthesizers, such as the Polysix
- Control the resources required by individual Programs in Combination and Sequencer modes

**Max # of Notes** applies only when the main **Voice Assign Mode** is set to **Poly**. If **Mono** is selected, this is grayed out.

This setting does not limit the **Unison Number of Voices** parameter. For instance, if **Max # of Notes** is set to 6, and **Unison Number of Voices** is set to 3, you can play up to 6 notes, each with 3 Unison voices.

If the Program is set to **Double**, the **Max # of Notes** applies equally to both Oscillators. For instance, if **Max # of Notes** is set to 4, you can play up to 4 notes on each OSC.

## Chord

### Chord [Off, Bsc, Adv]

**Off** disables the Chord function.

**Bsc** (Basic) re-creates the chord mode of the Korg Polysix. Each time you play a new chord, it will cut off the previous chord. This option ignores the Voice Assign settings.

**Adv** (Advanced) uses the Program's Voice Assign settings, as if each note in the chord was a transposed set of oscillators layered within the Program.

Poly, Poly Legato, Single Trigger, Mono, Mono Legato, Legato Offset, Mono Priority, and Mono and Poly Unison all apply.

You can achieve the same effect as **Bsc**, above, by setting **Chord** to **Advanced**, **Voice Assign** to **Mono**, **Priority** to **Last Note**, and **Legato** to **Off**.

For more information, see "Using Chord mode" on page 36 of the Operation Guide.

### Source Pad [1...8]

Chord mode uses the chords assigned to the on-screen pads, and this selects which one to use. You can also choose chords using the on-screen pads themselves; for more information, see "Selecting chords" on page 38 of the Operation Guide.

## Unison

### Unison [On, Off]

Unison can be used in both **Mono** and **Poly** modes.

**On (checked)**: When Unison is on, the Program uses two or more stacked, detuned voices to create a thick sound.

Use the **Number of Voices** and **Detune** parameters to set the number of voices and amount of detuning, and the **Thickness** parameter to control the character of the detuning.

**Off (unchecked)**: The Program plays normally. If **Unison** is **Off**, then all of its associated parameters are grayed out.

### Number of voices [2...16]

This controls the number of detuned voices that will be played for each note when using **Unison**. It applies only when **Unison** is **On**.

### Stereo Spread [0...100]

**Stereo Spread** lets you create a wider stereo field when using **Unison**. It applies only when **Unison** is **On**.

This feature separates the different Unison voices into two groups. One group is panned to the left, and the other to the right. At 0, both groups will be in the

center; at 100, the two groups will be hard-panned left and right, respectively; at intermediate values, they will be panned to intermediate left and right positions.

If there is an odd number of voices, one voice will be panned to the center.

If the voices are true stereo, **Stereo Spread** "steers" the stereo image of each voice, similar to MIDI Pan (CC#10) and the Control Surface Pan knobs. In this case, intermediate settings of **Stereo Spread** may be the most effective, since they will still preserve some of the original stereo image.

Unison detuning is spread as evenly as possible across the left and right channels. The lowest voice will be on the left, and the highest on the right; the next-lowest on the left, and the next-highest on the right, etc., as below:

-14 cents: L

+14 cents: R

-10 cents: L

+10 cents: R etc.

Depending on the **Thickness** setting, the detuning may lean slightly to one side.

### Detune [0...200 cents]

Detune is available when **Unison** is **On**.

This parameter sets the tuning spread for the Unison voices, in cents (1/100 of a semitone). The **Thickness** parameter, below, controls how the voices are distributed across the detune amount. When **Thickness** is **Off**, the voices are distributed evenly, centered around the basic pitch.

For instance, let's say that the **Number of voices** parameter is set to 3, **Detune** is set to 24, and **Thickness** is **Off**:

Voice one will be detuned down by 12 cents, voice two will not be detuned, and voice three will be detuned up by 12 cents.

Voice	Detune
1	-12
2	0
3	+12

As another example, let's say that **Detune** is still set to 24 and **Thickness** is still **Off**, but **Number of voices** is set to 4:

Voice one will still be detuned down by 12 cents, voice two will be detuned down by 4 cents, voice three will be detuned up by 4 cents, and voice 4 will be detuned up by 12 cents.

Voice	Detune
1	-12
2	-4
3	+4
4	+12

**Thickness** [Off,01...09]

Thickness is available when **Unison** is **On**.

This parameter controls the character of the detuning for the unison voices.

**Off:** Unison voices will be evenly distributed across the Detune range, as shown above.

**01-09:** Unison voices will be detuned in an asymmetric way, increasing the complexity of the detune, and changing the way in which the different pitches beat against one another. This creates an effect similar to vintage analog synthesizers, in which oscillators were frequently slightly out of tune. Higher numbers increase the effect.

---

**1-1d: Key Zone**

You can create keyboard splits by setting top and bottom keys for Oscillators 1 and 2. Also, you can control the keyboard range over which the **Hold** parameter takes effect.

**Setting Key Zones from the keyboard**

In addition to using the standard data entry controls, you can also set all keyboard zones parameters directly from the keyboard. Just do the following:

1. **Select the key zone parameter you'd like to edit.**
2. **Press and hold the ENTER button.**
3. **Play a note on the keyboard to set the parameter.**
4. **Release the ENTER button.**

You can use this shortcut for all key and velocity parameters in the KRONOS.

**Osc 1 Bottom** [C-1...G9]

This sets the lowest key on which Oscillator 1 will play.

**Osc 1 Top** [C-1...G9]

This sets the highest key on which Oscillator 1 will play.

**Osc 2 Bottom** [C-1...G9]

This sets the lowest key on which Oscillator 2 will play.

**Osc 2 Top** [C-1...G9]

This sets the highest key on which Oscillator 2 will play.

**Hold** [On, Off]

Hold is like permanently pressing down on the sustain pedal. In other words, notes continue to sound as if you were holding down the key - even after you lift your fingers from the keyboard.

Unless the **Sustain Level** is set to **0** in Amp EG 1 (and Amp EG 2 in a Double Program), the sound will play for the entire length of the sample(s).

**On (checked):** The **Hold** function is enabled for the range set by the **Hold Bottom** and **Hold Top** parameters, below.

**Off (unchecked):** Notes will play normally. This is the default setting.

**Using Hold with Drum Kits**

**Hold** can be especially useful for drum programs, since it lets the samples ring out naturally. In general, when you set the **Oscillator Mode** to **Drums**, it's good to set **Hold** to **On**.

Once you've turned on **Hold** for a drum program, the function is controlled on a note-by-note basis according to settings within the selected Drum Kit.

If a key's **Enable Note Off Receive** parameter (on the **Voice Mixer** tab of the **Drum Kit** page) is unchecked, the note will be held.

If the key's **Enable Note Off Receive** parameter is checked, it will not be held.

If you turn off **Hold** in the Program, no keys will be held - regardless of their **Enable Note Off Receive** setting.

**Using Hold with Acoustic Pianos**

Hold is also useful for simulating the top octaves of an acoustic piano, in which notes always sustain until they fade out naturally, regardless of how long you hold the key.

The **Hold Bottom** and **Hold Top** parameters are designed for exactly this purpose. They let you limit the effect of the Hold parameter to a specific range of the keyboard.

**Hold Bottom** [C-1...G9]

This sets the lowest key affected by the Hold function.

**Hold Top** [C-1...G9]

This sets the highest key affected by the Hold function.

---

**1-1e: Wave Sequence**

The **Swing**, **Key Sync**, and **Quantize Trigger** settings in this section affect how the Program plays its Wave Sequences. These settings are stored within the Program, and do not change the original Wave Sequence data.

**Swing** [-300%...+300%]

This parameter applies only when the Program is using one or more Wave Sequences set to Tempo mode.

Use **Swing** to add a sense of swing to the rhythm. For example, **Swing** provides an easy way to turn a "square" rhythm into a shuffle groove.

**Swing** works by adjusting the position of the up-beats, relative to the Wave Sequence's Resolution setting. For instance, if the Resolution is set to 1/8, **Swing** affects every other 8th note.

When **Swing** is set to **+100%**, these notes will be moved one third of the way toward the next down-beat. If the Resolution is 1/8, for example, **+100%** changes straight 8th notes into 8th note triplets.

When **Swing** is set to **+300%**, up-beats will be moved all the way to the next down-beat. At this point, the notes on the up-beats will not be heard at all.

Positive values make the up-beats later, and negative values make them earlier.



Wave Sequence Swing

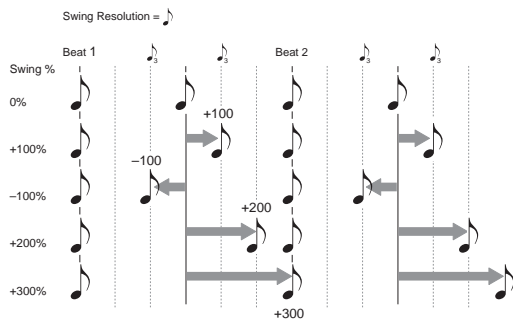

**Swing uses the Wave Sequence’s Resolution setting**

Since the programmed rhythms of Tempo Wave Sequences can vary widely, each has its own Swing Resolution setting, from 1/32 note triplets to 1/4 note.

If the Program contains two or more Wave Sequences with different Swing Resolution settings, the Program will use the finest value. For example, if one is set to 1/8 and the other is set to 1/16, the Program will use 1/16 notes.

**Key Sync [On, Off]**

**On (checked):** When Key Sync is On, each note’s Wave Sequence(s) will progress independently, so that each one can be on a different step, or moving at a different rate.

**Off (unchecked):** When Key Sync is Off, all of the Wave Sequences will be synchronized on the same step. There is one exception to this, however: if Duration is modulated with velocity or note-number, the Wave Sequences can still progress at different rates.

**Quantize Trigger [On, Off]**

This parameter applies only when the Program is using one or more Wave Sequences set to Tempo mode.

It allows you to force most Tempo-mode Wave Sequence note-ons to be in sync, making it easier to play along with other rhythmic elements.

When Quantize Triggers is On, note-ons are quantized to 8th notes using the current tempo reference. (See below for a few more details.)

The tempo reference can come from different sources, depending on the current mode, and whether or not KARMA is on:

- In Program and Combi modes, if KARMA is off, note-ons are synchronized with the sounding Tempo-mode Wave Sequence, if any.
- In Program and Combi modes, if KARMA is on, note-ons are synchronized with KARMA.
- In Sequencer mode during playback or recording, note-ons are synchronized with the sequence.
- In Sequencer mode, while the sequencer is stopped, note-ons are synchronized with RPPR and KARMA.

**On (checked):** Note-ons will be quantized.

**Off (unchecked):** Note-ons will be played instantly, the moment that you play the keyboard.

**How Quantize Trigger works**

The Quantize Trigger feature tries to make a good guess at where you intended the note to be. If you play the note just a bit late—within a 32nd note of the 8th note—it will assume that you meant the note to sound on the beat that just passed. In this case, the note will play immediately.

On the other hand, if you play the note up to three 32nd notes early, it will assume that you’re intending the note to sound on the next beat. In this case, the note-on is delayed until the next 8th note.

**1–1f: Half-Damper Control**

A half-damper pedal is a special type of continuous foot pedal, such as the Korg DS-1H. In comparison to a standard footswitch, half-damper pedals offer more subtle control of sustain, which can be especially useful for piano sounds.

The KRONOS will automatically sense when a half-damper is connected to the rear-panel DAMPER input. For proper operation, you will also need to calibrate the pedal, using the Calibrate Half-Damper command in the Global page menu.

The off and full-on positions of the half-damper work just like a standard footswitch. In conjunction with the **Enable Half-Damper** parameter, below, intermediate positions allow a graduated control of sustain, similar to the damper pedal of an acoustic piano.

**Enable Half-Damper [On, Off]**

When this is **On** (checked), Half-Damper pedals, normal sustain pedals, and MIDI CC# 64 will all modulate the Amp EG, as described below.

When this is **Off** (un-checked), the pedals and MIDI CC#64 will still hold notes as usual, but will not modulate the Amp EG.

**Half-Damper Pedal and Release Time**

The amount of modulation depends on whether the Amp EG **Sustain Level** is set to 0 (as is the case with most acoustic piano sounds), or set to 1 or more. The modulation is continuous, from 1x (no change) to 55 times longer; the table below shows a selection of representative points.

*Half-Damper modulation of Amp EG Release Time*

CC#64 Value	Multiply Amp EG Release Time by...	
	If Sustain = 0	If Sustain = 1 or more
0	1x	1x
32	2.1x	2.1x
64	3.2x	3.2x
80	5.9x	
96	22.3x	
127	55x	



## 1-1g: Scale

### Type [Equal Temperament...User Octave Scale15]

Selects the basic scale for the Program.

Note that for many of the scales, the setting of the **Key** parameter, below, is very important.

**Equal Temperament:** This is the most widely used scale by far, in which each semitone step is spaced at equal pitch intervals.

Equal Temperament allows easy modulation, so that a chord progression played in the key of C sounds roughly the same as the same progression played in F#. Sacrificed, however, is some of the purity of individual intervals offered by the scales below.

**Pure Major:** In this temperament, major chords of the selected key will be perfectly in tune.

**Pure Minor:** In this temperament, minor chords of the selected key will be perfectly in tune.

**Arabic:** This scale includes the quarter-tone intervals used in Arabic music.

**Pythagoras:** This scale is based on ancient Greek musical theory, and is especially effective for playing melodies. It produces completely pure fifths, with one exception, at the expense of detuning other intervals—thirds in particular.

As much as Pythagoras might have like to do so, it's not possible to make all the fifths pure while also keeping the octave in tune. For the sake of the octave, one of the fifths—the interval from the sharp fourth degree to the sharp first degree—is made quite flat.

**Werkmeister** (Werkmeister III): This scale was one of the many temperament systems developed towards the end of the Baroque period. These "Well-Tempered" tunings were aimed at allowing relatively free transposition—although you'll still notice that the different keys maintain their own distinct characteristics, unlike Equal Temperament.

J.S. Bach was referring to these new scales in his title, "The Well-Tempered Clavier." As such, this group are particularly appropriate for late baroque organ and harpsichord music.

**Kirnberger** (Kirnberger III): This is a second "Well-Tempered" tuning, dating from the early 18th century.

**Slendro:** This is an Indonesian gamelan scale, with five notes per octave.

When **Key** is set to C, use the C, D, F, G and A notes. Other keys will play the normal equal-tempered pitches.

**Pelog:** This is another Indonesian gamelan scale, with seven notes per octave.

When **Key** is set to C, use the white keys. The black keys will play the equal tempered pitches.

**Stretch:** This tuning is used for acoustic pianos.

**User All Notes Scale:** This is a user-programmed scale with different settings for all 128 MIDI notes. You can set up this scale in Global mode (Global 3-1b).

**User Octave Scale 00-15:** These are user-programmed scales with settings for each of the 12 notes in an octave. You can set them up in Global mode (Global 3-1a).

### Key (Scale Key) [C...B]

Selects the key of the specified scale.

This setting does not apply to the **Equal Temperament**, **Stretch**, and **User All Notes** scales.

 If you're using a scale other than Equal Temperament, the combination of the selected scale and the **Key** setting may skew the tuning of the note. For example, A above middle C might become 442 Hz, instead of the normal 440 Hz. You can use the Global Mode's **Master Tune** parameter to correct this, if necessary.

### Random [0...7]

This parameter creates random variations in pitch for each note. At the default value of 0, pitch will be completely stable; higher values create more randomization.

This parameter is handy for simulating instruments that have natural pitch instabilities, such as analog synths, tape-mechanism organs or acoustic instruments.

## 1-1h: Play Page MS/WS/DKit Display

### OSC1 [MS/WS/DK Names, (List of Graphics)]

This works in conjunction with the P0 Play page's **Show MS/WS/DKit Graphics** menu command (and its corresponding Global parameter) to control whether the main P0 Play page shows the overview/jump parameters (the graphical envelopes, LFOs, etc.), or the selected graphics.

If the **Show MS/WS/DKit Graphics** menu command is not enabled, then the overview/jump parameters will be shown regardless of the setting here.

If **Show MS/WS/DKit Graphics** is enabled (checked), then this parameter takes effect. See also "Show MS/WS/DKit Graphics" on page 148.

**MS/WS/DK Names** shows the names of Osc 1's Multisamples, Wave Sequences, or Drum Kit as part of the overview/jump parameters.

If a graphic is selected, then the graphic will be shown instead of the normal overview/jump parameters.

### OSC2 [MS/WS/DK Names, (List of Graphics)]

This controls the P0 Play page display for Osc 2. It works the same as "OSC1," above.

## ▼ 1-1: Page Menu Commands

The number before each command shows its ENTER + number-key shortcut. For more information on these shortcuts, see "ENTER + 0-9: shortcuts for menu commands" on page 147.

- 0: **Write Program.** For more information, see "Write Program" on page 147.
- 1: **Exclusive Solo.** For more information, see "Exclusive Solo" on page 147.

- 2: **Copy Oscillator**. For more information, see “Copy Oscillator” on page 153.
- 3: **Swap Oscillators**. For more information, see “Swap Oscillator” on page 153.

## 1-3: Drum Track

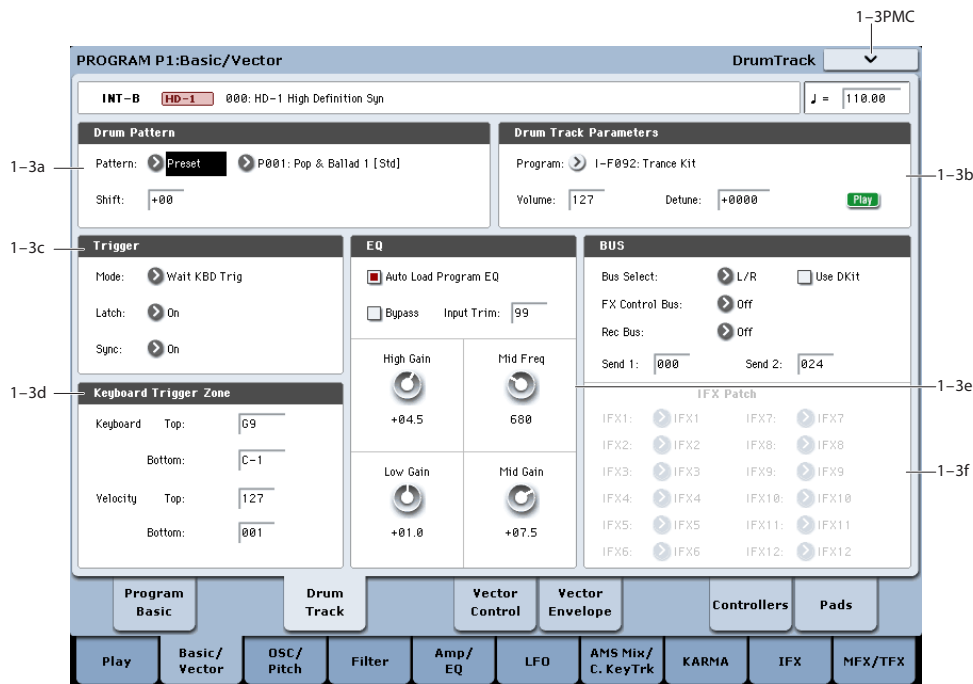

### Overview

The Drum Track is a built-in drum machine, fueled by the KRONOS's high-quality drum sounds.

There are hundreds of preset Drum Track patterns covering a wide range of musical styles, and you can also create your own (as we'll explore later in this chapter).

There are options to control how the Drum Track pattern starts, such as starting immediately when you press the DRUM TRACK button, or waiting until you start to play the keyboard. If you're starting the pattern by playing the keyboard, you have the option of starting it by using a specific range of notes or velocities.

You can also link the Drum Track with KARMA, so that they play in sync and start and stop together.

In Program mode, the Drum Track has its own mixer channel (including EQ) and separate effects routing, for independent control of the sound.

For more information, see “Using the Drum Track” on page 237 of the Operation Guide.

### 1-3a: Drum Pattern

#### Bank [Preset, User]

This selects between Preset and User Patterns.

The Patterns in the Preset bank are from the factory, and can't be changed.

The User bank Patterns are editable; you can load them from disk, or create new ones in Sequencer mode.

#### Pattern [(Preset): P000...P697, (User): U000...U999]

This chooses the Pattern from the selected Bank.

#### Shift [-24...+24]

**Shift** lets you transpose the Drum Track pattern in semitone steps, causing different instruments of the drum kit to play. This will generally cause unexpected results, which may often be interesting—experiment and see!

### 1-3b: Drum Track Program

This area contains a few parameters for adjusting the basic sound of the Drum Track.

#### Program [List of Programs]

This selects a sound for the Drum Track, via the Category/Program Select dialog. By default, the Drum category will already be selected.

You can actually select any sound, even outside of the Drum category—but in general, the patterns will only make sense when playing a Drum Program.

*Note:* GM Drum Programs use a different mapping of sounds to MIDI notes, and so the Drum Track Patterns may not always sound as expected. In some cases, setting **Shift** to -12 may correct the mapping.

#### Volume [0...127]

This controls the volume level of the Drum Track Program, separately from the main Program.

You can also adjust this from the Control Surface, using slider 3 in Timbre/Track mode.

**Detune** [-1200...+1200]

This adjusts the overall pitch of the Drum Program in one-cent increments. One cent is 1/100th of a semitone.

You can adjust the pitch of individual drum samples by editing Drum Kits in Global mode.

**Play/Mute** [Mute, Play]

This determines whether or not the Drum Track Program will sound. The setting will alternate each time you press the Play/Mute button.

**Mute:** The timbre will not sound.

**Play:** The timbre will sound.

You can also adjust this from the Control Surface, using Mix Play/Mute button 3 in Timbre/Track mode.

---

**1–3c: Trigger**

**Mode** [Start Immediately, Wait KBD Trig]

This controls how the pattern will start and stop.

**Start Immediately:** When you turn on the Drum Track by pressing the DRUM TRACK switch, the LED will light and the Drum Track pattern will start according to the **Sync** setting. It will stop when you turn off the switch.

**Wait KBD Trig:** When you press the DRUM TRACK switch to turn it on, the LED will blink and the Drum Track pattern will wait to start. When you play the keyboard or receive a MIDI note-on, the Drum Track pattern will start according to the **Sync** setting.

The **Mode** setting also affects the way in which the on/off status of the DRUM TRACK switch is stored.

With **Wait KBD Trig**, the on/off status of the DRUM TRACK switch is also saved when you save the Program.

With **Start Immediately**, the switch status is always saved as Off, regardless of the whether the switch is on or off when you Write.

**Latch** [On, Off, Use KARMA Latch Switch]

**Latch** controls whether the Drum Track pattern will continue playing even after you take your hands off of the keyboard. This applies when the **Trigger Mode** is set to **Wait KBD Trig**.

**Off:** If the DRUM TRACK switch is on, the LED will blink, and the pattern will start when you play the keyboard. When you stop playing, the Drum Track will stop as well.

**On:** If the DRUM TRACK switch is on (the LED will blink), the pattern will start when you play the keyboard (note-on). The pattern will continue when you release the keyboard (note-off). The pattern will stop when you turn the DRUM TRACK switch off (the LED will go dark).

**Use KARMA Latch Switch:** The on/off status of the KARMA LATCH switch will correspond to the above Off and On modes of operation. You will probably want to use this in conjunction with KARMA's Latch operation.

**Sync** [On, Off]

If you want the Drum Track pattern to play in sync with KARMA (or with the Sequencer, in Sequencer mode), turn Trigger **Sync** on.

**Trigger Sync On:** The Drum Track's start will synchronize to the currently-playing KARMA pattern, quantized to the nearest beat. In Sequencer mode, triggering will synchronize to the currently-playing song, pattern or RPPR performance, quantized to the nearest measure.

*Note:* If you want to synchronize KARMA to the Drum Track, enable the **Quantize Trigger** parameter (Prog P7: KARMA– Trigger, Combi/Seq P7: KARMA– Trigger A/B/C/D).

*Note:* In Sequencer mode, if you want to synchronize the RPPR pattern performance to the currently-running Drum Track, set the **Sync** parameter to Beat or Measure.

**Trigger Sync Off:** If the **Trigger Mode** is set to Start Immediately, the Drum Track pattern will be triggered the moment you press the DRUM TRACK switch. If this is set to Wait KBD Trig, the Drum Track pattern will be triggered the moment you play the keyboard. It will not synchronize to the currently-playing KARMA pattern or (in Sequencer mode) to the currently-playing song, pattern, or RPPR.

---

**1–3d: Keyboard Trigger Zone**

These settings specify the range of keys and velocities that will trigger the Drum Track pattern when you play the keyboard (or the system receives a note-on via MIDI).

**Keyboard Top** [C–1...G9]

Specifies the highest note that will trigger the Drum Track Pattern.

**Bottom** [C–1...G9]

Specifies the lowest note that will trigger the Drum Track Pattern.

**Velocity Top** [1...127]

Specifies the maximum velocity value that will trigger the Drum Track Pattern.

**Bottom** [1...127]

Specifies the minimum velocity value that will trigger the Drum Track Pattern.

**Key and Velocity** settings can also be edited by holding down the ENTER switch and playing on the keyboard.

 The Keyboard and Velocity Top settings must be higher than their respective Bottom settings.

### 1–3e: EQ

This 3-band EQ is dedicated to the Drum Track Program, and is completely separate from the main Program's EQ.

#### Auto Load Program EQ [On, Off]

**On (checked):** When you change the drum track Program, the new Program's EQ values will be copied automatically. This setting is the default.

After the Program is loaded, you can still edit the EQ settings as desired.

**Off (unchecked):** Newly selected Drum Track Program's EQ settings will not replace the current EQ settings. Use this if you've edited the EQ settings, and want to keep them constant while listening to different Drum Track Programs.

#### Bypass [On, Off]

When Bypass is checked, all of the EQ will be disabled, including the Input Trim.

Bypass can be convenient for comparing the results of the EQ with the original signal.

#### Input Trim [00...99]

This controls the volume level going into the EQ.

High settings of the Low, Mid, and High Gain controls can cause substantial increases in the overall level. You can compensate for this by turning down the input trim.

#### Low Gain [-18.0...+18.0dB]

This controls the gain of the 80Hz Low Shelf EQ, in increments of 0.5dB.

#### Mid Frequency [100Hz...10.00kHz]

This sets the center frequency for the Mid sweep EQ.

#### Mid Gain [-18.0...+18.0dB]

This controls the gain of the Mid Sweep EQ, in increments of 0.5dB.

#### High Gain [-18.0...+18.0dB]

This controls the gain of the 10kHz High Shelf EQ, in increments of 0.5dB.

### 1–3f: Bus

These parameters control the output and effects routing for the Drum Track Program.

#### Bus Select [L/R, IFX1...12, 1...4, 1/2...3/4, Off]

This specifies the output bus for the Drum Track Program.

**L/R:** The Program will go to the L/R bus. This is the default setting.

**IFX1...12:** The Program will go to the specified IFX bus.

**1...4:** The Program will be routed in mono to the specified AUDIO OUTPUT (INDIVIDUAL).

**1/2...3/4:** The Program will be routed in stereo, using the Pan setting, to the specified AUDIO OUTPUT (INDIVIDUAL) pair.

**Off:** The Program will not go to any of the outputs directly. You can use this to route the sound completely through the MFX. Use **Send1 (to MFX1)** and **Send2 (to MFX2)** to specify the send levels.

#### Use Dkit [Off, On]

**On (checked):** Drum Kits can have different **Bus Select**, **FX Control Bus**, **Send 1**, and **Send 2** settings (Global 5–3b) for each key. When **Use Dkit** is **On**, these per-key settings will be used. You can use this to apply individual insert effects to specific drum instruments, or to send specific drum instruments to individual outputs.

*Tip:* Most of the factory Drum Kits use standard **Bus Select** settings, as detailed below:

Snares → IFX1

Kicks → IFX2

Toms → IFX3

Cymbals → IFX4

Percussion, etc. → IFX5

For flexibility in assigning the sounds to different IFX busses, you can use the "IFX Patch" parameters, below.

**Off (unchecked):** The **Bus Select**, (8–1c) **FX Control Bus**, (8–1d), "8–1f: OSC MFX Send" **OSC MFX Send** settings will be used. All drum instruments will be sent to the specified bus.

#### FX Control Bus [Off, 1, 2]

This sends the output of the Drum Track Program to an FX Control bus (two-channel stereo FX Ctrl 1 or 2).

Use the FX Control busses when you want a separate sound to control the audio input of an effect. You can use two FX Control busses (each is a two-channel stereo bus) to control effects in various ways.

For more information, please see "FX Control Buses" on page 860.

#### Rec Bus [Off, 1...4, 1/2, 3/4]

These settings send the output of the Drum Track Program to the REC busses (four mono channels: 1, 2, 3, 4).

The REC busses are dedicated internal busses for recording, used for sampling in the various modes or for recording audio tracks in Sequencer mode.

For more information, see "REC Bus" on page 138.

**Off:** The signal will not be sent to a REC bus. This is the default.

**1...4:** The Drum Program will be sent, in mono, to the corresponding REC bus. The **Pan** setting will be ignored.

**1/2, 3/4:** The Drum Program will be sent in stereo to the selected pair of REC busses.

#### Send1 (to MFX1) [000...127]

Sets the volume (send level) at which the output of the Drum Program will be sent to master effect 1. This applies only when **Bus Select** (8–1c) is set to **L/R** or **Off**.

If **Bus Select** is set to **IFX1–IFX12**, the send levels to master effects 1 and 2 are set by **Send 1** and **Send 2** (8–5a) after passing through IFX1–12.

**Send2 (to MFX2) [000...127]**

Sets the volume (send level) at which the output of the Drum Program will be sent to master effect 2.

**IFX Patch**

As noted above, Drum Kits can have different **Bus Select** settings for each key, as set on the Global P5–3 Voice Assign/Mixer page. Since the Drum Program shares the effects with the main Program, these routings may or may not make sense; for instance, while the Drum Program may have originally had a compressor in IFX1, the main Program may have a vocoder.

This group of parameters lets you re-direct the Drum Program’s individual **Bus Select** settings. Continuing from the above, if some of the keys were set to go to IFX1, you can route them to an unused IFX instead - maybe IFX9, for instance. Add a compressor in IFX9, and you’re now good to go.

See “Use Dkit,” above, for notes on the typical routings for the factory Drum Kits.

This section appears only if **Use Dkit** is **On**. Note also that if the Drum Kit doesn’t use routing to the IFX busses, these parameters will have no effect.

**IFX1 [L/R, IFX1...12, 1...4, 1/2...3/4, Off]**

This re-route the Drum Program sounds assigned to IFX1, and re-routes them to the selected bus.

**IFX2...12 [L/R, IFX1...12, 1...4, 1/2...3/4, Off]**

These work the same as “IFX1,” above.

Note: If you want to return the drum kit to its previous state, change these settings to IFX1=IFX1, IFX2=IFX2, and so on.

---

**▼ 1–3: Page Menu Commands**

The number before each command shows its ENTER + number-key shortcut. For more information on these shortcuts, see “ENTER + 0-9: shortcuts for menu commands” on page 147.

- 0: **Write Program**. For more information, see “Write Program” on page 147.
- 1: **Exclusive Solo**. For more information, see “Exclusive Solo” on page 147.
- 2: **Copy Drum Track**. For more information, see “Copy Drum Track” on page 163.
- 3: **Erase Drum Track Pattern**. For more information, see “Erase Drum Track Pattern” on page 635.

## 1-5: Vector Control

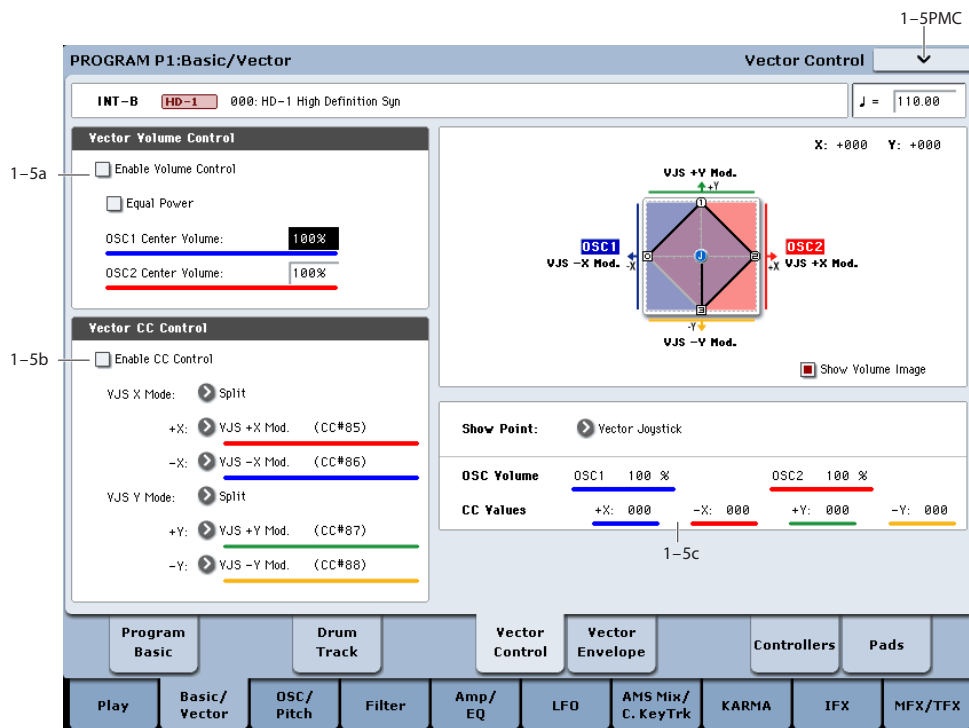

Vector Synthesis lets you control Program and Effects parameters by moving the Vector Joystick, by using the programmable Vector Envelope, or by the combination of the two.

### What does Vector mean?

Modulation generally works by moving a single control, like a slider, in a straight line. At one end of the control, the modulation is at its minimum; at the other end, it's at its maximum.

Vector Synthesis is a little different. It works by moving around a point on a two-dimensional plane, both left-right and up-down.

Vector Point and X and Y axis values

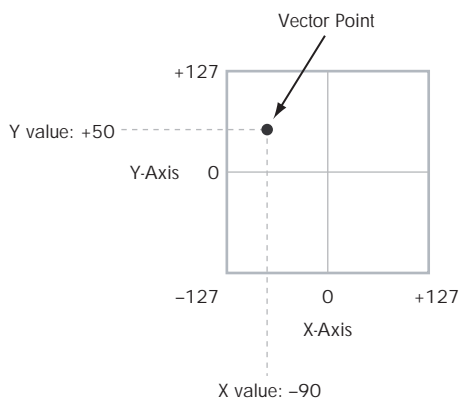

You can think of this point as being positioned on two different lines at once: a left-right line (the X axis), and an up-down line (the Y axis).

In other words, instead of just having one value (like a slider), each Vector point has two values: one for X, and one for Y. See the graphic "Vector Point and X and Y axis values" for an example.

In addition to moving the point directly with the Vector Joystick, you can also use the Vector Envelope to move its position automatically over time, as shown below.

Vector Envelope moving the Vector Point

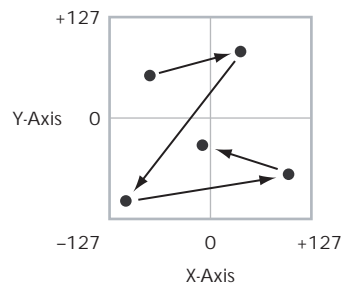

### Vector Joystick and Vector Envelope

You can move the Vector point using the combination of the Vector Joystick and the Vector Envelope. The two work together, although you don't necessary have to use them both at the same time.

When the Vector Joystick is in its center position, the Vector Envelope has complete control over the point's position. Likewise, when the Vector Envelope is in the center, the Vector Joystick has complete control.

When the Vector Envelope is moving, the Vector Joystick scales its effect. Regardless of the Envelope's position, the Vector Joystick can always move the Vector point all the way to any of the extreme edges.

*Tip:* to quickly reset the Vector Joystick to its center value, hold down the front-panel Control Reset button and move the joystick.



### Vector Volume Control and CC Control

The Vector does two main things: it can control the relative volume of the two Oscillators in Program mode (or of up to 16 Programs at once in Combi mode), and it can generate CCs for controlling Program and Effects parameters.

### Vector and MIDI

The Vector features interact with MIDI in two different ways: through the Vector Joystick, and through the Vector CC Control.

The **Vector Joystick** sends and receives two MIDI controllers: one for the X axis, and the other for the Y axis. In Global mode, you can assign these to any MIDI CC numbers you like. The defaults are CC#118 for the X axis, and CC#119 for the Y axis.

The Vector Joystick and its CCs *control* the Vector position, in conjunction with the Vector EG.

The **Vector CC Control**, on the other hand, is *generated by* the Vector position. Normally, this will only affect internal sounds and effects. If you like, however, you can use a Global parameter to send these generated CCs to external MIDI devices; for more information, see “Vector MIDI Out” on page 773.

### 1–5a: Vector Volume Control

Vector Volume Control lets you adjust the relative volumes of Oscillators 1 and 2 by moving the Vector Joystick (or the Vector Envelope) from left to right on the X axis. The Drum Track is not affected.

The **Equal Power** check-box makes the Vector create a smooth fade between the two Oscillators, while the OSC1/2 Center Volume parameters allow you to create more complex fade shapes.

In Combi mode, you can use this to control the relative volumes of up to 16 Programs at once, using both the X and Y axes. For more details, see the Vector Control section of Combi mode.

### Enable Volume Control [Off, On]

When this box is checked, the Vector position will control the volumes of Oscillators 1 and 2.

When this box is not checked, the Vector position will not directly affect volume. However, it’s still possible for the Vector to control volume via Vector CCs and AMS.

### Equal Power [Off, On]

This applies only when **Enable Volume Control** is turned **On**.

When **Equal Power** is **On**, the Vector will fade between Oscillators 1 and 2 using an equal-power volume curve. This provides a smooth fade between the two sounds, and is the type of volume control used by classic vector synths.

Also, when this is checked, the OSC 1 and OSC 2 **Center Volume** parameters will be grayed out, since Equal Power sets the center volumes automatically.

When **Equal Power** is **Off**, the OSC 1 and OSC 2 **Center Volume** parameters determine the way in which Vector position affects volume.

### OSC1 Center Volume [0, 25, 50, 75, 100%]

This sets the volume of Oscillator 1 at the center of the X axis. It applies only when **Equal Power**, above, is set to **Off**.

The volumes at the extreme ends of the X axis are fixed. At the left side, Osc 1 is always at 100% volume; at the right side, Osc 1 is always at 0%.

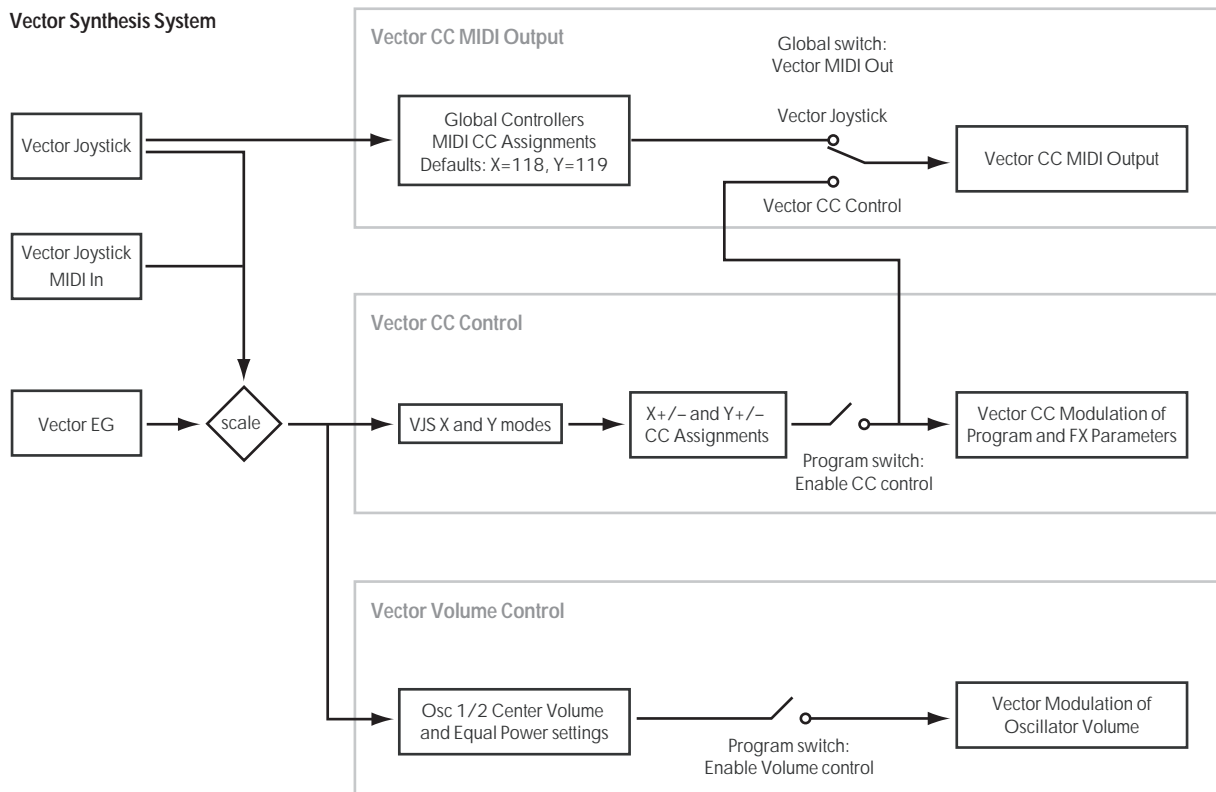

**OSC2 Center Volume [0, 25, 50, 75, 100%]**

This sets the volume of Oscillator 2 at the center of the X axis.

The volumes at the extreme ends of the X axis are fixed, in the opposite direction of Oscillator 1's. At the left side, Osc 2 is always at 0% volume; at the right side, Osc 2 is always at 100%.

*Osc Center Volume and X-Axis Position*

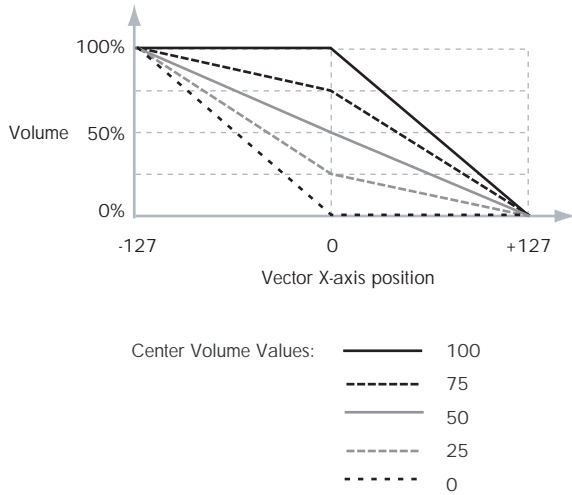

**1-5b: Vector CC Control**

Vector CC Control lets you use the combination of the Vector Joystick and the Vector EG as AMS sources, for modulating Program parameters, and as DMod sources, for modulating Effects.

Each of the four directions of the Vector can send a different CC, including left (-X), right (+X), up (+Y), and down (-Y). You can choose between several different patterns combining these four directions by using the VJS X Mode and VJS Y Mode parameters.

You can either use the Vector CCs to automate existing modulation routings, such as the front-panel knobs, or as distinct modulation sources. The vector CC is transmitted as MIDI control change messages on the global MIDI channel. This means that it controls all voices of the program, not individual voices.

*Note:* A Global parameter allows you to enable or disable MIDI output for the CC Control. By default, this is disabled. This setting does not affect the internal Programs, which can always receive the Vector CCs.

**Enable CC Control [Off, On]**

When this box is checked, the Vector position will control the CCs assigned to +X, -X, +Y, and -Y, as set below.

When this box is not checked, the Vector position will not affect these CCs. However, the joystick will still send and receive its dedicated MIDI CCs, just like other physical controllers. See "Vector and MIDI," above, for more information.

**VJS X Mode [Positive, Negative, Xfade, Split]**

You can set up the Vector to send out CCs in several different patterns, as shown in the graphic below. This controls the pattern for the X axis. Note that this setting affects only CC Control; it has no effect on Volume Control.

*Vector CC Modes*

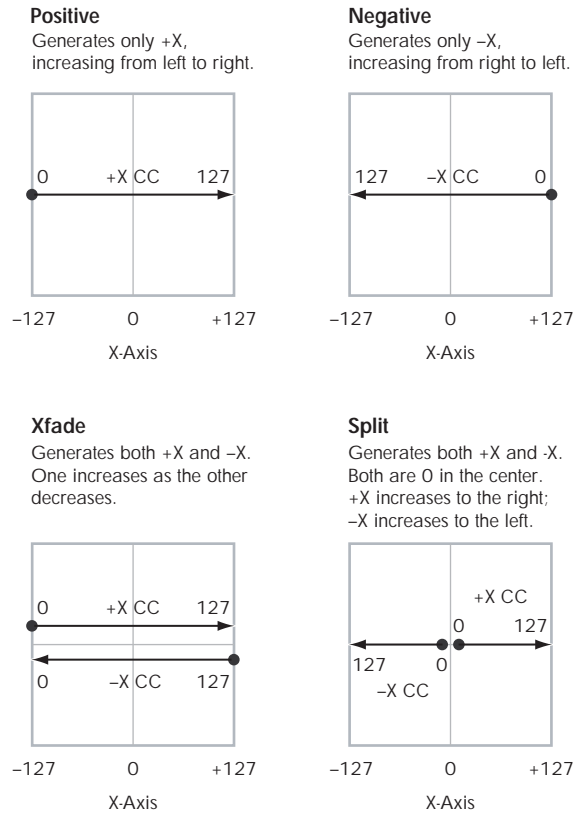

**Positive** sends out only +X, starting at 0 at the far left, and increasing to 127 at the far right. -X is disabled in this mode.

**Negative** sends out only -X, starting at 0 at the far left, and increasing to 127 at the far right. In this mode, +X is grayed out.

**Xfade** sends out both +X and -X, overlapping throughout the X axis. As one increases, the other decreases.

**Split** sends out both +X and -X, with a split in the center. +X is sent when the point moves to the right of the center, and -X is sent when the point moves to the left of center.

**+X [Off...MIDI CC#119]**

This assigns the controller sent by the +X vector. You can use this as an AMS source to control Program parameters, or as a DMod source to control Effects parameters. It will be grayed out if the VJS X Mode, above, is set to Negative.

In addition to the standard list of MIDI controllers, you can also assign the +X vector to duplicate the function of several front-panel controllers, including JS X, JS+X, JS-X, Knobs 5-8, and SW 1-2.

For instance, if you assign +X to Knob 6, the vector's +X will use the controller assigned to Knob 6 on the Controller Assign page.



Finally, you can also assign +X to control the Master Volume.

**–X [Off...MIDI CC#119]**

This assigns the controller sent by the –X vector. It will be grayed out if the VJS X Mode, above, is set to Positive.

The selections are the same as for +X, above.

**VJS Y Mode [Positive, Negative, Xfade, Split]**

This controls the Vector CC pattern for the Y axis. For more information, see the description under VJS X Mode, above.

**+Y [Off...MIDI CC#119]**

This assigns the controller sent by the +Y vector. It will be grayed out if the VJS Y Mode, above, is set to Negative.

The selections are the same as for +X, above.

**–Y [Off...MIDI CC#119]**

This assigns the controller sent by the –Y vector. It will be grayed out if the VJS Y Mode, above, is set to Positive.

The selections are the same as for +X, above.

---

## 1–5c: Vector Graphic

### Vector Graphic

This is a diagram of the vector space, including the five points of the Vector EG (labeled 0–4) and the current position of the Vector Joystick (labeled J).

The transitions between the EG’s points are shown by black lines, and the loop transition is shown by a gray line.

**Show Volume Image [Off, On]**

The vector graphic includes an image representing the current Vector Volume Control settings. You can use the Show Volume Image check-box to toggle this part of the graphic on and off.

**Show Point [Vector Joystick, Vector Envelope Point 0...4]**

You can view the volume and CC values for the current position of the Vector Joystick, or for any of the EG’s five points.

### Oscillator Volume & CC Display

This read-only display shows the volume and CC values for the current Vector point, as selected by the Show Point parameter, above.

- 2: **Copy Oscillator.** For more information, see “Copy Oscillator” on page 153.
- 3: **Swap Oscillators.** For more information, see “Swap Oscillator” on page 153.

---

## ▼ 1–5: Page Menu Commands

The number before each command shows its ENTER + number-key shortcut. For more information on these shortcuts, see “ENTER + 0-9: shortcuts for menu commands” on page 147.

- 0: **Write Program.** For more information, see “Write Program” on page 147.
- 1: **Exclusive Solo.** For more information, see “Exclusive Solo” on page 147.

## 1-6: Vector Envelope

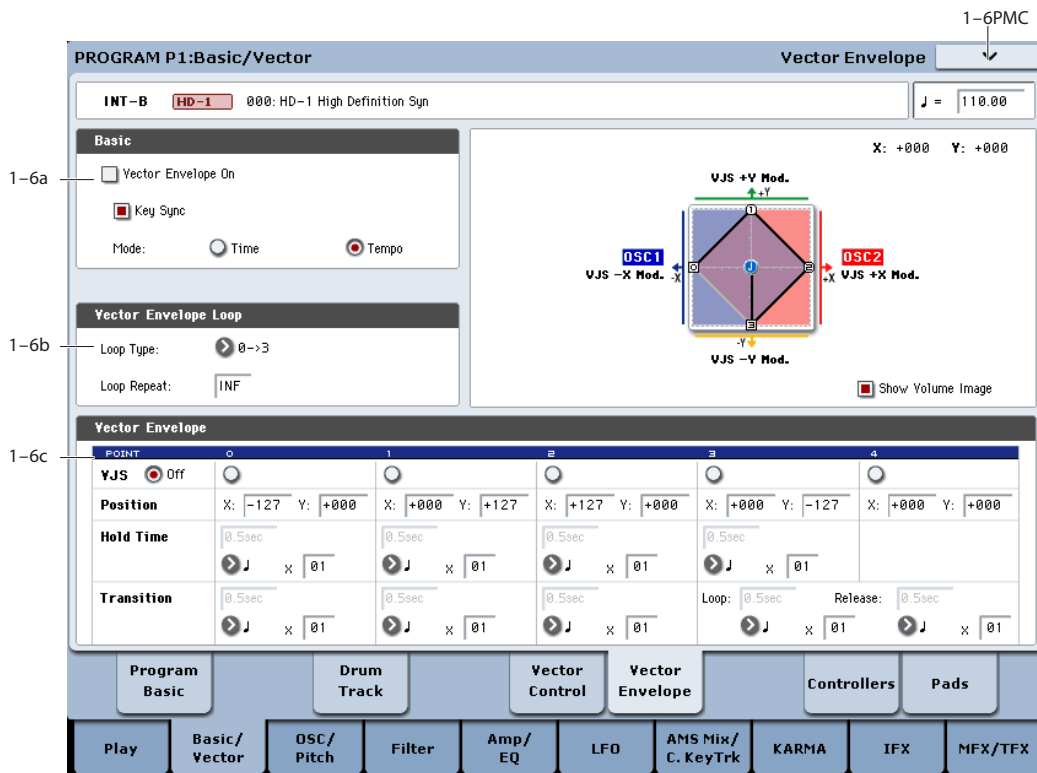

The Vector Envelope works together with the Vector Joystick to control the Vector position. It's also special because it's the only programmable modulation source which lets you modulate both Program and Effects parameters.

The Vector Envelope is different from the other envelopes in several ways:

- Each point has two “levels” - one for the X axis, and one for the Y axis.
- The envelope times can be based on seconds and milliseconds, or synced to tempo.
- Each point has a hold time, as well as a transition time to the next point.
- The envelope can loop between two points, for either a specified number of repeats, or as long as you hold the note.

### Vector Volume and CC control use separate EGs

There are actually two different Vector EGs, which share the same parameters: one for Volume Control, and the other for CC Control.

All of the notes in the Program share a single CC Control EG, since there can only be one set of CCs for each MIDI channel. This EG starts when you first play a note, and continues as long as any notes are held down on the keyboard. When you release all of the notes, the EG goes into its release phase.

Each note then has its own, additional Volume Control EG. The **Key Sync** parameter applies only to this per-note EG.

When the **Key Sync** parameter is **Off**, the CC Control and Volume Control EGs are completely synchronized.

When **Key Sync** is **On**, each note's Volume Control EG will start at note-on, and go into release at note-off. All the notes will still share a single CC Control EG.

### 1-6a: Basic

#### Vector Envelope On [Off, On]

**On (checked):** When this box is checked, the Vector EG will work with the Vector Joystick to control the vector position.

**Off (unchecked):** When this box is not checked, the Vector EG will not run. The vector position will be controlled solely by the Vector Joystick.

#### Key Sync [Off, On]

The Key Sync parameter applies only to Vector Volume control. As described under “Vector Volume and CC control use separate EGs,” above, Vector CC control always acts as if Key Sync were Off.

**On (checked):** When Key Sync is **On**, the Vector Volume EG starts each time you press a key, and an independent EG runs for each note. This is the normal setting.

**Off (unchecked):** When Key Sync is **Off**, the Vector Volume EG starts from the phase determined by the first note in the phrase, so that the EGs for all notes being held are synchronized together.

#### Mode [Time, Tempo]

**Time:** When the Mode is set to **Time**, you can set the EG segment times in seconds or milliseconds.

**Tempo:** When the Mode is set to **Tempo**, the Vector EG will synchronize to the system tempo, as set by either the Tempo knob or MIDI Clock. Instead of using

seconds and milliseconds, you can specify the EG times as rhythmic values, using the Base Note and Multiplier parameters.

### 1-6b: Vector Envelope Loop

The Vector EG can loop between two points, and can continue to loop either for as long as you hold the note, or for a specified number of repeats. You can also turn the loop off completely, if you like.

#### Loop Type [0->3, 1->3, 2->3, 0<->3, 1<->3]

This selects the start and end points of the loop, and whether the loop is forwards only or forwards-backwards.

The first three selections, 0->3, 1->3, and 2->3, loop forwards only. For instance, when Loop Type is set to 1->3, the EG will play as follows: 0, 1, 2, 3, 1, 2, 3, 1, 2, 3 etc.

The last two selections, 0<->3 and 1<->3, are forwards-backwards. For instance, with the 1<->3 setting, the EG will play as follows: 0, 1, 2, 3, 2, 1, 2, 3 etc.

#### Loop Repeat [Off, 1...126, Inf]

**Off:** When this is set to Off, the EG will not loop at all.

**1-126:** The EG will loop the specified number of times, and then hold at point 3 until the note is released.

**Inf:** The EG will loop as long as the note is held, and then move to point 4 when the note is released.

### 1-6c: Vector Envelope

Like the Filter, Amp, and Pitch EGs, the Vector EG has a total of five points. Since the Vector EG can loop, however, the points are labeled differently; instead of names like attack and decay, they are simply numbered 0-4.

#### Sustain and Release

When the EG is in the middle of a loop, there is no "sustain" point per se. However, if the EG has already completed the specified number of **Loop Repeats**, or if **Loop Repeat** is Off, it will sustain at Point 3 until release.

At release, the EG always moves to Point 4.

#### Hold and Transition times

The Hold Time sets how long the EG lingers at each point, and the Transition time sets how long it takes to go from the selected point to the next.

For instance, the graphic below shows the succession of Hold and Transition times when the Loop Type is set to 1->3. For clarity, only the Y axis positions are shown.

Vector EG times, Loop Type = 1->3

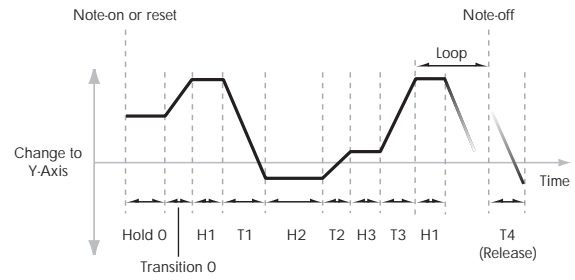

The transition from Point 3 into the loop always uses Point 3's Transition time, regardless of the Loop Type.

Points 0, 1, and 2's Transition times, however, work in reverse when moving backwards during a forwards-backwards loop. It's as if you were re-tracing the EG shape in reverse.

For instance, in the backwards section of a loop, moving from Point 2 to Point 1 uses Point 1's Transition time.

Forwards-Backwards Loop, Loop Type = 1<->3

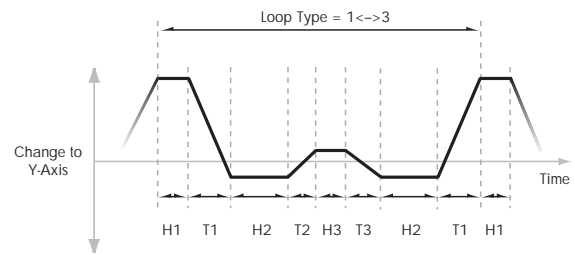

#### VJS

[Off, 0...4]

This horizontal row of radio buttons lets you edit the selected point's X-Y position using the Vector Joystick.

Just press the point's radio button, move the Vector Joystick to the desired location. When you're finished, press the Off radio button again.

When you are not editing the EG's X-Y positions, you should leave this set to Off, to avoid inadvertent changes to the EG.

#### Point 0

##### Position

In addition to editing the X and Y parameters with the standard data entry controls, you can also simply use the Vector Joystick to set the position, as described under "VJS," above.

##### X

[-127...+127]

This sets the point's position on the X axis.

##### Y

[-127...+127]

This sets the point's position on the Y axis.

##### Hold Time

This sets the length of time that the EG will stay on Point 0, before moving to Point 1. You can set the Hold Time in either seconds/milliseconds or rhythmic values, depending on the setting of the EG's Mode parameter.

**Time** [0ms...60sec]

This parameter lets you set the Hold Time in seconds and milliseconds. It applies only when the Mode is set to Time.

**(Base Note)** [Off, ♪ ... ◦ ]

This menu sets a basic rhythmic value for the **Hold Time**, relative to the system tempo. The values range from a 32nd note to a whole note, including triplets.

This parameter applies only when the **Mode** is set to **Tempo**.

**x (Multiply Base Note by...)** [01...32]

This multiplies the length of the **Base Note**. For instance, if the **Base Note** is set to a sixteenth note, and the multiplier is set to 3, the Hold Time will last for a dotted eighth note.

**Transition**

This sets the length of time that the EG takes to move from Point 0 to Point 1.

When the **Loop Type** is set to 0<->3, this also sets the time that it takes to move from Point 1 to Point 0 during the backwards section of the loop.

**Time** [0ms...60sec]

This parameter lets you set the Transition time in seconds and milliseconds. It applies only when the Mode is set to Time.

**(Base Note)** [♪ ... ◦ ]

This sets a basic rhythmic value for the **Hold Time**, relative to the system tempo. The values range from a 32nd note to a whole note, including triplets.

This parameter applies only when the **Mode** is set to **Tempo**.

**x (Multiply Base Note by...)** [01...32]

This multiplies the length of the **Base Note**. For instance, if the **Base Note** is set to a sixteenth note, and the multiplier is set to 3, the EG will move from Point 0 to Point 1 over a dotted eighth note.

**Points 1 and 2**

Points 1 and 2 work exactly like Point 0, as described above.

**Point 3**

Point 3 also works much like Points 0-2, with two main differences:

Point 3 always uses its own **Time** when moving into the loop, regardless of the direction of the loop.

If **Loop Repeat** is set to Off, or if the number is set between 1-126 and has already played the specified number of times, then the EG will stay at Point 3 until the EG either goes into release, or is reset by KARMA.

**Hold Time**

This works just like the **Hold Time** for Point 0, as described under "Hold Time" on page 51.

**Loop**

This sets the length of time that it takes to move from Point 3 to the first Point in the loop. You can set this in either seconds/milliseconds or rhythmic values, depending on whether the Mode is set to Time or Tempo.

The Time, Base Note, and Multiplier parameters work just like those for Point 0, as described under "Transition" on page 52.

**Point 4**

Point 4 is the Vector EG's release destination. Its time setting is different from those of the other Points.

Instead of setting the time it takes to move from Point 4 to the next Point, it sets how long it takes to go from the previous Point to Point 4.

The EG moves to Point 4 as soon as it releases, regardless of where it was before the release. For instance, let's say that the EG is in the middle of Point 2's Hold Time at note-off. The EG will immediately begin to move to Point 4, without waiting for the Hold Time to complete.

**Release**

This sets the length of time that it takes to move to Point 4 after note-off. You can set this in either seconds/milliseconds or rhythmic values, depending on whether the **Mode** is set to Time or Tempo.

The **Time**, **Base Note**, and **Multiplier** parameters work just like those for Point 0, as described under "Transition" on page 52.

**KARMA and Vector EG interaction**

KARMA can control the Vector EGs in various ways, as described below.

**CC Control EG**

When KARMA is **On**, it always starts and re-starts the CC Control EG, according to the KARMA trigger settings. This lets KARMA control sounds or effects in synchronization with the KARMA GE.

**Volume Control EGs**

When **Key Sync** is **Off**, and KARMA is **On**, KARMA will start and re-start the Volume Control EGs as well as the CC Control EG. This means that the resulting changes in oscillator volumes will be synchronized with the KARMA GE.

When **Key Sync** is **On**, KARMA does not affect Vector Volume Control. Each note will have its own, independent Volume Control EG, just as if KARMA was turned off.

**Entering the EG's release stage**

Assuming that KARMA is **On**:

When the **KARMA LATCH** switch is **Off**, the KARMA-controlled Vector EG(s) will start to release when you remove your hand from the keyboard (and when KARMA is no longer receiving any input notes from other sources).

When the **KARMA LATCH** switch is **On**, the KARMA-controlled Vector EG(s) will start to release only when **KARMA Latch** is turned **Off** again.

▼ 1–6: Page Menu Commands

The number before each command shows its ENTER + number-key shortcut. For more information on these shortcuts, see “ENTER + 0-9: shortcuts for menu commands” on page 147.

- 0: **Write Program.** For more information, see “Write Program” on page 147.

- 1: **Exclusive Solo.** For more information, see “Exclusive Solo” on page 147.
- 2: **Copy Oscillator.** For more information, see “Copy Oscillator” on page 153.
- 3: **Swap Oscillators.** For more information, see “Swap Oscillator” on page 153.
- 4: **Copy Vector Envelope.** For more information, see “Copy Vector Envelope” on page 153.

1–8: Set Up Controllers

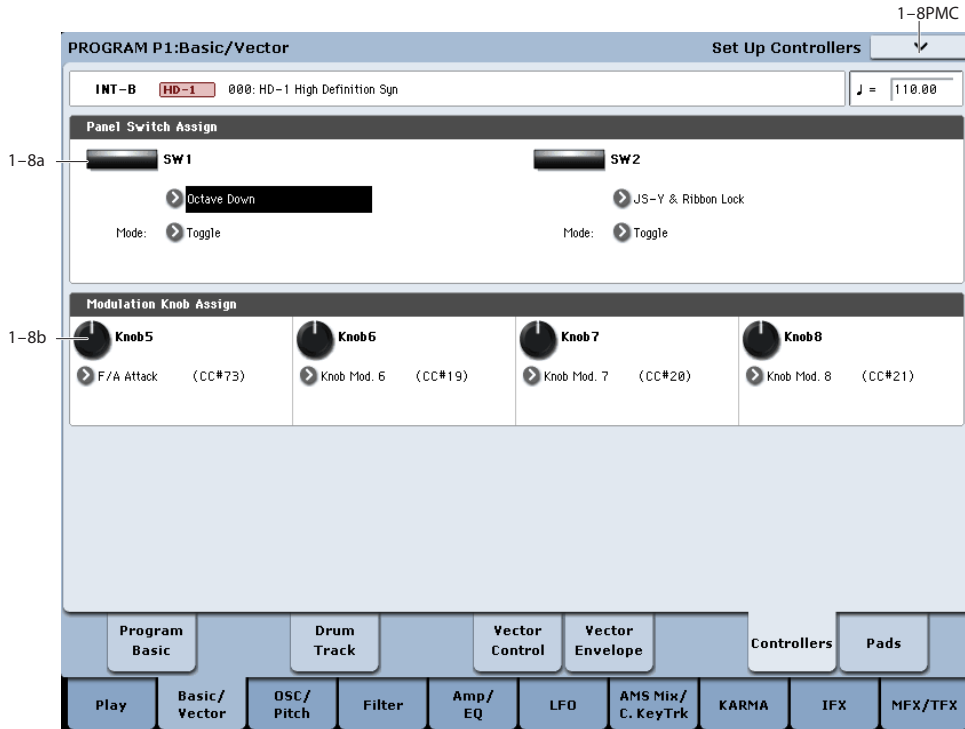

This page lets you set up the functionality of switches 1 and 2 (SW1/2) and Real-Time Knobs 5–8. These settings are made independently for each Program.

1–8a: Panel Switch Assign

These settings control the functionality of SW1 and SW2.

**SW1** [Off, ..., After Touch Lock]

This assigns a function to the SW1 switch. The on/off status can also be memorized. When you change the assignment, the switch is set to the Off condition.

For a complete list of the possible assignments, please see “SW1/2 Assignments” on page 1104.

**Mode** [Toggle, Momentary]

This specifies the mode of on/off when the SW1 switch is pressed.

**Toggle:** The state will alternate between On and Off each time you press the SW1 switch.

**Momentary:** The state will remain On only while you continue holding down the SW1 switch.

**SW2** [Off, ..., After Touch Lock]

**Mode** [Toggle, Momentary]

This assigns a function to SW2. The functions that you can assign to SW2 are the same as for SW1, with the exception that the SW1 switch’s SW1 Mod.:CC#80 assignment is replaced by SW2 Mod.:CC#81.

1–8b: Modulation Knob Assign

These settings assign functions (mainly MIDI control changes) to realtime modulation knobs 5–8. For a complete list of the possible assignments, please see “Realtime Knobs 5–8 Assignments” on page 1105.

**Knob 5** [Off, ..., MIDI CC#119]

**Knob 6** [Off, ..., MIDI CC#119]

**Knob 7** [Off, ..., MIDI CC#119]

**Knob 8** [Off, ..., MIDI CC#119]

## ▼ 1–8: Page Menu Commands

The number before each command shows its ENTER + number-key shortcut. For more information on these shortcuts, see “ENTER + 0-9: shortcuts for menu commands” on page 147.

- 0: **Write Program.** For more information, see “Write Program” on page 147.

- 1: **Exclusive Solo.** For more information, see “Exclusive Solo” on page 147.
- 2: **Copy Oscillator.** For more information, see “Copy Oscillator” on page 153.
- 3: **Swap Oscillators.** For more information, see “Swap Oscillator” on page 153.

## 1–9: Pads

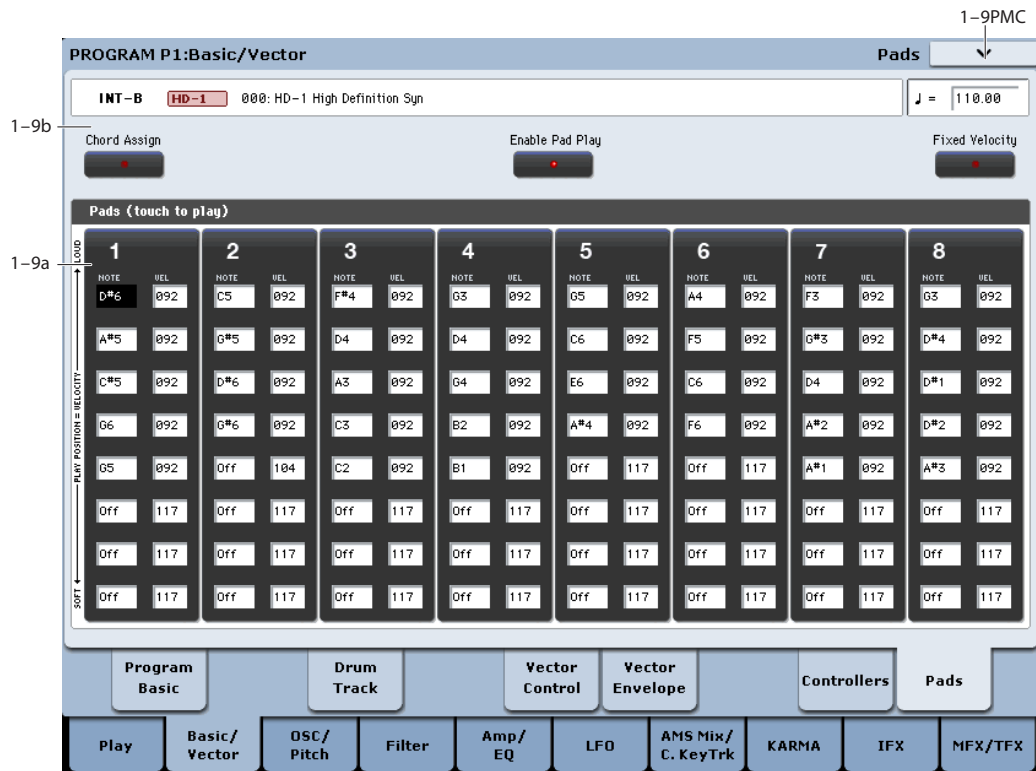

To avoid damaging the display, use care when playing the on-screen pads. Do not press strongly on the display or strike forcefully; instead, use a light and precise touch. “Velocity” is controlled by position, and not by force.

### Overview

This page features 8 virtual “pads,” which can be played by touching the screen, from MIDI input, or from compatible USB MIDI pad devices. You can use the pads for:

- Storing and selecting chords for Chord mode
- Selecting and triggering chords, especially for use with KARMA
- Playing drum sounds, especially in conjunction with a compatible USB MIDI pad device

The pads can play up to eight-note chords—and they even remember the velocities of the individual notes within the chord.

In addition to playing sounds directly, the pads are also used to select chords for Chord mode. For more information, see “Using Chord mode” on page 36 of the Operation Guide.

### Playing the pads

#### Playing the pads from the screen

You can play the pads directly from the screen. “Velocity” is controlled by where you touch the pad; lower is softer, and higher is louder. (You can also enable Fixed Velocity mode; see “Fixed Velocity” on page 55.)

If individual notes in the chord have different stored velocities, these are scaled by the overall velocity.

*Note:* from the screen, only one pad can be played at a time.

#### Playing the pads from MIDI or the keyboard

Pads can be triggered by incoming MIDI notes or CCs, or from the local keyboard. To do so:

1. Go to the **Global P2: Controllers** page.
2. Under **MIDI CC# Assign — Vector Joystick / Pads**, set **Pads 1-8** to the desired MIDI notes.

You can also use MIDI CCs, if you prefer. With CCs, the value of the CC is used as the pad’s “velocity.”

It’s as simple as that; the pads will now respond to the specified notes or CCs on the Global channel.

Be aware, however, that this will completely dedicate these notes to triggering the pads; they will no longer trigger sounds normally. For this reason, you may wish to assign notes either below or above the standard keyboard range (for instance, C-1 through G-1).

All of this also applies to notes played on the Global Channel from the local keyboard, with the same restriction: the assigned notes become dedicated to playing the pads.

### Playing the pads from Korg USB MIDI controllers

You can also play the pads using Korg USB MIDI controllers equipped with drum pads, including:

- nanoPAD and nanoPAD2
- microKONTROL
- padKONTROL
- KONTROL49

To use any of these Korg controllers, simply connect the controller to one of the KRONOS's two USB A ports. The KRONOS will automatically determine the MIDI assignments of the controller's pads 1-8, and map them directly to the KRONOS pads.

For more details, see "USB MIDI controllers" on page 1128.

---

## 1–9a: Pads

### Pad 1

**Notes 1...8** [Off, C–1...G9 / 001...127]

These parameters let you edit the 8 notes assigned to each pad, along with a separate velocity for each note. To play fewer than 8 notes, just set the unwanted notes to **Off**.

**Off:** Select this to disable the note.

**C–1...G9:** This sets the note number.

**001...127:** This sets the note's velocity value. For more information on pads and velocity, please see "Fixed Velocity," below.

### Assigning notes to the pads

You can assign notes to the pads directly from the keyboard, or enter notes and velocities manually. Regardless of how the notes were first assigned, you can edit their values here.

For more information, including step-by-step instructions and usage tips, see "Using the Chord Pads" on page 35 of the Operation Guide.

### Copying Pads

Just as you can assign notes to a pad by playing them on the keyboard, you can touch a pad to copy its assigned notes to another pad.

Simply touch the pad that you want to copy, and then touch the Chord Assign switch. Finally, touch the copy-destination pad; the assignments will be copied.

For more detailed instructions, please see "Using the Chord Pads" on page 35 of the Operation Guide.

### Pads 2...8

These are the same as for Pad 1, as described above.

---

## 1–9b: Control buttons

**Chord Assign** [Off, On]

This button lets you assign single notes and chords to the pads by playing on the keyboard. You can use this in two different ways, as described below.

### Play the notes, and then press Chord Assign

1. Play a single note, or a chord of up to 8 notes.
2. Press the Chord Assign button.
3. Press the pad to which you'd like to assign the notes.

That's it! The notes are now assigned to the pad.

### Press Chord Assign, and then play notes

This method lets you create a chord out of widely-spaced notes, even if you can't play all of the notes simultaneously.

1. Press the Chord Assign button.
2. Play a single note, or a chord of up to 8 notes.

You can play a single note, or a simple chord.

If you like, you can also play up to 8 notes as a legato phrase. As long as you take care that the notes overlap each other, the entire phrase will be recorded as a single chord. You can take as long as you like to play the phrase.

3. Touch the pad to which you'd like to assign the notes.

After pressing the pad, you're done!

**Enable Pad Play** [Off, On]

The pads play every time you touch within their boundaries. If you're editing the stored notes and velocities manually, you may wish to temporarily disable this feature. To do so:

1. Touch the Pad Play button at the top of the display, to turn it off.

The button's light will go dark, to show that it is disabled.

Once you're finished editing, turn it on again:

2. Touch the Pad Play button again, to turn it on.

The button's light will go on, to show that it is enabled.

*Note:* Enable Pad Play applies only to the on-screen pads, and does not affect pad triggering from MIDI, the local keyboard, or USB MIDI devices.

**Fixed Velocity** [Off, On]

Each pad stores a velocity level for each of its 8 notes. The **Fixed Velocity** button controls whether or not the pads respond to how hard you play. Its setting is stored with each Program, Combi, and Song.

When **Fixed Velocity** is on (LED lit), the pads always use their stored velocity settings.

When **Fixed Velocity** is off, the velocities are scaled according to how you play.

With the on-screen pads, touching the top of the pad produces the preset velocities. When you play towards the bottom of the pad, the preset velocities are scaled down accordingly, maintaining the balance between the notes in the chord.

With USB pads or MIDI input, the maximum input velocity (127) produces the preset velocities. When you play softer the preset velocities are scaled down accordingly, maintaining the balance between the notes in the chord.

---

### ▼ 1–9: Page Menu Commands

The number before each command shows its ENTER + number-key shortcut. For more information on these shortcuts, see “ENTER + 0-9: shortcuts for menu commands” on page 147.

- 0: **Write Program**. For more information, see “Write Program” on page 147.
- 1: **Exclusive Solo**. For more information, see “Exclusive Solo” on page 147.
- 2: **Copy Oscillator**. For more information, see “Copy Oscillator” on page 153.
- 3: **Swap Oscillators**. For more information, see “Swap Oscillator” on page 153.
- 4: **Copy Pad Setup**. For more information, see “Copy Pad Setup” on page 154.



## Program P2: OSC/Pitch

These pages control the first and most basic elements of HD-1's sounds: the Multisamples that the oscillators play, and the pitch at which it plays them. For instance, you can:

- Select Multisamples and Wave Sequences for Single and Double Programs, or Drum Kits for Drum Programs.
- Set up velocity splits, crossfades, and layers for Single and Double Programs.

- Set the basic pitch of the sound, including the octave, fine tuning, and so on.
- Control pitch modulation from a wide variety of sources, such as JSX, the ribbon, LFOs, and the Pitch EG.

Note that when the **Oscillator Mode** is set to **Single** or **Drums**, only Oscillator 1's filters are active; the pages for Oscillator 2's filters will be grayed out.

### 2-1: OSC1 Basic

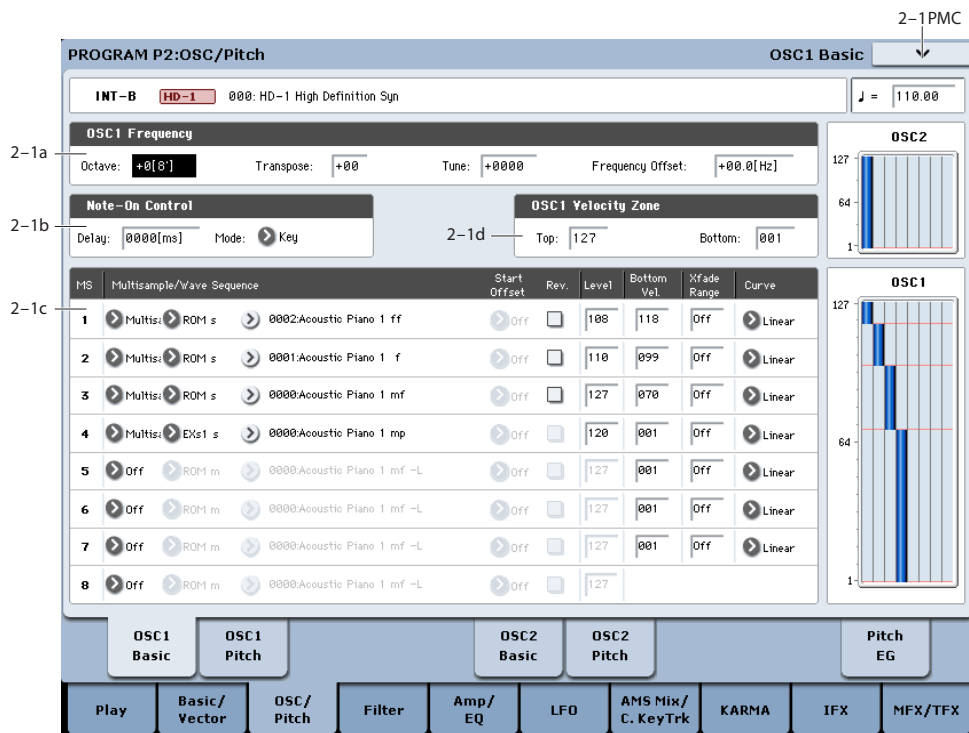

HD-1's sounds are based on samples, and this page lets you set up all of the basic sample-related settings. Among other things, you can:

- Select Multisamples and/or Wave Sequences for the Oscillator (in a Single or Double Program), or select the Drum Kit for a Drum Program
- Set the Oscillator's basic pitch
- Create velocity splits and crossfades between Multisamples and/or Wave Sequences

#### 2-1a: OSC1 Frequency

**Octave** [-2[32'], -1[16'], +0[8'], +1[4']]

This sets the basic pitch of the Oscillator, in octaves. The default is +0[8']. The standard octave of a multisample is +0 [8'].

**Transpose** [-12...+12]

This adjusts the pitch in semitones, over a range of ±1 octave.

**Tune** [-1200...+1200]

This adjusts the pitch in cents, over a range of ±1 octave. A cent is 1/100 of a semitone.

**Frequency Offset** [-10.0Hz ... +10.0Hz]

This adjusts the pitch by increments of 0.1 Hz. **Frequency Offset** is different from **Tune** in that, when used to detune the two oscillators, it can create a constant beat frequency across the range of the keyboard.

#### 2-1b: Note-On Control

**Delay** [0000ms...5000ms, KeyOff]

Use this to create a delay between the time that you press a key, and the time that the note actually sounds.

This is most useful in Double Programs, for delaying one oscillator in relation to the other.

**KeyOff** is a special setting. Instead of delaying the sound by a particular amount of time, the sound will play as soon as you release the key. You can use this to create the “click” heard when a harpsichord note is released, for instance.

In general, when you use the **KeyOff** setting, it’s also best to set the oscillator’s **Amp EG Sustain Level** to 0.

**Mode** [Key, Key + Damper]

Normally, you play notes simply by pressing keys on the keyboard. In special cases, however, you can set this parameter so that you must first be holding down the damper pedal, and then press a key, in order to play a note. For instance, this can be useful when modeling the behavior of a piano soundboard.

**Key** is the normal mode.

When you select **Key + Damper**, notes will only sound if the damper pedal is being held down. When the damper pedal is released, all notes will be stopped—even if they are still being held down.

---

## 2-1c: OSC1 Multisample/Wave Sequence

The parameters in this section will change depending on the setting of the **Oscillator Mode** parameter.

In Single and Double modes, each Oscillator can play up to four Multisamples or Wave Sequences. In Drum mode, there is one Oscillator, and it plays a single Drum Kit.

### Multisamples, Wave Sequences, and Drum Kits

Multisamples, Drum Kits, and Wave Sequences allow you to play samples in different ways.

- Multisamples lay out one or more samples across the keyboard. For instance, a very simple guitar Multisample might have six samples—one for each string.
- Wave Sequences play back a series of different Multisamples over time. These Multisamples may crossfade to create smooth, evolving timbres, or change abruptly to create rhythms.
- As the name suggests, Drum Kits are optimized for playing drum samples.

### Velocity splits, crossfades, and layers

As mentioned above, unless you’re in Drum mode, each Oscillator has eight velocity zones, named MS1 (High) through MS8 (Low). Each of these zones can play either a Multisample or a Wave Sequence, and has separate settings for Level, Start Offset, and so on.

Each of the zones can fade into the next, to create smoother velocity transitions. Zones can even be layered together, two at a time.

### MS1 (High)

These are the settings for the first and highest velocity zone.

If you want to create a simple setup with only a single Multisample or Wave Sequence, just set up MS1 as desired, and then set the **Bottom Velocity** to 1 and the **Xfade Range** to 0.

### Type [Off, Multisample, Wave Sequence]

This selects whether MS1 will play a Multisample, a Wave Sequence, or nothing at all.

The Type selection affects the choices shown in the Bank and Multisample menus.

### Bank (Multisample) [List of Multisample Banks]

This menu will appear only if the **Type** is set to Multisample.

There are four types of Multisample Banks: **ROM, Sampling Mode, EXs**, and **User Sample Banks**. For each type, you can also choose between looking at mono and stereo Multisamples. Note that stereo Multisamples will require twice as many voices as mono Multisamples.

**ROM** Multisamples are the built-in “factory” sounds, and are always available.

**Smp (Sampling Mode)** Multisamples are the ones that you can see and edit in Sampling Mode. These may include Akai, SoundFont 2.0, AIFF or WAV files loaded from disk, or native KRONOS samples (including third-party sound libraries and samples that you create yourself). Anything that can be used in Sampling Mode can also be loaded as a User Sample Bank.

After the abbreviation “Smp,” several different things may appear, as described below.

**Smp: Old RAM** provides compatibility with older KRONOS sounds; it will appear in old Programs which used “RAM” samples, but cannot be selected for new Programs. Instead of pointing to a specific User Sample Bank, it will use whatever Multisample data is loaded into Sampling Mode. This ensures that older Programs and sample data will continue to work as they did previously. Updating to the new format is easy; for more information, see “Converting older sounds” on page 155 of the Operation Guide.

**Smp: New Sampling Session** will appear when there’s data in Sampling Mode which hasn’t yet been saved to disk as a User Sample Bank. For instance, this might happen if you’ve loaded an old KSC file, loaded individual Samples or Multisamples, or recorded some new samples. Once the KSC is saved to disk, the name will update to show the file path (as described below).

**Smp: [file name]** will appear when a User Sample Bank has been loaded into Sampling Mode. The name is the file name itself along with those of all its enclosing folders.

**EXs** Multisample banks are PCM expansion sets created especially for the KRONOS. Each has its own unique number; for instance, the ROM Expansion is EXs1, and the Concert Grand Piano expansion is EXs2. Only the currently loaded EXs banks will appear on this menu.

**User Sample Banks** bring the benefits of EXs to your own sample libraries. You can load and play gigabytes of your custom or converted samples at once, using Virtual Memory. The name is shown as a path to the KSC file, including the file name and the names of all enclosing directories. Only the currently loaded User Sample Banks will appear in this menu.

If a sound refers to a User Sample Bank which is not on the internal drive(s), the name will appear as “Unknown Sample Bank [number]” when the bank select dialog is open, shortened to “??[number]” when the dialog is closed.

For more information, see “User Sample Banks” on page 154 of the Operation Guide.

**Bank (Wave Sequence) [INT, U-A...G, U-AA...GG]**

This menu will appear if the **Type** is set to Wave Sequence.

INT Wave Sequences are the built-in “factory” sounds. You can over-write them if you wish, but doing so may change the sounds of the Programs and Combis in Banks INT A-E.

U-A through U-GG are user banks, for storing sounds that you create yourself, optional sound banks from Korg, or third-party sound libraries.

**Multisample/Wave Sequence Select [List]**

This parameter lets you select a Multisample or Wave Sequence, depending on the **Type** setting.

Some Multisamples may have an upper limit to their keyboard range, over which they may not produce any sound.

To select a Multisample or Wave Sequence:

1. Press the Multisample/Wave Sequence Select popup button to open the menu.

Within the window, ROM Multisamples are organized by categories; Wave Sequences are organized by bank; and EXs, User Sample Bank, and Sampling Mode Multisamples appear as a continuous list.

2. For ROM Multisamples or Wave Sequences, use the tabs to select a category or bank.
3. Select a Multisample or Wave Sequence from the list.
4. Press the OK button to confirm your selection, or press the Cancel button to exit without making a change.

Note: if the stored selection uses EXs, User Sample Bank, and Sampling Mode data which is not currently loaded, it will not make any sound. As an indication of this, the name will be shown in red. The message “Samples Not Loaded” will also appear at the top of the display. To fix this, load the required sample data.

**Mono and Stereo Multisample lists for ROM and EXs**

If ROM mono or any EXs mono Bank is selected, the list shows all of the mono Multisamples in the Bank. If the Bank contains stereo Multisamples, you’ll also see the left and right channels as separate, mono Multisamples, with -L and -R appended to the end of the name.

If ROM Stereo or any EXs Stereo Bank is selected, only stereo multisamples will be shown.

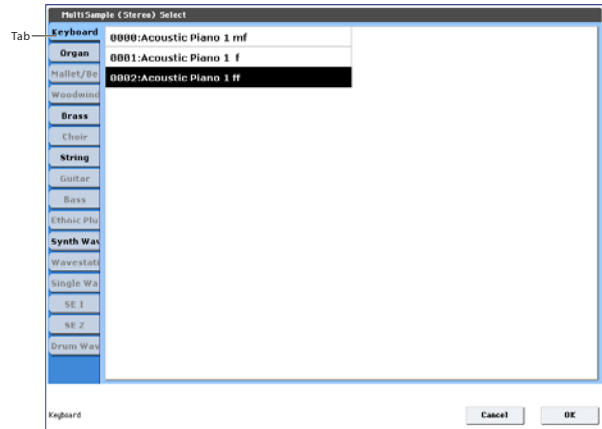

**Mono and Stereo Multisample lists for Sampling Mode and User Sample Banks**

If Sampling Mode mono or any mono User Sample Bank is selected, the list shows all of the mono Multisamples in the Bank. If the Bank contains stereo Multisamples, you’ll also see the left and right channels as separate, mono Multisamples, with -L and -R appended to the end of the name.

If Sampling Mode stereo or any stereo User Sample Bank is selected, only the stereo Multisamples will appear. However, they will still be listed as separate left and right Multisamples. Selecting either the left or right channels will select the stereo pair.

**Wave Sequence Select menu**

Use the tabs to select a bank, and then select a Wave Sequence. Press the OK button to confirm your selection, or press the Cancel button to revert to the previous setting.

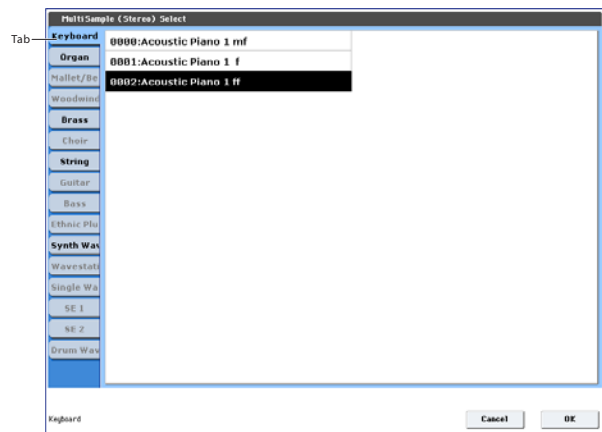

**Reverse [Off, On]**

This lets you play the selected multisample backwards, without looping. **Reverse** applies only to Multisamples; when the **Type** is set Wave Sequence, this is grayed out.

Note: If the individual samples within a Multisample are already set to Reverse, they will still play in reverse, regardless of this setting.

*Note:* Reverse is not available for EXs or User Sample Bank Multisamples loaded using Virtual Memory. To use reverse with this data, set the Load Method to RAM. For more information, see “Change load method” on page 766.

**On (checked):** The Multisample will play back in reverse.

**Off (unchecked):** The Multisample will play back normally.

**Level [0...127]**

This sets the basic volume level of the multisample. The Amp section can modify this basic level extensively with envelopes, LFOs, keyboard tracking, and other modulation; for more information, see “Program P4: Amp/EQ,” on page 82.

⚠ Depending on the multisample, high **Level** settings may cause distortion when playing many notes at a time. If this occurs, lower the **Level**.

With Sampling Mode Multisamples, each Sample also has a **+12dB** option, configured in Sampling Mode. If this is turned on, the Sample will play back approximately 12dB louder. For more information, see “+12dB” on page 701.

**Start Offset [Off, 1st...8th]**

In addition to simply starting playback from the beginning, ROM and EXs Multisamples can have up to 8 different pre-programmed alternate starting points.

Similarly, Sampling Mode and User Sample Bank Multisamples can play either from the beginning of the waveform, or from the loop start point.

**Start Offset** applies only to Multisamples; when the **Type** is set Wave Sequence, this is grayed out.

**Start Offsets: ROM and EXs**

With ROM and EXs Multisamples, the Start Offset specifies whether to use the normal start point (**Off**), or to use one of the alternate start points (**1st–8th**).

Some ROM and EXs Multisamples may have fewer than 8 pre-programmed points, in which case only the available points can be selected.

**Start Offsets: Sampling Mode and User Sample Banks**

With Sampling Mode and User Sample Bank Multisamples, only **Off** and **1st** are available. **Off** uses the normal start point, and **1st** uses the loop start instead. **2nd** through **8th** will be grayed out.

**Bottom Velocity [1...127]**

This sets the lowest velocity at which the Multisample or Wave Sequence will sound. MS1’s Bottom Velocity can be equal to, but not lower than, than that of MS2.

**Xfade Range [Off, 1...127]**

This sets the range of velocities over which MS1 will fade into MS2, going up from the Bottom Velocity.

For instance, if the Bottom Velocity is set to 64, and the Xfade Range is set to 20, MS2 will start to fade in at velocities of 84 and below.

When velocities are within the Xfade Range, the Oscillator will use twice as much polyphony as it would normally.

*Note:* You can only fade between two zones at once.

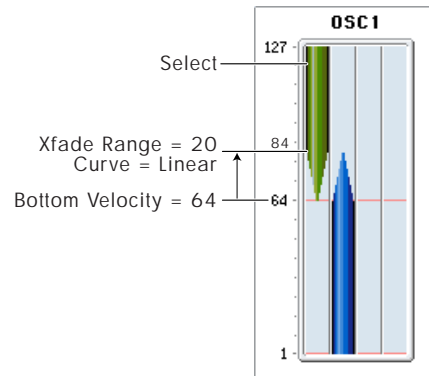

**Curve [Linear, Power, Layer]**

This controls the volume curve of the crossfade. **Linear** and **Power** (short for Equal Power) let you fine-tune the way that the two Multisamples mix together; one or the other may be more appropriate for a given pair of Multisamples. **Layer**, true to its name, lets you layer the two Multisamples together without any crossfading.

*Crossfade Curves*

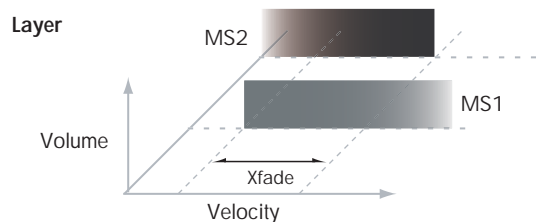
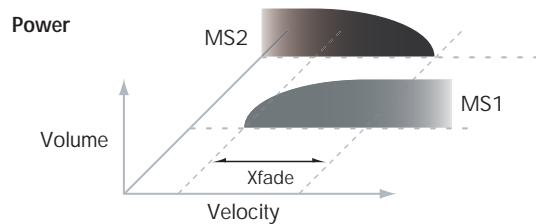
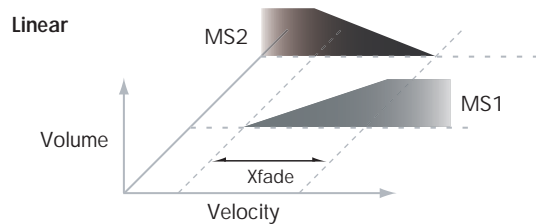

**Linear** means that the two samples will each be at 50% of their full volume in the middle of the crossfade. Sometimes, this may create a dip in the volume level; if so, try using **Power** instead.

**Power**, short for Equal Power, means that the two samples will each be at around 70% of their full volume in the middle of the crossfade. Sometimes, this may create a bump in the volume level, in which case you might try selecting **Linear** instead.

**Layer** means that the two Multisamples will be layered together, both at full volume, for the entire range of the crossfade.

**MS2...7 and MS8 (Low)**

These are the settings for the remaining velocity zones. The parameters for MS2...7 are exactly the same as those for “MS1 (High),” above.

The parameters for MS8 (Low) are also similar to those for MS1, except that MS8 has no settings for Bottom Velocity (which is always fixed at 1), Xfade Range, or Curve.

**2-1d: OSC 1 Velocity Zone**

In addition to setting the velocity zones for each of the four Multisamples in a single Oscillator, you can also set high and low velocities for each of the two Oscillators as a whole.

OSC1 Basic - Drum Kit

These velocity zones take precedence over the velocity settings for the individual MS1-4.

**Top** [001...127]

This sets the highest velocity at which the Oscillator will sound.

*Note:* The Top velocity must be greater than the Bottom velocity.

**Bottom** [001...127]

This sets the lowest velocity at which the Oscillator will sound.

**Entering velocity values from the keyboard**

You can enter velocity values directly by playing them on the keyboard. To do so:

1. Select one of the Key parameters.
2. Hold down the ENTER key.
3. While holding ENTER, play a note on the keyboard at the desired velocity.

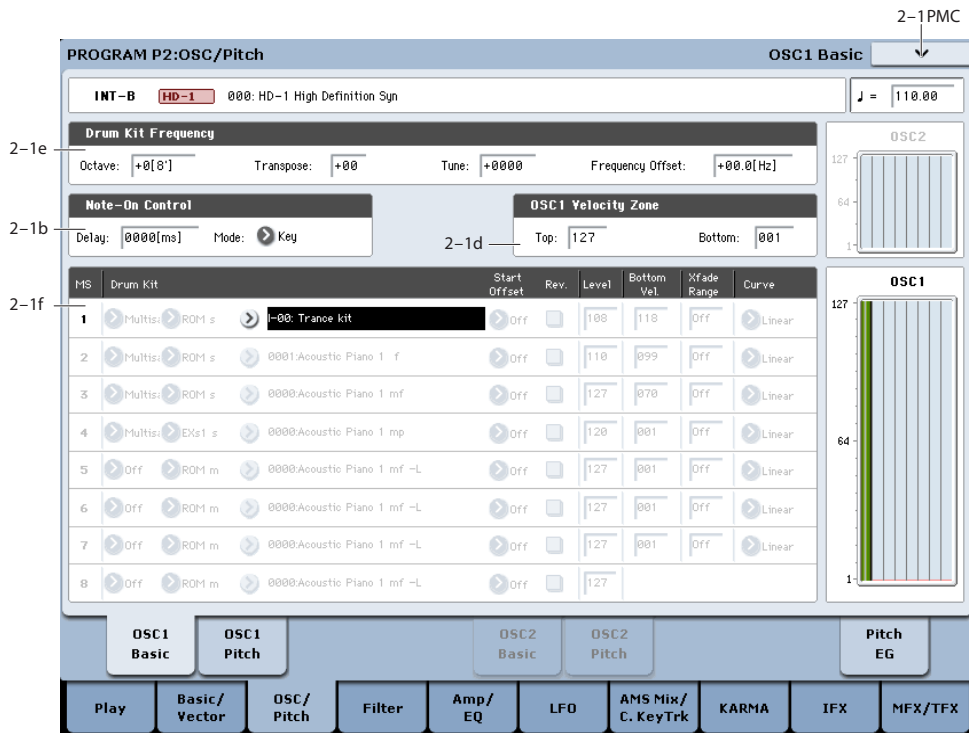

These parameters appear when the Oscillator Mode is set to Drum Kit.

**2-1e: Drum Kit Frequency**

**Octave** [-2[32'], -1[16'], +0[8'], +1[4']]

This adjusts the pitch in octave units. When using a drum kit, set the Octave to 8'.

⚠ When editing a drum program, you must set this parameter to 8'. With other settings, the sounds of the drum kit will be assigned to the wrong notes of the keyboard.

**Transpose** [-12...+12]

This adjusts the location of the instruments in the selected drum kit. Unless you need to change this, leave it at 0.

**Tune** [-1200...+1200]

This adjusts the pitch in one-cent units.

The pitch of each drum kit can be adjusted in Global P5: Drum kit.

**Delay [0ms...5000ms, KeyOff]**

Use this to create a delay between the time that you press a key, and the time that the note actually sounds.

**KeyOff** is a special setting. Instead of delaying the sound by a particular amount of time, the sound will play as soon as you release the key.

In general, when you use the **KeyOff** setting, it's also best to set the oscillator's Amp EG **Sustain Level** to 0.

**2-1f: Drum Kit**

**Drum Kit [I-00...39, U-A...G 00...15, GM0...8, U-AA...GG 00...15]**

This selects a drum kit for the Oscillator. Drum Kits allow each note to have up to 8 different velocity-crossfaded Drum Samples, along with per-note settings for volume, pan, effects routing, and more.

Drum Kits are edited in Global mode. For more information, see "Global P5: Drum Kit" on page 796 and "Using Drum Kits" on page 176 of the Operation Guide.

**▼ 2-1: Page Menu Commands**

The number before each command shows its ENTER + number-key shortcut. For more information on these shortcuts, see "ENTER + 0-9: shortcuts for menu commands" on page 147.

- 0: **Write Program**. For more information, see "Write Program" on page 147.
- 1: **Exclusive Solo**. For more information, see "Exclusive Solo" on page 147.
- 2: **Copy Oscillator**. For more information, see "Copy Oscillator" on page 153.
- 3: **Swap Oscillators**. For more information, see "Swap Oscillator" on page 153.
- 4: **Sample Parameters**. For more information, see "Sample Parameters" on page 154.
- 5: **Remap MS/Sample Banks**. For more information, see "Remap MS/Sample Banks" on page 163.

**2-2: OSC1 Pitch**

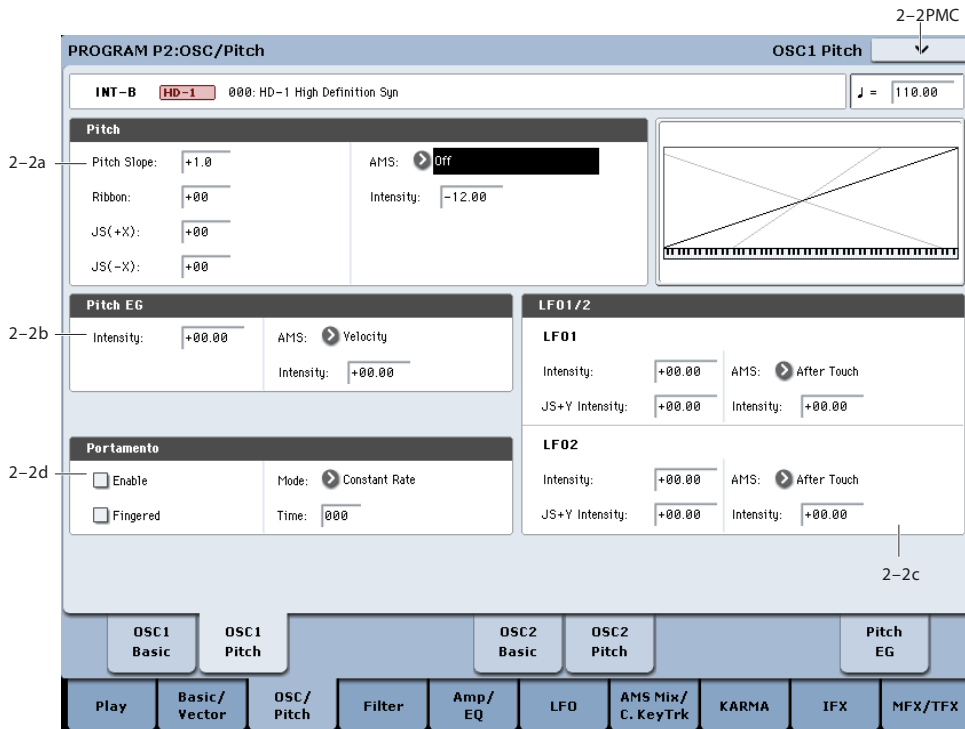

This page contains all of the settings for Oscillator 1's pitch modulation. For example, you can:

- Set up pitch bend from both Joystick X (with separate settings for bending up and bending down) and the ribbon controller.
- Use Pitch Slope to control how the pitch changes when you play up and down the keyboard.
- Set up Portamento.

- Assign AMS modulation for pitch.
- Set up initial amounts of pitch modulation from the Pitch EG and LFO1/2, as well as AMS modulation of LFO and EG amounts.



## 2-2a: Pitch

### Pitch Slope [-1.0...+2.0]

Normally, this should be set to the default of +1.0.

**Positive (+)** values cause the pitch to rise as you play higher on the keyboard, and **negative (-)** values cause the pitch to *fall* as you play higher on the keyboard.

When this is set to **0**, playing different notes on the keyboard won't change the pitch at all; it will be as if you're always playing C4. This can be useful for special effects sounds, for instance.

*Pitch Slope, pitch, and note*

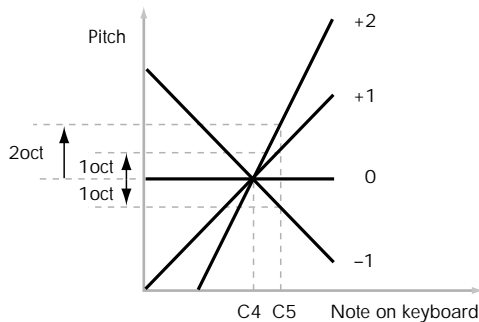

### Ribbon [-12...+12]

You can use the ribbon controller for pitch-bend. This parameter sets the range of the ribbon's pitch-bend, in semitones.

**Positive (+)** values make the pitch rise when you press the ribbon controller to the right of center, and **negative (-)** values will cause the pitch to fall.

For example, with a setting of **+12**, pressing the far right edge of the ribbon controller will raise the pitch one octave, and pressing the far left edge will lower the pitch by one octave.

With a setting of **-12**, the effect is reversed; pressing on the right edge will *lower* the pitch, and pressing on the left will *raise* the pitch.

When you lift off of the ribbon, the pitch will snap back to the center (unless you're using the SW1/2 "Ribbon Lock" feature). So, by tapping on the right edge of the ribbon and then releasing quickly, you can create guitar "hammer-on" effects.

### JS (+X) [-60...+12]

This sets the maximum amount of pitch bend, in semitones, when you move the joystick to the right. For normal pitch bend, set this to a positive value.

For example, if you set this to **+12** and move the joystick all the way to the right, the pitch will rise one octave above the original pitch.

### JS (-X) [-60...+12]

This sets the maximum amount of pitch bend, in semitones, when you move the joystick to the left. For normal pitch bend, set this to a negative value.

For example, if you set this to **-60** and move the joystick all the way to the left, the pitch will fall five octaves below the original pitch. You can use this to create guitar-style downward swoops.

### AMS (Pitch)

[List of AMS Sources]

This selects a modulation source to control the pitch. For a list of AMS sources, see "Alternate Modulation Source (AMS) List" on page 1091.

### Intensity [-12.00...+12.00]

This controls the depth and direction of the pitch modulation, in semitones.

For example if you set **AMS** to **After Touch** and then press down on the keyboard, the pitch will rise if this parameter is set to a **positive (+)** value, or fall if this parameter is set to a **negative (-)** value.

## 2-2b: Pitch EG

### Intensity [-12.00...+12.00]

This controls the initial effect of the Pitch EG on Oscillators 1's frequency, in half-steps, before any AMS modulation.

The Pitch EG's shape can swing all the way from +99 to -99. When the Intensity is set to a **positive (+)** value, positive values from the EG raise the pitch, and negative values lower the pitch.

When the Intensity is set to a **negative (-)** value, the effect of the EG is reversed; positive EG values mean *lower* pitches, and negative EG values mean *higher* pitches.

### AMS (Pitch EG) [List of AMS Sources]

This selects any AMS modulation source to scale the amount of the Pitch EG applied to the pitch.

For a list of AMS sources, see "Alternate Modulation Source (AMS) List" on page 1091.

### Intensity [-12.00...+12.00]

This controls the depth and direction of the pitch EG AMS modulation. The AMS modulation and the initial Intensity are added together to determine the Pitch EG's final effect.

With **positive (+) values**, greater modulation will increase the effect of the Pitch EG, as shown in example **B** below.

*Pitch EG AMS*

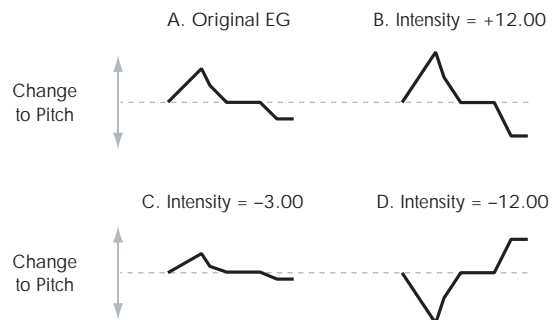

With **negative (-) values**, greater modulation will introduce the *opposite* effect of the Pitch EG-like inverting the polarity of the envelope. You can use this in several different ways:

- You can set an initial positive amount with the Intensity parameter, and then reduce this amount with AMS. In this case, the final effect of the EG is



simply diminished, and not actually inverted, as shown in example C.

- You can also set the AMS Intensity amount to be greater than the initial Intensity. In this case, the EG will have a positive effect with low modulation amounts, and an inverted effect at higher modulation amounts—as shown in example D.

---

## 2-2c: LFO1/2

LFO1 and LFO2 can both modulate the pitch. You can control the strength of each LFO's modulation in three different ways:

- Set an initial amount of LFO modulation, using the LFO 1/2 Intensity parameters.
- Use JS+Y to scale the amount of the LFO.
- Use any AMS source to scale the amount the LFO.

You can use each of these methods for each of the two LFOs. The results are added together to produce the total LFO effect.

### LFO1

#### LFO1 Intensity [-12.00...+12.00]

This controls the initial effect of the LFO on the pitch, in semitones, before any JS+Y or AMS modulation.

Negative (–) settings will invert the phase of the LFO.

#### JS+Y Intensity (LFO1 JS+Y Int.) [-12.00...+12.00]

Moving the joystick “up” from the center detent position, away from yourself, produces the JS+Y controller. You can use this to scale the amount of the LFO applied to the pitch. This parameter sets the maximum amount of LFO modulation added by JS+Y, in semitones.

As this value is **increased**, moving the joystick in the +Y direction will cause the OSC1 LFO1 to produce deeper pitch modulation.

Negative (–) settings will invert the phase of the LFO. You can also use this to reduce the initial amount of the LFO, as set by **LFO1 Intensity**, above. For example:

#### 1. Set LFO1 Intensity to +7.00.

The LFO will now have a fairly strong effect on the pitch, bending it by a perfect 5th.

#### 2. Set JS+Y Intensity to –7.00.

Now, if you move the joystick up, the effect of the LFO will fade away. When the joystick is all the way at the top of its range, the LFO will be completely cancelled out.

#### AMS (LFO1) [List of AMS Sources]

This selects any AMS modulation source to scale the amount of the LFO applied to pitch.

For a list of AMS sources, see “Alternate Modulation Source (AMS) List” on page 1091.

#### Intensity [-12.00...+12.00]

This controls the depth and direction of the LFO AMS modulation for pitch.

For example, if **AMS** is set to **After Touch**, **positive** settings mean that aftertouch will increase the amount of pitch modulation from LFO1.

### LFO2

The parameters for LFO2 are identical to those for LFO1. For more information, see the descriptions under LFO1, above.

---

## 2-2d: Portamento

Portamento lets the pitch glide smoothly between notes, instead of changing abruptly.

#### Enable [Off, On]

**On (checked):** Turns on Portamento, so that pitch glides smoothly between notes.

**Off (unchecked):** Turns off Portamento. This is the default state.

#### Fingered [Off, On]

This parameter allows you to control Portamento through your playing style. When it's enabled, playing legato will turn on Portamento, and playing detached will turn it off again.

This option is only available when Portamento Enable is turned on.

**On (checked):** Turns on Fingered Portamento.

**Off (unchecked):** Turns off Fingered Portamento.

#### Mode [Constant Rate, Constant Time]

Constant Rate means that Portamento will always take the same amount of time to glide a given distance in pitch - for instance, one second per octave. Put another way, gliding several octaves will take much longer than gliding a half-step.

Constant Time means that Portamento will always take the same amount of time to glide from one note to another, regardless of the difference in pitch. This is especially useful when playing chords, since it ensures that each note in the chord will end its glide at the same time.

#### Time [000...127]

This controls the portamento time. Higher values mean longer times, for slower changes in pitch.

This option is only available when Portamento Enable is turned on.

#### Assigning SW1 or SW2 to Portamento On/Off

You can use the two assignable switches, SW1 and SW2, to turn portamento on and off.

To do so:

1. Go to the Program P1–Set Up Controllers page.
2. Under Panel Switch Assign, set either SW1 or SW2 to Portamento SW (CC#65).

Now, the selected switch will enable and disable Portamento. It will also send the MIDI Portamento controller, CC#65.

 Even if you don't assign SW1/2 to Portamento, you can still use MIDI Controller #65 to turn Portamento on and off.

## ▼ 2-2: Page Menu Commands

The number before each command shows its ENTER + number-key shortcut. For more information on these shortcuts, see “ENTER + 0-9: shortcuts for menu commands” on page 147.

- 0: **Write Program.** For more information, see “Write Program” on page 147.

- 1: **Exclusive Solo.** For more information, see “Exclusive Solo” on page 147.
- 2: **Copy Oscillator.** For more information, see “Copy Oscillator” on page 153.
- 3: **Swap Oscillators.** For more information, see “Swap Oscillator” on page 153.

## 2-5: OSC2 Basic

This page controls the basic settings for Oscillator 2. It is available only when the **Oscillator Mode** is set to **Double**; if not, the page will be grayed out.

The parameters are identical to those for Oscillator 1, as described under “2-1: OSC1 Basic,” on page 57.

## 2-6: OSC2 Pitch

This page controls the pitch settings for Oscillator 2. It is available only when the **Oscillator Mode** is set to **Double**; if not, the page will be grayed out.

The parameters are identical to those for Oscillator 1, as described under “2-2: OSC1 Pitch,” on page 62.

## 2-9: Pitch EG AMSSource

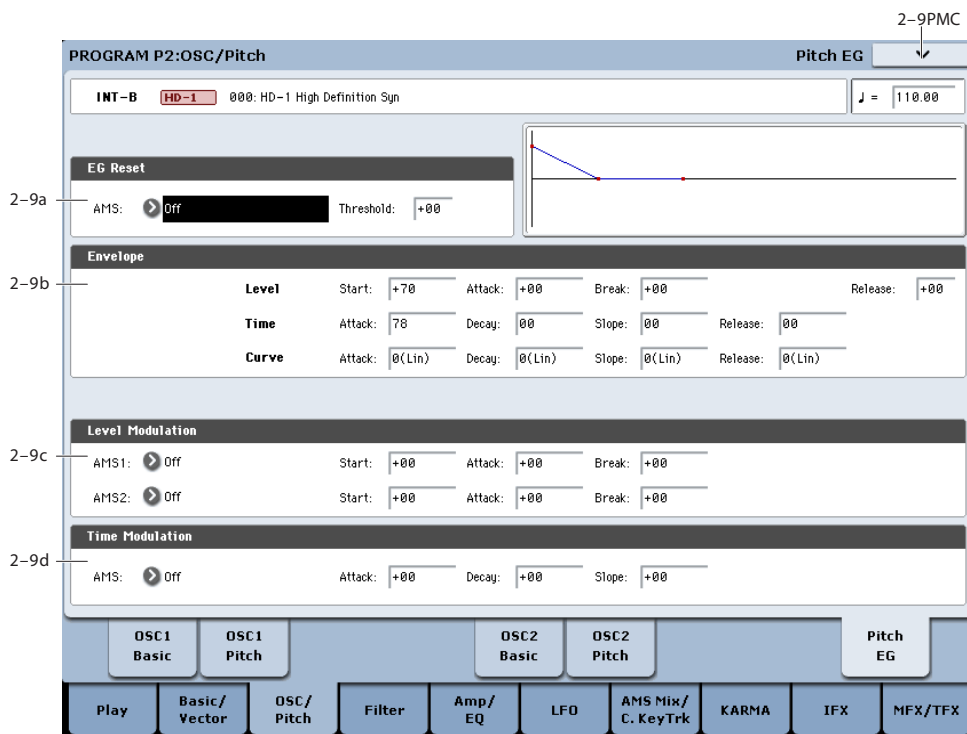

The Pitch EG, or Envelope Generator, lets you create complex, time-varying changes to the pitch of Oscillators 1 and 2. The parameters on this page control the shape of the EG. For instance, you can:

- Create the basic EG shape by setting the levels and times of each segment.
- Control the curvature of each EG segment, for subtle control over the sound of the EG.
- Set up complex modulation of EG levels and times.
- Set up an AMS source, such as an LFO, to restart the EG.

To control how much effect the EG has on the pitch, use the Pitch EG parameters on the Pitch Mod page, as described under “2-2b: Pitch EG,” on page 63.

### Differences from the other EGs

The Pitch EG is different from the Filter and Amp EGs in several ways:

- The single Pitch EG is shared by both Oscillator 1 and Oscillator 2.
- The Sustain level is always 0.

- The Level modulation has two AMS sources instead of one, and the Time modulation has one AMS source instead of three.

**Pitch EG is also an AMS source**

You can use the Pitch EG as an AMS source to modulate other parameters, just like the keyboard tracking and LFOs. Simply select the Pitch EG in the AMS list for the desired parameter.

**2-9a: EG Reset**

**AMS (EG Reset AMS) [List of AMS Sources]**

This selects an AMS source to reset the EG to the start point. For instance, you can use a tempo-synced LFO to trigger the EG in a repeating rhythm. This reset is in addition to the initial note-on, which always causes the EG to start.

For a list of AMS sources, see “Alternate Modulation Source (AMS) List” on page 1091.

**Threshold [-99...+99]**

This sets the AMS level which will trigger the EG reset. Among other things, you can use this to adjust the exact point in an LFO’s phase at which the EG will be reset, effectively controlling its “groove” against other rhythmic effects.

When the threshold is **positive**, the EG triggers when passing through the threshold moving upwards. When the threshold is **negative**, the EG triggers when passing through the threshold moving downwards.

**Note:** with some LFO shapes, and with faster LFO speeds, the LFO may not always reach the extreme values of +99 or -99. In this case, setting the **Threshold** to these values may cause inconsistent behavior, or may mean that the EG doesn’t reset at all. If this happens, reduce the **Threshold** until the EG triggers consistently.

**2-9b: Envelope**

*Pitch EG*

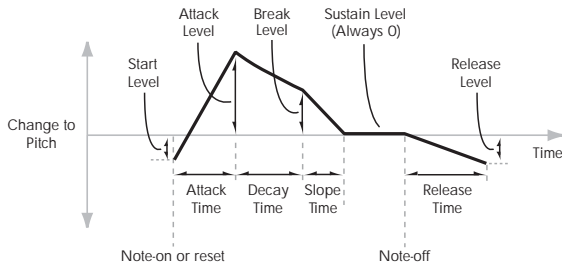

An envelope creates a modulation signal by moving from one level to another over a specified time, and then moving to another level over another period of time, and so on.

The parameters below let you set four levels, the amount of time it takes to go from each of the levels to the next, and the shape (from linear to curved) of each transition.

**Level**

Each of the four levels can be either positive or negative.

**Positive** levels will make the pitch (or other AMS destination) go up from its programmed value; **negative** levels will make it go down.

Note that, unlike the Filter and Amp EGs, the Pitch EG’s Sustain Level is always 0.

**Start [-99...+99]**

This sets the initial EG level, at note-on.

**Attack [-99...+99]**

This sets the level at the end of the Attack time.

**Break [99...+99]**

Break, short for Break Point, sets the level at the end of the Decay time.

**Release [-99...+99]**

This sets the level at the end of the Release time.

**Time**

Higher values mean longer times, as shown below:

EG Value	Actual Time
00	0.667 ms
10	10 ms
20	44 ms
30	104 ms
40	224 ms
50	464 ms
60	944 ms
70	1.8 seconds
80	3.8 seconds
90	10.9 seconds
99	87.3 seconds

**Attack [00...99]**

This sets how long the EG takes to move from the Start level to the Attack level.

The minimum attack time is 2/3 of a millisecond—as fast as the most punchy of classic analog synths.

For the fastest possible attack time, you can set the Start level to +99; in this case, the EG will start instantaneously at its maximum value.

**Decay [00...99]**

This sets the time it takes to move from the Attack level to the Break level.

**Slope [00...99]**

This sets how long the EG takes to move from the Break level to the Sustain level (which for the Pitch EG is always 0). Once it reaches the Sustain, the EG will stay there until note-off, unless it is reset via AMS.

**Release [00...99]**

This sets how long it takes the EG to move from the Sustain level to the Release level.

## Curve

For the sake of simplicity, most of the diagrams in this manual show envelopes as being made out of straight lines. In actuality, though, envelopes are more likely to be made out of curves.

In other words, each segment's level will change quickly at first, and then slow down as it approaches the next point. This tends to sound better than straight, linear segments.

Classic analog synth envelopes made these curved shapes naturally. The KRONOS goes a step further than vintage synths, however, and lets you control the amount of curvature separately for each of the four envelope segments.

When you change the curvature, the EG times remain the same. However, greater curvature will tend to *sound* faster, because the value changes more quickly at the beginning.

### Pitch EG Curve

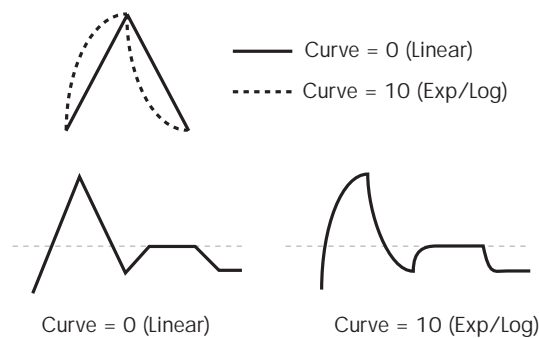

### Different curve settings for up and down

You may find that different amounts of curvature are suitable for segments which go up and segments which go down.

For instance, a curve of 3 is a good default setting for upward segments, such as Attack. On the other hand, a curve of 6 or more is good for downward segments, such as Decay and Release.

### Attack [0 (Linear), 1...9, 10 (Exp/Log)]

This sets the curvature of the Attack segment - the transition from the Start level to the Attack level.

### Decay [0 (Linear), 1...9, 10 (Exp/Log)]

This sets the curvature of the Decay segment - the transition from the Attack level to the Break level.

### Slope [0 (Linear), 1...9, 10 (Exp/Log)]

This sets the curvature of the Slope segment - the transition from the Break level to the Sustain level (which for the Pitch EG is always 0).

### Release [0 (Linear), 1...9, 10 (Exp/Log)]

This sets the curvature of the Release segment - the transition from the Sustain level to the Release level.

## 2-9c: Level Modulation

These settings let you use two different AMS sources to control the Level parameters of the EG. For each of the two AMS sources, the Start, Attack, Decay, and Break levels each have their own modulation intensities.

By using different settings for each of the three levels, you can cause both subtle and dramatic changes to the EG shape, as shown below.

### Pitch EG Level Modulation

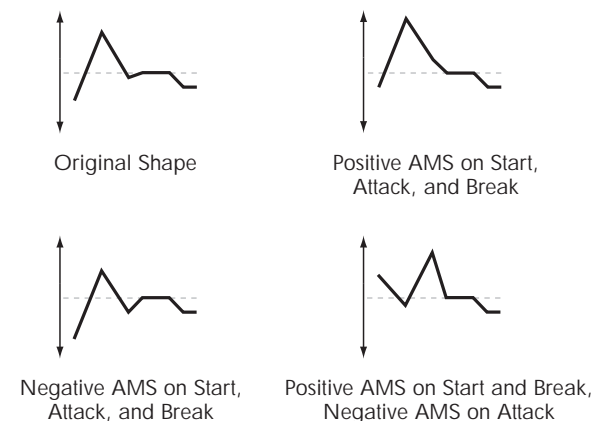

*Note:* Once the EG has started a segment between two points, that segment can no longer be modulated. This includes both the time of the segment, and the level reached at the end of the segment.

For instance, if the EG is in the middle of the Decay time, you can no longer modulate either the Decay time or the Break level.

This also means that modulating the Start level, Attack level, or Attack time will not affect notes that are already sounding, unless the EG is then re-started via EG Reset.

### AMS1 [List of AMS Sources]

This selects the first AMS source to control the EG's Level parameters.

For a list of AMS sources, see "Alternate Modulation Source (AMS) List" on page 1091.

### Start [-99...+99]

This controls the depth and direction of the AMS modulation for the Start level.

For example, if you set the AMS source to Velocity and set Start to +99, the Start level will increase as you play harder. If you instead set Start to -99, the Start level will decrease as you play harder.

### Attack [-99...+99]

This controls the depth and direction of the AMS modulation for the Attack level.

### Break [-99...+99]

This controls the depth and direction of the AMS modulation for the Break level.

## AMS2

This selects the second AMS source for controlling the EG's Level parameters. The Start, Attack, Decay, and Break levels share this source, but each has its own modulation intensity. The parameters of AMS2 are identical to those of AMS1, above.

- **1: Exclusive Solo.** For more information, see "Exclusive Solo" on page 147.
- **2: Copy Oscillator.** For more information, see "Copy Oscillator" on page 153.
- **3: Swap Oscillators.** For more information, see "Swap Oscillator" on page 153.

## 2-9d: Time Modulation

These settings let you use an AMS source to control the Time parameters of the EG. The Attack, Decay, Slope, and Release times share this AMS source, but each has its own modulation intensity.

### Pitch EG Time Modulation

AMS=Velocity, Intensity = a positive (+) value

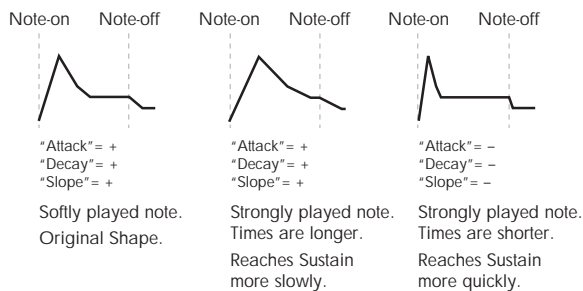

## AMS

### [List of AMS Sources]

This selects the AMS source to control the EG's Time parameters. Velocity and Keyboard Track can both be useful here, for instance.

For a list of AMS sources, see "Alternate Modulation Source (AMS) List" on page 1091.

## Attack

[-99...+99]

This controls the depth and direction of the AMS modulation for the Attack time.

For example, if you set the AMS source to Velocity and set Attack to +99, the Attack time will get much longer at higher velocities. If you instead set Attack to -99, the Attack time will get much shorter at higher velocities.

When the AMS source is at its maximum value—for instance, when Velocity is at 127—a setting of +8 will make the Attack time almost twice as long, and a setting of -8 will cut the Attack time almost in half.

## Decay

[-99...+99]

This controls the depth and direction of the AMS modulation for the Decay time.

## Slope

[-99...+99]

This controls the depth and direction of the AMS modulation for the Slope time.

## ▼ 2-9: Page Menu Commands

The number before each command shows its ENTER + number-key shortcut. For more information on these shortcuts, see "ENTER + 0-9: shortcuts for menu commands" on page 147.

- **0: Write Program.** For more information, see "Write Program" on page 147.

## Program P3: Filter

Filtering can make subtle or dramatic changes to the oscillator’s timbre. Each oscillator has two multimode resonant filters, A and B, as well as a dedicated filter envelope and keyboard tracking generator.

These pages let you control all aspects of the filters. Among other things, you can:

- Make basic settings for each oscillator’s filters, including routing, modes, cutoff, resonance, etc.

- Set up filter modulation, including keyboard tracking, the filter envelope, LFO modulation, and AMS control.

Note that when the **Oscillator Mode** is set to **Single**, only Oscillator 1’s filters are active; the pages for Oscillator 2’s filters will be grayed out.

### 3-1: Filter1

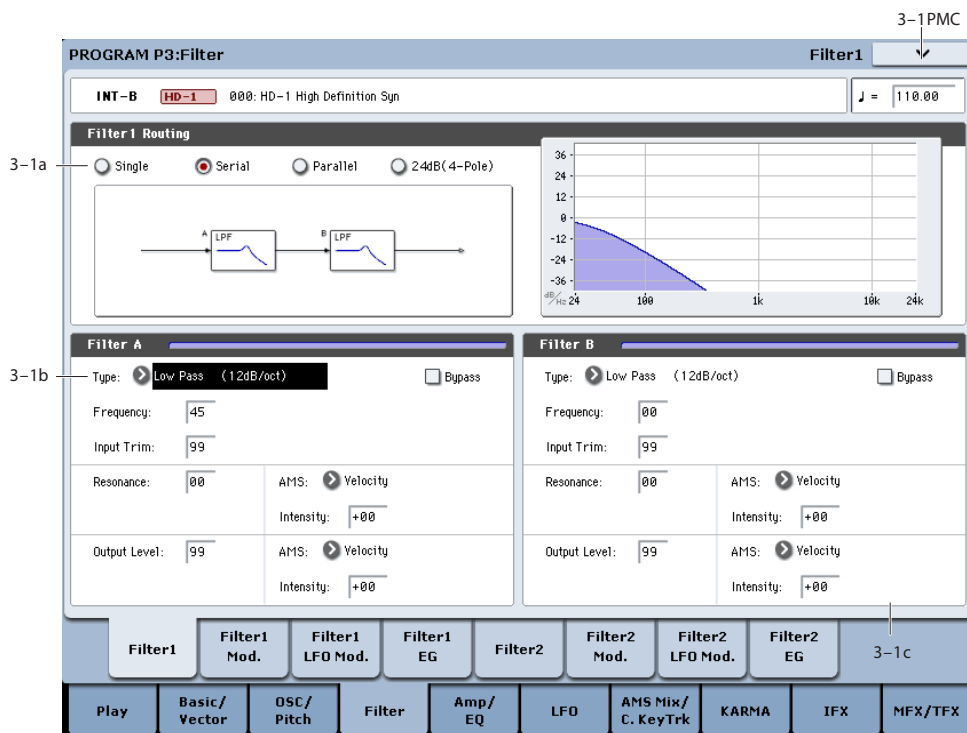

This page contains all of the basic settings for Oscillator 1’s Filter A and Filter B. For example, you can:

- Set up the filters to produce a single 12dB/oct filter, dual 12dB/oct filters in either serial or parallel routing, or a single 24dB/oct filter.
- Set each of the two filters to Low Pass, High Pass, Band Pass, or Band Reject modes.
- Set the cutoff, resonance, and input and output levels of each filter, including modulation of resonance and output level.

**Serial.** This uses both Filter A and Filter B. The oscillator first goes through Filter A, and then the output of Filter A is processed through Filter B.

**Parallel.** This also uses both Filter A and Filter B. The oscillator feeds both filters directly, and the outputs of the two filters are then summed together.

**24dB/oct.** This merges both filters to create a single 4-pole, 24dB/octave filter (12dB for Band Pass and Band Reject). In comparison to Single, this option produces a sharper roll-off beyond the cutoff frequency, as well as a slightly more delicate resonance. Many classic analog synths used this general type of filter.

When 24dB/oct is selected, only the controls for Filter A are active; the controls for Filter B will be grayed out.

#### 3-1a: Filter Routing

##### Filter Routing [Single, Serial, Parallel, 24dB/oct]

Each oscillator has two filters, Filter A and Filter B. This parameter controls whether one or both of the filters are used, and if both are used, it controls how they are connected to each other.

**Single.** This uses only Filter A as a single 2-pole, 12dB/octave filter (6dB for Band Pass and Band Reject). When this option is selected, the controls for Filter B will be grayed out.



Serial and Parallel Routing

**Serial**

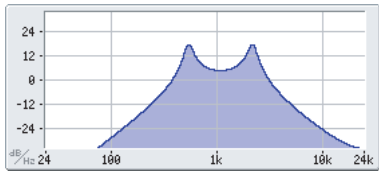

**Parallel**

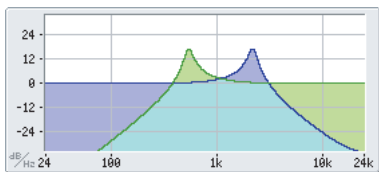
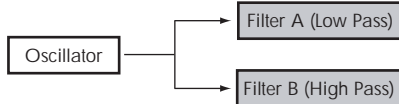

12db/oct / 24db/oct

Low Pass:  
12dB/oct

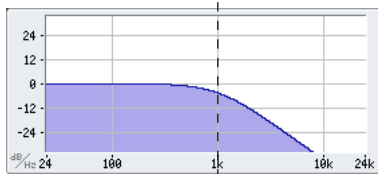

Low Pass:  
24dB/oct

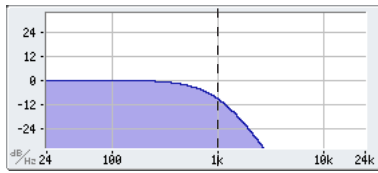

**3-1b: Filter A**

**Filter Type**

[Low Pass, High Pass,  
Band Pass, Band Reject]

The filter will produce very different results depending on the selected filter type. The selections will change slightly according to the selected **Filter Routing**, to show the correct cutoff slope in dB per octave.

**Low Pass.** This cuts out the parts of the sound which are **higher** than the cutoff frequency. Low Pass is the most common type of filter, and is used to make bright timbres sound darker.

**High Pass.** This cuts out the parts of the sound which are **lower** than the cutoff frequency. You can use this to make timbres sound thinner or more buzzy.

**Band Pass.** This cuts out all parts of the sound, both highs and lows, except for the region around the cutoff frequency. Since this filter cuts out both high and low frequencies, its effect can change dramatically depending on the cutoff setting and the oscillator's multisample.

With low resonance settings, you can use the Band Pass filter to create telephone or vintage phonograph sounds. With higher resonance settings, it can create buzzy or nasal timbres.

**Band Reject.** This filter type—also called a notch filter—cuts only the parts of the sound directly around the cutoff frequency. Try modulating the cutoff with an LFO to create phaser-like effects.

*Filter Types and Cutoff Frequency*

Low Pass

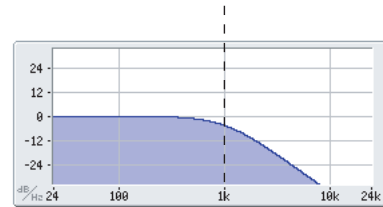

High Pass

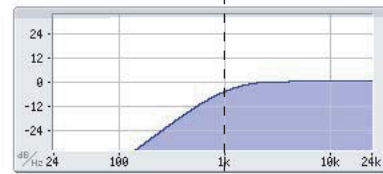

Band Pass

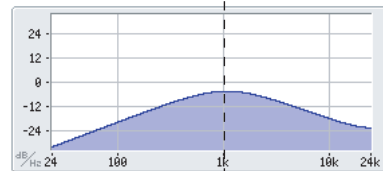

Band Reject

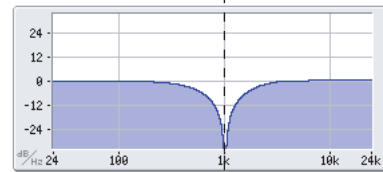

Cutoff Frequency

**Bypass**

[Off, On]

This lets you bypass Filter A completely.

If **Bypass** is **Off**, Filter A functions normally.

When **Bypass** is **On**, Filter A has no effect on the input signal.

**Frequency**

[00...99]

This controls the cutoff frequency of Filter A, in increments of 1/10 of an octave. The specific effect of the cutoff frequency will change depending on the selected **Filter Type**, as described above.

**Input Trim**

[00...99]

This adjusts the volume level at the input to the filter. If you notice that the sound is distorting, especially with high **Resonance** settings, you can turn the level down here, or at the Output Level.

*Note:* the filter will not clip internally, so there is no difference between adjusting the **Input Trim** and the **Output Level**. Either of these controls will allow you to minimize clipping later in the signal chain, such as may occur in the Drive section and in some effects.



Resonance

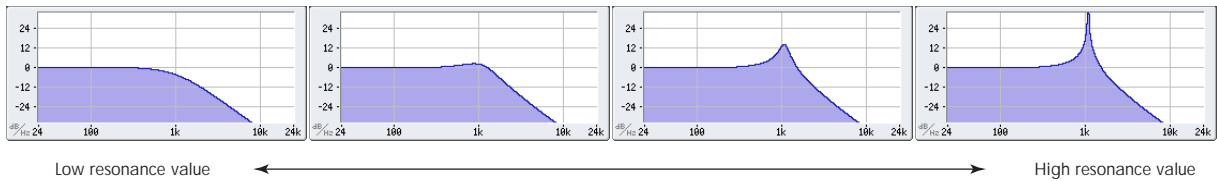

**Resonance** [00...99]

Resonance emphasizes the frequencies around the cutoff frequency.

When this is set to 0, there is no emphasis, and frequencies beyond the cutoff will simply diminish smoothly.

At medium settings, the resonance will alter the timbre of the filter, making it sound more nasal, or more extreme.

At very high settings, the resonance can be heard as a separate, whistling pitch.

To make the resonance track the keyboard pitch, see “Key Follow,” on page 74.

**AMS (Resonance)** [List of AMS Sources]

This selects a modulation source to control the Resonance amount. For a list of AMS sources, see “Alternate Modulation Source (AMS) List” on page 1091.

**Intensity** [-99...+99]

This controls the depth and direction of the Resonance modulation.

For example, if Velocity has been selected, changes in keyboard velocity will affect the resonance. With positive (+) values, the resonance will increase as you play more strongly, and as you play more softly the resonance will approach the level specified by the **Resonance** setting. With negative (-) values, the resonance will decrease as you play more strongly, and as you play more softly the resonance will approach the level specified by the **Resonance** setting.

The resonance level is determined by adding the **Resonance** and **Intensity** values.

**Output Level** [00...99]

This controls the output level of Filter A. You can use this to balance the volumes of Filters A and B when the **Routing** is set to Parallel, or to turn down the volume to avoid clipping later in the signal chain.

**AMS (Output Level)** [List of AMS Sources]

This selects a modulation source to control the output level of Filter A. For a list of AMS sources, see “Alternate Modulation Source (AMS) List” on page 1091.

**Intensity** [-99...+99]

This controls the depth and direction of the output level modulation.

**3-1c: Filter B**

Filter B is available when the **Filter Routing** is set to **Serial** or **Parallel**. Otherwise, the parameters in this section will be grayed out.

The parameters for Filter B are identical to those for Filter A. For more information, see the descriptions under Filter A, above.

**▼ 3-1: Page Menu Commands**

The number before each command shows its ENTER + number-key shortcut. For more information on these shortcuts, see “ENTER + 0-9: shortcuts for menu commands” on page 147.

- 0: **Write Program**. For more information, see “Write Program” on page 147.
- 1: **Exclusive Solo**. For more information, see “Exclusive Solo” on page 147.
- 2: **Copy Oscillator**. For more information, see “Copy Oscillator” on page 153.
- 3: **Swap Oscillators**. For more information, see “Swap Oscillator” on page 153.

## 3-2: Filter1 Modulation

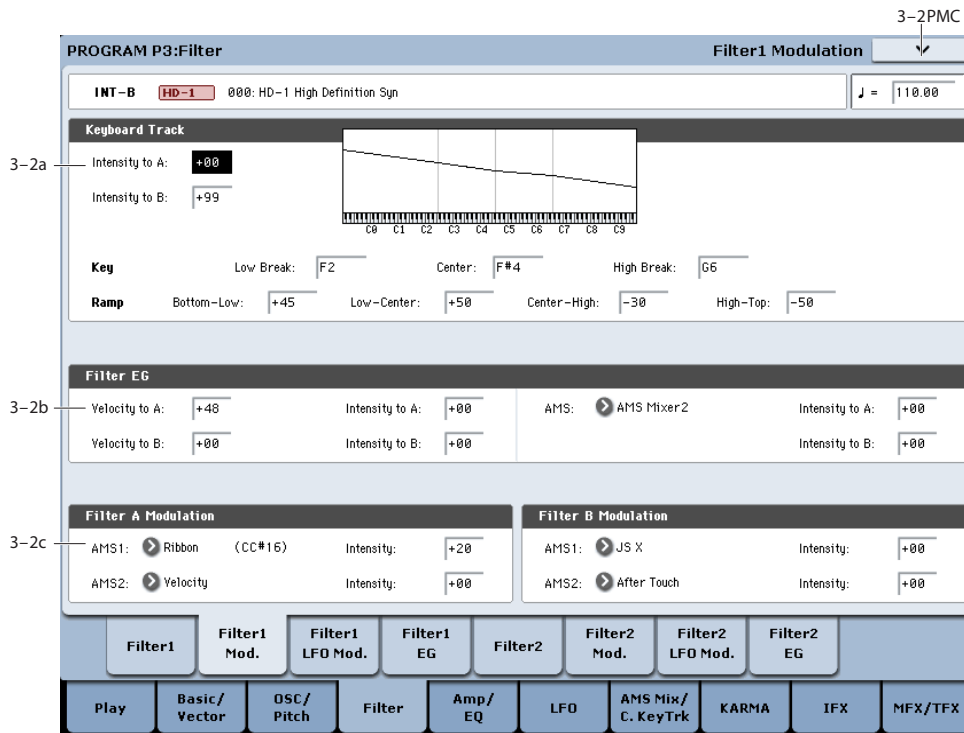

This page contains the settings for Oscillator 1's filter modulation. Among other things, you can:

- Set up complex keyboard tracking shapes, and control how the tracking affects filter cutoff.
- Control the effect of the Filter Envelope on filter cutoff.
- Assign AMS modulation for filter cutoff.

Filter B is available when the **Filter Routing** is set to **Serial** or **Parallel**. Otherwise, the parameters for Filter B will be grayed out.

### Filter Keyboard Tracking

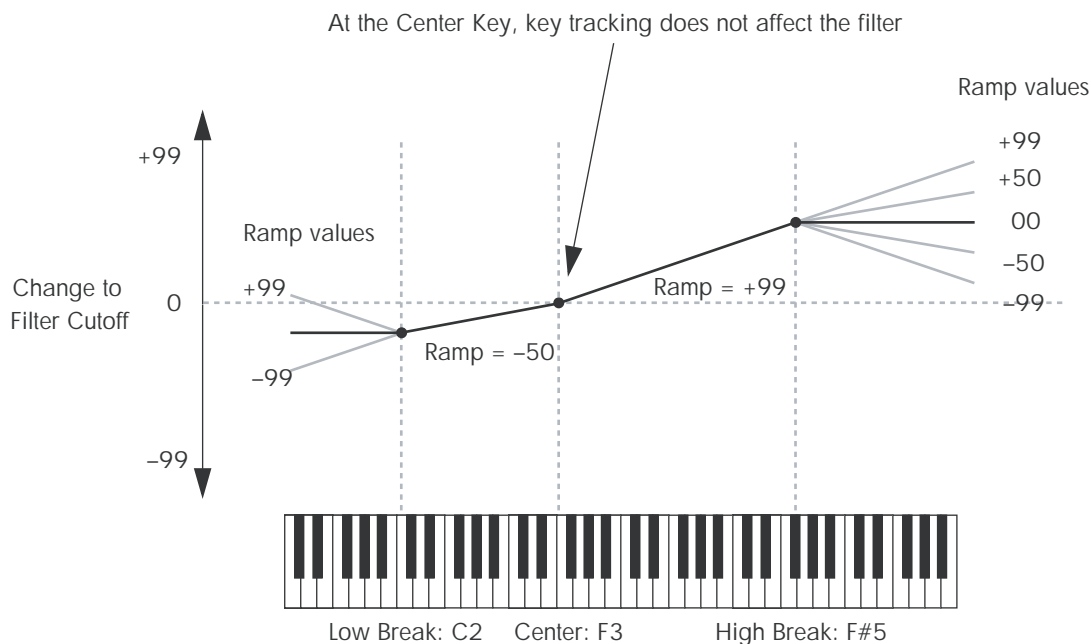

### 3-2a: Keyboard Track AMSource

Most acoustic instruments get brighter as you play higher pitches. At its most basic, keyboard tracking re-creates this effect by increasing the cutoff frequency of a lowpass filter as you play higher on the keyboard. Usually, some amount of key tracking is necessary in order to make the timbre consistent across the entire range.

The KRONOS keyboard tracking can also be much more complex, since it allows you to create different rates of change over up to four different parts of the keyboard. For instance, you can:

- Make the filter cutoff increase very quickly over the middle of the keyboard, and then open more slowly—or not at all—in the higher octaves.
- Make the cutoff increase as you play *lower* on the keyboard.
- Create abrupt changes at certain keys, for split-like effects.

### How it works: Keys and Ramps

The keyboard tracking works by creating four ramps, or slopes, between five keys on the keyboard. The bottom and top keys are fixed at the bottom and top of the MIDI range, respectively. You can set the other three keys—named **Low Break**, **Center**, and **High Break**—to be anywhere in between.

The four Ramp values control the rate of change between each pair of keys. For instance, if the **Low-Center** Ramp is set to 0, the value will stay the same between the **Low Break** key and the **Center** key.

You can think of the resulting shape as being like two folding doors attached to a hinge in the center. At the **Center** key (the main hinge), the keyboard tracking has no effect. The two folding doors swing out from this center point to create changes in the higher and lower ranges of the keyboard.

#### Intensity to A [-99...+99]

This controls how much the keyboard tracking will affect Filter A’s cutoff frequency. The overall effect of the Keyboard Track is a combination of this Intensity value and the overall Keyboard Track shape.

With **positive values (+)**, the effect will be in the direction specified by keyboard tracking; if the ramp goes up, the filter cutoff will **increase**.

With **negative values (-)**, the effect will be in the opposite direction; if the ramp goes up, the filter cutoff will *decrease*.

#### Intensity to B [-99...+99]

This controls how much the keyboard tracking will affect Filter B’s cutoff frequency.

### Key

#### Low Break [C-1...G9]

This sets the breakpoint note between the two lower ramps - the “hinge” of the lower door.

#### Center [C-1...G9]

This sets the center of the keyboard tracking - the main “hinge.” At this key, the keyboard tracking has no effect on the filter cutoff, or on any AMS destinations.

#### High Break [C-1...G9]

This sets the breakpoint note between the two higher ramps - the “hinge” of the upper door.

### Entering notes from the keyboard

You can enter note numbers directly by playing them on the keyboard. To do so:

1. **Select one of the Key parameters.**
2. **Hold down the ENTER key.**
3. **While holding ENTER, play a note on the keyboard.**

Keyboard Track Shape and Intensity

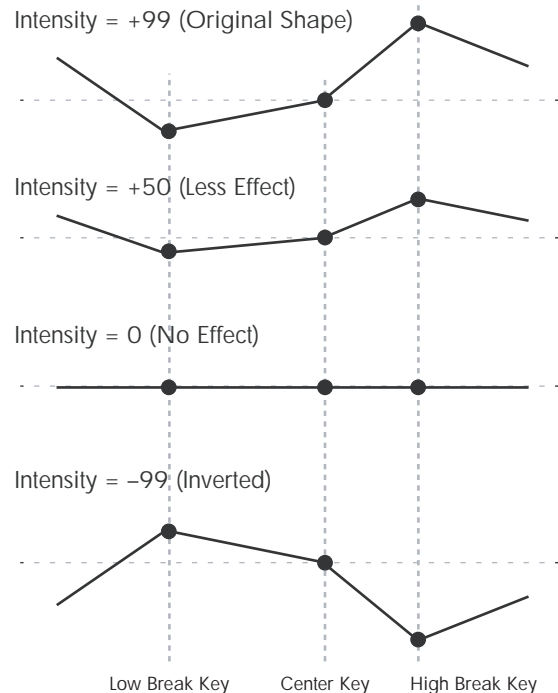

### Ramp

Positive ramp values mean that the keyboard tracking output increases as you play farther from the **Center Key**; negative ramp values mean that it decreases.

Because of this, the meanings of positive and negative ramp settings will change depending on whether the ramp is to the left or right of the **Center Key**.

**Bottom-Low and Low-Center:** negative ramps make the keyboard tracking’s output go down as you play lower on the keyboard, and positive ramps make the output go higher.

**Center-High and High-Top:** negative ramps make the keyboard tracking’s output go down as you play *higher* on the keyboard, and positive ramps make the output go up.

The effect on the filter cutoff is a combination of the ramp values, as set below, and the Intensity to A and B parameters. When Intensity is set to +99, a ramp of 50 changes the filter frequency by 1 octave for every octave of the keyboard, and a ramp of +99 changes the frequency by 2 octaves for every octave of the keyboard.

#### Bottom-Low [-Inf, -99...+99, +Inf]

This sets the slope between the bottom of the MIDI note range and the Low Break key. For normal key track, use negative values.

**Low-Center** [-Inf, -99...+99, +Inf]

This sets the slope between the Low Break and Center keys. For normal key track, use negative values.

**Center-High** [-Inf, -99...+99, +Inf]

This sets the slope between the Center and High Break keys. For normal key track, use positive values.

**High-Top** [-Inf, -99...+99, +Inf]

This sets the slope between the High Break key and the top of the MIDI note range. For normal key track, use positive values.

**+Inf and -Inf ramps**

+Inf and -Inf are special settings which create abrupt changes for split-like effects. When a ramp is set to +Inf or -Inf, the keyboard tracking will go to its extreme highest or lowest value over the span of a single key.

*+Inf and -Inf Ramps*

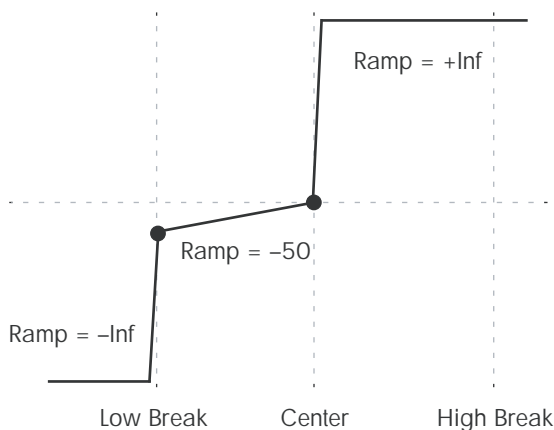

*Note:* if you set the Center-High ramp to +Inf or -Inf, the High-Top parameter will be grayed out. Similarly, if you set the Low-Center ramp to +Inf or -Inf, the Bottom-Low ramp will be grayed out.

**Key Follow**

To create the classic Key Follow effect, in which the filter frequency tracks the pitch of the keyboard:

1. Set the Filter Frequency to 30.
2. Set the Keyboard Track Intensity to +99.
3. Set the Bottom-Low and Low-Center ramps to -50.
4. Set the Center-High and High-Top ramps to +50.
5. Set the Center Key to C4.

The settings for the Low Break and High Break keys don't matter in this case.

**Filter Keyboard Track is also an AMS source**

You can use the keyboard tracking as an AMS source to modulate other parameters, just like the envelopes and LFOs. Simply select Filter Keytrack in the AMS list for the desired parameter.

**3-2b: Filter EG**

The Filter1 EG modulates the Filter A and B cutoff frequencies over time. You can control how strongly the EG will affect the filters in three different ways:

- Set an initial amount of EG modulation, using the Intensity to A and B parameters.
- Use velocity to scale the amount of the EG applied to the filter.
- Use any AMS source to scale the amount of the EG applied to the filter.

You can use all three of these at once, and the results are added together to produce the total EG effect.

To set up the EG itself, including attack and release times, levels, and so on, see "3-4: Filter1 EG," on page 77.

**Velocity to A** [-99...+99]

This lets you use velocity to scale the amount of the Filter EG applied to Filter A.

*Velocity control of Filter EG*

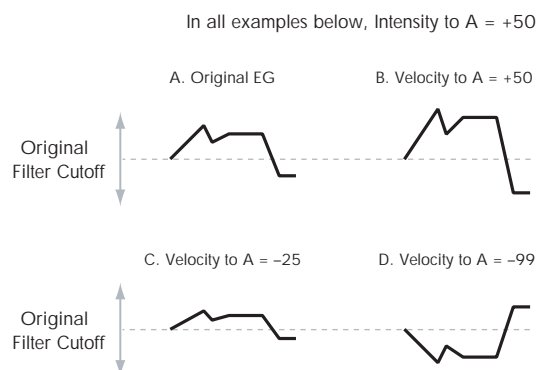

With **positive (+) values**, playing more strongly will increase the effect of the Filter EG, as shown in example **B** above.

With **negative (-) values**, playing more strongly will introduce the *opposite* effect of the Filter EG—like inverting the polarity of the envelope. You can use this in several different ways:

- You can set an initial positive amount with the Intensity to A/B parameters, and then reduce this amount with velocity. In this case, the final effect of the EG is simply diminished, and not actually inverted, as shown in example **C** above.
- You can also set the Velocity to A/B amounts so that they are greater than the initial amounts of Intensity to A/B. In this case, the EG will have a positive effect at low velocities, and an inverted effect at high velocities—as shown in example **D**.

**Velocity to B** [-99...+99]

This lets you use velocity to scale the amount of the Filter EG applied to Filter B. For more information, see "Velocity to A," above.

**Intensity to A** [-99...+99]

This controls the initial effect of the Filter EG on Filter A's cutoff frequency, before any velocity or AMS modulation.

The Filter EG's shape can swing all the way from +99 to -99. Positive values increase the cutoff frequency, and negative values decrease the cutoff frequency. For instance, see the graphic "Velocity to A," above. The EG shape in example A rises up at first, and then falls below 0 towards the end.

When Intensity to A is set to a **positive (+)** value, EG's effect will match its shape. When the EG rises above 0, the cutoff frequency will increase.

With **negative (-)** values, the effect will be in the opposite direction; when the EG rises above 0, the filter cutoff will *decrease*.

**Intensity to B** [-99...+99]

This controls the initial effect of the Filter EG on Filter B's cutoff frequency, before any velocity or AMS modulation. For more information, see "Intensity to A," above.

**AMS (Filter EG)** [List of AMS Sources]

This selects any AMS modulation source to scale the amount of the Filter EG applied to Filters A and B. The two filters share a single AMS source, with separate intensity settings. Otherwise, the AMS modulation will work in the same way as the **Velocity to A** parameter, described above.

For a list of AMS sources, see "Alternate Modulation Source (AMS) List" on page 1091.

**Intensity to A** [-99...+99]

This controls the depth and direction of the EG AMS modulation for Filter A.

**Intensity to B** [-99...+99]

This controls the depth and direction of the EG AMS modulation for Filter B.

---

### 3-2c: Filter A/B Modulation

This section lets you assign any two AMS sources to control Filter A, and another two AMS sources to control Filter B. This modulation is added to the basic Filter A and B cutoff frequencies, as set on the Filter 1 page.

#### Filter A

**AMS1** [List of AMS Sources]

This selects the first modulation source for controlling Filter A's cutoff frequency. For a list of AMS sources, see "Alternate Modulation Source (AMS) List" on page 1091.

**Intensity (AMS1)** [-99...+99]

This controls the depth and direction of AMS1.

**AMS2** [List of AMS Sources]

This selects the second modulation source for controlling Filter A's cutoff frequency. For a list of AMS sources, see "Alternate Modulation Source (AMS) List" on page 1091.

**Intensity (AMS2)** [-99...+99]

This controls the depth and direction of AMS2.

#### Filter B

The parameters for Filter B are identical to those for Filter A. For more information, see the descriptions under Filter A, above.

---

### ▼ 3-2: Page Menu Commands

The number before each command shows its ENTER + number-key shortcut. For more information on these shortcuts, see "ENTER + 0-9: shortcuts for menu commands" on page 147.

- 0: **Write Program**. For more information, see "Write Program" on page 147.
- 1: **Exclusive Solo**. For more information, see "Exclusive Solo" on page 147.
- 2: **Copy Oscillator**. For more information, see "Copy Oscillator" on page 153.
- 3: **Swap Oscillators**. For more information, see "Swap Oscillator" on page 153.

### 3-3: Filter1 LFO Modulation

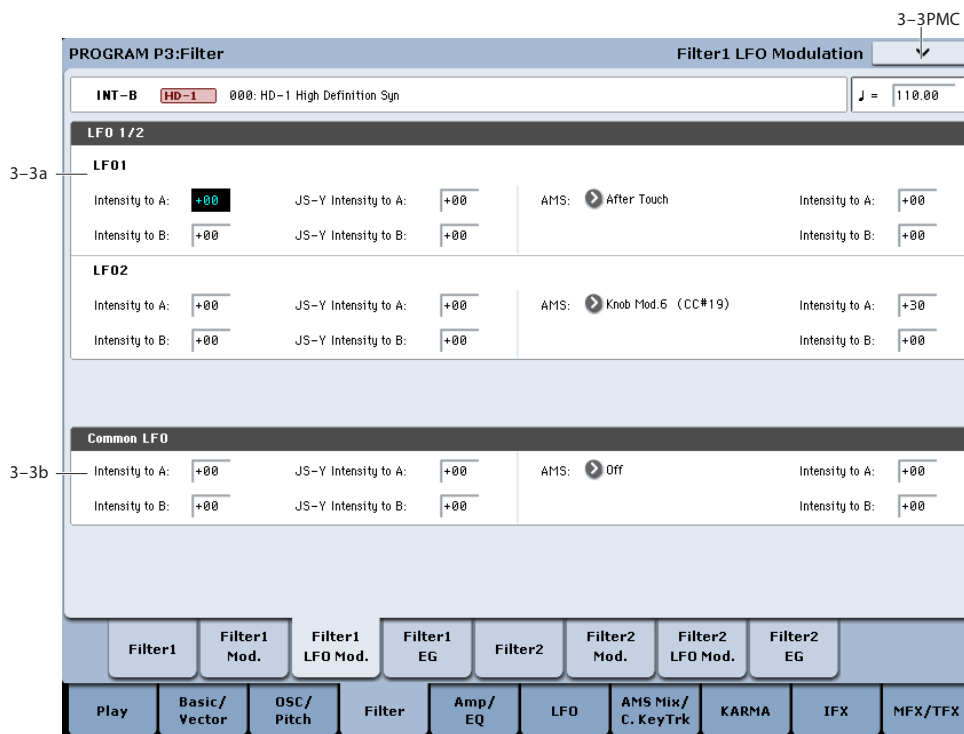

LFO1, LFO2, and the Common LFO can all modulate Filter A and B's cutoff frequencies. You can control the strength of each LFO's modulation in three different ways, independently for each filter:

- Set an initial amount of LFO modulation, using the Intensity to A and B parameters.
- Use JS-Y to scale the amount of the LFO.
- Use any AMS source to scale the amount the LFO.

You can use each of these methods for each of the three LFOs, and do so separately for both Filter A and Filter B. The results are added together to produce the total LFO effect.

#### 3-3a: LFO 1/2

##### LFO1

##### Intensity to A (LFO1) [-99...+99]

This controls the initial effect of the LFO on Filter A's cutoff frequency, before any JS-Y or AMS modulation.

**Negative (-)** settings will invert the phase of the LFO. You can produce interesting effects by using the same LFO to modulate two different parameters (such as Filter A and Filter B), but with one set to a positive intensity, and the other set to a negative intensity.

*LFO modulation of Filter Cutoff*

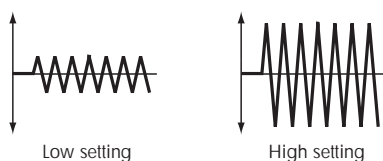

##### Intensity to B (LFO1) [-99...+99]

This controls the initial effect of the LFO on Filter B's cutoff frequency, before any JS-Y or AMS modulation.

##### JS-Y Intensity to A (LFO1) [-99...+99]

Moving the joystick "down" from the center detent position, towards yourself, produces the JS-Y controller. You can use this to scale the amount of the LFO applied to Filter A.

**Negative (-)** settings will invert the phase of the LFO. You can also use this to reduce the initial amount of the LFO, as set by **Intensity to A**, above. For example:

1. Set **Intensity to A** to +50.

The LFO will now have a fairly strong effect on the filter cutoff.

2. Set **JS-Y Intensity to A** to -50.

Now, if you move the joystick down, the effect of the LFO will fade away. When the joystick is all the way at the bottom of its range, the LFO will be completely cancelled out.

##### JS-Y Intensity to B (LFO1) [-99...+99]

This lets you use JS-Y to scale the amount of the LFO applied to Filter B.

##### AMS (LFO1) [List of AMS Sources]

This selects any AMS modulation source to scale the amount of the LFO applied to Filters A and B. The two filters share a single AMS source, but with separate intensity settings.

For a list of AMS sources, see "Alternate Modulation Source (AMS) List" on page 1091.

**Intensity to A** [-99...+99]

This controls the depth and direction of the LFO1 AMS modulation for Filter A.

For example, if AMS is set to **After Touch**, positive settings mean that aftertouch will increase the amount of LFO1 applied to Filter A.

**Intensity to B** [-99...+99]

This controls the depth and direction of the LFO1 AMS modulation for Filter B.

**LFO 2**

The parameters for LFO2 are identical to those for LFO1. For more information, see the descriptions under LFO1, above.

**3-3b: Common LFO**

The parameters for the Common LFO are identical to those for LFO1. For more information, see the descriptions under LFO1, above.

Note that while LFO1 and LFO2 are separate for each voice, the Common LFO is shared by all voices in the Program. This makes it useful when you want all of the voices to have an identical LFO effect.

**▼ 3-3: Page Menu Commands**

The number before each command shows its ENTER + number-key shortcut. For more information on these shortcuts, see “ENTER + 0-9: shortcuts for menu commands” on page 147.

- 0: **Write Program.** For more information, see “Write Program” on page 147.
- 1: **Exclusive Solo.** For more information, see “Exclusive Solo” on page 147.
- 2: **Copy Oscillator.** For more information, see “Copy Oscillator” on page 153.
- 3: **Swap Oscillators.** For more information, see “Swap Oscillator” on page 153.

**3-4: Filter1 EG** AMSource

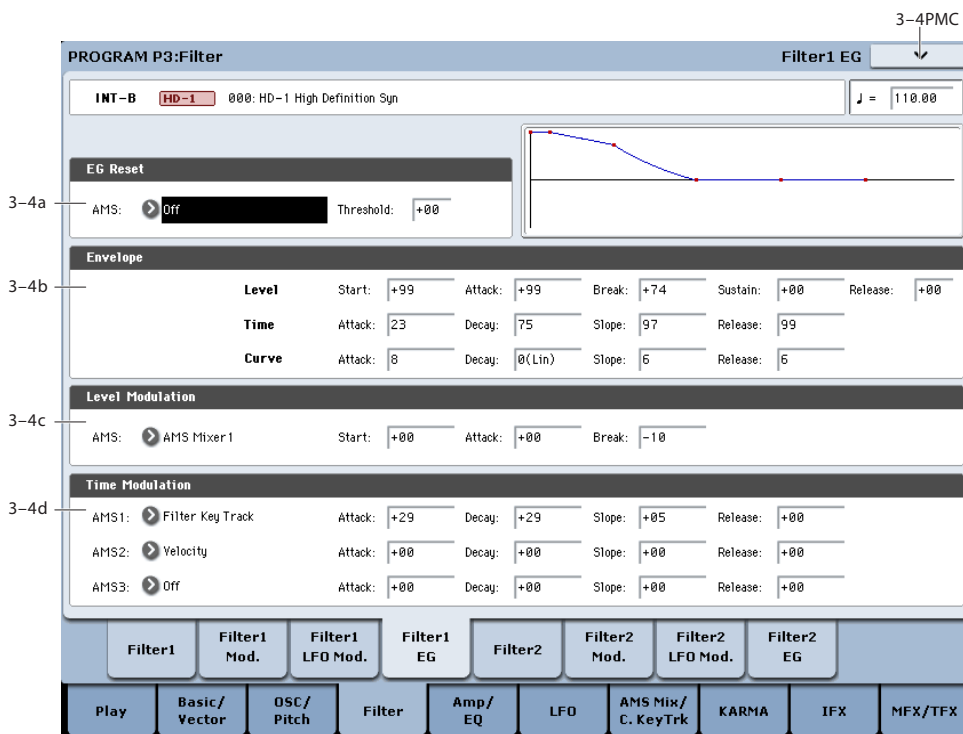

The Filter EG, or Envelope Generator, lets you create complex, time-varying changes to the cutoff frequencies of Filters A and B. The parameters on this page control the shape of the EG. Among other things, you can:

- Create the basic EG shape by setting the levels and times of each segment.
- Control the curvature of each EG segment, for subtle control over the sound of the EG.
- Set up complex modulation of EG levels and times.
- Set up an AMS source, such as an LFO, to restart the EG.

To control how much effect the EG has on the filters, use the Filter EG parameters on the Filter Mod page, as described under “3-2b: Filter1 EG,” on page 74.

**Filter EG is also an AMS source**

You can use the Filter EG as an AMS source to modulate other parameters, just like the keyboard tracking and LFOs. Simply select the Filter EG in the AMS list for the desired parameter.



### 3-4a: EG Reset

#### AMS (EG Reset) [List of AMS Sources]

This selects an AMS source to reset the EG to the start point. For instance, you can use a tempo-synced LFO to trigger the EG in a repeating rhythm. This reset is in addition to the initial note-on, which always causes the EG to start.

For a list of AMS sources, see “Alternate Modulation Source (AMS) List” on page 1091.

#### Threshold [-99...+99]

This sets the AMS level which will trigger the EG reset. Among other things, you can use this to adjust the exact point in an LFO’s phase at which the EG will be reset, effectively controlling its “groove” against other rhythmic effects.

When the threshold is **positive**, the EG triggers when passing through the threshold moving upwards. When the threshold is **negative**, the EG triggers when passing through the threshold moving downwards.

**Note:** with some LFO shapes, and with faster LFO speeds, the LFO may not always reach the extreme values of +99 or -99. In this case, setting the **Threshold** to these values may cause inconsistent behavior, or may mean that the EG doesn’t reset at all. If this happens, reduce the **Threshold** until the EG triggers consistently.

### 3-4b: Envelope

Filter EG

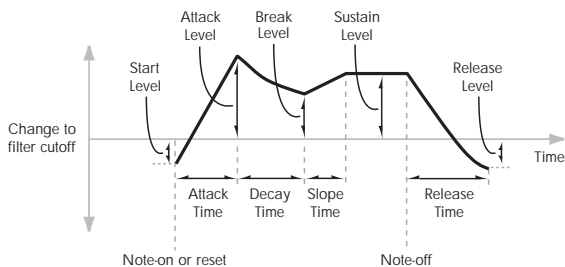

An envelope creates a modulation signal by moving from one level to another over a specified time, and then moving to another level over another period of time, and so on.

The parameters below let you set five levels, the amount of time it takes to go from each of the levels to the next, and the shape (from linear to curved) of each transition.

#### Level

Each of the five levels can be either positive or negative.

**Positive** levels will make the cutoff frequency (or other AMS destination) go up from its programmed value; **negative** levels will make it go down.

#### Start [-99...+99]

This sets the initial EG level, at note-on.

#### Attack [-99...+99]

This sets the level at the end of the Attack time.

#### Break [99...+99]

Break, short for Break Point, sets the level at the end of the Decay time.

#### Sustain [-99...+99]

This sets the level at the end of the Slope time. Once it reaches the Sustain level, the EG will stay there until note-off, unless it is reset via AMS.

#### Release [-99...+99]

This sets the level at the end of the Release time.

#### Time

Higher values mean longer times, as shown below:

EG Value	Actual Time
00	0.667 ms
10	10 ms
20	44 ms
30	104 ms
40	224 ms
50	464 ms
60	944 ms
70	1.8 seconds
80	3.8 seconds
90	10.9 seconds
99	87.3 seconds

#### Attack [00...99]

This sets how long the EG takes to move from the Start level to the Attack level.

The minimum attack time is 2/3 of a millisecond—as fast as the most punchy of classic analog synths.

For the fastest possible attack time, you can set the Start level to +99; in this case, the EG will start instantaneously at its maximum value.

#### Decay [00...99]

This sets the time it takes to move from the Attack level to the Break level.

#### Slope [00...99]

This sets how long the EG takes to move from the Break level to the Sustain level. Once it reaches the Sustain level, the EG will stay there until note-off (unless it is reset via AMS).

#### Release [00...99]

This sets how long it takes the EG to move from the Sustain level to the Release level.

#### Curve

For the sake of simplicity, most of the diagrams in this manual show envelopes as being made out of straight lines. In actuality, though, envelopes are more likely to be made out of curves.

In other words, each segment's level will change quickly at first, and then slow down as it approaches the next point. This tends to sound better than straight, linear segments.

Classic analog synth envelopes made these curved shapes naturally. The KRONOS goes a step further than vintage synths, however, and lets you control the amount of curvature separately for each of the four envelope segments.

*Filter EG Curve*

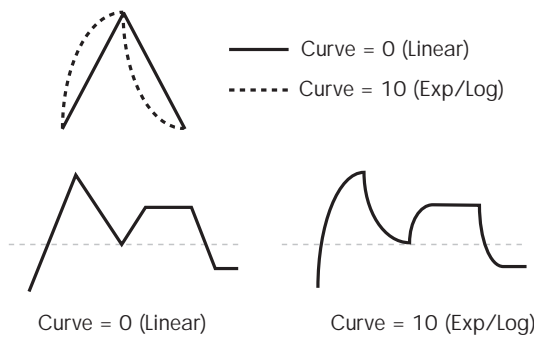

When you change the curvature, the EG times remain the same. However, greater curvature will tend to sound faster, because the value changes more quickly at the beginning.

**Different curve settings for up and down**

You may find that different amounts of curvature are suitable for segments which go up and segments which go down.

For instance, a curve of 3 is a good default setting for upward segments, such as Attack. On the other hand, a curve of 6 or more is good for downward segments, such as Decay and Release.

**Attack [0 (Linear), 1...9, 10 (Exp/Log)]**

This sets the curvature of the Attack segment - the transition from the Start level to the Attack level.

**Decay [0 (Linear), 1...9, 10 (Exp/Log)]**

This sets the curvature of the Decay segment - the transition from the Attack level to the Break level.

**Slope [0 (Linear), 1...9, 10 (Exp/Log)]**

This sets the curvature of the Slope segment - the transition from the Break level to the Sustain level.

**Release [0 (Linear), 1...9, 10 (Exp/Log)]**

This sets the curvature of the Release segment - the transition from the Sustain level to the Release level.

**3-4c: Level Modulation**

These settings let you use any AMS source to control the Level parameters of the EG. The Start, Attack, and Break levels share a single AMS source, but can each have different modulation intensities.

By using different settings for each of the three levels, you can cause both subtle and dramatic changes to the EG shape, as shown below.

*Filter EG Level Modulation*

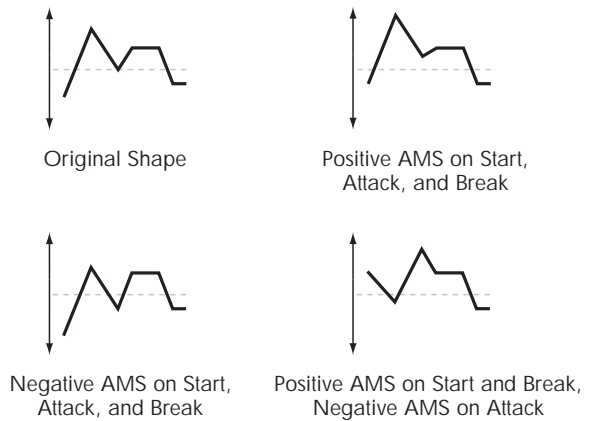

**Once an EG segment begins, it can't be modulated**

Once the EG has started a segment between two points, that segment can no longer be modulated. This includes both the time of the segment, and the level reached at the end of the segment.

For instance, if the EG is in the middle of the Decay time, you can no longer modulate either the Decay time or the Break level.

As another example, let's say that you've assigned the Common LFO to modulate Break Level. The LFO may be moving all the time, but the Break Level is only affected by the LFO's value at the instant that the Decay segment starts. After that, the level is fixed.

Finally, this also means that modulating the Start level, Attack level, or Attack time will not affect notes that are already sounding, unless the EG is then reset via AMS.

**AMS [List of AMS Sources]**

Selects an AMS source to control the EG's Level parameters.

For a list of AMS sources, see "Alternate Modulation Source (AMS) List" on page 1091.

**Start [-99...+99]**

This controls the depth and direction of the AMS modulation for the Start level.

For example, if you set the AMS source to Velocity and set Start to +99, the Start level will increase as you play harder. If you instead set Start to -99, the Start level will decrease as you play harder.

**Attack [-99...+99]**

This controls the depth and direction of the AMS modulation for the Attack level.

**Break [-99...+99]**

This controls the depth and direction of the AMS modulation for the Break level.

### 3-4d: Time Modulation

These settings let you use three different AMS sources to control the Time parameters of the EG. For each of the three AMS sources, the Attack, Decay, Slope, and Release times each have their own modulation intensities.

#### Filter EG Time Modulation

AMS=Velocity, Intensity = a positive (+) value

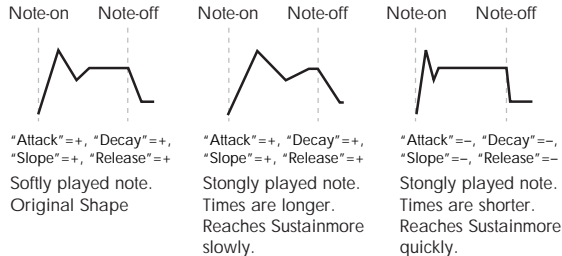

#### AMS1

#### [List of AMS Sources]

Selects the first AMS source to control the EG's Time parameters. Velocity and Keyboard Track can both be useful here, for instance.

For a list of AMS sources, see "Alternate Modulation Source (AMS) List" on page 1091.

#### Attack

[-99...+99]

This controls the depth and direction of the AMS modulation for the Attack time.

For example, if you set the AMS source to Velocity and set Attack to +99, the Attack time will get much longer at higher velocities. If you instead set Attack to -99, the Attack time will get much shorter at higher velocities.

When the AMS source is at its maximum value—for instance, when Velocity is at 127—a setting of +8 will make the Attack time almost twice as long, and a setting of -8 will cut the Attack time almost in half.

### 3-5: Filter2

This page controls Oscillator 2's basic filter settings. It is available only when the **Oscillator Mode** is set to **Double**; if not, the page will be grayed out.

#### Decay

[-99...+99]

This controls the depth and direction of the AMS modulation for the Decay time.

#### Slope

[-99...+99]

This controls the depth and direction of the AMS modulation for the Slope time.

#### Release

[-99...+99]

This controls the depth and direction of the AMS modulation for the Release time.

#### AMS2 and AMS3

These select the second and third AMS sources, respectively, for controlling the EG's Time parameters. Each has its own intensities for Attack, Decay, Slope, and Release. The parameters of both AMS2 and AMS3 are identical to those of AMS1, above.

### ▼ 3-4: Page Menu Commands

The number before each command shows its ENTER + number-key shortcut. For more information on these shortcuts, see "ENTER + 0-9: shortcuts for menu commands" on page 147.

- 0: **Write Program**. For more information, see "Write Program" on page 147.
- 1: **Exclusive Solo**. For more information, see "Exclusive Solo" on page 147.
- 2: **Copy Oscillator**. For more information, see "Copy Oscillator" on page 153.
- 3: **Swap Oscillators**. For more information, see "Swap Oscillator" on page 153.
- 4: **Sync Both EGs**. For more information, see "Sync Both EGs" on page 155.

### 3-6: Filter2 Modulation

This page controls Oscillator 2's filter modulation. It is available only when the **Oscillator Mode** is set to **Double**; if not, the page will be grayed out.

The parameters are identical to those for Oscillator 1, as described under "3-1: Filter1," on page 69.

The parameters are identical to those for Oscillator 1, as described under "3-2: Filter1 Modulation," on page 72.

### 3-7: Filter2 LFO Modulation

This page controls Oscillator 2's LFO filter modulation. It is available only when the **Oscillator Mode** is set to **Double**; if not, the page will be grayed out.

The parameters are identical to those for Oscillator 1, as described under "3-3: Filter1 LFO Modulation," on page 76.

### 3-8: Filter2 EG AMSource

This page controls Oscillator 2's Filter EG. It is available only when the **Oscillator Mode** is set to **Double**; if not, the page will be grayed out.

The parameters are identical to those for Oscillator 1, as described under "3-4: Filter1 EG," on page 77.

## Program P4: Amp/EQ

Oscillators 1 and 2 have separate controls for volume (also called “amplitude,” or “amp” for short), pan, and Drive, as well as dedicated amp envelopes and keyboard tracking generators. Additionally, both Oscillators share a three-band EQ.

These pages let you control all of these related parameters. Among other things, you can:

- Set up the Driver circuit, which adds saturation and bass boost to the timbre.

- Set the pan position and pan modulation.
- Control amp level and modulation, including keyboard tracking, the amp envelope, LFO modulation, and AMS control.
- Set up the three-band Track EQ.

Note that when the **Oscillator Mode** is set to **Single**, only Oscillator 1’s amp, pan, and drive parameters are active; the pages for Oscillator 2 will be grayed out.

### 4–1: Amp1/Driver1

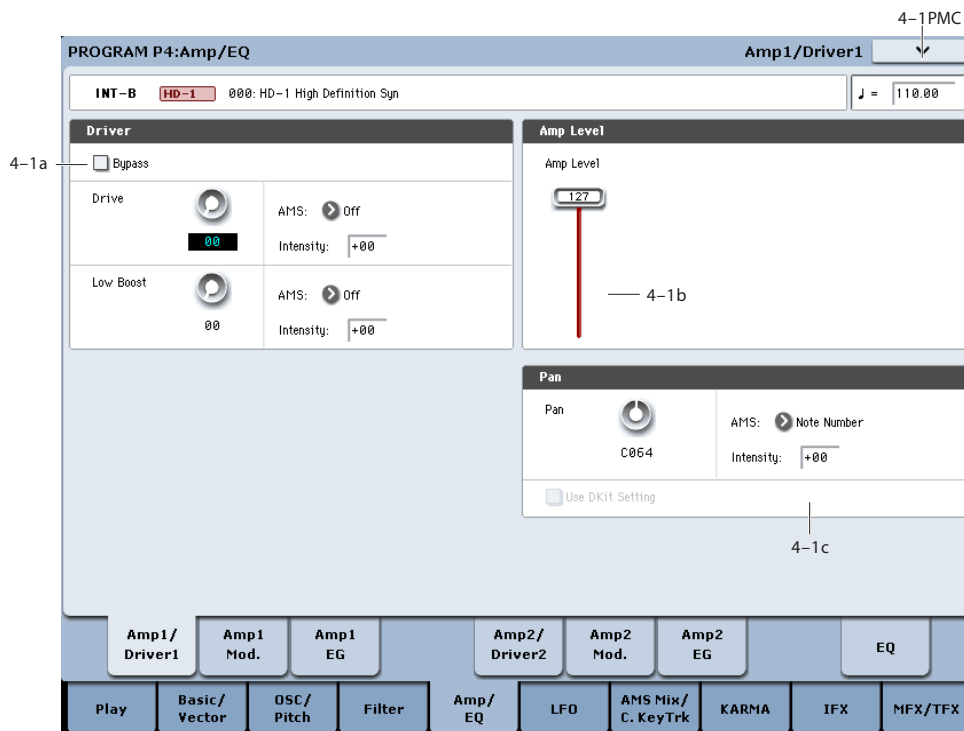

This page controls the basic settings for the Amp/EQ section. Here, you can:

- Set up the Driver circuit.
- Set the initial volume level.
- Control the pan position and pan modulation.

#### 4–1a: Driver

The Driver adds saturation and overdrive to the sound, for everything from subtle fattening to drastic distortion. Unlike an overdrive effect, the Driver processes each voice individually, so the timbre stays the same regardless of how many voices are being played.

The two main parameters, Drive and Low Boost, work together to create the overall Driver effect. Drive contributes edge and bite, and Low Boost provides the body as well as boosting the bass.

**Bypass** [Off, On]

When Bypass is On, the Driver is completely removed from the signal path.

**Drive** [00...99]

This controls the amount of edge and bite in the timbre. Low settings will produce mild saturation, and higher settings create more obvious distortion.

Often, it’s useful to increase the Low Boost along with the Drive.

*Note:* even when the Drive amount is set to 0, the Driver circuit still affects the timbre. If your goal is a completely pristine sound, use the Bypass control instead.

**AMS (Drive)** [List of AMS Sources]

This selects an AMS modulation source to control the Drive amount. For a list of AMS sources, see “Alternate Modulation Source (AMS) List” on page 1091.

**Intensity** [–99...+99]

This controls the depth and direction of the AMS modulation for Drive.

**Low Boost** [00...99]

This low-frequency EQ controls the body character of the sound. The specific EQ frequencies affected will change with the Drive setting.

Higher amounts increase the bass boost, and will also intensify the effect of the Drive parameter.

**AMS (Low Boost)** [List of AMS Sources]

This selects an AMS modulation source to control the Low Boost amount. For a list of AMS sources, see “Alternate Modulation Source (AMS) List” on page 1091.

**Intensity** [-99...+99]

This controls the depth and direction of the AMS modulation for Low Boost.

---

**4-1b: Amp Level**

**Amp Level** [000...127]

This controls the basic volume level of Oscillator 1, before keyboard tracking, velocity, and other modulation.

**The Control Surface and volume**

You can control the Oscillator volume directly from the Control Surface sliders. This is a separate parameter, in addition to Amp Level. To do so:

1. Press the Control Surface Timbre/Track button.
2. Move Slider 1 to set the volume for Oscillator 1, and Slider 2 for Oscillator 2.

**MIDI and volume**

**MIDI** You can control the Program’s overall volume via MIDI using both Volume (CC#7) and Expression (CC#11). When used one at a time, the two controllers work in exactly the same way: a MIDI value of 127 is equal to the Amp Level setting, and lower values reduce the volume.

If both CC#7 and CC#11 are used simultaneously, the one with the *lower* value determines the maximum volume, and the one with the higher value scales down from that maximum. This is controlled on the global MIDI channel.

---

**4-1c: Pan**

**Pan** [Random, L001...C064...R127]

This controls the stereo pan of Oscillator 1. A setting of L001 places the sound at the far left, C064 in the center, and R127 to the far right.

When this is set to **Random**, the pan position will be different for each note-on.

You can also set the Pan directly from the Control Surface knobs. To do so:

1. Press the Control Surface Timbre/Track button.
2. Set the MIXER KNOBS switch to INDIVIDUAL PAN.
3. Move Knob 1 to set the pan for Oscillator 1, and Knob 2 to set the pan for Oscillator 2.

**MIDI** You can also control pan via MIDI Pan (CC#10). A CC#10 value of 0 or 1 places the sound at the far left, 64 places the sound at the location specified by the **Pan** parameter, and 127 places the sound at the far right.

*Note:* you can select Random pan only from the on-screen UI, and not from MIDI or the Control surface.

**AMS (Pan)** [List of AMS Sources]

This selects an AMS source to modulate Pan. For a list of AMS sources, see “Alternate Modulation Source (AMS) List” on page 1091.

**Intensity** [-99...+99]

This controls the depth and direction of the AMS modulation for Pan.

For example, if **Pan** is set to C064 and **AMS** is set to Note Number, **positive (+)** intensities will cause the sound to move toward the right as you play higher than C4, and toward the left as you play lower than C4.

**Negative (-)** intensities will have the opposite effect.

**Use DKit Setting** [Off, On]

This option is available only when the **Oscillator Mode** is set to **Drums** or **Double Drums**.

Unlike standard Programs, Drum Kits can have a different pan setting for every note. This parameter lets you choose whether to use the Drum Kit pan settings, or to use the Program’s pan setting instead.

**On (checked):** The Program will use the Drum Kit’s per-note pan settings; pan AMS will still apply. This is the default setting.

**Off (unchecked):** The Program will ignore the Drum Kit’s settings, and use the Program pan instead. All keys of the drum kit will use the **Pan** (4-1c) setting.

---

**▼ 4-1: Page Menu Commands**

The number before each command shows its ENTER + number-key shortcut. For more information on these shortcuts, see “ENTER + 0-9: shortcuts for menu commands” on page 147.

- 0: **Write Program.** For more information, see “Write Program” on page 147.
- 1: **Exclusive Solo.** For more information, see “Exclusive Solo” on page 147.
- 2: **Copy Oscillator.** For more information, see “Copy Oscillator” on page 153.
- 3: **Swap Oscillators.** For more information, see “Swap Oscillator” on page 153.



## 4-2: Amp1 Modulation

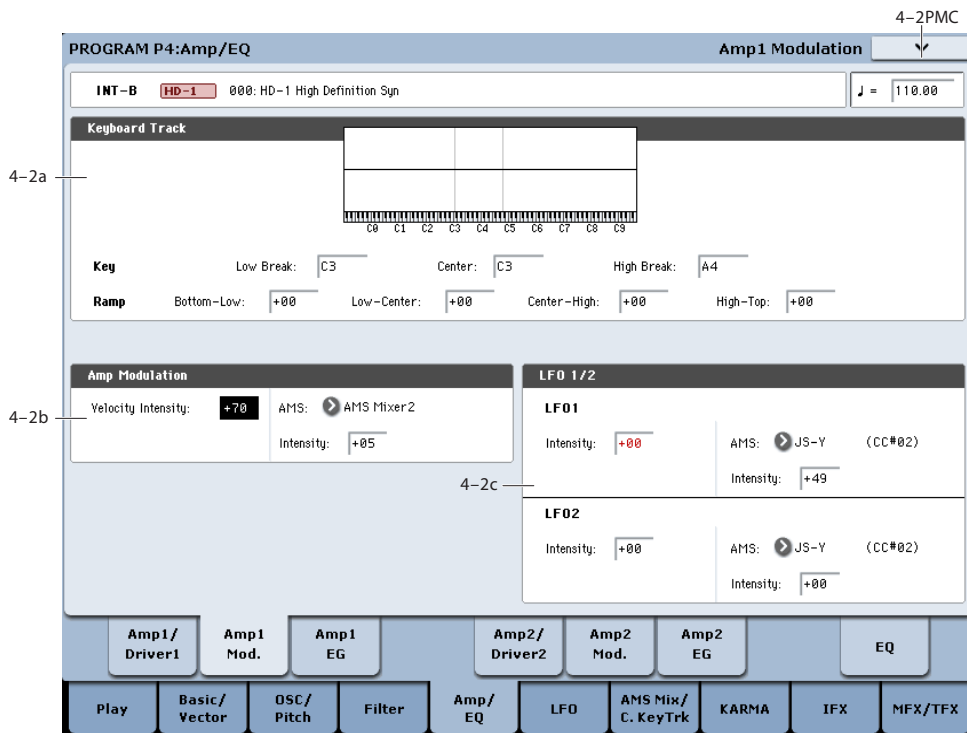

This page contains the settings for Oscillator 1’s Amp level modulation. Among other things, you can:

- Set up complex keyboard tracking shapes to control the Amp level.
- Assign AMS modulation for the Amp level.
- Control the effect of the LFOs on the Amp level.

The total effects of the modulation can increase the volume to a maximum of two times louder than the Amp Level setting.

### 4-2a: Keyboard Track AMSsource

Keyboard tracking lets you vary the volume as you play up and down the keyboard. Usually, some amount of key tracking is necessary in order to make the volume consistent across the entire range.

KRONOS’s keyboard tracking can be fairly complex, if desired. You can create different rates of change over up to four different parts of the keyboard. For instance, you can:

- Make the volume increase very quickly over the middle of the keyboard, and then increase more slowly—or not at all—in the higher octaves.
- Make the volume increase as you play *lower* on the keyboard.
- Create abrupt changes at certain keys, for split-like effects.

### How it works: Keys and Ramps

The keyboard tracking works by creating four ramps, or slopes, between five keys on the keyboard. The bottom and top keys are fixed at the bottom and top of

the MIDI range, respectively. You can set the other three keys—named Low Break, Center, and High Break—to be anywhere in between.

The four Ramp values control the rate of change between each pair of keys. For instance, if the Low-Center Ramp is set to 0, the value will stay the same between the Low Break key and the Center key.

You can think of the resulting shape as being like two folding doors attached to a hinge in the center. At the Center key (the main hinge), the keyboard tracking has no effect. The two folding doors swing out from this center point to create changes in the higher and lower ranges of the keyboard.

### Key

**Low Break** [C-1...G9]

This sets the breakpoint note between the two lower ramps - the “hinge” of the lower door.

**Center** [C-1...G9]

This sets the center of the keyboard tracking - the main “hinge.” At this key, the keyboard tracking has no effect on the volume, or on any AMS destinations.

**High Break** [C-1...G9]

This sets the breakpoint note between the two higher ramps - the “hinge” of the upper door.

### Entering notes from the keyboard

You can enter note numbers directly by playing them on the keyboard. To do so:

1. Select one of the Key parameters.
2. Hold down the ENTER key.



3. While holding ENTER, play a note on the keyboard.

**Ramp**

Positive ramp values mean that the keyboard tracking output increases as you play farther from the Center Key; negative ramp values mean that it decreases.

Because of this, the meanings of positive and negative ramp settings will change depending on whether the ramp is to the left or right of the Center Key.

**Bottom-Low and Low-Center:** negative ramps make the keyboard tracking's output go down as you play lower on the keyboard, and positive ramps make the output go higher.

**Center-High and High-Top:** negative ramps make the keyboard tracking's output go down as you play *higher* on the keyboard, and positive ramps make the output go up.

**Differences from other Keyboard Tracks**

There are several differences between the Amp keyboard tracking and the Filter and Common keyboard tracking.

For example, the results of the Ramp values are different. As shown in the graphic "Amp Keyboard Tracking," below, negative slopes are more steep than positive slopes.

Also, the amp does not have separate control of Intensity. Instead, Intensity is always fixed at the maximum amount, allowing keyboard tracking to change the volume from complete silence to twice as loud as the programmed level.

**Bottom-Low** [-Inf, -99...+99, +Inf]

This sets the slope between the bottom of the MIDI note range and the Low Break key. For normal key track, use negative values.

**Low-Center** [-Inf, -99...+99, +Inf]

This sets the slope between the Low Break and Center keys. For normal key track, use negative values.

**Center-High** [-Inf, -99...+99, +Inf]

This sets the slope between the Center and High Break keys. For normal key track, use positive values.

**High-Top** [-Inf, -99...+99, +Inf]

This sets the slope between the High Break key and the top of the MIDI note range. For normal key track, use positive values.

Ramp	Change in level
-Inf	Silent in one half-step
-99	Silent in one whole-step
-95	Silent in one octave
-48	Silent in two octaves
-25	Silent in four octaves
00	no change
+25	x2 in four octaves
+50	x2 in two octaves
+99	x2 in one octave
+Inf	x2 in one half-step

**+Inf and -Inf ramps**

+Inf and -Inf are special settings which create abrupt changes for split-like effects. When a ramp is set to +Inf or -Inf, the keyboard tracking will go to its extreme highest or lowest value over the span of a single key.

When a ramp is set to +Inf, the keyboard tracking will go to its highest value (double the programmed volume) over a single half-step.

Similarly, when a ramp is set to -Inf, the keyboard tracking will go to its lowest value (complete silence) over a single half-step.

*Note:* if you set the Center-High ramp to +Inf or -Inf, the High-Top parameter will be grayed out. Similarly, if you set the Low-Center ramp to +Inf or -Inf, the Bottom-Low ramp will be grayed out.

Amp Keyboard Tracking

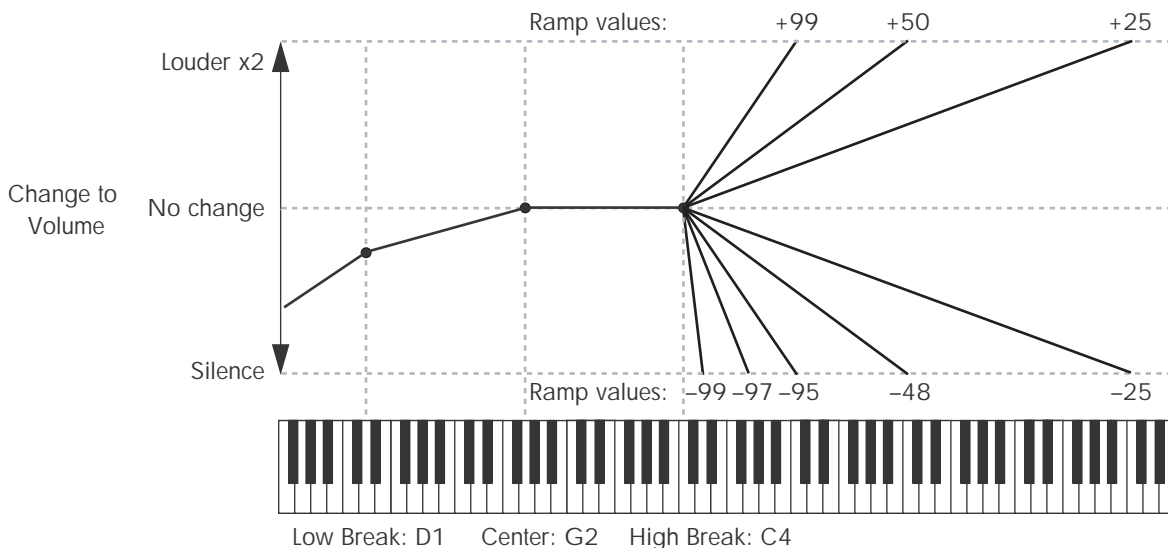

## Amp Keytrack is also an AMS source

You can use the keyboard tracking as an AMS source to modulate other parameters, just like the envelopes and LFOs. Simply select Amp Keytrack in the AMS list for the desired parameter.

### 4-2b: Amp Modulation

You can modulate the Amp level by both velocity and an AMS source.

This modulation scales the basic Amp level and Amp EG level parameters. The resulting volume is determined by multiplying the volume changes of the amp EG by other values such as AMS. If these original levels are low, the maximum volume available with modulation will also be reduced.

#### Velocity Intensity [-99...+99]

With **positive (+)** values, the volume will increase as you play harder.

With **negative (-)** values, the volume will decrease as you play harder.

*Velocity modulation of Amp level, with Amp EG*

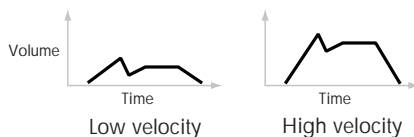

#### AMS [List of AMS Sources]

This selects any AMS modulation source to control the Amp level. For a list of AMS sources, see “Alternate Modulation Source (AMS) List” on page 1091.

#### Intensity [-99...+99]

This controls the depth and direction of the modulation.

For example, if **AMS** is set to After Touch, **positive (+)** values of this parameter will make the volume increase when you press down on the keyboard.

Note that if the other modulation settings have already raised the volume to its maximum level (double the Amp Level and Amp EG level settings), the volume cannot be increased any further.

With **negative (-)** values of this parameter, the volume will decrease when pressure is applied to the keyboard.

### 4-2c: LFO 1/2

You can modulate the Amp level with both LFO1 and LFO2.

#### LFO1

#### Intensity (LFO1) [-99...+99]

This controls the depth and direction of LFO1’s effect on the oscillator’s volume.

**Negative (-)** values will invert the LFO waveform.

#### AMS (LFO1) [List of AMS Sources]

This selects an AMS modulation source to scale the amount of the LFO1 applied to the Amp level.

For a list of AMS sources, see “Alternate Modulation Source (AMS) List” on page 1091.

#### Intensity [-99...+99]

This controls the depth and direction of the LFO1 AMS modulation for the Amp level.

For example, if **AMS** is set to **After Touch**, **positive** settings mean that aftertouch will increase the amount of LFO1 applied to the Amp level.

#### LFO2

The parameters for LFO2 are identical to those for LFO1. For more information, see the descriptions under LFO1, above.

### ▼ 4-2: Page Menu Commands

The number before each command shows its ENTER + number-key shortcut. For more information on these shortcuts, see “ENTER + 0-9: shortcuts for menu commands” on page 147.

- **0: Write Program.** For more information, see “Write Program” on page 147.
- **1: Exclusive Solo.** For more information, see “Exclusive Solo” on page 147.
- **2: Copy Oscillator.** For more information, see “Copy Oscillator” on page 153.
- **3: Swap Oscillators.** For more information, see “Swap Oscillator” on page 153.

## 4-3: Amp1 EG AMSSource

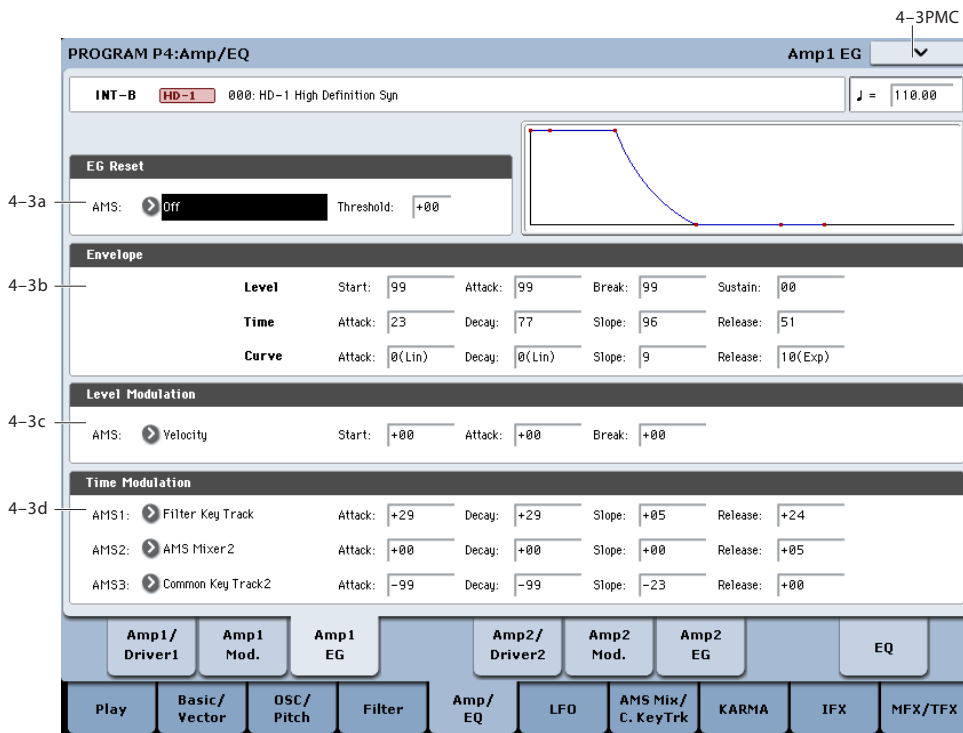

These parameters let you create time-varying changes in the volume of oscillator 1.

### 4-3a: EG Reset

#### AMS (EG Reset) [List of AMS Sources]

This selects an AMS source to reset the EG to the start point. For instance, you can use a tempo-synced LFO to trigger the EG in a repeating rhythm. This reset is in addition to the initial note-on, which always causes the EG to start.

*Note:* Once the Amp EG is in its Release segment, it cannot be reset. (Otherwise, the sound might keep playing forever!)

For a list of AMS sources, see “Alternate Modulation Source (AMS) List” on page 1091.

#### Threshold [−99...+99]

This sets the AMS level which will trigger the EG reset. Among other things, you can use this to adjust the exact point in an LFO’s phase at which the EG will be reset, effectively controlling its “groove” against other rhythmic effects.

When the threshold is **positive**, the EG triggers when passing through the threshold moving upwards. When the threshold is **negative**, the EG triggers when passing through the threshold moving downwards.

**Note:** with some LFO shapes, and with faster LFO speeds, the LFO may not always reach the extreme values of +99 or -99. In this case, setting the **Threshold** to these values may cause inconsistent behavior, or may mean that the EG doesn’t reset at all. If this happens, reduce the **Threshold** until the EG triggers consistently.

### 4-3b: Envelope

These parameters specify how the amp 1 EG will change over time.

*Amp EG*

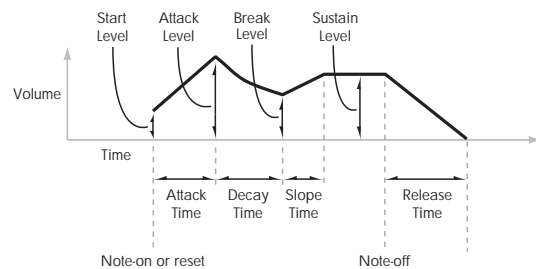

#### Level

#### Start [00...99]

This sets the initial volume level at note-on.

#### Attack [00...99]

This sets the level at the end of the Attack time.

#### Break [00...99]

Break, short for Break Point, sets the level at the end of the Decay time.

#### Sustain [00...99]

This sets the level at the end of the Slope time. Once it reaches the Sustain level, the EG will stay there until note-off (unless it is reset via AMS).

**Time**

Higher values mean longer times, as shown below.

EG Value	Actual Time
00	0.667 ms
10	10 ms
20	44 ms
30	104 ms
40	224 ms
50	464 ms
60	944 ms
70	1.8 seconds
80	3.8 seconds
90	10.9 seconds
99	87.3 seconds

**Attack** [00...99]

This sets how long the EG takes to move from the Start level to the Attack level.

The minimum attack time is 2/3 of a millisecond—as fast as the most punchy of classic analog synths.

For the fastest possible attack time, you can set the Start level to +99; in this case, the EG will start instantaneously at its maximum value.

**Decay** [00...99]

This sets the time it takes to move from the Attack level to the Break level.

**Slope** [00...99]

This sets how long the EG takes to move from the Break level to the Sustain level. Once it reaches the Sustain level, the EG will stay there until note-off (unless it is reset via AMS).

**Release** [00...99]

This sets how long it takes the EG to move from the Sustain level to silence.

**Curve**

For the sake of simplicity, most of the diagrams in this manual show envelopes as being made out of straight lines. In actuality, though, envelopes are more likely to be made out of curves.

In other words, each segment’s level will change quickly at first, and then slow down as it approaches the next point. This tends to sound better than straight, linear segments.

Classic analog synth envelopes made these curved shapes naturally. The KRONOS goes a step further than vintage synths, however, and lets you control the amount of curvature separately for each of the four envelope segments.

When you change the curvature, the EG times remain the same. However, greater curvature will tend to sound faster, because the value changes more quickly at the beginning.

*Amp EG Curve*

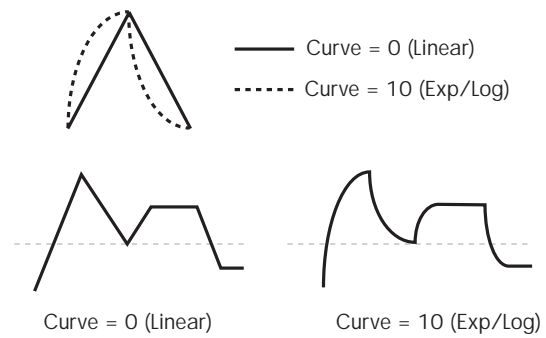

**Different curve settings for up and down**

You may find that different amounts of curvature are suitable for segments which go up and segments which go down.

For instance, a curve of 3 is a good default setting for upward segments, such as Attack. On the other hand, a curve of 6 or more is good for downward segments, such as Decay and Release.

**Attack** [0 (Linear), 1...9, 10 (Exp/Log)]

This sets the curvature of the Attack segment - the transition from the Start level to the Attack level.

**Decay** [0 (Linear), 1...9, 10 (Exp/Log)]

This sets the curvature of the Decay segment - the transition from the Attack level to the Break level.

**Slope** [0 (Linear), 1...9, 10 (Exp/Log)]

This sets the curvature of the Slope segment - the transition from the Break level to the Sustain level.

**Release** [0 (Linear), 1...9, 10 (Exp/Log)]

This sets the curvature of the Release segment - the transition from the Sustain level to the Release level.

**4-3c: Level Modulation**

These settings let you use any AMS source to control the Level parameters of the EG. The Start, Attack, and Break levels share a single AMS source, but can each have different modulation intensities.

By using different settings for each of the three levels, you can cause both subtle and dramatic changes to the EG shape, as shown below.

*Amp EG Level Modulation*

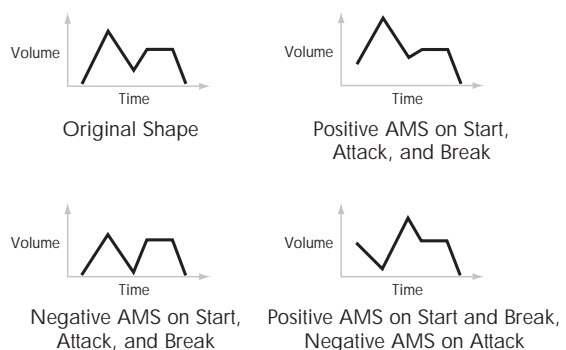

**Once an EG segment begins, it can't be modulated**

Once the EG has started a segment between two points, that segment can no longer be modulated. This includes both the time of the segment, and the level reached at the end of the segment.

For more information, see "Once an EG segment begins, it can't be modulated" on page 79.

**AMS [List of AMS Sources]**

This selects an AMS source to control the EG's Level parameters.

For a list of AMS sources, see "Alternate Modulation Source (AMS) List" on page 1091.

**Start [-99...+99]**

This controls the depth and direction of the AMS modulation for the Start level.

For example, if you set the AMS source to Velocity and set Start to +99, the Start level will increase as you play harder. If you instead set Start to -99, the Start level will decrease as you play harder.

**Attack [-99...+99]**

This controls the depth and direction of the AMS modulation for the Attack level.

**Break [-99...+99]**

This controls the depth and direction of the AMS modulation for the Break level.

**4–3d: Time Modulation**

These settings let you use three different AMS sources to control the Time parameters of the EG. For each of the three AMS sources, the Attack, Decay, Slope, and Release times each have their own modulation intensities.

*Amp EG Time Modulation*

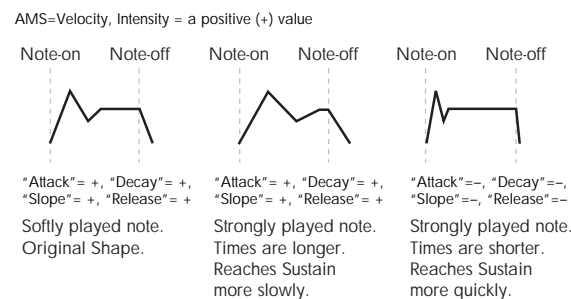

**4–5: Amp2/Driver2**

This page controls Oscillator 2's basic level, pan, and driver settings. It is available only when the **Oscillator Mode** is set to **Double**; if not, the page will be grayed out.

**AMS1 [List of AMS Sources]**

Selects the first AMS source to control the EG's Time parameters. Velocity and Keyboard Track can both be useful here, for instance.

For a list of AMS sources, see "Alternate Modulation Source (AMS) List" on page 1091.

**Attack [-99...+99]**

This controls the depth and direction of the AMS modulation for the Attack time.

For example, if you set the AMS source to Velocity and set Attack to +99, the Attack time will get much longer at higher velocities. If you instead set Attack to -99, the Attack time will get much shorter at higher velocities.

When the AMS source is at its maximum value—for instance, when Velocity is at 127—a setting of +8 will make the segment time almost twice as long, and a setting of -8 will cut the segment time almost in half.

**Decay [-99...+99]**

This controls the depth and direction of the AMS modulation for the Decay time.

**Slope [-99...+99]**

This controls the depth and direction of the AMS modulation for the Slope time.

**Release [-99...+99]**

This controls the depth and direction of the AMS modulation for the Release time.

**AMS2 and AMS3**

These select the second and third AMS sources, respectively, for controlling the EG's Time parameters. Each has its own intensities for Attack, Decay, Slope, and Release. The parameters of both AMS2 and AMS3 are identical to those of AMS1, above.

**▼ 4–3: Page Menu Commands**

The number before each command shows its ENTER + number-key shortcut. For more information on these shortcuts, see "ENTER + 0-9: shortcuts for menu commands" on page 147.

- 0: **Write Program**. For more information, see "Write Program" on page 147.
- 1: **Exclusive Solo**. For more information, see "Exclusive Solo" on page 147.
- 2: **Copy Oscillator**. For more information, see "Copy Oscillator" on page 153.
- 3: **Swap Oscillators**. For more information, see "Swap Oscillator" on page 153.
- 4: **Sync Both EGs**. For more information, see "Sync Both EGs" on page 155.

The parameters are identical to those for Oscillator 1, as described under "4–1: Amp1/Driver1," on page 82.

## 4-6: Amp2 Mod.

This page controls Oscillator 2's amp modulation. It is available only when the **Oscillator Mode** is set to **Double**; if not, the page will be grayed out.

The parameters are identical to those for Oscillator 1, as described under "4-2: Amp1 Modulation," on page 84.

## 4-7: Amp2 EG AMSource

This page controls Oscillator 2's amp EG. It is available only when the **Oscillator Mode** is set to **Double**; if not, the page will be grayed out.

The parameters are identical to those for Oscillator 1, as described under "4-3: Amp1 EG," on page 87.

## 4-9: EQ

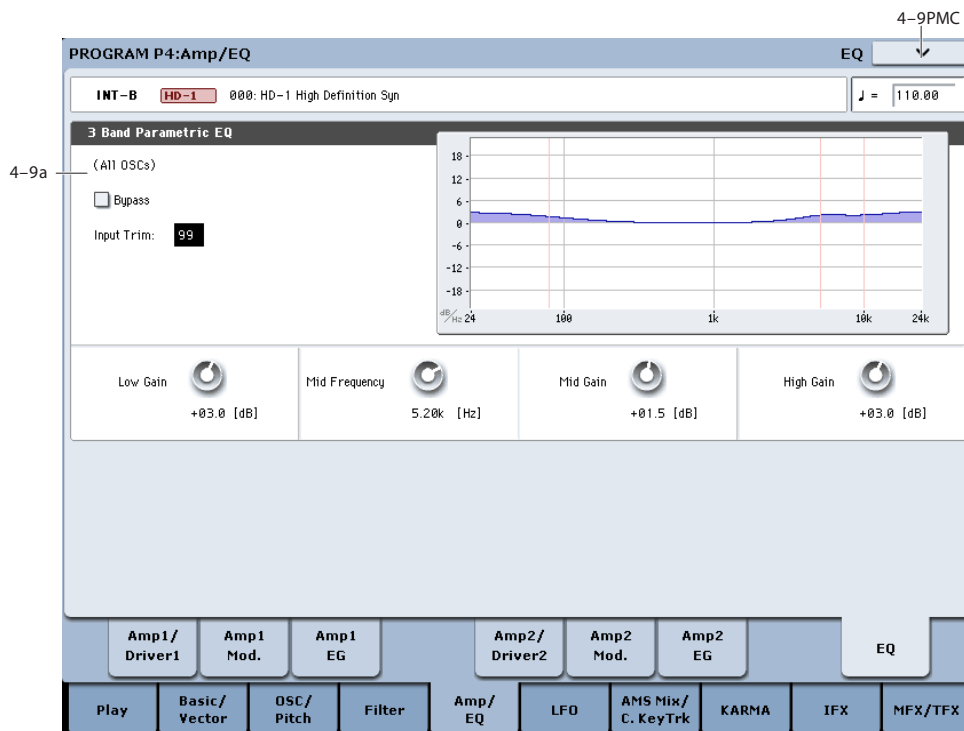

This three-band EQ, with sweepable mid, is shared by both of the Program's oscillators. The Drum Track has its own EQ: for more information, see "1-3e: EQ" on page 44.

In Combis and Sequences, each timbre and track has its own individual EQ. You can import the Program's EQ settings into Tracks and Timbres by using the Combi and Sequence "Auto-Load Program EQ" options.

### 4-9a: 3 Band Parametric EQ

In addition to using the on-screen parameters, you can also use the front-panel Control Surface to set up most of the EQ parameters (everything except for Bypass). To do so:

1. Press the Control Surface Timbre/Track button.
2. Set the MIXER KNOBS switch to Channel Strip.
3. Set the Trim, Low Gain, Mid Freq, Mid Gain, and High Gain using the knobs.

### Bypass [On, Off]

When Bypass is checked, all of the EQ will be disabled, including the Input Trim.

Bypass can be convenient for comparing the results of the EQ with the original signal.

### Input Trim [00...99]

This controls the volume level going into the EQ.

High settings of the Low, Mid, and High Gain controls can cause substantial increases in the overall level. You can compensate for this by turning down the input trim.

### Low Gain [-18.0...+18.0dB]

This controls the gain of the 80Hz Low Shelf EQ, in increments of 0.5dB.

### Mid Frequency [100Hz...10.00kHz]

This sets the center frequency for the Mid sweep EQ.

**Mid Gain** [-18.0...+18.0dB]

This controls the gain of the Mid Sweep EQ, in increments of 0.5dB.

**High Gain** [-18.0...+18.0dB]

This controls the gain of the 10kHz High Shelf EQ, in increments of 0.5dB.

---

**▼ 4-9: Page Menu Commands**

The number before each command shows its ENTER + number-key shortcut. For more information on these shortcuts, see "ENTER + 0-9: shortcuts for menu commands" on page 147.

- 0: **Write Program**. For more information, see "Write Program" on page 147.
- 1: **Exclusive Solo**. For more information, see "Exclusive Solo" on page 147.
- 2: **Copy Oscillator**. For more information, see "Copy Oscillator" on page 153.
- 3: **Swap Oscillators**. For more information, see "Swap Oscillator" on page 153.



## Program P5: LFO

Each of the Oscillators has two LFOs, which you can use to modulate the filter, amp, pitch, and many other parameters.

The two Oscillators also share a single Common LFO, similar to the global LFO on some vintage analog synths.

These pages let you set up all of the parameters for all five LFOs.

### 5-1: OSC1 LFO1 AMSource

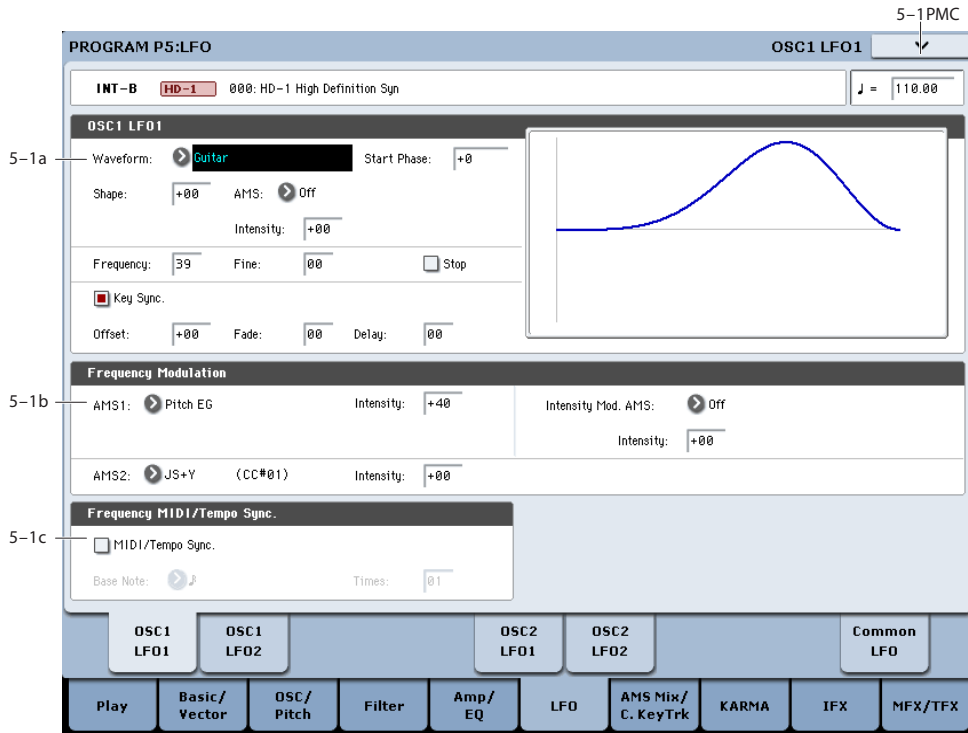

This page has all of the controls for the first LFO of Oscillator 1. For instance, you can:

- Select the LFO's basic waveform, and modify it with the Shape parameter.
- Control the LFO's frequency, and assign AMS controllers to modulate the frequency.
- Use the Key Sync parameter to choose whether the LFO runs separately for each voice, or is synchronized across all of the voices
- Use the Fade and Delay parameters to control how long the LFO waits to start after note-on, and whether it starts abruptly or fades in slowly.
- Set the LFO to sync to MIDI tempo.

#### 5-1a: OSC 1 LFO 1

##### Waveform [Triangle...Random6 (Continuous)]

This selects the basic LFO waveform, as shown in the graphic below.

Most of the waveforms should be self-explanatory, but a few will benefit from more details:

**Guitar** is intended for guitar vibrato, and its shape is specifically tuned for this purpose. The waveform is positive-only, so that when used for pitch, it will only bend up, and not down.

**Random1 (S/H)** generates traditional sample and hold waveforms, in which the level changes randomly at fixed intervals of time.

#### LFO Waveforms

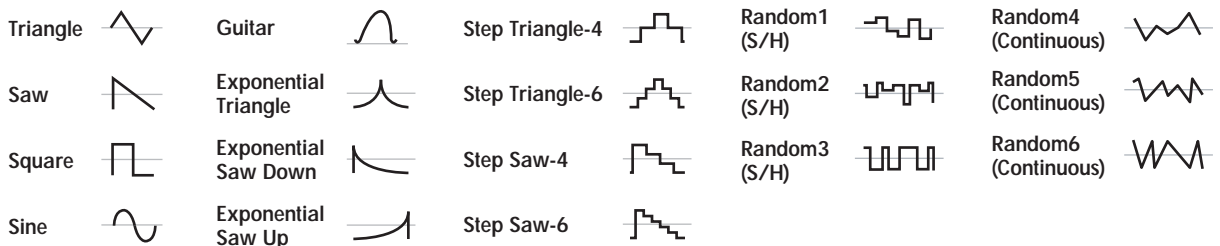

**Random2 (S/H)** randomizes both the levels and the timing.

**Random3 (S/H)** generates a pulse wave with random timing. It's the opposite of traditional sample and hold; the timing varies, but the levels don't.

**Random4-6 (Continuous)** are smoothed versions of Random 1-3, with ramps instead of steps. You can use them to create more gentle random variations.

**Start Phase** [-180...+180, Random]

This controls the phase of the waveform at the start of the note, in steps of 5 degrees.

If **Key Sync** is Off, the Start Phase will apply only to the first note of the phrase.

**Shape** [-99...+99]

Shape adds curvature to the basic waveform. As you can see in the graphic below, this can make the waveforms either more rounded or more extreme. It can also be useful to emphasize certain value ranges, and de-emphasize others.

For example, let's say that you are using a triangle LFO to modulate filter cutoff. If Shape emphasizes the high value range, the filter will spend more time at the higher frequencies. If it emphasizes the low range, the filter will spend more time at the lower frequencies.

LFO Shape

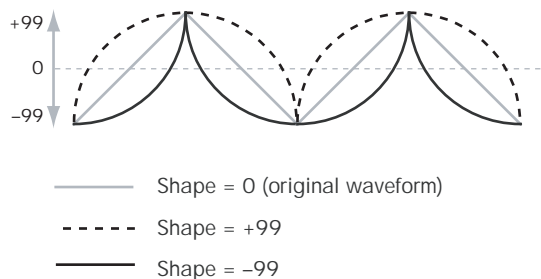

*Note:* Shape does **not** affect the Square and Random 3 waveforms, since their values are always either +99 or -99. When these are selected, Shape is grayed out.

**AMS (Shape)** [List of AMS Sources]

This selects a modulation source for controlling the LFO's Shape. Modulating the shape can dramatically alter the effect of the LFO—try it out!

For a list of AMS sources, see "Alternate Modulation Source (AMS) List" on page 1091.

**Intensity** [-99...+99]

This controls the depth and direction of the Shape modulation.

**Frequency** [00...99]

This controls the speed of the LFO, before any modulation. Higher values mean faster speeds, as shown in the table below.

By using AMS modulation, you can also get speeds much faster and much slower than are available through this basic setting.

Frequency Value	Frequency in Hz
00	0.014 Hz
10	0.112 Hz
20	0.422 Hz
30	0.979 Hz
40	1.79 Hz
50	2.84 Hz
60	4.14 Hz
70	5.69 Hz
80	7.49 Hz
90	9.53 Hz
99	26.25 Hz
99 + Fine 99	32 Hz

**Frequency Fine** [00...99]

This allows you to control the LFO frequency with greater precision, giving you 98 additional steps for each step of the main Frequency parameter.

When this is set to 00, the LFO speed is as set by the Frequency parameter.

When this is set to 99, it's the same as increasing the main Frequency value by 1.

**Stop** [Off, On]

**On (checked):** When Stop is On, the LFO does not advance normally, and the Frequency parameters are ignored. Instead, the LFO simply generate its very first value (as determined by the combination of the **Waveform, Start Phase, Shape, and Offset**), and then holds that value until the end of the note.

You can use this in conjunction with the Random waveforms to create static, random modulation, with the value changing only at note-on.

**Off (unchecked):** When Stop is Off, the LFO will function normally.

**Key Sync** [Off, On]

**On (checked):** When Key Sync is On, the LFO starts each time you press a key, and an independent LFO runs for each note. This is the normal setting.

**Off (unchecked):** When Key Sync is Off, the LFO starts from the phase determined by the first note in the phrase, so that the LFOs for all notes being held are synchronized together. The Fade and Delay settings will only apply to the first note's LFO.

Note that even if Key Sync is Off, each note's LFO speed may still be different if you modulate the Frequency by note number, velocity, key scaling, or other note-specific AMS sources.

**Offset** [-99...+99]

By default, almost all of the LFO waveforms are centered around 0, and then swing all the way from -99 to +99. This parameter lets you shift the LFO up and down, so that—for instance—it's centered on 50, and then swings from -49 to +149.

For example, let's say that you're using an LFO for vibrato. If the Offset is 0, the vibrato will be centered on the note's original pitch, bending it both up and down.

If the Offset is +99, on the other hand, the vibrato will only raise the pitch above the original note.

*Offset settings and pitch change produced by vibrato*

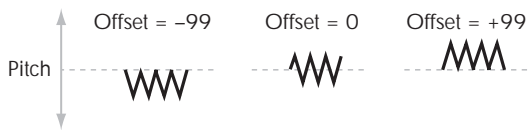

The one exception to this is the Guitar waveform, which is designed to emulate bending a string on a guitar—so that the pitch only goes up, and not down. Because of this, the waveform is centered on 50, and not on 0. Of course, you can always use a negative Offset to shift it back down below 0 again!

Since Offset affects the output values of the LFO, it's important to note that it affects the signal *after* the Shape function, as shown below:

*LFO Signal Flow*

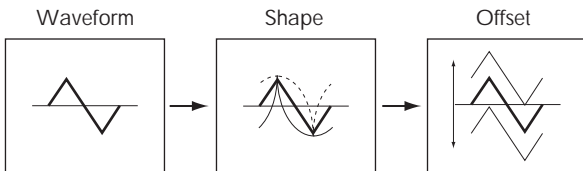

**Fade** [00...99]

The LFO can fade in gradually, instead of simply starting immediately at full strength. This parameter specifies the time from when the LFO begins to play until it reaches its maximum amplitude.

If the Delay parameter is being used, then the fade will begin after the delay is complete.

When **Key Sync** is **Off**, the fade will apply only to the first note in the phrase.

*LFO Fade and Delay*

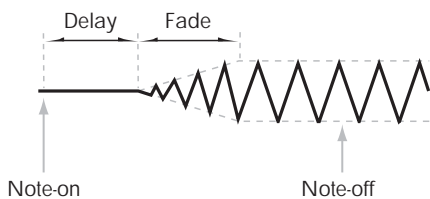

**Delay** [00...99]

This sets the time from note-on until the LFO starts.

When **Key Sync** is **Off**, the delay applies only to the first note of the phrase.

**5-1b: Frequency Modulation**

You can use two alternate modulation sources (AMS) to adjust the speed of the LFO.

**AMS1 (Frequency)** [List of AMS Sources]

This selects the first modulation source for the LFO's frequency. For a list of AMS sources, see "Alternate Modulation Source (AMS) List" on page 1091.

Note that you can use LFO2 to modulate LFO1's frequency.

**Intensity** [-99...+99]

This sets the initial amount of AMS1. The Intensity Mod AMS then adds to this initial amount.

When AMS1 is at its maximum value (for instance, when the joystick is pushed all the way up), the AMS affects the frequency as shown below:

Intensity	Change to LFO Frequency	
+99	64x	Faster
+82	32x	
+66	16x	
+49	8x	
+33	4x	
+16	2x	Slower
-16	1/2x	
-33	1/4x	
-49	1/8x	
-66	1/16x	
-82	1/32x	
-99	1/64x	

**Intensity Mod AMS** [List of AMS Sources]

This selects a secondary AMS modulation source to scale the intensity of AMS1.

For a list of AMS sources, see "Alternate Modulation Source (AMS) List" on page 1091.

**Intensity** [-99...+99]

This controls the depth and direction of the Intensity Mod AMS. Even if the main AMS1 Intensity is set to 0, Intensity Mod AMS can still control the final amount of AMS A over the full +/-99 range.

For example, if **AMS1** is set to the **Pitch EG**, and **Intensity Mod AMS** is set to **After Touch**, **positive** settings mean that aftertouch will increase the intensity of the Pitch EG modulation of LFO Frequency.

**AMS2 (Frequency)** [List of AMS Sources]

This selects the second modulation source for the LFO's frequency. For a list of AMS sources, see "Alternate Modulation Source (AMS) List" on page 1091.

**Intensity** [-99...+99]

This controls the amount of modulation from AMS2.

## 5-1c: Frequency MIDI/Tempo Sync

### MIDI/Tempo Sync [Off, On]

**On (checked):** The LFO will synchronize to the system tempo, as set by either the Tempo knob or MIDI Clock. The LFO speed will be controlled by the **Base Note** and **Times** parameters, below. All settings for **Frequency** and **Frequency Modulation** will be ignored.

**Off (unchecked):** The Frequency settings will determine the speed of the LFO, and the tempo settings will have no effect.

### Base Note [♪... ♩]

This sets a basic rhythmic value for the LFO speed, relative to the system tempo. The values range from a 32nd note to a whole note, including triplets. It applies only when **MIDI/Tempo Sync** is **On**.

### Times [01...32]

This multiplies the length of the **Base Note**. For instance, if the **Base Note** is set to a sixteenth note, and **Times** is set to 3, the LFO will cycle over a dotted eighth note.

## ▼ 5-1: Page Menu Commands

The number before each command shows its ENTER + number-key shortcut. For more information on these shortcuts, see “ENTER + 0-9: shortcuts for menu commands” on page 147.

- 0: **Write Program**. For more information, see “Write Program” on page 147.
- 1: **Exclusive Solo**. For more information, see “Exclusive Solo” on page 147.
- 2: **Swap LFO 1 & 2**. For more information, see “Swap LFO 1&2” on page 155.

## 5-2: OSC1 LFO2 AMSOURCE

This is Oscillator 1’s second LFO. Its parameters are exactly the same as those for the first LFO, as described under “5-1: OSC1 LFO1” on page 92—except that LFO1 cannot modulate LFO2.

## 5-5: OSC2 LFO1 AMSOURCE

This page controls Oscillator 2’s first LFO. It is available only when the **Oscillator Mode** is set to **Double**; if not, the page will be grayed out.

The parameters are identical to those for Oscillator 1, as described under “5-1: OSC1 LFO1” on page 92.

## 5-6: OSC2 LFO2 AMSOURCE

This page controls Oscillator 2’s second LFO. It is available only when the **Oscillator Mode** is set to **Double**; if not, the page will be grayed out.

Its parameters are exactly the same as those for the first LFO, as described under “5-1: OSC1 LFO1” on page 92—except that LFO1 cannot modulate LFO2.

## 5-9: Common LFO AMSource

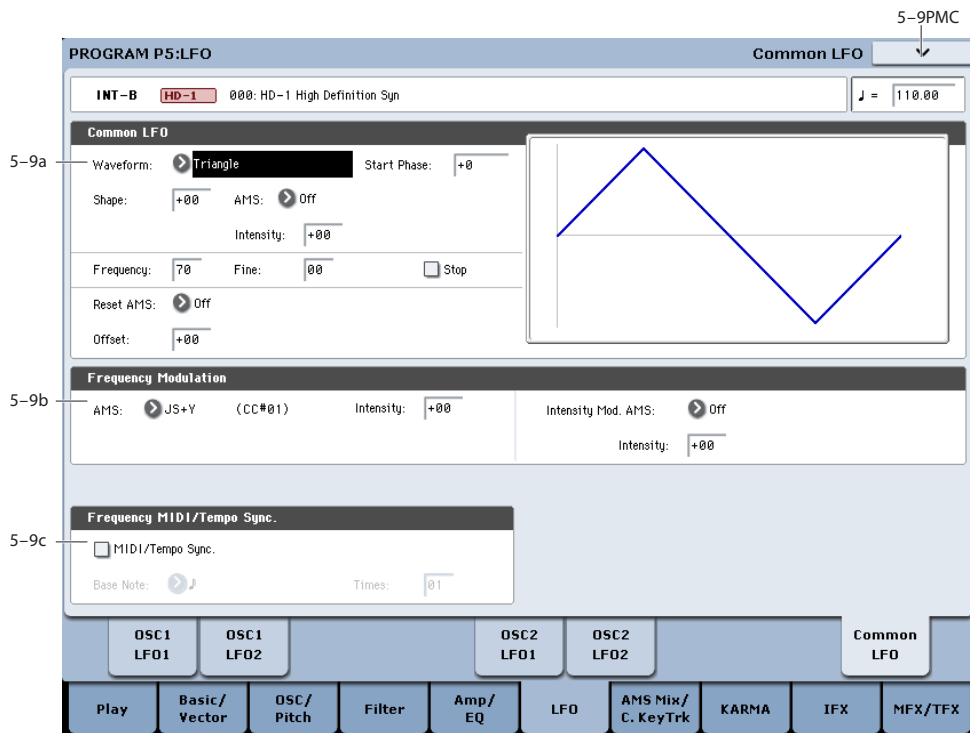

This is a single, free-running LFO, global for all voices in the Program—like the modulation LFOs in some vintage analog synths.

### Differences from LFO1/2

The Common LFO starts running as soon as you select the Program, and only resets when you tell it to do so explicitly via the Reset Source control, below. This is different from LFO1/2's Key Sync parameter, which resets whenever all notes are released.

The Common LFO's persistence can be handy if you want to create a constant rhythm with an LFO, and then play "underneath" that rhythm without re-triggering it. For instance, you can use a MIDI controller in your sequencer to reset the Common LFO every few bars, regardless of what notes are being played.

The Common LFO has most of the same controls as LFO1/2. However, it does not include the Delay, Fade, and Key Sync settings, since these only make sense for per-voice LFOs.

## 5-9a: Common LFO

### Waveform [Triangle...Random6 (Continuous)]

This selects the basic LFO waveform. For a complete list of the waveforms and more details, please see the entry under LFO1 "Waveform," on page 92.

### Start Phase [-180...+180, Random]

The Reset Source, described above, lets you reset the Common LFO. This is the phase from which the LFO will start when it is reset.

### Shape [-99...+99]

Shape adds curvature to the basic waveform. For more details, please see the entry under LFO1 "Shape," on page 93.

*Note:* Shape does **not** affect the Square and Random 3 waveforms, since their values are always either +99 or -99.

### AMS (Shape) [List of AMS Sources]

This selects a modulation source for controlling the LFO's Shape. Modulating the shape can dramatically alter the effect of the LFO—try it out!

For a list of AMS sources, see "Alternate Modulation Source (AMS) List" on page 1091.

### Intensity [-99...+99]

This controls the depth and direction of the Shape modulation.

### Frequency [00...99]

This controls the speed of the LFO, before any modulation. Higher values mean faster speeds. For a complete description, please see the entry under LFO1 "Frequency," on page 93.

### Frequency Fine [00...99]

This allows you to control the LFO frequency with greater precision, giving you 98 additional steps for each step of the main Frequency parameter.

When this is set to 00, the LFO speed is as set by the Frequency parameter.

When this is set to 99, it's the same as increasing the main Frequency value by 1.

**Stop** [Off, On]

**On (checked):** When Stop is **On**, the LFO does not advance, and the Frequency parameters are ignored. Instead, the LFO simply generate a single value when the Program is selected, and then holds that value until you select another Program, or until you reset the LFO via AMS.

*Note:* this is different from LFO1/2, in which the value is reset with every note-on.

You can use this in conjunction with the Random waveforms to create static, random modulation, with the value changing only when you first select the Program.

**Off (unchecked):** When Stop is **Off**, the LFO will function normally.

**Reset AMS** [List of AMS Sources]

This selects an AMS source to reset the LFO to the Start Phase. The LFO resets when the AMS value passes the halfway mark: +50 for most AMS sources, or 64 for MIDI controllers.

To create an effect similar to the per-voice LFO's **Key Sync Off** setting, set this to **Gate 1+ Damper**.

**Offset** [–99...+99]

By default, almost all of the LFO waveforms are centered around 0, and then swing all the way from –99 to +99. This parameter lets you shift the LFO up and down, so that—for instance—it's centered on 50, and then swings from –49 to +149.

For a complete description, please see the entry under LFO1 "Offset," on page 94.

---

**5–9b: Frequency Modulation**

These parameters are identical to the Frequency Modulation settings for LFO1, as described under "5–1b: Frequency Modulation," on page 94.

---

**5–9c: Frequency MIDI/Tempo Sync**

These parameters are identical to the Frequency MIDI/Tempo Sync for LFO1, as described under "5–1c: Frequency MIDI/Tempo Sync," on page 95.

---

**▼ 5–9: Page Menu Commands**

The number before each command shows its ENTER + number-key shortcut. For more information on these shortcuts, see "ENTER + 0-9: shortcuts for menu commands" on page 147.

- **0: Write Program.** For more information, see "Write Program" on page 147.
- **1: Exclusive Solo.** For more information, see "Exclusive Solo" on page 147.

## Program P6: AMS Mixer/Common Key Track

Each Oscillator has two AMS Mixers, which are simple but powerful tools for combining and modifying AMS signals.

The two Oscillators also share two Common keyboard tracking generators, in addition to the dedicated keyboard tracking for the Filter and Amp.

These pages let you control all of these modulation sources.

Note that when the **Oscillator Mode** is set to **Single**, only Oscillator 1's AMS Mixers are active; the pages for Oscillator 2 will be grayed out.

### 6-1: OSC 1 AMS Mixer

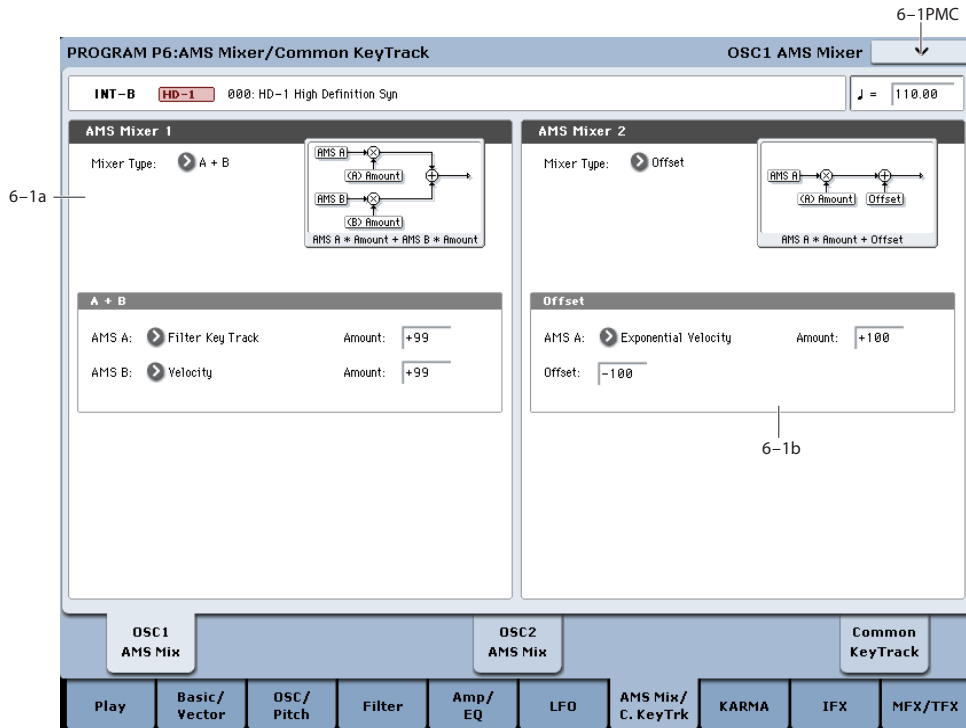

The AMS Mixers combine two AMS sources into one, or process an AMS source to make it into something new.

For instance, they can add two AMS sources together, or use one AMS source to scale the amount of another. You can also use them to change the shapes of LFOs and EGs in various ways, modify the response of realtime controllers, and more.

The AMS Mixer outputs appear in the list of AMS sources, just like the LFOs and EGs.

This also means that the original, unmodified inputs to the AMS Mixers are still available as well. For instance, if you use LFO 1 as an input to a AMS Mixer, you can use the processed version of the LFO to control one AMS destination, and the original version to control another.

Finally, you can cascade the two AMS Mixers together, by using AMS Mixer 1 as an input to AMS Mixer 2.

#### 6-1a: AMS Mixer 1 AMSource

**Mixer Type** [A+B, Amt Ax B, Offset, Smoothing, Shape, Quantize, Gate]

This controls the type of processing performed by AMS Mixer 1. Each of the Mixer Types is discussed in detail over the next several pages.

**A+B** adds two AMS sources together. For more information, see "A+B" on page 99.

**Amt Ax B** scales the amount of one AMS source with the other. See "Amt A x B" on page 99 for more details.

**Offset** adds or subtracts a constant value to or from an AMS source. For more information, see "Offset" on page 100.

**Smoothing** creates more gentle transitions between values, smoothing out abrupt changes such as a quick move on a joystick or a sharp edge on an LFO. For details, see "Smoothing" on page 101

**Shape** adds curvature to the AMS input. For an in-depth description, see "Shape" on page 101.

**Quantize** turns smooth transitions into discrete steps. See "Quantize" on page 102 for more information.



**Gate** chooses between two AMS inputs (or fixed values) based on a third AMS source. See “Gate” on page 103 for more information.

**A+B**

AMS Mixer, Type = A+B

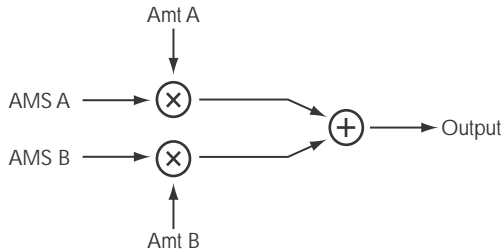

A+B merges two AMS sources into one. This can be handy when you need to add one more modulation source to a parameter, but you’ve already used up all of the available AMS slots.

For instance, let’s say that you’re using an LFO to modulate Filter Resonance, and then you decide that it would be interesting to scale that parameter with an EG as well. Resonance has only a single AMS input, but you can easily merge the LFO and the EG together using the A+B AMS Mixer:

1. Assign the LFO to AMS A.
2. Assign the EG to AMS B.
3. Assign the AMS Mixer as the Filter Resonance AMS source.

AMS Mixer A+B example

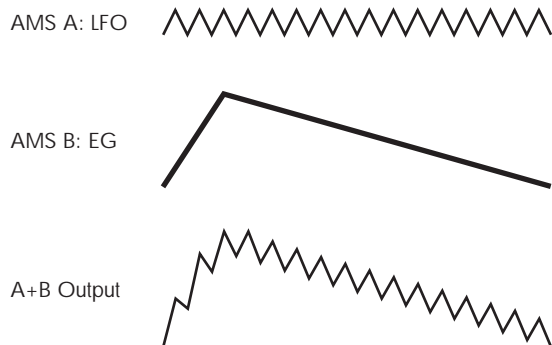

**AMS A** [List of AMS Sources]

This selects the first AMS input.

For a list of AMS sources, see “Alternate Modulation Source (AMS) List” on page 1091.

**AMS A Amount** [-99...+99]

This controls the depth and direction of the AMS A input.

**AMS B** [List of AMS Sources]

This selects the second AMS input.

For a list of AMS sources, see “Alternate Modulation Source (AMS) List” on page 1091.

**AMS B Amount** [-99...+99]

This controls the depth and direction of the AMS B input.

**Amt A x B**

AMS Mixer, Type = A x B

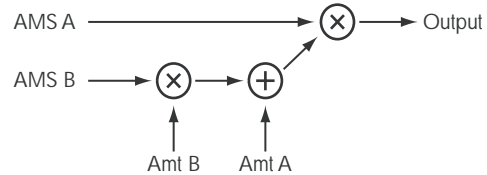

This Mixer Type uses AMS B to scale the amount of AMS A. For instance, you can control the amount LFO1 with the Filter EG, or control the amount of the Pitch EG with the ribbon.

AMS Mixer Amt AxB example

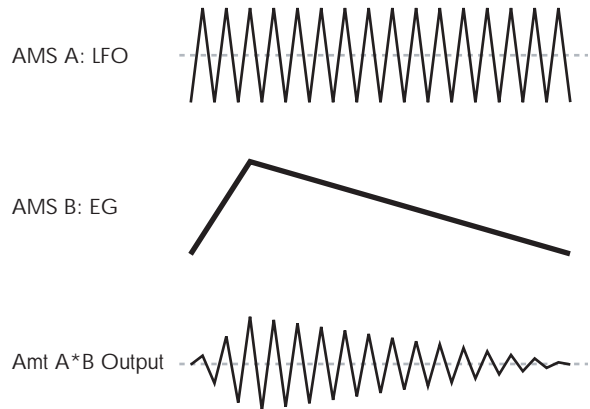

**AMS A** [List of AMS Sources]

This selects the first AMS source, which can then be scaled by AMS B. For a list of AMS sources, see “Alternate Modulation Source (AMS) List” on page 1091.

**AMS A Amount** [-99...+99]

This controls the initial amount of AMS A, before modulation from AMS B. Input from AMS B then adds to this initial amount.

Even if Amount A is set to 0, AMS B can still control the final amount of AMS A over the full +/-99 range.

**AMS B** [List of AMS Sources]

This selects the second AMS source, to scale the amount of AMS A. For a list of AMS sources, see “Alternate Modulation Source (AMS) List” on page 1091.

**AMS B Amount** [-99...+99]

This controls the depth and direction of the AMS B modulation of AMS A.

For example, if **AMS A** is set to LFO 1 and **AMS B** is set to the Filter EG, **positive** settings mean that the EG will increase the amount of LFO1.

### Tips for using Amt A x B

#### Using SW 1/2 to turn an AMS source on and off

You can use Amt AxB to “gate” an AMS source:

1. Set AMS A to the desired source, and set AMS A Amount to 0.
2. Set AMS B to SW 1 or 2, and AMS B Amount to +99.

Now, SW1 or 2 will turn AMS A on and off.

#### Muting individual Wave Sequence steps with SW1

You can use AMS Mixers in conjunction with the AMS outputs of Wave Sequences. For instance, you can use SW1 to turn one or more steps of a Wave Sequence on or off. To do this:

1. In the Oscillator which uses the Wave Sequence, set an AMS Mixer to Amt A\*B.
2. In the AMS Mixer, set AMS A to Wave Sequence AMS Output 2.

In the same AMS Mixer:

3. Set AMS B to SW1.
4. Set AMS A Amount to 0.
5. Set AMS B Amount to +99.

Now, SW1 will “gate” Wave Sequence AMS Output 2.

Next, in the Wave Sequence:

6. For the step(s) you'd like to mute, set the AMS Output 2 to +99.

Leave all other steps set to 00.

Back in the Oscillator which uses the Wave Sequence:

7. Set the Amp AMS source to the AMS mixer you set up in step 1, above.
8. Set the AMS Intensity to -99.

Now, when SW1 is On, the steps you set up in (6) will be muted.

When SW1 is Off, they'll sound normally.

### Offset

AMS Mixer, Type = Offset

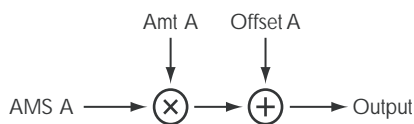

This simple processor adds a constant positive or negative offset to an AMS source, and also allows you to double the gain. Among other things, you can use this to convert a bipolar AMS source (both negative and positive) to a unipolar source (positive only), or vice-versa.

#### AMS A [List of AMS Sources]

This selects the AMS source to be offset.

For a list of AMS sources, see “Alternate Modulation Source (AMS) List” on page 1091.

### AMS Mixer Offset examples

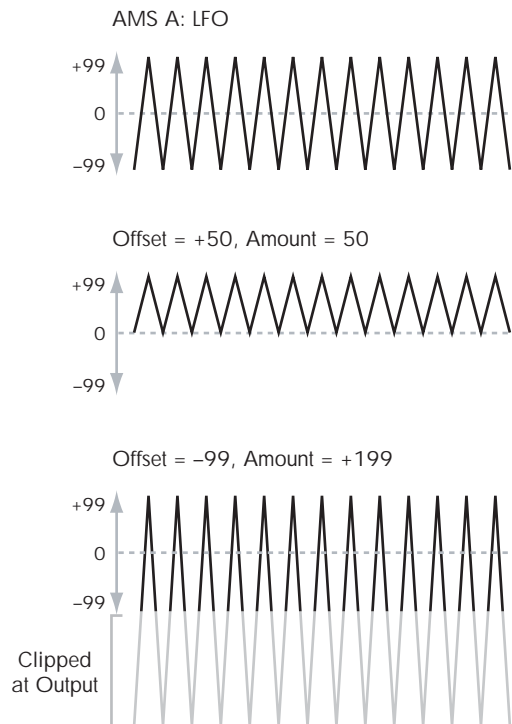

#### AMS A Amount [-199...+199]

This controls the basic level of AMS A.

+199 doubles the original signal level, while -199 doubles the level and inverts the phase. The values are clipped only at the output; internally, they can be greater than the normal range of -99 to +99.

#### AMS A Offset [-199...+199]

This controls the amount of offset for AMS A.

Setting Offset to +199 shifts an AMS input of -99 all the way to +99. In conjunction with high Amount values, this can be useful for creating clipped shapes, such as shown in the last of the “AMS Mixer Offset examples,” above.

### Tips for using Offset

#### Converting from bipolar to unipolar

You can use the Offset function to convert a bipolar AMS source (both negative and positive), such as an LFO, to a unipolar signal (positive only). To do so:

1. Select the LFO as the AMS A input.
2. Set the AMS A Amount to 50.

This cuts the overall level of the LFO in half, so that instead of swinging between -99 and +99, it only swings between -50 and +50.

3. Set the AMS A Offset to 50.

This shifts the LFO signal up, so that it now swings between 0 and +99.

#### Converting from unipolar to bipolar

Similarly, you can convert a unipolar AMS source (positive only), such as a knob, joystick, etc., to a bipolar signal (both negative and positive). To do so:

1. Select the AMS source as the AMS A input.

**2. Set the AMS A Amount to +199.**

This doubles the overall level of the AMS source, so that instead of ranging from 0 to +99, it now goes from 0 to +199.

**3. Set the AMS A Offset to -100.**

This shifts the AMS signal down, so that it ranges from -99 to +99.

**Smoothing**

This Mixer Type smooths out the AMS input, creating more gentle transitions between values. You have separate control of the amount of smoothing during the attack (when the signal is increasing) and decay (when it's decreasing).

The higher the Attack and Decay settings, the more that the input will be smoothed.

Low settings provide subtle controller smoothing, creating more gradual aftertouch, for instance. Higher settings create auto-fade effects, transforming a quick gesture into a longer fade-in and/or fade-out event.

Smoothing can also be used to alter the shape of programmable mod sources, such as LFOs and EGs. For instance, you can turn a "blip" into a simple envelope shape, as shown below.

*AMS Mixer Smoothing examples*

Original AMS A:                      Smoothing with Long Attack and Short Release:



Smoothing with Short Attack & Long Release:



**AMS A [List of AMS Sources]**

This selects the AMS source to be smoothed.

For a list of AMS sources, see "Alternate Modulation Source (AMS) List" on page 1091.

**AMS A Attack [00...+99]**

This controls the attack time of the smoother, or how long it takes the smoother to reach a new, *higher* value.

Higher Attack settings mean longer times.

Depending on how quickly the AMS input value is changing, high Attack settings may mean that the value is never quite reached, as shown in "AMS Mixer Shape examples," above.

**AMS A Decay [00...+99]**

This controls the decay time of the smoother, or how long it takes the smoother to reach a new, *lower* value.

Higher Decay settings mean longer times.

**Shape**

This Mixer Type adds curvature to the AMS input. Shape can create custom controller curves, such as exponential joystick, logarithmic velocity, and so on. It can also alter the shape of programmable modulation sources, such as EGs and LFOs.

*Note:* Shape only affects AMS signals which already have some amount of slope, such as EGs, triangle and sine LFOs, and so on. It does not affect signals which only contain abrupt transitions, such as square waves.

**AMS A [List of AMS Sources]**

This selects the AMS input source to be shaped.

For a list of AMS sources, see "Alternate Modulation Source (AMS) List" on page 1091.

**Mode [Symmetric, Asymmetric]**

This selects whether Shape will produce one or two curves. The graphic "AMS Mixer Shape examples" may help to visualize how this works.

**Asymmetric** will produce a single curve, extending from -99 to +99.

**Symmetric** will produce two matching curves extending outwards from 0 to -99 and +99, respectively.

**Shape [-99...+99]**

This controls the amount of curvature, and whether the curves are concave or convex. As you can see in the graphic examples, the shape will tend to emphasize certain value ranges, and de-emphasize others.

Here's a handy chart which shows the results of Shape with the different settings and input types:

Mode	Input	Shape	Result
Symmetric	Unipolar	Positive (+)	emphasizes upper value range
		Negative (-)	emphasizes lower value range
	Bipolar	Positive (+)	emphasizes both upper and lower value ranges, and de-emphasizes the center
		Negative (-)	emphasizes center value range, around 0
Asymmetric	Unipolar	Positive (+)	emphasizes extreme upper range, with offset
		Negative (-)	emphasizes extreme lower range, with offset
	Bipolar	Positive (+)	emphasizes upper value range
		Negative (-)	emphasizes lower value range

For example, let's say that you are using a triangle LFO, through Shape, to modulate filter cutoff. If Shape emphasizes the high value range, the filter will spend more time at the higher frequencies. If it emphasizes the low range, the filter will spend more time at the lower frequencies.

AMS Mixer Shape examples

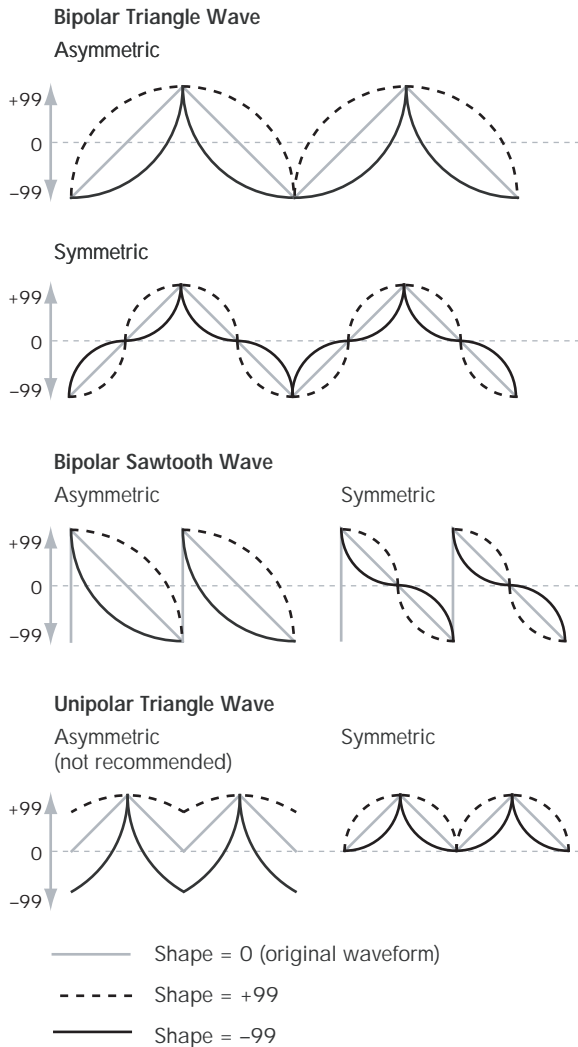

**Bipolar and Unipolar AMS sources**

To understand Shape, it helps to understand the difference between **bipolar** and **unipolar** AMS sources.

**Bipolar** sources can swing all the way from -99 to +99, with 0 in the middle. Most LFOs are bipolar, for instance; so is Pitch Bend.

Generally, bipolar AMS sources will work better with the **Asymmetric** mode, but **Symmetric** may also produce interesting results.

**Unipolar** sources only go from 0 to 99, with 50 in the middle. MIDI controllers, such as JS+Y (CC#1), are all unipolar. In practice, EGs are usually programmed to be unipolar, even though the Filter and Pitch EGs do allow both positive and negative levels.

With unipolar sources, it's almost always better to use the **Symmetric** mode. The **Asymmetric** mode can cause offsets and other strange results.

**Quantize**

This Mixer Type changes the input from a continuous signal into a series of discrete steps. Instead of moving smoothly between values, it will snap immediately from one value to another.

You can use this to change the shape of LFOs or EGs, or to force a controller to land on a few specific values.

AMS Mixer Quantize examples

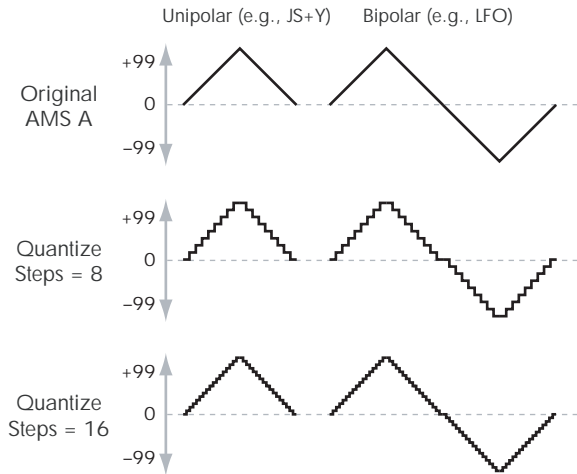

**AMS A**

**[List of AMS Sources]**

This selects the AMS input source to be quantized.

For a list of AMS sources, see "Alternate Modulation Source (AMS) List" on page 1091.

**AMS A # Of Steps**

**[2...32]**

This controls the severity of the effect. The lower the number of steps, the more "steppy" the output will be.

For instance, when this is set to 2, there will be "steps" at 0, 50, and 99. With a bipolar AMS input, there will also be steps at -50 and -99.

As another example, when it is set to 5, there will be steps at 0, 20, 40, 60, 80, and 99 (as well as -20, -40, -60, -80, and -99 for bipolar inputs).

**Tips for using Quantize**

**Quantized Ribbon Pitch Bend**

You can easily use the Ribbon to create quantized pitch bend, for fret-dragging effects, brass rips, and more. To do so:

1. Select the AMS Mixer as the Oscillator Pitch AMS input.
2. Set the Pitch AMS Intensity to any exact half-step value, such as +5.00, +7.00, etc.
3. Set the Ribbon amount to 0.00.
4. In the AMS Mixer, select the Ribbon as AMS A.
5. Set the AMS A # of Steps to the same number you used in Step 2.

Now, playing the Ribbon will create quantized pitch bends. JSX will still produce smooth pitch bends, as usual, so you can use both techniques together.

## Gate

AMS Mixer, Type = Gate

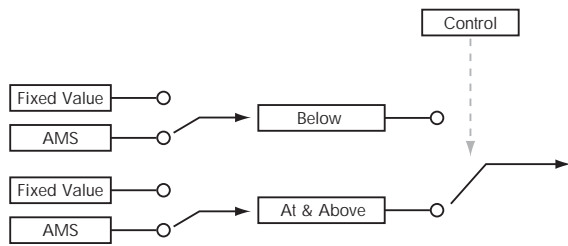

This Mixer Type lets you set up two different AMS sources (or fixed AMS amounts), and then switch between the two using a third AMS source.

It's similar to an audio gate with a side-chain, but with even more flexibility—since you get to choose what happens when the gate is closed (below the threshold), as well as when it's open (above the threshold).

You can also choose whether the gate will be able to open and close continuously in response to the control source, or whether it only opens or closes at the beginning of the note, and then stays that way over the note's entire duration.

You can use the Gate to:

- Use a foot-switch (or other controller) to apply pitch-bend or other effects to some notes, but not to others
- Apply controllers to a parameter only after the controller reaches a certain threshold—for instance, use Velocity to control harmonics in the STR-1, but only once Velocity is greater than 90
- Use a joystick, switch, or other controller to switch between two different LFOs (or any two AMS sources)

### Gate Control

**Source** [List of AMS Sources]

This selects the AMS source to control the gate.

**Control at Note-On Only** [Check-box]

When this is enabled (checked), the value of the **Control Source** at note-on will select the output (**Below Threshold** or **At & Above Threshold**). The selected output will then remain active throughout the duration of the note, regardless of any subsequent change in the **Control Source's** value.

Note that the output value itself can continue to change; only the selection of **Below** or **At & Above** is fixed.

**Threshold** [-99...+99]

This sets the value of the Control Source at which the gate opens or closes.

### Gate Output

If the value of the **Control Source** is less than the **Threshold**, the Gate outputs the preset value or AMS source selected under **Below Threshold**.

If the value of the **Control Source** is greater than or equal to the **Threshold**, the Gate outputs the preset value or AMS source selected under **At & Above Threshold**.

**Below Threshold** [Fixed Value, AMS A]

This selects whether **Below Threshold** uses a preset value, or the selected AMS source.

**Fixed Value** [-99...+99]

This lets you set a specific value to be used when the **Control Source** is less than the **Threshold**. This only applies when **Below Threshold** is set to **Fixed Value**.

**AMS A** [List of AMS Sources]

This lets you set an AMS source to pass through the Gate when the **Control Source** is less than the **Threshold**. This only applies when **Below Threshold** is set to **AMS A**.

**At & Above Threshold** [Fixed Value, AMS B]

This selects whether **At & Above Threshold** uses a preset value, or the selected AMS source.

**Fixed Value** [-99...+99]

This lets you set a specific value to be used when the **Control Source** is greater than or equal to the **Threshold**. This only applies when **At & Above Threshold** is set to **Fixed Value**.

**AMS B** [List of AMS Sources]

This lets you set an AMS source to pass through the Gate when the **Control Source** is greater than or equal to the **Threshold**. This only applies when **At & Above Threshold** is set to **AMS B**.

### Tips for using Gate

#### Selective pitch-bend, using a switch

You can use Control at Note-On Only to apply an effect to some notes, but not others, based on the state of an AMS source at the start of the note. For instance:

1. Set the Control Source to Assignable Foot Switch.
2. Set Control At Note-On Only to On (checked).
3. Set the Threshold to 50.
4. Set Below Threshold to a Fixed Value of 00.
5. Set At & Above Threshold to AMS B: Ribbon (CC#16).
6. On the Pitch Mod page, assign the AMS Mixer to control the pitch.
7. Also on Pitch Mod, set the standard Ribbon amount to 0.

This way, only the AMS Mixer's processed version of the Ribbon will affect the pitch.

8. With the foot-switch off, play a chord, and hold it through step 9.
9. Press down on and hold the footswitch, and then play a new note above the chord.
10. Use the ribbon to bend the pitch of the new note.

The new note will bend, but the original chord (played before you pressed on the foot-switch) will not.



### Selective pitch-bend, using only the joystick

You can also use a single AMS source as both the Control Source and a value source:

1. Set the Control Source to JS X.
2. Set Control At Note-On Only to On (checked).
3. Set the Threshold to 00.
4. Set Below Threshold to AMS A: JS X.
5. Set At & Above Threshold to a Fixed Value of 00.
6. On the Pitch Mod page, assign the AMS Mixer to control the pitch.
7. Also on Pitch Mod, set the standard JS+X and JS-X amounts to 0.

This way, only the AMS Mixer's processed version of the joystick will affect the pitch.

8. With the joystick in the center, play a chord, and hold it through step 9.
9. Bend the joystick to the left, and then play a new note above the chord.
10. Use the joystick to bend the pitch of the new note.

The new note will bend, but the original chord (played before you bent the joystick down) will not. This method is particularly good for bending the top note of a chord up to pitch.

### Generating a static value

Sometimes, it can be handy to have a preset value as an AMS source. The Gate is one way to create this. To do so:

1. Set both Below Threshold and At & Above Threshold to Fixed Value, and enter the same value into each.

Now, the AMS mixer will always generate this static value.

---

### 6-1b: AMS Mixer 2 AMSsource

This is the second AMS Mixer for Oscillator 1. The parameters are exactly the same as those for AMS Mixer 1, as described under "6-1a: AMS Mixer 1" on page 98.

---

### ▼ 6-1: Page Menu Commands

The number before each command shows its ENTER + number-key shortcut. For more information on these shortcuts, see "ENTER + 0-9: shortcuts for menu commands" on page 147.

- 0: **Write Program.** For more information, see "Write Program" on page 147.
- 1: **Exclusive Solo.** For more information, see "Exclusive Solo" on page 147.
- 2: **Copy Oscillator.** For more information, see "Copy Oscillator" on page 153.
- 3: **Swap Oscillators.** For more information, see "Swap Oscillator" on page 153.

---

### 6-5: OSC 2 AMS Mix AMSsource

This page controls the two AMS Mixers for Oscillator 2. These are available only when the **Oscillator Mode** is set to **Double**; if not, the page will be grayed out.

The parameters are identical to those for Oscillator 1, as described under "6-1: OSC 1 AMS Mixer," on page 98.

## 6-9: Common Keyboard Track

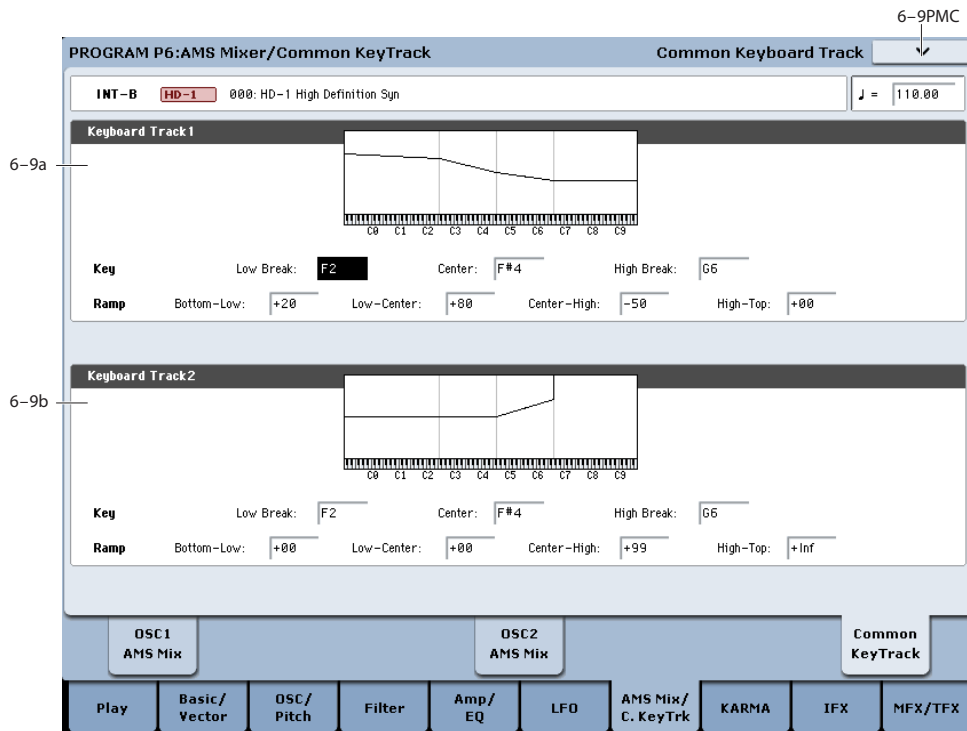

The two Oscillators share two Common keyboard tracking generators, in addition to each Oscillator's dedicated keyboard tracking for the Filter and Amp. You can use these Common keytracks as AMS sources for modulating most AMS destinations.

The Common Key Track parameters are shared by the entire Program, but the actual AMS values are calculated individually for each voice.

### Overview

#### What does Keyboard Tracking do?

At its most basic, keyboard tracking lets you vary the modulation amount as you play up and down the keyboard. This can be useful for making the timbre consistent across the entire range, or adjusting parameters according to pitch.

The KRONOS keyboard tracking can be fairly complex, if desired. You can create different rates of change over up to four different parts of the keyboard. For instance, you can:

- Make the modulation increase very quickly over the middle of the keyboard, and then increase more slowly—or not at all—in the higher octaves.
- Make the modulation increase as you play *lower* on the keyboard.
- Create abrupt changes at certain keys, for split-like effects.

#### Common Keyboard Tracking

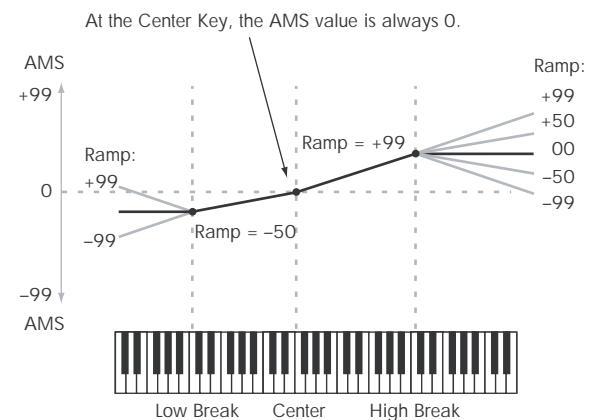

#### How it works: Keys and Ramps

The keyboard tracking works by creating four ramps, or slopes, between five keys on the keyboard. The bottom and top keys are fixed at the bottom and top of the MIDI range, respectively. You can set the other three keys—named Low Break, Center, and High Break—to be anywhere in between.

The four Ramp values control the rate of change between each pair of keys. For instance, if the Low-Center Ramp is set to 0, the value will stay the same between the Low Break key and the Center key.

You can think of the resulting shape as being like two folding doors attached to a hinge in the center. At the Center key (the main hinge), the keyboard tracking has no effect. The two folding doors swing out from this center point to create changes in the higher and lower ranges of the keyboard.



**6-9a: Keyboard Track 1** AMSource

**Key**

**Low Break** [C-1...G9]

This sets the breakpoint note between the two lower ramps - the "hinge" of the lower door.

**Center** [C-1...G9]

This sets the center of the keyboard tracking - the main "hinge." At this key, the keyboard tracking has no effect on the AMS destinations.

**High Break** [C-1...G9]

This sets the breakpoint note between the two higher ramps - the "hinge" of the upper door.

**Entering notes from the keyboard**

You can enter note numbers directly by playing them on the keyboard. To do so:

1. Select one of the Key parameters.
2. Hold down the ENTER key.
3. While holding ENTER, play a note on the keyboard.

**Ramp**

Positive ramp values mean that the keyboard tracking output increases as you play farther from the Center Key; negative ramp values mean that it decreases.

Because of this, the meanings of positive and negative ramp settings will change depending on whether the ramp is to the left or right of the Center Key.

**Bottom-Low and Low-Center:** negative ramps make the keyboard tracking's output go down as you play lower on the keyboard, and positive ramps make the output go higher.

**Center-High and High-Top:** negative ramps make the keyboard tracking's output go down as you play *higher* on the keyboard, and positive ramps make the output go up.

**Bottom-Low** [-Inf, -99...+99, +Inf]

This sets the slope between the bottom of the MIDI note range and the Low Break key. For normal key track, use negative values.

**Low-Center** [-Inf, -99...+99, +Inf]

This sets the slope between the Low Break and Center keys. For normal key track, use negative values.

**Center-High** [-Inf, -99...+99, +Inf]

This sets the slope between the Center and High Break keys. For normal key track, use positive values.

**High-Top** [-Inf, -99...+99, +Inf]

This sets the slope between the High Break key and the top of the MIDI note range. For normal key track, use positive values.

The table below shows how the ramps affect the AMS output:

Ramp value	AMS change
-Inf	goes to -99 in 1 half-step
-99	-20 per octave
-50	-10 per octave
0	no change
+50	+10 per octave
+99	+20 per octave
+Inf	goes to +99 in 1 half-step

**+Inf and -Inf ramps**

+Inf and -Inf are special settings which create abrupt changes for split-like effects. When a ramp is set to +Inf or -Inf, the keyboard tracking will go to its extreme highest or lowest value over the span of a single key.

*+Inf and -Inf Ramps*

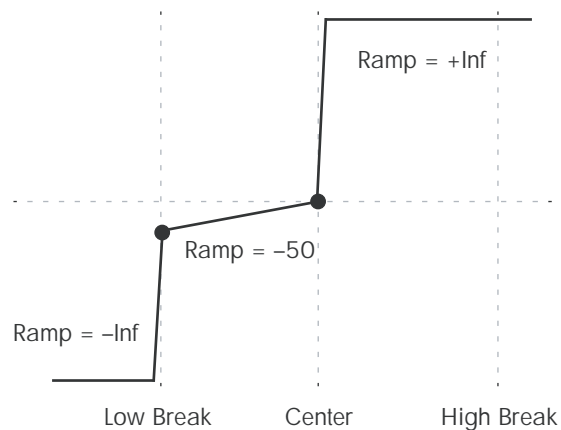

*Note:* if you set the Center-High ramp to +Inf or -Inf, the High-Top parameter will be grayed out. Similarly, if you set the Low-Center ramp to +Inf or -Inf, the Bottom-Low ramp will be grayed out.

**6-9b: Keyboard Track 2** AMSource

This is the second Common keyboard tracking generator.

Its parameters are exactly the same as those for Keyboard Track 1, as described under "6-9a: Keyboard Track 1" on page 106.

**▼ 6-9: Page Menu Commands**

The number before each command shows its ENTER + number-key shortcut. For more information on these shortcuts, see "ENTER + 0-9: shortcuts for menu commands" on page 147.

- 0: **Write Program.** For more information, see "Write Program" on page 147.
- 1: **Exclusive Solo.** For more information, see "Exclusive Solo" on page 147.
- 2: **Copy Oscillator.** For more information, see "Copy Oscillator" on page 153.
- 3: **Swap Oscillators.** For more information, see "Swap Oscillator" on page 153.

## Program P7: KARMA

This pages let you control the Program’s KARMA settings. In Program mode, you can use one KARMA Module (Module A).

### Turning KARMA on and off

KARMA can be enabled or disabled for the current Program by using the front-panel KARMA ON/OFF switch. You can also temporarily disable KARMA for all Programs, Combinations, and Songs by using the Global **All KARMA Off** parameter. For more information, see “All KARMA/DT Off” on page 755.

### Linking KARMA settings to Program changes

KARMA settings can be saved individually for each Program. This includes all of the KARMA-related front-panel buttons, sliders, and knobs, as well as the on-screen parameters.

Normally, when you select a new Program, its KARMA settings will be loaded as well. In some cases, however, you may wish to try out different Programs while keeping the KARMA settings the same.

The Global Basic page **Load KARMA Settings when changing** parameters let you select between these two behaviors. There are separate settings for Programs, Combis, and Songs. To set this up:

1. **Go to the Global Basic page.**
2. **Under “Load KARMA setting when changing”, set the “Programs” check-box as desired.**

Check the box to load the individual Programs’ KARMA settings.

Un-check the box to keep KARMA settings the same, even when changing Programs.

For more information, see the Global parameter “Load KARMA settings when changing” on page 755.

## 7-1: GE Setup/Key Zones

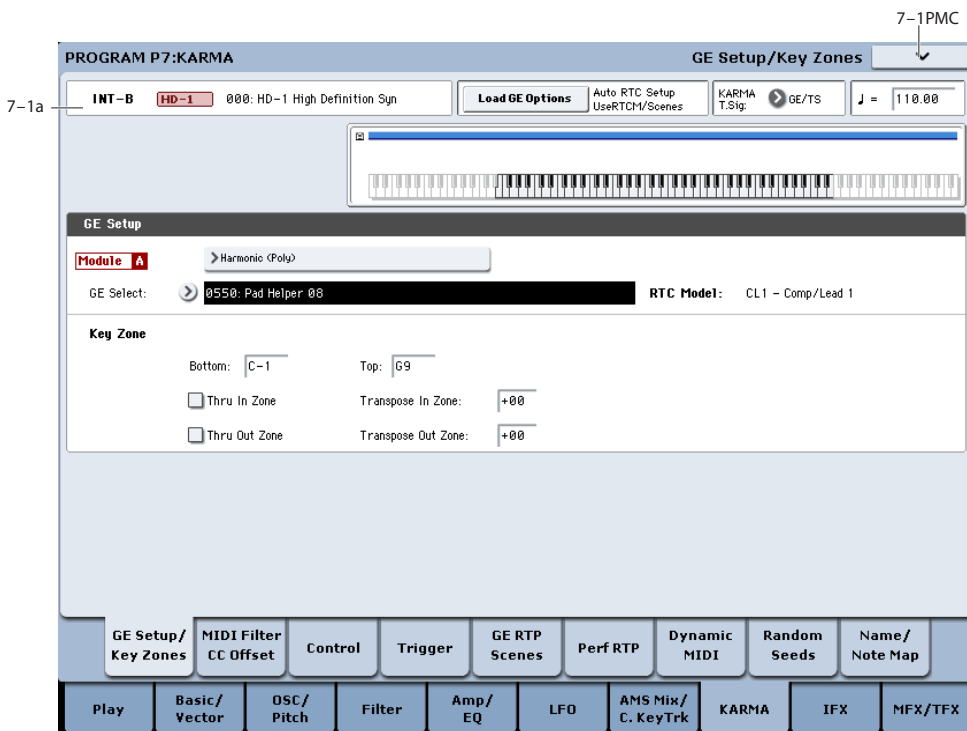

This page lets you select the GE used by the KARMA Module, and set up the Key Zone in which it operates.

### 7-1a: Program Name, Load GE Options, KARMA T.Sig, Tempo

These are the current bank, bank type (HD-1 or EXi), Program, and tempo. For more information, see “1-1a: Program Name and Tempo” on page 36.

**Bank** [INT-A...F, GM, g(1...9), g(d), USER-A...G and AA...GG]

**Bank Type** [HD-1, EXi]

**Program** [0...127 (INT and USER Banks), 1...128 (GM Banks)]

**J (Tempo)** [040.00...300.00, EXT]

**Load GE Options** [Dialogue]

These options let you specify whether the values and assignments for the KARMA SLIDERS and SWITCHES will be set automatically, be initialized, or be preserved when you select a GE.

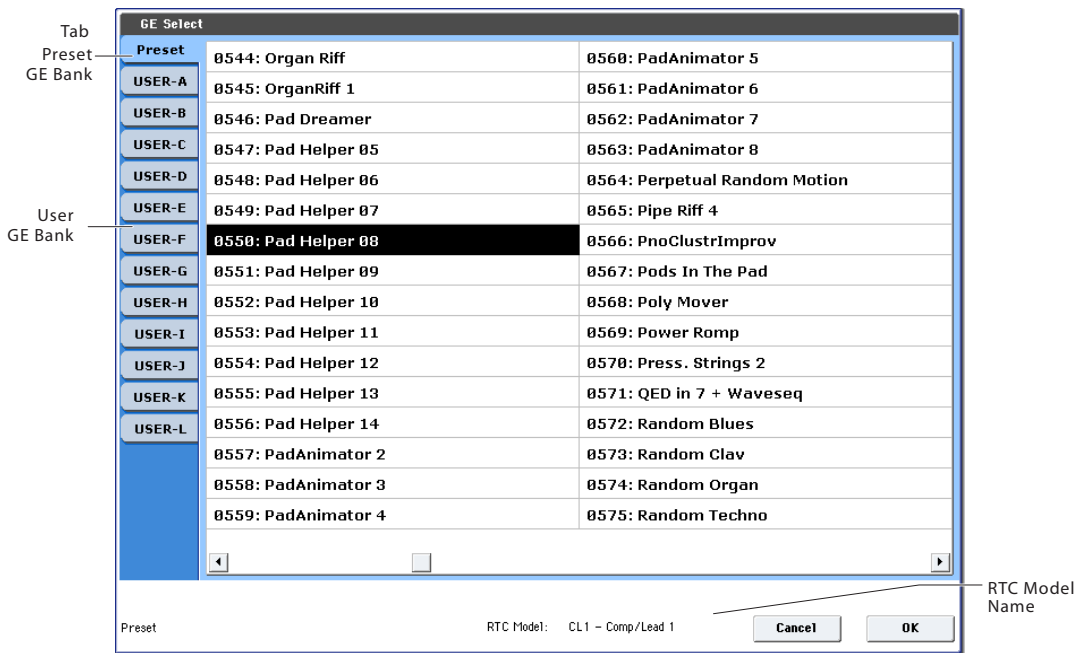

For a detailed description of this parameter, please see “Load GE Options” on page 9.

**KARMA T.Sig (Time Signature)**  
**[GE/TS, 1/4...16/4, 1/8...16/8, 1/16...16/16]**

This specifies the time signature of the phrases or patterns generated by the KARMA Modules. The internal time signature of the phrase or pattern is determined by the GE, but you can set this parameter to change the time signature.

**GE/TS:** The initial time signature specified by each KARMA Module will be used.

**1/4...16/16:** Specify the desired time signature. In Combination and Sequencer modes, this will change the time signature for all four KARMA Modules.

**GE Setup**

**GE Select** **[Preset 0000...2047, USER-A...L 000...127]**

This selects the GE for the KARMA module. There are a total of 3,584 to choose from: 2,048 preset GEs, and 1,536 rewritable User GEs (12 banks of 128 each).

Preset GEs are part of the system software.

User GEs may be included with new banks of sounds, and can also be created using KARMA KRONOS software (dedicated software for the KRONOS\*). For more information on loading User GEs, see “Load .KGE” on page 843.

\* Made by Karma Lab (<http://www.karma-lab.com>). Macintosh and Windows are supported. English version only.

**GE Bank Select** **[Preset...USER-L]**

This selects the GE bank. The Preset bank is part of the system software; User banks can be loaded from disk. For more information, see “GE Select,” above.

**GE Category Select** **[Arpeggio...Real-Time]**

This lets you select a GE by category, from **Arpeggio** through **Real-Time**. For more information, please see “0-6b: GE Select” on page 10.

**RTC Model** **[List of RTC Models]**

This shows the GE’s RTC Model, as specified internally for each preset GE. For more information, see “RTC Model” on page 214 of the Operation Guide.

**Key Zone**

The KARMA Module is controlled by input note data in numerous ways, including the variation of phrase or pattern produced by the GE, by trigger, and by chord detection.

Here you can specify the range of note data (Key Zone) that will control the KARMA Module.

**Note:** within the Key Zone specified Bottom and Top Values will be input into KARMA, while notes outside the Key Zone may be used for other functions, or echoed thru.

**Note:** In Program mode, all MIDI data for the KARMA Module is transmitted and received on the Global **MIDI channel** (Global 2-1).

**Bottom (Key Zone Bottom)** **[C-1...G9]**

Specifies the bottom key (lower limit) of the Key Zone.

**Top (Key Zone Top)** **[C-1...G9]**

Specifies the top key (upper limit) of the Key Zone.

**Note:** These parameters can also be set by holding down the Enter switch and pressing a note.

**Thru In Zone** **[Off, On]**

**On (checked):** Note data from keys within the Key Zone will be input to the KARMA Module, and will also be input directly to the tone generator.

When you play a key within the Key Zone, the phrase or pattern generated by the KARMA Module will sound, as will the note itself.

**Off (unchecked):** Only the phrase or pattern generated by KARMA will sound. Keys played within the Key Zone will not sound.

**Transpose In Zone** [-36...+36]

Specifies the transpose setting applied to note data from within the Key Zone.

Make this setting if you wish to apply a transposition in semitone steps to the pitch of notes played from the keyboard when "Thru In Zone" is **On (checked)**.

**Thru Out Zone** [Off, On]

**On (checked):** Note data from keys outside the Key Zone will be input directly to the tone generator. (They will not be input to the KARMA Module, since they are outside the key zone.) When you play keys outside the key zone, the tone generator will sound.

**Off (unchecked):** The tone generator will not sound even if you play keys outside the Key Zone.

**Transpose Out Zone** [-36...+36]

Specifies the transpose setting applied to note data from keys outside the Key Zone.

Make this setting if you wish to apply a transposition in semitone steps to the pitch of notes played conventionally from the keyboard when "Thru Out Zone" is **On (checked)**.

You could select a bass program and make the settings shown below.

**Example**

Using the KARMA Module to control the bass line in the lower range of the keyboard, and playing in real-time in the upper range.

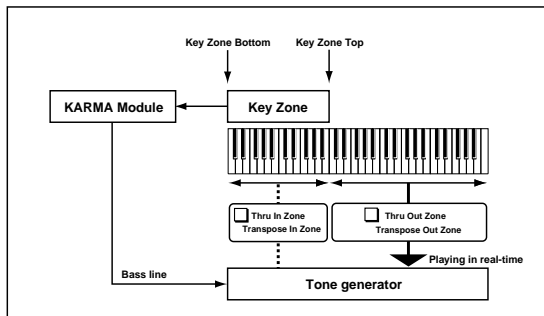

- 0: **Write Program.** For more information, see "Write Program" on page 147.
- 1: **Exclusive Solo.** For more information, see "Exclusive Solo" on page 147.
- 2: **Copy KARMA Module.** For more information, see "Copy KARMA Module" on page 155.
- 3: **Initialize KARMA Module.** For more information, see "Initialize KARMA Module" on page 156.
- 4: **Copy Scene.** For more information, see "Copy Scene" on page 157.
- 5: **Swap Scenes.** For more information, see "Swap Scene" on page 157.
- 6: **Capture Random Seed.** For more information, see "Capture Random Seed" on page 157.

**Module Zone Display**



A solid blue line (green while you're editing the key zone) indicates the specified Key Zone.

Notes and messages from the MIDI IN connector within this zone will be input to the KARMA Module.

▼ **7-1: Page Menu Commands**

The number before each command shows its ENTER + number-key shortcut. For more information on these shortcuts, see "ENTER + 0-9: shortcuts for menu commands" on page 147.

## 7-2: MIDI Filter/CC Offset

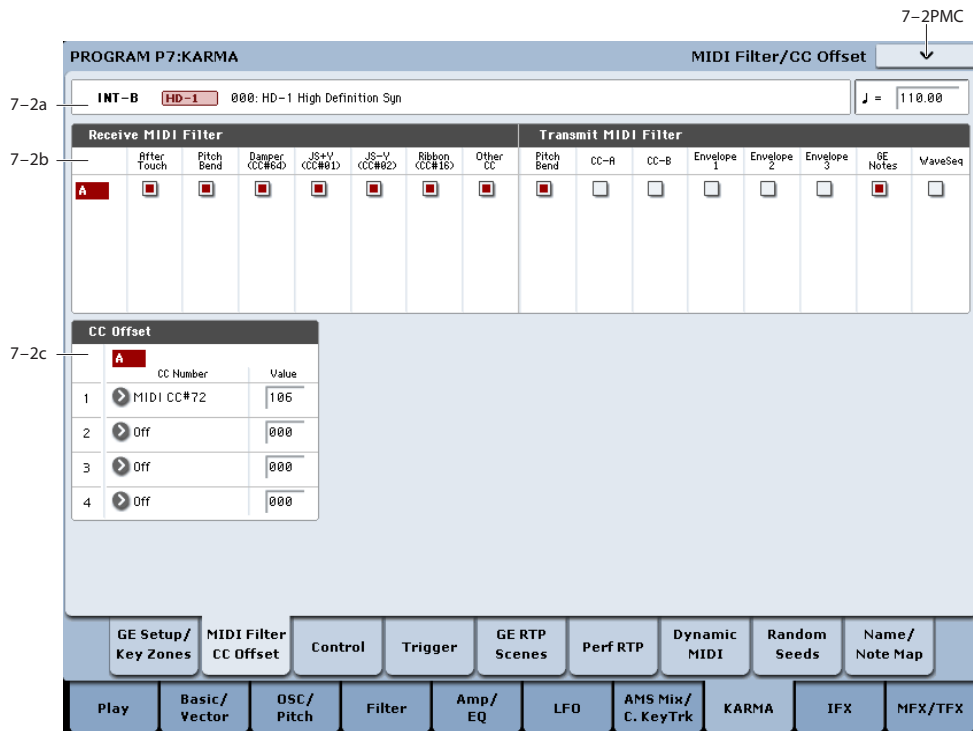

In this page you can make MIDI-related settings for KARMA. You can specify the following settings.

- MIDI filtering for the KARMA module
- MIDI control change messages transmitted when KARMA is turned on (CC Offset parameters)

### 7-2a: Program Name and Tempo

**Bank** [INT-A...F, GM, g(1...9), g(d), USER-A...G and AA...GG]

**Bank Type** [HD-1, EXi]

**Program** [0...127 (INT and USER Banks), 1...128 (GM Banks)]

**♩ (Tempo)** [040.00...300.00, EXT]

These are the current bank, bank type (HD-1 or EXi), Program, and Tempo. For more information, see “1-1a: Program Name and Tempo” on page 36.

### 7-2b: MIDI Filter

#### Receive MIDI Filter

This specifies whether filters will be applied to the MIDI control data received by the KARMA Module before it is passed on (echoed) to the tone generator.

**On (checked):** The corresponding MIDI data will be echoed to the tone generator.

**Off (unchecked):** The corresponding MIDI data will not be echoed to the tone generator.

When KARMA is **on**, the MIDI control data received by the KARMA Module will be transmitted to the tone generator without change. Depending on these

settings, you can (for example) make settings so that the damper pedal is enabled when the KARMA Module is **off**, and disabled when it is **on**. (See the diagram below, “KARMA Receive/Transmit Filter.”)

⚠ These settings do not affect the Dynamic MIDI (7-7) settings. If you have specified MIDI control data as the Dynamic MIDI source, it will be valid regardless of these settings.

**After Touch** [Off, On]

Specifies whether MIDI aftertouch messages will be echoed to the tone generator.

**Pitch Bend** [Off, On]

Specifies whether MIDI pitch bend messages will be echoed to the tone generator.

**Damper (CC#64)** [Off, On]

Specifies whether MIDI control change message #64 Sustain (damper pedal) will be echoed to the tone generator.

**JS+Y (JS+Y CC#01)** [Off, On]

Specifies whether MIDI control change message #1 (internal joystick +Y direction, specified as the assignment of a real-time control knob, or Vector CC control) will be echoed to the tone generator.

**JS-Y (JS-Y CC#02)** [Off, On]

Specifies whether MIDI control change message #2 (internal joystick -Y direction, specified as the assignment of a real-time control knob, or Vector CC control) will be echoed to the tone generator.

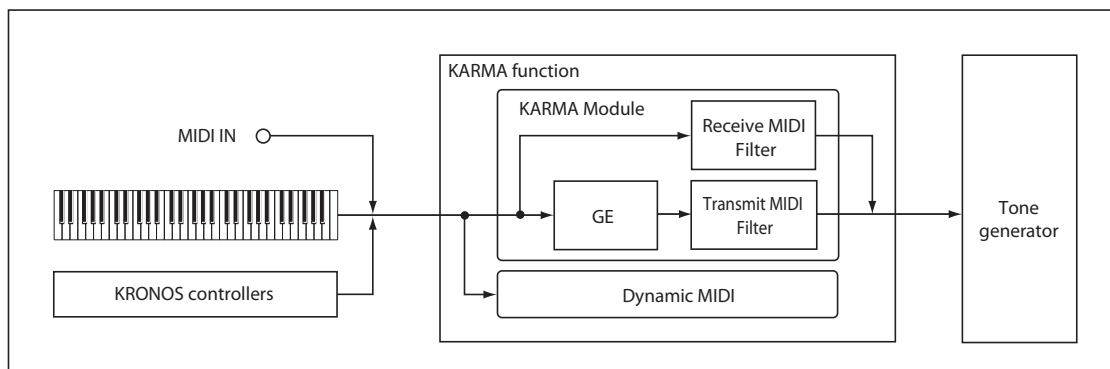

**Ribbon (CC#16) [Off, On]**

Specifies whether MIDI control change message #16 (internal ribbon controller, specified as the assignment of a real-time control knob, or Vector CC Control) will be echoed to the tone generator.

**Other CC [Off, On]**

Specifies whether MIDI control change messages other than the above will be echoed to the tone generator.

**Transmit MIDI Filter**

Specifies whether filtering will be applied to the MIDI control data produced by the GE selected for the KARMA Module. (See the diagram on the preceding page, "KARMA Receive/Transmit Filter.")

**On (checked):** The corresponding MIDI data will be transmitted from the KARMA Module.

**Off (unchecked):** The corresponding MIDI data will not be transmitted from the KARMA Module.

Note: The GE can also automatically produce pitch bend and various types of control change messages in addition to note data. Three envelope generators can also be used to apply time-variant change to velocity, tempo, duration, and various control changes such as pitch bend, JS +Y (CC#1) etc.

The data that is output will depend on the settings of the parameters for the selected GE. For example, transmitting/filtering pitch bend will produce no result if the GE has not been designed to produce pitch bend data. For more information, please see the separate Voice Name List (VNL).

**Pitch Bend [Off, On]**

Specifies whether to transmit the MIDI pitch bend messages generated by the GE selected for the KARMA Module.

Note: This setting also applies to the pitch bend messages that may be produced by CC-A, CC-B, Envelope 1, Envelope 2, and Envelope 3.

⚠ When KARMA is on and the KARMA Module is producing pitch bend data, the pitch bend range of the program will be controlled as follows.

The pitch bend range specified within KARMA GE will automatically be transmitted from the KARMA Module, and set within the program. This ensures that the pitch bend data produced by the GE of the KARMA will function correctly. At this time, the

pitch bend data produced when you operate the joystick will automatically be optimized so that it will produce the same bend effect as if the KARMA were off (in most cases).

**CC-A/CC-B [Off, On]**

Specifies whether to transmit the various MIDI messages generated by CC-A/CC-B of the GE selected by the KARMA Module.

⚠ However if CC-A/CC-B are producing pitch bend messages, these settings will be ignored, and the "GE Bend" setting will be used.

**Envelope1/Envelope2/Envelope3 [Off, On]**

Specifies whether to transmit the various MIDI messages or other functions generated by Envelope 1, Envelope 2, and Envelope 3 of the GE selected by the KARMA Module.

⚠ If Envelope 1, Envelope 2, or Envelope 3 are producing pitch bend messages, these settings will be ignored, and the "GE Bend" setting will be used.

**GE Notes [Off, On]**

Specifies whether the MIDI note-on/note-off messages generated by the KARMA Module will be transmitted.

Note: This setting lets you mute the note phrases generated by the KARMA Module, and use only the control data generated from the KARMA Module (e.g., pan, filter cutoff, resonance) to apply modulation to phrases or chords you yourself play on the keyboard.

**WaveSeq [Off, On]**

Specifies whether the wave sequence data (multisample number) generated by the KARMA Module will be transmitted.

**7-2c: CC Offset**

When KARMA is **turned on**, MIDI control change messages can be transmitted to the tone generator. Make these settings when you wish to control the program sound or effects etc. when KARMA is **turned on**.

You can assign up to four MIDI control changes for each KARMA Module.



1, 2, 3, 4

**CC Number** [Off, MIDI CC# 00...MIDI CC# 95]

Selects the MIDI control change message that will be transmitted.

The value of the transmitted message is specified by "Value".

 If the KARMA ON/OFF switch is **on**, the specified MIDI control change message will be transmitted when you select a program whose KARMA ON/OFF switch is turned **on**. If the selected GE produces the control change specified here, the effect of the control change produced by the GE will be given priority.

Note: The MIDI control change messages specified here for transmission and the MIDI control change messages produced by the selected GE when the KARMA ON/OFF switch is **On** will be reset automatically when the KARMA ON/OFF switch is turned **off**.

**Value** [000...127]

Specifies the value of the message that will be transmitted.

This will have no effect if "CC Number" is **Off**.

▼ **7-2: Page Menu Commands**

The number before each command shows its ENTER + number-key shortcut. For more information on these shortcuts, see "ENTER + 0-9: shortcuts for menu commands" on page 147.

- **0: Write Program.** For more information, see "Write Program" on page 147.
- **1: Exclusive Solo.** For more information, see "Exclusive Solo" on page 147.
- **2: Copy KARMA Module.** For more information, see "Copy KARMA Module" on page 155.
- **3: Initialize KARMA Module.** For more information, see "Initialize KARMA Module" on page 156.
- **4: Copy Scene.** For more information, see "Copy Scene" on page 157.
- **5: Swap Scenes.** For more information, see "Swap Scene" on page 157.
- **6: Capture Random Seed.** For more information, see "Capture Random Seed" on page 157.

**7-3: Module Parameters-Control**

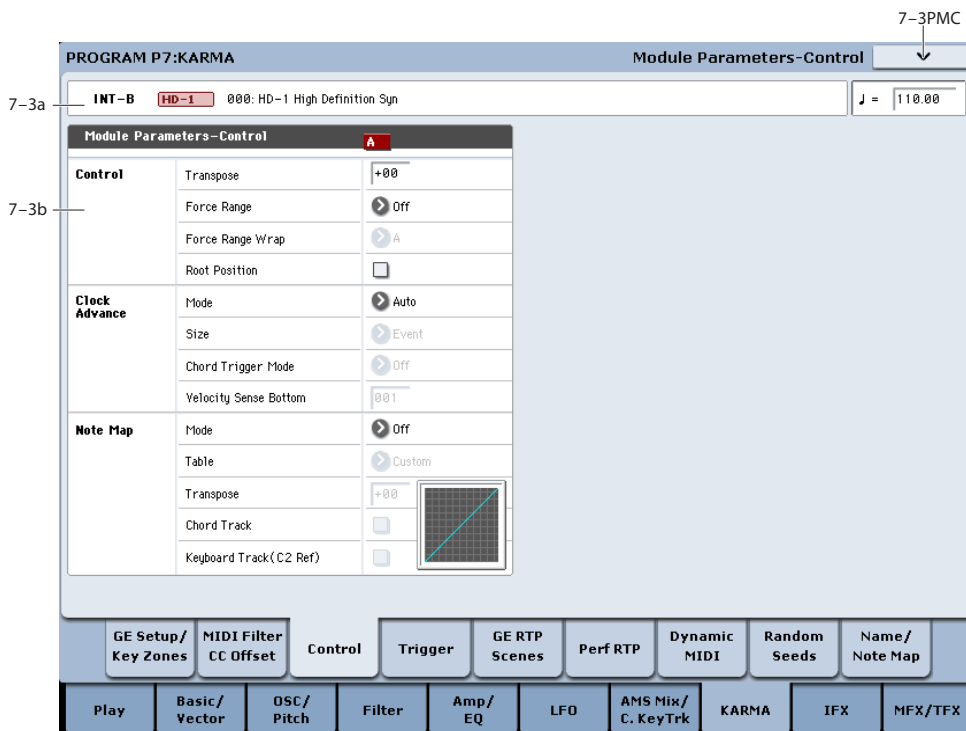

Here you can set KARMA Module Control parameters. Note that in Program mode, you can use one KARMA Module (Module A).

You can make the following settings:

- Specify the transposition, range, and chord inversion for phrases and chords generated by the KARMA module
- Control the clock that operates the KARMA module

- Convert or delete the note data generated by the KARMA module.

**7-3a: Program Name and Tempo**

For descriptions of these parameters, please see "7-2a: Program Name and Tempo" on page 110.



## 7-3b: Module Parameter-Control

### Control

#### Transpose [-36...+36]

Controls the pitch of the phrases or chords produced by the KARMA Module, in semitone steps.

The note data from the keyboard or the MIDI IN connector will be input to the KARMA Module. (See Program 7-1a: "Bottom (Key Zone Bottom," "Top (Key Zone Top)") Here you can transpose the pitch (in semitone steps) of the note data that is input to the KARMA Module.

#### Force Range [Off, Lowest, Highest, C3-B3[1], C3-B3[2]]

Controls the pitch range of the phrases or chords produced by the KARMA Module, in relationship to the area of the keyboard that is played.

Note data from the keyboard or the MIDI IN connector will be input to the KARMA Module ("Bottom (Key Zone Bottom," "Top (Key Zone Top)" (7-1b), "Transpose" 7-3a). Here you can make settings so that the note data input to the KARMA Module is restricted to a specific range.

**Off:** The input notes will be sent to the KARMA Module as played, with no further alteration.

**Lowest:** The input notes will be forced to a range within one octave of the lowest note, and duplicate pitches are discarded. Useful for eliminating inversions so that a chord voiced in different ways produces identical results.

If you play a chord of **E2, E4, G#4, B4, and D#5** (i.e., **E Maj7**) on the keyboard, the input notes will all be transposed to be within an octave of the lowest note (**E2**): **E2, G#2, B2, and D#3**.

**Highest:** The input notes will be forced to a range within one octave of the highest note, and duplicate pitches are discarded. Useful for eliminating inversions so that a chord voiced in different ways produces identical results.

If you play a chord of **E2, E4, G#4, B4, and D#5** (i.e., **E Maj7**) on the keyboard, the input notes will all be transposed to be within an octave of the highest note (**D#5**): **E4, G#4, B4, and D#5**.

Played on keyboard:

**E2 E4 G#4 B4 D#5** (play an EMaj7 chord)

Resulting transposed input notes:

**Lowest:** input notes transposed to **E2 G#2 B2 D#3**

**Highest:** input notes transposed to **E4 G#4 B4 D#5**

**C3-B3[1]:** all notes near 4th octave (maintain inversion)

The input notes will be forced to a range near the middle octave (C3-B3). The "Force Range Wrap" parameter will become available (see below), and specifies the scale step at which a wrap around will be performed. For example, if "Force Range Wrap" = 7: G, if the pitch of the lowest note is C to F#, it will be placed in the 4th octave with the other notes grouped above it. If the pitch of the lowest note is a G to B, it will be placed in the 3rd octave, with the other notes grouped above it. Playing the same chord

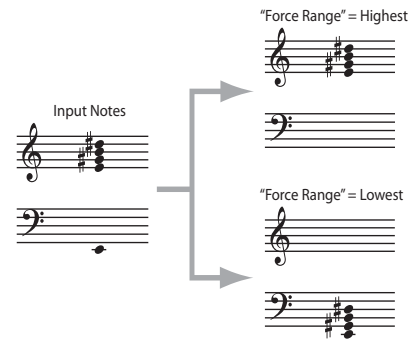

chromatically up the keyboard will "wrap around" when the scale step of the root of the chord is determined to be "G," dropping the notes down an octave. This essentially maintains the inversion the chord was played with - notes may also extend into the 5th octave or 3rd octave.

This is effective when you wish to produce phrases or patterns having a similar inversion to what was played, but in a fixed range regardless of where you are playing on the keyboard. The behavior is similar to an auto-accompaniment pattern, in that no matter where you play on the keyboard, the result is in the same octave.

**C3-B3[2]:** The input notes will be forced to a range within the center octave (C3-B3). because of this, the chord inversion will change significantly; for example, the bass note may change. This is effective when you want to absolutely limit the input notes to a specific octave.

Played on keyboard:

Play chords in the order of

**E4 G#4 B4 D#5** (EMaj7 first inversion)

**G#4 B4 D#5 E5** (EMaj7 second inversion)

**B4 D#5 E5 G#5** (EMaj7 third inversion)

**D#5 E5 G#5 B5** (EMaj7 fourth inversion)

**C3-B3[1]**

Resulting transposed input notes:

**E3 G#3 B3 D#4** (EMaj7 first inversion)

**G#2 B2 D#3 E3** (EMaj7 second inversion)

**B2 D#3 E3 G#3** (EMaj7 third inversion)

**D#3 E3 G#3 B3** (EMaj7 fourth inversion)

**C3-B3[2]**

Resulting transposed input notes:

**D#3 E3 G#3 B3** (EMaj7/D#)

**D#3 E3 G#3 B3** (EMaj7/D#)

**D#3 E3 G#3 B3** (EMaj7/D#)

**D#3 E3 G#3 B3** (EMaj7/D#)

(all identical)

#### Force Range Wrap [C...B]

When "Force Range" (above) is set to **C3B3[1]**, this parameter sets the highest scale step for the chord's root note, after which the range-modified input notes will be dropped down an octave in order to stay

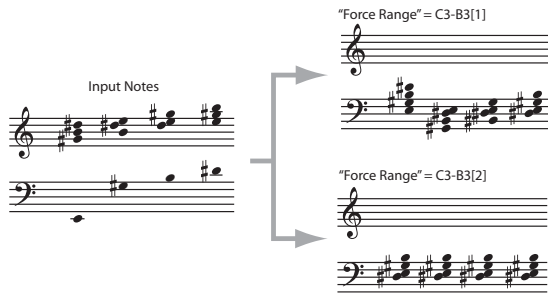

centered around the 4th octave. For example, if the value is F#, then starting with G the notes will be dropped down an octave.

FIG. 4 shows an example where a Maj7 chord in a variety of voicings is played through 7 scale tones, i.e. CMaj7, DMaj7, EMaj7, FMaj7, GMaj7 etc. Since "Force Range Wrap" = F#, the resulting input notes drop down an octave starting with the GMaj7 chord. This allows you to keep a GE in a specific range regardless of where a chord is played on the keyboard, but to adjust at which point it drops down an octave.



Note: Not available unless "Force Range" is set to C3B3[1].

**Root Position [Off, On]**

The phrases and patterns produced by a KARMA Module are generated by a GE (Generated Effect). In most cases, this is done based on a Note Series. When "Root Position" is On (checked), the Note Series will be created in root position, regardless of the inversion of the chord, based on chord recognition. In other words, when this is **Off (unchecked)**, if you play CMaj/E, the Note Series will start from E and continue up, or if you play CMaj/G, the Note Series will start with G. By using "Root Position" **On (checked)**, you can make sure that any inversion of a chord ends up the same. For example, CMaj/E and CMaj/G will both be the same as CMaj, and the Note Series will start from a C. This can allow a GE to behave more predictably with all inversions of a chord. (See "Note Series Group" on page 1026.)

Note: When the GE-Type is **Generated-Drum**, the notes come from Drum Patterns and not the Note Series. The drum patterns can be used to generate melodies, in addition to drum and percussion grooves. "Root Position" also has a similar effect on how the Drum Patterns are transposed, but only if "Drum-Track Keyboard" is **on**. For more information, see "Drum Group" on page 1073.

Also when the GE-Type is **Generated-Drum**, if using arpeggiated pitch-bending (based on the Note Series), the resulting pitch bend data will be affected as well. For more information, see "Bend Group" on page 1069.

When the "GE-Type" is **Real-time**, this parameter has no effect unless you are using Dynamic MIDI to Direct Index the Note Series (see "Dynamic MIDI Sources & Destinations" on page 1109).

**Note:** when "Root Position" is turned on for any "Note Type" except Regular (i.e. Scalic, Scalic2, Chromatic, Whole Tone etc.), the behavior is very consistent: the scale specified by the Note Type is placed in root position before applying the rest of the Note Series parameters to create the Note Series.

However, when "Root Position" is turned on for "Note Type" Regular, the behavior is a bit different, and requires some explanation, as below.

If the input notes span an octave or less, the effect is very predictable, and similar to the effect when "Note Type" is any other setting besides Regular.

If the input notes span an octave or less:

Input Sort is:	Result on Input Notes before replication:
Up	Notes placed in root position for chord, in octave of lowest note, sorted in up direction
Down	Notes placed in root position for chord, in octave of lowest note, sorted in down direction
As Played Random	Notes are arranged so the first note is the root pitch class.

If the input notes span more than an octave, the effect is less predictable. If the "Input Sort" = Up, As Played, or Random, the first note of each replication will be the root pitch class (meaning that the Note Series will start with the root note, i.e. if the key of the chord is D, the first note will be a D). If the "Input Sort" = Down, then the last note of each replication will be the root pitch class. However, notes lower than the root note will still be allowed, since, after all, the purpose of "Note Type" = Regular is to collect the notes as played. For example, with "Input Sort" = Up, if you play G2 – C4 – E4 – G4 (Cmaj/G), the notes will be ordered so that a C is first, but the low G will still be present in each replication.

If the input notes span more than an octave:

Input Sort is:	Result on Input Notes before replication:
Up, As Played Random	Notes are arranged so the first note is the root pitch class (i.e. if the key of the chord is D, the first note will be a D). Notes lower than the root note will still be allowed.
Down	Notes are arranged so the last note is the root pitch class. Notes lower than the root note will still be allowed.

Note that "Force Range" may be applied in conjunction with "Root Position." For example, with any Force Range setting other than "Off," the effects of "Root Position" with "Note Type" = Regular become quite predictable, as spans greater than an octave are essentially compressed into one octave before going into the Note Series section.

**Clock Advance**

Here you can make settings for the clock that will operate the KARMA Module. By using these settings in conjunction with the Dynamic MIDI (Program 7-7) function, you can use **Manual Advance** by operating controllers such as the joystick or notes from the keyboard to trigger the clock that operates the KARMA Module, causing the phrase or pattern to advance under your control.

**Mode [Auto, Dyn, Auto+Dyn1, Auto+Dyn2]**

**Auto:** The KARMA Module will operate according to the **Tempo** (Program 1-1a) setting. If **MIDI Clock** (Global 2-1a) is External, the KARMA Module will operate in synchronization with the MIDI clock from the **External** MIDI device. Normally you will select **Auto**.

**Dyn:** The clock by which the KARMA Module will operate can be triggered by operating the joystick or other controller according to the Dynamic MIDI (Program 7-7) setting, causing the phrase or pattern to advance, note by note. (Set Dynamic MIDI **Destination** to **Clock Advance**.)

You can input a chord from one area of the keyboard, and use notes from another area of the keyboard to advance through the arpeggio pattern.

**Auto+Dyn1:** The KARMA Module will operate according to both **Auto** and **Dyn**.

**Auto + Dyn2:** The KARMA Module will operate according to both **Auto** and **Dyn**, except that a trigger received from Dynamic MIDI will momentarily stop the automatic advancement until the KARMA Module playback is restarted.

**Size [Musical Notation] Event]**

This is valid when **Mode** is **Dyn, Auto + Dyn1** or **Auto + Dyn2**. It specifies the unit by which the phrase or pattern will be advanced when the controller is operated.

**3...:** The phrase or pattern will be advanced by the specified note value, synchronized to the rhythm of the phrase or pattern. Depending on the internal GE Rhythm Parameters, this may result in no notes, 1 note, or several notes for a particular trigger.

**Event:** The phrase or pattern will be advanced by one note or one chord, ignoring the rhythm of the phrase or pattern. Each trigger will produce the next note or chord in the phrase.

**Chord Trigger Mode [Off, 1st, Chord1, Chord2, Chord3]**

This is valid when "Mode" is **Dyn, Auto + Dyn1** or **Auto + Dyn2**. It specifies how a chord will be sounded when that chord is input from the keyboard.

**Off:** There will be no sound when you input a chord from the keyboard. This is analogous to a guitarist changing chords in the left hand. The phrase or pattern will sound from the first step when you operate the controller.

**1st:** When you input a chord from the keyboard, the first step of the phrase or pattern will sound. When you operate the controller, the phrase or pattern will continue advancing.

**Chord1:** When you input a chord from the keyboard, the first several steps of the phrase or pattern will sound, according to the number of notes that you input. When you operate the controller, the phrase or pattern will continue advancing.

**Chord2:** When you input a chord from the keyboard, it will sound in the same way as for Chord1. However, the phrase or pattern will play from the beginning of the pattern when you operate the controller.

**Chord3:** When you input a chord from the keyboard, it will sound in the same way as for Chord1. However, the phrase or pattern will start from the second step when you operate the controller. When simulating acoustic guitar finger picking, this allows you to create a natural connection between the played chord and the finger picking sounded by the controller.

**Velocity Sense Bottom [001...127]**

This is valid when **Mode** is **Dyn, Auto + Dyn1** or **Auto + Dyn2**. If the Dynamic MIDI **Source** is **Note** or **Velocity**, the phrase will be produced by applying the velocity of each Manual Advance trigger that is input to the KARMA Module to the notes as they are generated. This parameter specifies the lower limit of a scaled range that the velocity is adjusted by before being applied.

With a setting of **001**, the velocity data will be input to the KARMA Module with an unmodified range of 1-127 (full sensitivity).

With a setting of **064**, velocity data in the range of 1-127 will be scaled to the range of 64-127 before it is input to the KARMA Module (half sensitivity).

**Note Map**

The Note Map Parameters allow a "final note shaper" to be applied at the end of the KARMA note generation process. Implemented as a large grid (128 x 129), it allows any incoming MIDI note generated by KARMA (0-127) to be remapped to any other MIDI note (0-127), or filtered out (removed). Therefore, a diagonal line represents "linear/no change," and what goes in is what comes out.

You can use it to remap drum kits from one set of drum sounds to another, remove or substitute different drum sounds within the same kit, remove certain pitches from melodic output, constrain output pitches to various scales, limit notes generated thru Melodic Repeat to certain pitches, and more. For more information, see "Repeat (Melodic Repeat) Group" on page 1063.

Each program, combination, or song contains a single user table, named "Custom." The settings of this single table are stored inside the program, combination, or song. Additionally, there are a number of tables stored in global memory, with pre-defined functions, that can be selected for use by any Module.

The same table can be applied to multiple Modules at the same time. All Modules can run through the single Custom table at the same time, or be assigned to utilize various Global Note Maps, in any combination.

**Mode (Note Map Mode) [Off, On-Main, On-Repeat, On-All]**

Selects one of several different modes of operation, controlling whether all notes generated by KARMA or a subset of those notes are modified by the specified Note Map Table.

**Off:** The table is inactive and no filtering or remapping is done.

**On-Main:** The table is used to map or filter notes being generated from the Note Series or Drum Pattern(s), but not any notes generated as a result of the Melodic Repeat parameters.

**On-Repeat:** The table is used to map or filter notes being generated as a result of the Melodic Repeat parameters, but not the main notes generated by the Note Series or Drum Pattern(s). For example, this can be used to “thin out” repeats or limit “strange notes” in Drum Patterns from transposed repeats, without affecting the main notes.

For more information, see “Repeat (Melodic Repeat Group)” on page 1063.

**On-All:** The table is used to map or filter all notes being generated by the module.

**Table (Note Map Table) [Custom, Gtable 1...Maj 7 -> oct]**

Selects the Custom table (user table) or one of the Global Note Map Tables.

**Note:** You can edit custom tables in Program 7-9: Name/Note Map. (See “7-9c: Note Map” on page 132.)

**Transpose (Note Map Transpose) [-12...+12]**

This allows you to set up a “Fixed” Note Transpose Map, without “Chord Track” or “Keyboard Track (C2 Ref),” and then apply an offset to transpose it to other keys. In other words, you can set up a fixed map so that no matter what you play, it comes out in C Mixolydian. Then, you can set the Note Map Transpose to +2, and it would be D Mixolydian, etc.

 The “Transpose” parameter is only available when “Chord Track” is Off (unchecked).

**Chord Track (Note Map Chord Track) [Off, On]**

Selects whether the Note Map Table will track your chord changes within the range of a single octave.

Tables use the key of C as a reference. As an example, assume you play a C Chord that generates a C Major arpeggio (C-E-G etc.) in the Middle C octave (C4 to C5). You edit that octave in the note Map Editor to have no 3rd (E4 removed).

With “Chord Track” set to Off (unchecked), playing a D chord would exhibit no changed notes, because there is no E4 in the arpeggio. With “Chord Track” set to On (checked), the D chord would sound the same as the C chord (no 3rd), except it would be in the key of D. When On (checked), all chords played in the Middle C octave would have their 3rd removed.

However, if you play the input chord an octave lower, the notes would go through the octave of the table below Middle C, and would not have the removed note. This allows you to set up different maps for each octave, yet have the table track your chord changes within each octave.

**Note:** The way that this parameter works is affected by **Kbd Track (C2 Ref)**, below.

**Keyboard Track (C2 Ref) (Note Map Kbd Track) [Off, On]**

Selects whether the Note Map Table will track your chord changes across the entire keyboard, with reference to C2.

When Chord Track is already turned on, setting “Kbd Track” to On (checked) provides the additional functionality of tracking the table to the lowest note of the input chord (with reference to C2), no matter where it is played. In other words, any chord played in any octave will be transposed so it ends up with its lowest note in the C2 octave before being run through the table, and returned to the correct octave after. As an example, assume you play an input chord in the key of C in the C2 octave (lowest octave of a 61 note keyboard). If you remove the 3rd (for example) which is E2, playing a chord anywhere on the keyboard will have the lowest note run through the table at C2 and hence keep the exact same table mapping for any chord, removing the third in any key, in any octave. This allows you to set up complex melodic maps spanning several octaves if desired, and then have them track your chords all over the keyboard.

**Note:** Not available unless “Chord Track” is set to On (checked).

**Note Map Table Display**

This displays a small graphic of the current Note Map Table selected for the Module. Changing the “Note Map Table” setting (directly or via Real-Time Parameter Control) causes the selected table to be displayed.

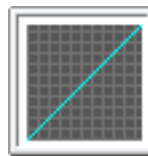

The various Note Map Tables can be viewed full size on the Note Map Page (7-9c).

When you press the display, you will move to the note map table for the same module in the Note Map tab of the Name/Note Map page.

**▼ 7-3: Page Menu Commands**

The number before each command shows its ENTER + number-key shortcut. For more information on these shortcuts, see “ENTER + 0-9: shortcuts for menu commands” on page 147.

- **0: Write Program.** For more information, see “Write Program” on page 147.
- **1: Exclusive Solo.** For more information, see “Exclusive Solo” on page 147.
- **2: Copy KARMA Module.** For more information, see “Copy KARMA Module” on page 155.
- **3: Initialize KARMA Module.** For more information, see “Initialize KARMA Module” on page 156.
- **4: Copy Scene.** For more information, see “Copy Scene” on page 157.
- **5: Swap Scenes.** For more information, see “Swap Scene” on page 157.
- **6: Capture Random Seed.** For more information, see “Capture Random Seed” on page 157.



## 7-4: Module Parameters-Trigger

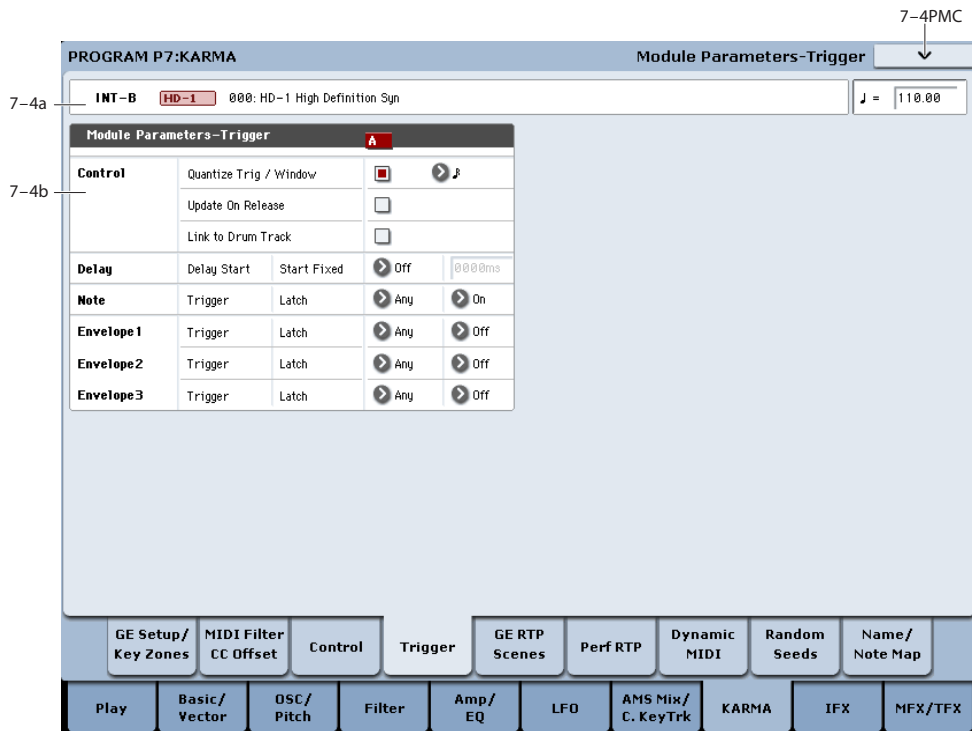

Here you can set KARMA Module Trigger parameters. In Program mode, you can use one KARMA Module (Module A).

You can make the following settings.

- Timing correction and latch operation for triggers
- Settings for the envelope generators inside the GE

### 7-4a: Program Name and Tempo

For descriptions of these parameters, please see “7-2a: Program Name and Tempo” on page 110.

### 7-4b: Module Parameters-Trigger

#### Control

#### Quantize Trig/Window

#### Quantize Trigger [Off, On]

Quantize (correct) the timing of the Module’s triggering caused by input note data from the keyboard or Dynamic MIDI.

On (checked): Trigger timing will be quantized to the metric unit specified by the “Window” setting, relative to the basic tempo.

Off (unchecked): Triggering will occur instantly at the moment you play the keyboard or activate a trigger through Dynamic MIDI.

#### Quantize Window [♪♩...♪]

Specify the metric division by which input note data from the keyboard or Dynamic MIDI will be quantized before triggering the Module and the start of the phrase.

16th triplet...Quarter: Specify the time window as a note value interval relative to the tempo. For triplet-based patterns, you may need to select one of the triplet-based settings if you intend to retrigger “off the beat.”

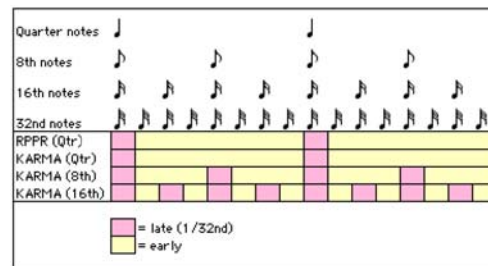

Note: When Quantize Trigger is On (checked), triggering at a timing that is within a 32nd note of the Quantize Window setting will be considered “late” (shown by the pink color in the diagram above), and will cause the playback to begin immediately while bringing the Module into sync with other running Modules or time-based features such as the Drum Track and RPPR. If the trigger is later than this (shown by the yellow color in the diagram above), playback will start at the next metric division corresponding to the Quantize Window.

#### Update On Release [Off, On]

Allows the release of individual input notes to remove those notes from the notes going to the GE, thereby changing the effect to use only those notes still being held.

**Off (unchecked):** Releasing some notes while holding others causes no change to the input source material, and therefore no change in the Generated Effect. This is the most smooth and natural way, and similar to most advanced auto-accompaniment keyboards.

**On (checked):** Notes that are released are removed from the input source material, thereby changing the effect to use only those notes still being held. This is typically the way simple arpeggiators work, especially if their latch mode is turned off.

**Link to Drum Track** [Off, On]

If **Link to Drum Track** is on (selected), KARMA will start and stop along with the Drum Track. The front panel LINKED LED will light to show that the link is enabled.

KARMA will still only play if the KARMA On/Off switch is on. So, once **Link to Drum Track** is on:

**1. Turn on the KARMA ON/OFF switch.**

Even if notes are played on the keyboard or received via MIDI, KARMA won't start to play yet unless the Drum Track is also on.

**2. Turn on the DRUM TRACK switch.**

At this point, both the Drum Track and KARMA will start according to the Drum Track's Trigger Mode settings.

If **Trigger Mode** is set to Start Immediately, KARMA will start to play when you turn on the DRUM TRACK switch (if you're playing the keyboard, or if the KARMA LATCH switch is on).

If **Trigger Mode** is set to Wait KBD Trig, KARMA will start when you play the keyboard (or when a note-on is received).

For more information, see "1-3: Drum Track" on page 42.

If you turn the DRUM TRACK switch off while KARMA is playing, KARMA will also stop.

**Delay**

**Delay Start** [Off, Fixed,  $\text{♩} \dots 4x1$ ]

Specify the delay from when the trigger (by note data) is input, until the phrase or pattern starts.

$\text{♩} \dots 4x1$ : Specify the delay time as a note value interval relative to the tempo.

**Fixed:** The delay time will be specified in time units (ms). Set the time in "Delay Start Fixed."

**Delay Start Fixed** [0000 ms... 5000 ms]

This is valid if "Delay Start" is set to **Fixed**. Set "Delay Start" in ms units. The delay specified here will remain constant, even when the tempo is changed.

**Note**

**Note Trigger** [Any, AKR, 1st, Dyn]

**Any (Any Note + Dynamic MIDI):** Every note-on will cause triggering; i.e., each note-on will cause the phrase or pattern to restart from the beginning.

**AKR (1st Note After Key Release + Dynamic MIDI):** Triggering will occur when the first note-on occurs from a state in which no keys are "on." Triggering will

not occur if even one note is being pressed. By changing the chord you play on the keyboard while holding at least one note, you can change the notes of the phrase or pattern without triggering.

**1st (1st Only Until Module Stops + Dynamic MIDI):**

After KARMA function is turned on, only the first note-on will cause triggering. Subsequent note-ons will not cause triggering.

This is useful for drum grooves and phrases where you do not want subsequent chord changes to restart the phrase.

**Dyn (Dynamic MIDI):** Triggering will be produced by operating the controller specified by Dynamic MIDI (Program 7-7). In this case, note-ons will not cause triggering.

Note: With any of these settings, the trigger will be applied by operations of the controller specified for Dynamic MIDI (Program 7-7), if "Destination" is set to **Trigger Notes&Envs, Trigger Note** (see "Dynamic MIDI Sources & Destinations" on page 1109).

**Note Latch** [Off, On]

Specifies whether the phrase or pattern will continue when you release your hand from the keyboard (**latch on**) or whether the phrase or pattern will stop (**latch off**). In Program mode, turn this **On (checked)** and use the LATCH switch to control latch on/off.

**Off (unchecked):** Latch will be off regardless of the LATCH switch on/off status.

**On (checked):** The LATCH switch will control latch on/off.

When the LATCH switch is **off** (LED dark), **latch is off**.

When the LATCH switch is **on** (LED lit), **latch is on**.

Note: In Combination and Sequencer mode, up to four KARMA Modules can be used. In these modes, you can turn "Note Latch" on/off independently for each KARMA Module. If you use "Copy KARMA Module" to copy KARMA Module settings from these modes to a program, there may be cases in which the setting here will be **off**, so that latch-on will not occur even if you turn **on** the LATCH switch. In such cases, turn this **on**.

**Envelope1, Envelope2, Envelope3**

Each GE provides three Envelopes. They can produce time-variant control of velocity, tempo, duration, pitch bend, and various control changes.

You can specify triggering conditions and latch conditions for each of the three Envelopes of the GE, separately from the Note Trigger and Latch (although many times you will want them to be the same.)

 If the selected GE does not use Envelopes, these settings will have no effect. For information on specific GEs, please see the separate Voice Name List (VNL).

**Envelope Trigger** [Any, AKR, 1st, Dyn]

**Any (Any Note + Dynamic MIDI):** Every note-on will cause triggering; i.e., each note-on will cause the envelope to start from the beginning.

**AKR (1st Note After Key Release + Dynamic MIDI):**

Triggering will occur when the first note-on occurs from a state in which no keys are “on.” Retriggering will not occur if even one note is being pressed.

**1st (1st Only Until Module Stops + Dynamic MIDI):**

After KARMA is turned on, only the first note-on will cause triggering. Subsequent note-ons will not cause triggering.

**Dyn (Dynamic MIDI):** Triggering will be produced by operating the controller specified by Dynamic MIDI (Program 7-7). In this case, note-ons will not cause triggering.

Note: For any of these settings, triggering will be applied by operations of the controller specified for Dynamic MIDI, if “Destination” is set to **Trigger Notes&Envs, Trigger Env1... Trigger Env3**.

**Envelope Latch [Off, Sus1, Rel1, Sus2, Rel2]**

**Off:** The envelope will not be latched. When all keys are released or a Dynamic MIDI trigger is released (note-off), the envelope will move to the release segment.

**Sus1:** Once the envelope is started, it will proceed through attack → decay → sustain → release. If note-off occurs before the envelope reaches the sustain level, the envelope will not begin the release immediately but wait until after reaching the sustain level. Even in the case of a note for which the note-on/off interval is short, the envelope will proceed through attack → decay → sustain → release as if the key was being held for a longer time. If the envelope reaches the sustain level before receiving note-off, it will hold at the sustain level (the same operation as for the Off setting). If the note-off occurs after the envelope reaches the sustain level, the envelope will begin the release when note-off occurs (the same operation as for the Off setting).

**Rel1:** Once the envelope has started, it will proceed through attack → decay → release, regardless of when the note-off occurs. Even if a key is being pressed, the envelope will ignore sustain, and will proceed immediately to the release.

**Sus2:** The envelope will ignore note-off, and will proceed through attack → decay → sustain. Therefore, this setting will never reach the release portion. Other operation is the same as for **Sus1**.

**Rel2:** The same operation as **Rel1**, except will ignore note-off for the purpose of looping, as explained below.

The envelope can be set to repeat as a loop as part of the GE. A looped envelope will be controlled as follows.

**For Sus1 and Rel1,** the envelope will continue repeating as long as the key is held.

**For Sus2 and Rel2,** the envelope will continue repeating even if the key is released.

- 0: **Write Program.** For more information, see “Write Program” on page 147.
- 1: **Exclusive Solo.** For more information, see “Exclusive Solo” on page 147.
- 2: **Copy KARMA Module.** For more information, see “Copy KARMA Module” on page 155.
- 3: **Initialize KARMA Module.** For more information, see “Initialize KARMA Module” on page 156.
- 4: **Copy Scene.** For more information, see “Copy Scene” on page 157.
- 5: **Swap Scenes.** For more information, see “Swap Scene” on page 157.
- 6: **Capture Random Seed.** For more information, see “Capture Random Seed” on page 157.

▼ **7-4: Page Menu Commands**

The number before each command shows its ENTER + number-key shortcut. For more information on these shortcuts, see “ENTER + 0-9: shortcuts for menu commands” on page 147.



## 7-5: GE Real-Time Parameters/Scenes

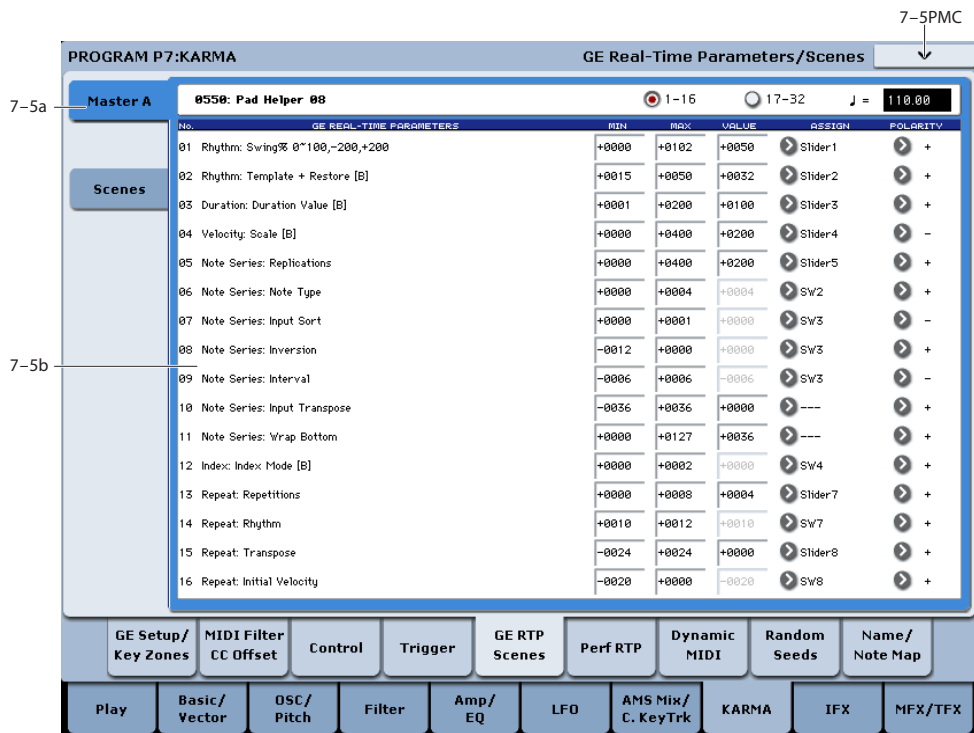

Here you can edit the Real-Time parameters of the GE selected for the KARMA Module. By assigning GE parameters to KARMA Real-Time Controls, you can control the phrase or pattern in real-time while you play.

### 7-5a: GE Number & Name, RTC Select, and Tempo

#### GE Number & Name

**[0000: Arp Model 01 Up/Dn... 2047: Tempo Env Repeats]**

This shows the GE selected for the Module. For more information, please see “0-6b: GE Select” on page 10.

#### GE RTC Select

**[1-16, 17-32]**

This switches the GE realtime parameter display.

**1-16:** GE parameters 1-16 will be displayed.

**17-32:** GE parameters 17-32 will be displayed.

#### ♩ (Tempo)

**[40.00...300.00, EXT]**

For more information, please see “Tempo” on page 5.

### 7-5b: GE Real-Time Parameters

#### GE Parameter 01...32

**[Parameter Name]**

Each GE has up to 32 preset parameters for controlling the phrase or pattern, referred to as GE Real-Time Parameters (or GE RTP). The specific parameters, and the available value ranges, will vary depending on the selected GE.

Each of the GE Real-Time Parameters has a basic value, a controller assignment with polarity, and minimum and maximum values (for setting the range of the selected controller). When you select a new GE, the basic, minimum, and maximum values will be reset to the values saved in the GE, and the controller assignment will be set to the defaults for the GE’s RTC Model.

For details on the individual GE Real-Time parameters, please see the “KARMA GE guide” on page 1019.

#### MIN (Minimum Value)

**[-5000...+5000]**

This sets the parameter value when the selected controller is at its minimum point—for instance, when a slider is at the bottom of its throw. Note that you can reverse the action of the controller by setting this to be higher than the **MAX** value, below.

The available values will depend on the GE Real-Time parameter.

#### MAX (Maximum Value)

**[-5000...+5000]**

This sets the parameter value when the selected controller is at its maximum point—for instance, when a slider is at the top of its throw.

The available values will depend on the GE Real-Time parameter.

#### VALUE

**[-5000...+5000]**

This sets the basic value of the GE parameter, which corresponds to the center position of the controller. It must be within the **MIN** and **MAX** values.

**ASSIGN** [---, **Slider1...8, Slider (SW)1...8, SW1...8, DynaMIDI1...8]**

Here you can assign the controller for the GE Real-Time parameter.

By assigning GE Real-Time Parameter to KARMA Real-Time Controls, they can be controlled in real-time while you play.

---: No assignment.

**Slider1...8:** Assign the parameter to KARMA SLIDERS 1-8. The slider will continuously control the "value."

For example, let's assume that the "Rhythm Swing%" parameter of the selected GE is set to a **MIN** of +0000, and a **MAX** of +0100.

- If you set "Value": +0050, "Assign": **Slider 1**, and **Polarity:+**

Slider 1 at the center position will produce a value of +0050. At minimum the value will be +0000, and at maximum the value will be +0100. Turning the Slider from center toward the minimum will control the value from +0050...+0000, and turning it from center toward the maximum will control the value from +0050...+0100.

- If you set "Value": +0080, "Assign": **Slider 1**, and "Polarity":+

Slider 1 at the center position will produce a value of +0080. At minimum the value will be +0000, and at far maximum the value will be +0100. Turning the slider from center toward the minimum will control the value from +0080...+0000, and turning it from center toward the maximum will control the value from +0080...+0100.

**Slider (SW) 1...8:** Assign the parameter to KARMA SLIDER 1-8. The Slider will switch the value between minimum and maximum only. The minimum to center range of the Slider is off, and the center to maximum is on.

- If you set "Value": +0050, "Assign": **Slider (SW) 1**, and **Polarity:+**

Turning the slider toward the minimum will produce a value of +0000. Turning it to center or maximum will produce a value of +0100.

**SW1...8:** The parameter will be assigned to switch 1-8. The minimum is off, and the maximum is on.

**Note:** the correspondence between the KARMA SLIDERS, SWITCHES and MIDI control change messages can be specified in Global P3-1: Controllers/Scales, Controller. For SW1...8 and Slider (SW) 1...8, a MIDI control change message value of less than 64 will be "off," and 64 or greater will be "on."

**DynaMIDI 1...8:** This corresponds to Dynamic MIDI 1...8.

Select this if you wish to control a GE parameter using the controller selected for **Source** in Dynamic MIDI (7-8). (Set the Dynamic MIDI "Destination" to **RTPParams Control**.)

**POLARITY** [+,-]

This sets the polarity of the selected controller.

**+**: In the case of **Slider 1-8**, moving down from the center will move the value towards the "Minimum" setting, and moving up from the center will move towards the "Maximum" setting. In the case of **Slider (SW) 1-8**, the bottom of the slider throw will be "Minimum," and the top will be "Maximum." In the case of **SW1-8**, the parameter will be "Maximum" when the LED is lit.

**-**: In the case of **Slider1-8**, moving down from the center will move the value towards the "Maximum" setting, and moving up from the center will move towards the "Minimum" setting. In the case of **Slider (SW) 1-8**, the bottom of the slider throw will be "Maximum," and the top will be "Minimum." In the case of **SW1-8**, the parameter will be "Maximum" when the LED is dark.

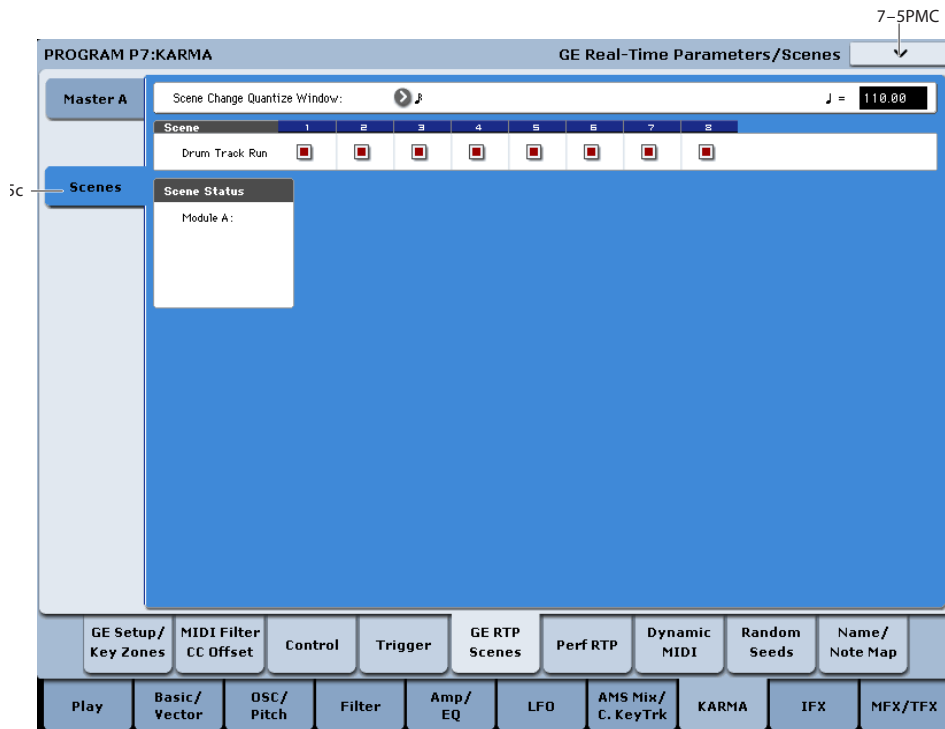



### 7-5c: Scenes

Here you can set a Scene Change Quantize Window that controls a time interval for when the scene changes will occur, and view information about upcoming scene changes.

#### Scene Change Quantize Window

 ... **1 Bar...4 Bars**

Specify the metric division by which scene changes will be quantized. Depending on the setting, this may delay the scene change from occurring until the next beat, next bar, or several bars later.

 ... : Specify the time window as a note value interval relative to the tempo. For triplet-based patterns, you may need to select one of the triplet-based settings if you intend to perform scene changes “off the beat.”

**1 Bar...4 Bars:** Specify the time window as a bar value relative to the tempo, and the time signature of the Performance or the Module’s GE.

Note: if the KARMA T.Sig (Time Signature) is set to something other than “0 GE/TS”, then the specified Time Signature is what will be used to calculate the bar lengths. If the KARMA T.Sig is set to “0 GE/TS” (meaning that the Module’s GE uses its own stored internal time signature), then the bar length is based on the internal stored time signature of the GE. For more information, see “KARMA T.Sig (Time Signature)” on page 7.

Note: Scene changes selected at a timing that is within a 32nd note of the Scene Change Quantize Window setting will be considered “late” (shown by the pink color in the diagram above), and will cause the scene change to occur immediately. If the scene change is later than this, it will be considered “early” (shown by the yellow color in the diagram above), and will occur

at the next metric division corresponding to the Scene Change Quantize Window. (Due to space, not all settings are shown in the diagram.)

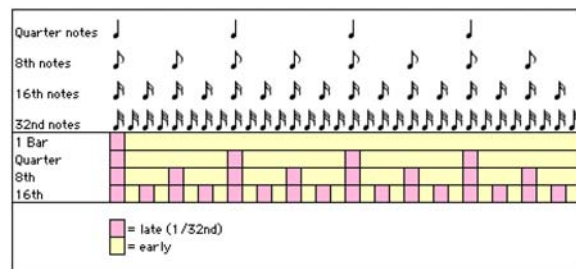

 **(Tempo)** **[40.00...300.00, EXT]**

For more information, please see “Tempo” on page 5.

**Drum Track Run 1...8** **[Off, On]**

These 8 check-boxes determine whether or nor the Drum Track will run for each of the KARMA scenes. For more information, see “Using KARMA and the Drum Track together” on page 243 of the Operation Guide.

#### Scene Status

Displays information related to upcoming scene changes. When using the Scene Change Quantize Window with longer settings such as 1, 2 or 4 bars, you can select a scene change several beats or more in advance of when you want it to occur. The Control Surface and Scene Matrix will change to the new scene immediately, but internally the scene change will not occur until the specified time interval has elapsed. The Scene Status area displays a message indicating a pending scene change, from the current scene to the new scene. You can use this to “cancel” a pending scene change if desired. For example, if you are on Scene 2 and you select Scene 8, the message “2 -> 8” will be displayed. The Scene Matrix and Control

Surface immediately change to Scene 8, but internally the scene change has not yet occurred. You can reselect Scene 2 and thereby cancel the upcoming scene change.

Note: if you have selected a scene change in advance, and it has not yet occurred, the Control Surface and various editing pages such as the KARMA GE Page 0-6 and the Control Surface RT/KARMA Page 0-9d will show the new scene's parameters. Editing them while the scene change is pending will actually be editing the upcoming scene, and you will not hear any changes until the scene change has actually occurred.

### ▼ 7-5: Page Menu Commands

The number before each command shows its ENTER + number-key shortcut. For more information on these shortcuts, see "ENTER + 0-9: shortcuts for menu commands" on page 147.

- 0: **Write Program.** For more information, see "Write Program" on page 147.
- 1: **Exclusive Solo.** For more information, see "Exclusive Solo" on page 147.
- 2: **Copy KARMA Module.** For more information, see "Copy KARMA Module" on page 155.
- 3: **Initialize KARMA Module.** For more information, see "Initialize KARMA Module" on page 156.
- 4: **Copy Scene.** For more information, see "Copy Scene" on page 157.
- 5: **Swap Scenes.** For more information, see "Swap Scene" on page 157.
- 6: **Capture Random Seed.** For more information, see "Capture Random Seed" on page 157.

## 7-6: Perf Real-Time Parameters

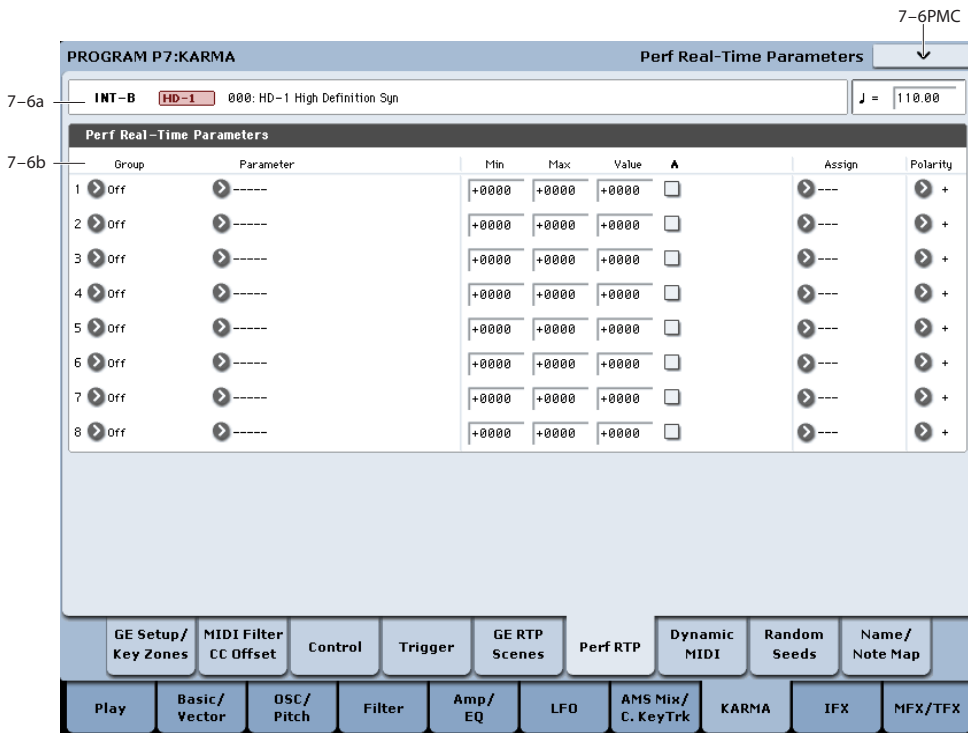

Here you can assign controllers to KARMA Performance Real-Time Parameters (Perf. RTP) outside of the GE Real-Time Parameters that control the internal settings of the GE. Examples include the KARMA Key Zone parameters (Program 7-1b) and KARMA Control and Trigger parameters (Program 7-3, 7-4).

By assigning these to KARMA SLIDERS 1-8 and KARMA SWITCHES 1-8 etc., you can control them in real-time while you play.

**⚠** In Perf Real-Time Parameters 1-8, if you select a parameter by "Group" and "Parameter" and **On (checked)** "Module A," that parameter can no longer be edited as a KARMA Key Zone parameter (Program 7-1b) or KARMA Control and Trigger parameter (Program 7-3, 7-4).

### 7-6a: Program Name and Tempo

For descriptions of these parameters, please see "7-2a: Program Name and Tempo" on page 110.

### 7-6b: Perf Real-Time Parameters

You can set up 8 different Performance Real-Time Parameters, each of which has an identical set of parameters, as described below.

## Real-Time Parameters 1...8

**Group** [Off, PE, Mix, Control, Trigger, Key Zones, Random Seeds]

Selects the group of parameters that you wish to choose a "Parameter" from. The KARMA parameters are divided into six groups.

**Parameter** [---, Time Signature... Retrigger Each Time]

Indicates the parameter that you wish to assign. The parameters that can be selected will differ according to the "Group" setting, above.

**Min (Minimum Value)** [-8192...+8192]

This sets the parameter value when the selected controller is at its minimum point—for instance, when a slider is at the bottom of its throw. Note that you can reverse the action of the controller by setting this to be higher than the MAX value, below.

The available values will depend on the selected parameter. When a parameter is selected, the minimum parameter value will be set as the default.

**Max (Maximum Value)** [-8192...+8192]

This sets the parameter value when the selected controller is at its maximum point—for instance, when a slider is at the top of its throw. The available values will depend on the selected parameter.

**Value** [-8192...+8192]

Specifies the value of the selected KARMA parameter. If you turn on "A (Module A)" and select "Parameter," this will be set as the current value of the parameter (set in 7-3 and 7-4). The value you specify here will be the center value when you use "Assign" to control the parameter from a KARMA SLIDER, etc. The value will not be available when assigning to Switches or Slider (SW).

**A (Module A)** [Off, On]

Specifies the module to which the settings of RT Parm 1-8 will apply. In Program mode, only one KARMA Module (Module A) can be used. Thus in Program mode, you can turn the RT Parm 1-8 settings on/off.

**On (checked):** RT Parm settings will be valid.

**Off (unchecked):** RT Parm settings will be ignored.

**Assign** [---, Slider1...8, Slider (SW) 1...8, SW1...8, DynaMIDI1...8]

Assigns the selected parameter to a controller. If you assign a parameter to KARMA Real-Time Controls, you can control it in real-time while you play.

For more information, see "ASSIGN" on page 121.

**Polarity** [+,-]

Specifies the polarity used when you operate the KARMA Real-Time Controls that you selected for "Assign."

For more information, please see "POLARITY" on page 121.

## Group: PE (Performance)

**Time Signature** [+0000...+0048]

Assigns the "KARMA T.Sig" (Program 7-1a) function.

+0000: Off

+0001...+0048: Corresponds to 1/4-16/16.

For more information, see "KARMA T.Sig (Time Signature)" on page 108.

 If you select Time Sig. as a parameter for assignment, you will not be able to set "A (Parm Module A)."

## Group: Mix

**Transpose** [-0036...+0036]

Assigns the "Transpose" (Program 7-3b) function. Control the transposition in semitone steps.

**Transpose Octave** [-0036...+0036]

Assigns the "Transpose" (Program 7-3b) function. Control the transposition in octave steps.

**Transpose Octave/5th** [-0036...+0036]

Assigns the "Transpose" (Program 7-3b) function. Control the transposition in steps of an octave and a fifth.

## Group: Control

**Force Range** [+0000...+0004]

Assigns the "Force Range" (Program 7-3b) function.

+0000: Off

+0001: Lowest

+0002: Highest

+0003: C3-B3[1]

+0004: C3-B3[2]

For more information, see "Force Range" on page 113.

**Force Range Wrap** [+0000...+0011]

Assigns the "Force Range Wrap" (Program 7-3b) function.

+0000: C...0011: B

For more information, see "Force Range Wrap" on page 113.

**Root Position** [+0000, +0001]

Assigns the "Root Position" (Program 7-3b) function.

+0000: Off

+0001: On

For more information, see "Root Position" on page 114.

**Clock Advance Mode** [+0000...+0003]

Assigns the "Mode (Clock Advance Mode)" (Program 7-3b) function.

+0000: Auto

+0001: Dyn

+0002: Auto+Dyn1

+0003: Auto+Dyn2

For more information, see "Mode" on page 115.

**Clock Advance Size** [+0000...+0011]

Assigns the "Size (Clock Advance Size)" (Program 7-3b) function.

+0000...+0010:

+0011: Event

For more information, see "Size" on page 115.

**CA Vel. Sensitivity** [+0001...+0127]

Assigns the "Velocity Sense Bottom" (Program 7-3b) function.

For more information, see "Velocity Sense Bottom" on page 115.

**CA Chord Trigger Mode** [+0000...+0004]

Assigns the "Chord Trigger Mode" (Program 7-3b) function.

+0000: Off

+0001: 1st

+0002: Chrd1

+0003: Chrd2

+0004: Chrd3

For more information, see "Chord Trigger Mode" on page 115.

**Note Map Mode** [+0000...+0003]

Assigns the "Mode (Note Map Mode)" (Program 7-3b) function.

+0000: Off

+0001: On-Main

+0002: On-Repeat

+0003: On-All

For more information, see "Mode (Note Map Mode)" on page 115.

**Note Map Table** [+0000...+0064]

Assigns the "Table (Note Map Table)" (Program 7-3b) function.

+0000: Custom

+0001...+0064: Global Tables 1...Maj 7 -> oct

For more information, see "Table (Note Map Table)" on page 116.

**Note Map Transpose** [-0012...+0012]

Assigns the "Transpose (Note Map Transpose)" (Program 7-3b) function.

For more information, see "Transpose (Note Map Transpose)" on page 116.

**Note Map Chord Track** [+0000, +0001]

Assigns the "Chord Track (Note Map Chord Track)" (Program 7-3b) function.

+0000: Off

+0001: On

For more information, see "Chord Track (Note Map Chord Track)" on page 116.

**Note Map Kbd Track** [+0000, +0001]

Assigns the "Keyboard Track (Note Map Kbd Track)" (Program 7-3b) function.

+0000: Off

+0001: On

For more information, see "Keyboard Track (C2 Ref) (Note Map Kbd Track)" on page 116.

**Group: Trigger**

**Quantize Trigger** [+0000, +0001]

Assigns the "Quantize Trigger" (Program 7-4b) function.

+0000: Off

+0001: On

For more information, see "Quantize Trigger" on page 117.

**Quantize Window** [+0000...+0005]

+0000...+0005: 16th triplet to Quarter Note

Assigns the "Quantize Window" (Program 7-4b) parameter. For more information, see "Quantize Window" on page 117.

**Update On Release** [+0000, +0001]

Assigns the "Update On Release" (Program 7-4b) function.

+0000: Off

+0001: On

For more information, see "Update On Release" on page 117.

**Delay Start** [+0000...+0025]

Assigns the "Delay Start" (Program 7-4b) function.

+0000: Off

+0001: Fixed

+0002...+0025:

For more information, see "Delay Start" on page 118.

**Delay Start ms** [+0000...+5000]

Assigns the "Delay Start Fixed" (Program 7-4b) function.

See "Delay Start Fixed" p.118

**Note Trigger** [+0000...+0003]

Assigns the "Note Trigger" (Program 7-4b) function.

+0000: Any

+0001: AKR

+0002: 1st

+0003: Dyn

For more information, see "Note Trigger" on page 118.

**Note Latch** [+0000, +0001]

Assigns the "Note Latch" (Program 7-4b) function.

+0000: Off

+0001: On

For more information, see "Note Latch" on page 118.

**Env1 Trigger** [+0000...+0003]

**Env2 Trigger** [+0000...+0003]

**Env3 Trigger** [+0000...+0003]

Assigns the Envelope “Trigger” (Program 7–4b) functions.

+0000: Any

+0001: AKR

+0002: 1st

+0003: Dyn

For more information, see “Envelope Trigger” on page 118.

**Env1 Latch Mode** [+0000...+0004]

**Env2 Latch Mode** [+0000...+0004]

**Env3 Latch Mode** [+0000...+0004]

Assigns the “Latch” (Program 7–4b) function.

+0000: Off

+0001: Sus1

+0002: Rel1

+0003: Sus2

+0004: Rel2

For more information, see “Envelope Latch” on page 119.

**Group: Zone**

**Thru Inside Zone** [+0000, +0001]

Assigns the “Thru In Zone” (Program 7–1a) function.

+0000: Off

+0001: On

For more information, see “Thru In Zone” on page 108.

**Thru Outside Zone** [+0000, +0001]

Assigns the “Thru Out Zone” (Program 7–1a) function.

+0000: Off

+0001: On

For more information, see “Thru Out Zone” on page 109.

**Key Zone Bottom** [+0000...+0127]

Assigns the “Bottom (Key Zone Bottom)” (Program 7–1a) function.

+0000...+0127: C-1–G9 (corresponds to note numbers)

For more information, see “Bottom (Key Zone Bottom)” on page 108.

**Key Zone Top** [+0000...+0127]

Assigns the “Top (Key Zone Top)” (Program 7–1a) function.

+0000...+0127: C-1–G9 (corresponds to note numbers)

For more information, see “Top (Key Zone Top)” on page 108.

**Transpose In Thru** [–0036...+0036]

Assigns the “Transpose In Zone” (Program 7–1a) function. This controls transposition of the note data from the keyboard within the Key Zone, in semitone steps.

For more information, see “Transpose In Zone” on page 109.

**Transpose Out Thru** [–0036...+0036]

Assigns the “Transpose Out Zone” (Program 7–1a) function. This controls the transposition of note data from the keyboard outside the Key Zone, in semitone units.

For more information, see “Thru Out Zone” on page 109.

**Transpose Octave In Thru** [–0036...+0036]

Assigns the “Transpose In Zone” (Program 7–1a) function. This controls the transposition of note data from the keyboard within the Key Zone, in octave units.

**Transpose Octave Out Thru** [–0036...+0036]

Assigns the “Transpose Out Zone” (Program 7–1a) function. This controls the transposition of note data from the keyboard outside the Key Zone, in octave units.

**Transpose Octave/5th In Thru** [–0036...+0036]

Assigns the “Transpose In Zone” (Program 7–1a) function. This controls the transposition of note data from the keyboard within the Key Zone, in units of an octave and a fifth.

**Transpose Octave/5th Out Thru** [–0036...+0036]

Assigns the “Transpose Out Zone” (Program 7–1a) function. This controls the transposition of note data from the keyboard outside the Key Zone, in units of an octave and a fifth.

**Group: Random**

**Start Seed** [–8192...0...+8191]

Assigns the “Start Seed” (Program 7–8b) function.

+0000: Random

**Other than +0000:** Any desired “Start Seed” value. However, you cannot select values outside the range of –8192 to +8191 when changing the value in this way.

For more information, see “Start Seed” on page 130.

Note: If the “Start Seed” value is set to a value outside of this range when you first assign it as a RT Parameter, it will be limited to either end of the range.

**Freeze Loop Length** [+0000...+0032]

Assigns the “Freeze Loop Length” function (see “Freeze Loop Length” on page 131). This specifies the number of measures (bars) in the phrases that are repeatedly generated by the KARMA Module. After being triggered, the Module will generate a phrase of the number of measures you specify here, and will then repeat that phrase.



**Freeze Loop Length + Reset** [+0000...+0032]

Like **Freeze Loop Length**, above, this also assigns the “Freeze Loop Length” function (see “Freeze Loop Length” on page 131). However, when this is used, and the Start Seed is set to some other value than 0: Random, changing the Freeze Loop Length to any value except 0: Off will reset the Start Seed internally to the indicated value, thereby restoring the original phrase at the next downbeat without retriggering it from the keyboard.

Normally, if you were generating a randomized riff from a particular Start Seed value, setting Freeze Loop Length to 0: Off would cause the phrase to continue randomizing from its current internal position. If you then set the Freeze Loop Length to some other value than 0: Off, thereby looping the phrase, it does not automatically reset the Start Seed until you retrigger it from the keyboard (depending on Trigger settings). By using “Freeze Loop Length + Reset,” a change in the Freeze Loop Length can additionally reset the internal Start Seed and therefore generate the same phrase as before, allowing instantaneous switching between “randomized” and “preset” phrases.

**Retrigger Each Time** [+0000, +0001]

Assigns the “Retrigger Each Time” function (see “Retrigger Each Time” on page 131).

+0000: Off

+0001: On

For more information, see “Retrigger Each Time” on page 131.

---

**▼ 7-6: Page Menu Commands**

The number before each command shows its ENTER + number-key shortcut. For more information on these shortcuts, see “ENTER + 0-9: shortcuts for menu commands” on page 147.

- **0: Write Program.** For more information, see “Write Program” on page 147.
- **1: Exclusive Solo.** For more information, see “Exclusive Solo” on page 147.
- **2: Copy KARMA Module.** For more information, see “Copy KARMA Module” on page 155.
- **3: Initialize KARMA Module.** For more information, see “Initialize KARMA Module” on page 156.
- **4: Copy Scene.** For more information, see “Copy Scene” on page 157.
- **5: Swap Scenes.** For more information, see “Swap Scene” on page 157.
- **6: Capture Random Seed.** For more information, see “Capture Random Seed” on page 157.

## 7-7: Dynamic MIDI

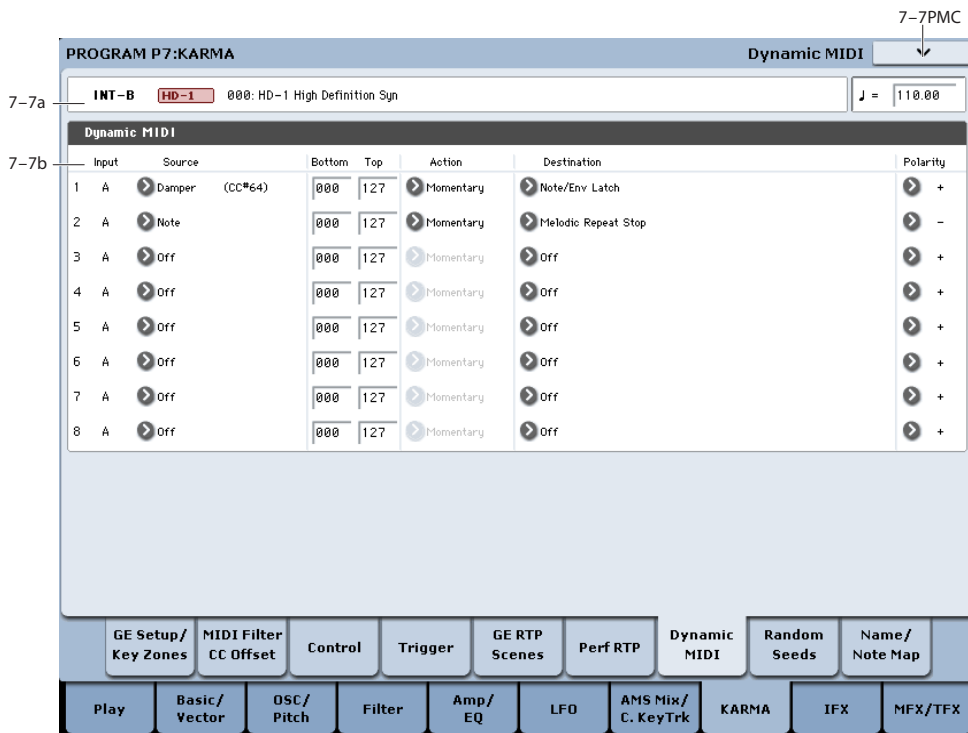

**Dynamic MIDI** lets you use the KRONOS's controllers and MIDI control messages to modulate specific KARMA functions.

You can take advantage of this to control KARMA in various ways while you play. For example, you can use note-ons to advance the KARMA clock (Manual Advance), or a joystick to Trigger the start of the patterns. You can use a foot pedal to control Auto Transpose, or a damper pedal to control the KARMA Latch settings.

### 7-7a: Program Name and Tempo

For descriptions of these parameters, please see "7-2a: Program Name and Tempo" on page 110.

### 7-7b: Dynamic MIDI

You can set up 8 different Dynamic MIDI routings, each of which has an identical set of parameters, as described below.

#### Dynamic MIDI 1...8

##### Input (Input Module) [A]

In Program mode this is fixed at A. This is because only KARMA Module A is used. This setting cannot be changed.

##### Source [Off, JS+Y (CC#01) ...Velocity Outside Zone]

Indicates the controller or action. that will be the Dynamic MIDI source. For more information, see "Dynamic MIDI Sources & Destinations" on page 1109.

##### Bottom (Range Bottom) [000...127]

Specifies the lower limit for the value controlled by **Source**. If **Source** is **Short Note**, **Note No.**, **White Note**, or **Black Note**, the numeric value corresponds to the note numbers C-1-G9.

##### Top (Range Top) [000...127]

Specifies the upper limit for the value controlled by **Source**. If **Source** is **Short Note**, **Note No.**, **White Note**, or **Black Note**, the numeric value corresponds to the note numbers C-1-G9.

##### Action (Source Action) [Momentary, Toggle, Continuous]

Specifies the operation mode for Dynamic MIDI.

**Momentary:** The parameter will be controlled as a momentary switch. For example if **Source** is JS+Y (CC#01), the parameter will normally be **off**, and will be **on** when you move the joystick.

**Note:** If **Polarity** is + and the source controller value is less than or equal to the **Bottom** setting, the destination will be off. If the controller value is greater than or equal to the **Top** setting, it will be on.

##### Example

When **Bottom:** 000 and **Top:** 127

The controller value and the on/off status are related as follows.

000 → 127: **on** at 127

127 → 000: **off** at 000

**Toggle:** The parameter will be controlled as a toggle switch. For example, if **Source** is JS+Y (CC#01), moving it to the top and releasing it one time will turn the destination on, and moving it to the top and releasing

it again will turn the destination off. If **Polarity** is +, on and off will alternate each time the source controller value exceeds the **Top** value after having passed through the **Bottom** value.

**Example**

When **Bottom: 0** and **Top: 127**

The controller value and the on/off status are related as follows.

- 000 → 127: **on** → **off** at 127
- 127 → 000 → 127: **off** → **on** at 127
- (127 → 001 → 127: no change)

**Continuous:** The parameter will be controlled continuously, over the range specified by **Bottom** and "Top." For example, if bottom is 25 and **Top** is 100, the destination value will be smoothly operated when the controller's value moves between 25 and 100. Values outside that range will cause no further change.

**Note:** The operating modes that can be selected are limited by the "Destination." For more information, see "Dynamic MIDI Sources & Destinations" on page 1109.

**Destination [Off, RT Params Control...Buffer Latch]**

Selects the Dynamic MIDI Control destination function. For more information, see "Dynamic MIDI Destinations" on page 1111.

**Polarity [+ , - , +/- , -/+]**

Specifies the Dynamic MIDI polarity.

For example if you set **Polarity** to + and the Source is **KARMA SLIDER 1**, moving the Slider 1 from min to max will change the value from 0 → 127. If you set **Polarity** to -, the same Slider 1 movement will change the value from 127 → 0.

**▼ 7-7: Page Menu Commands**

The number before each command shows its ENTER + number-key shortcut. For more information on these shortcuts, see "ENTER + 0-9: shortcuts for menu commands" on page 147.

- 0: **Write Program.** For more information, see "Write Program" on page 147.
- 1: **Exclusive Solo.** For more information, see "Exclusive Solo" on page 147.
- 2: **Copy KARMA Module.** For more information, see "Copy KARMA Module" on page 155.
- 3: **Initialize KARMA Module.** For more information, see "Initialize KARMA Module" on page 156.
- 4: **Copy Scene.** For more information, see "Copy Scene" on page 157.
- 5: **Swap Scenes.** For more information, see "Swap Scene" on page 157.
- 6: **Capture Random Seed.** For more information, see "Capture Random Seed" on page 157.

**7-8: Random Seeds**

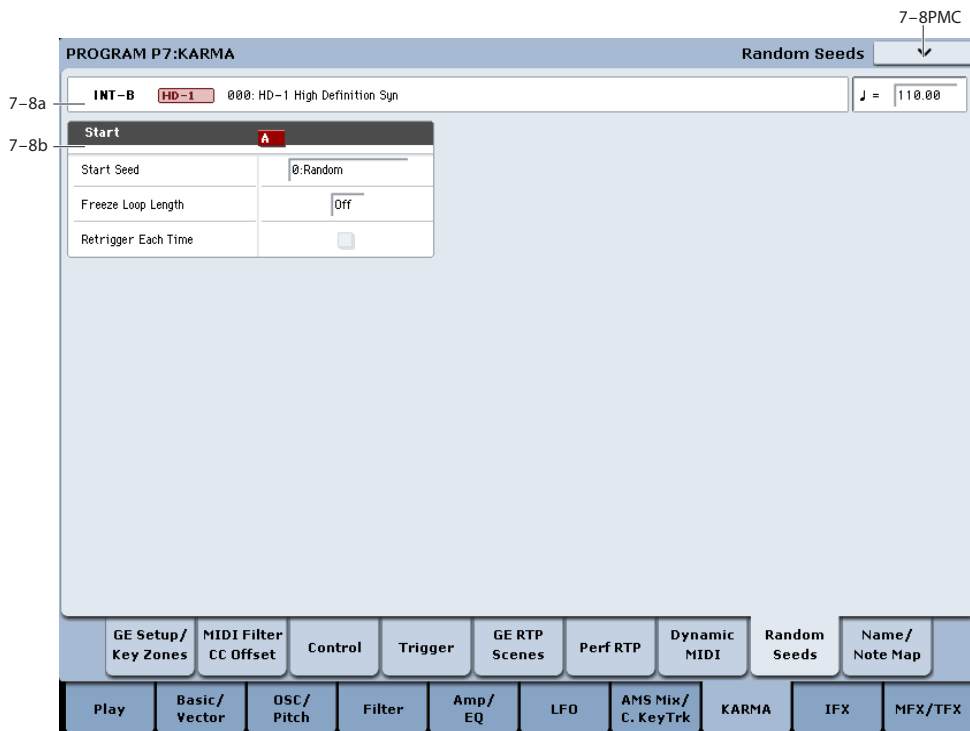

The Random Seeds page allows you to control some of the randomizable characteristics of a Module's GE.

You can freeze (capture) the endlessly varying phrases generated by KARMA's randomize features.

## 7-8a: Program Name and Tempo

For descriptions of these parameters, please see “7-2a: Program Name and Tempo” on page 110.

## 7-8b: Start

By using the “Capture Random Seed” (see “Capture Random Seed” on page 157), “Start Seed”, and “Freeze Loop Length” parameters, you can loop a randomly changing phrase, or play the same phrase each time you trigger it. These capabilities are collectively called **Freeze Randomize**. You can also store a Program or Combination with these settings, so that it will always play the same randomized phrase or pattern when you first call it up.

⚠ Not all GEs have been programmed to utilize KARMA’s randomization capabilities. If no randomization has been programmed as part of the GE, changing these parameters will appear to have no effect.

### Start Seed [-2147483648...0: Random...+2147483647]

Specifies the seed that is used by the KARMA Module to generate the random phrase.

Note: “Seed” is the source data from which the randomizations are created. “Start Seed” is the seed that will be used each time a trigger occurs.

**0: Random:** A different phrase will be generated each time the trigger occurs. Within the KARMA Module, a different “Start Seed” value is specified randomly each time the trigger occurs.

**Any value other than Random:** The same phrase will be generated each time the trigger occurs. Different values for the Start Seed parameter will produce different phrases, but the same phrase will always be generated if the Start Seed value is the same.

### How the “Start Seed” value affects the phrase

As an example, we will use Program USER-B061: Widow Maker to see how different “Start Seed” settings will affect the phrase.

1. In Program mode, select USER-B061: Widow Maker.  
This is an EXi Program, using two AL-1s to create a lead synth sound. KARMA is programmed to play a phrase.
2. Turn on the front-panel KARMA ON/OFF switch.
3. Press the Common button, to see the EXi Common pages.
4. Select the P7-8: Random Seeds page.
5. Press the Common button to access the 7-4: Module Parameters- Trigger page, and set “Note Trigger” to Any.

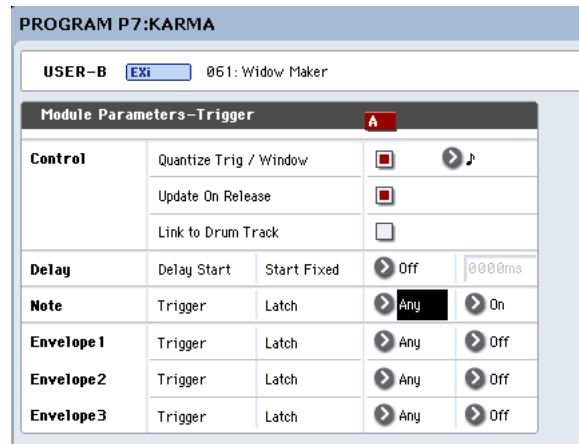

6. Turn the front panel KARMA LATCH switch on.
7. Go to the P7-8: Random Seeds page.
8. Make sure that the KARMA module’s “Start Seed” value is 0:Random.  
If “Start “Seed” is other than 0:Random, set it to 0:Random.

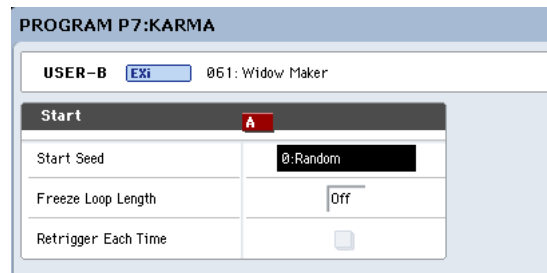

The KARMA module will generate a lead synth phrase.

9. Go to the P1-9 Pads page, and use pad 1 to produce a trigger several times at a fixed interval (one or two seconds). When doing so, pay attention to the phrase that begins immediately after triggering. A different phrase will begin playing each time triggering occurs.
10. Return to the P7-8: Random Seeds page, and set “Start Seed” to any value other than 0:Random. For this example, we’ll set it to +1.
11. As you did in step 9, trigger pad 1 several times, and pay attention to the phrase that begins immediately after triggering. The same phrase will begin playing each time triggering occurs.
12. Return to the P7-8: Random Seeds page, and set “Start Seed” to a value other than +1, and repeat the actions you performed in step 4.

The phrase will be different than when “Start Seed” was +1, but the same phrase will begin playing each time triggering occurs.

Note: If you set “Start Seed” to **0: Random**, and execute “Capture Random Seed” after triggering, the “Start Seed” value that was internally set within the module at the time of triggering will be specified here. While listening to the phrases that change randomly at each trigger, you can execute this when you hear a phrase that you want to reproduce. In conjunction with the “Freeze Loop Length” and “Retrigger Each Time” settings, you can also loop a phrase that you like.

For more information, see “Checking the Freeze Randomize function, and performing “Capture Random Seed”” on page 157.

**Freeze Loop Length** [Off, 01...32]

Specifies the number of measures in the phrases that are repeatedly generated by the KARMA Module. After being triggered, the module will generate a phrase of the number of measures you specify here, and will then repeat that phrase. If you set this to Off, the phrase will not be repeated.

The table below and the explanations that follow describe how various combinations of “Start Seed” and “Freeze Loop Length” settings will affect the phrase or control data that is randomly generated by the KARMA Module each time triggering occurs, according to the GE settings you are using.

**1. “Start Seed”: 0: Random, “Freeze Loop Length”: Off (unchecked)**

The phrase will change randomly each time triggering occurs. Each time the phrase repeats, it will change randomly. For example, suppose there is a GE that, if you input C-D-E-F, will randomly vary the order of notes, and repeatedly play four notes in each measure. When you trigger this GE, it produces notes in a random order of (for example) C-D-E-F, C-C-D-F, F-D-C-E.... When you trigger this GE again, it produces a different random phrase of (for example) E-D-C-C, C-C-D-D, C-D-C-E....

**2. “Start Seed”: any value, “Freeze Loop Length”: Off**

Each time triggering occurs, the same phrase will be generated. Different “Start Seed” values cause different phrases to be generated. The phrase will change randomly each time it repeats, but the same phrase will always be generated each time you retrigger with a given “Start Seed” value. This lets you select any desired one of more than four billion (!) different phrase variations. For example, suppose there is a GE that, if you input C-D-E-F, will randomly vary the order of notes, and repeatedly play four notes in each measure. When you trigger this GE, it produces notes in a random order of (for example) C-D-D-C, D-C-E-C, D-E-C-D.... Even if you trigger this GE again, it reproduces the same phrase of C-D-D-C, D-C-E-C, D-E-C-D.... If you change the “Start Seed” value, a different phrase will be generated; for example, E-E-C-D, D-C-C-C, E-E-E-E....

**3. “Start Seed”: 0: Random, “Freeze Loop Length”: 1...32**

The phrase will change randomly each time triggering occurs. However, that phrase will loop (repeat) for the number of measures you specified in “Freeze Loop Length.” The same phrase will continue looping until you trigger the GE again. When you trigger the GE again, a different phrase will loop. For example, suppose there is a GE that, if you input C-D-E-F, will randomly vary the order of notes, and repeatedly play four notes in each measure. If you set “Freeze Loop Length” to 1 (measure) and trigger this GE, the same four notes will continue looping (e.g., F-E-D-C, F-E-D-C, F-E-D-C, ...). When you trigger it again, a different

phrase will loop (e.g., D-D-C-C, D-D-C-C, D-D-C-C, ...). (See “Retrigger Each Time,” below.)

**4. “Start Seed”: any value, “Freeze Loop Length”: 1...32**

The same phrase will play each time you trigger the GE. That phrase will loop for the number of measures you specified in “Freeze Loop Length.” For example if you select a program or combination, and make these settings for a KARMA Module that generates random changes each time it is triggered, the exact same phrase will loop every time. The phrase that is looped will be different if you change the “Start Seed” value. For example, suppose there is a GE that, if you input C-D-E-F, will randomly vary the order of notes, and repeatedly play four notes in each measure. If you set “Freeze Loop Length” to 1 (measure) and trigger this GE, the same four notes will loop (e.g., D-E-E-C, D-E-E-C, D-E-E-C, ...). Even if you trigger the GE again, the same phrase (D-E-E-C, D-E-E-C, D-E-E-C, ...) will be reproduced. If you change the “Start Seed” value, a different phrase (e.g., C-C-E-E, C-C-E-E, C-C-E-E, ...) will loop. (See “Retrigger Each Time,” below.)

**Retrigger Each Time** [Off, On]

When set to **On (checked)**, every time the specified loop length is completed, the Phase Pattern, Envelopes, and Indexes will retrigger as if the keyboard itself was retriggered. This means that the notes in the phrase will be restarted according to the Note Trigger settings (☞ “Note Trigger” on page 118) and the applicable internal settings of the GE, and any envelopes will be retriggered according to the Envelope Trigger/Latch settings (☞ “Envelope Trigger” on page 118, “Envelope Latch” on page 119)

When **Off (unchecked)**, the overall length of the internal GE Phase Pattern controls when the loop will be retriggered. For example, if the Phase Pattern is 8 bars, and the “Freeze Loop Length” is set to 2 bars, then the randomizations will reset every 2 bars (controlling the rhythm and movement of notes, for example), but the melody and envelopes may not trigger from the beginning until every 8 bars is completed. (☞ “Checking the Freeze Randomize function, and performing “Capture Random Seed”” on page 157)

⚠ Not available unless “Freeze Loop Length” is set to something other than **Off (unchecked)**.

Note: In some cases, the two settings may sound the same, depending on the internal settings of the GE.

**▼ 7-8: Page Menu Commands**

The number before each command shows its ENTER + number-key shortcut. For more information on these shortcuts, see “ENTER + 0-9: shortcuts for menu commands” on page 147.

- 0: **Write Program**. For more information, see “Write Program” on page 147.
- 1: **Exclusive Solo**. For more information, see “Exclusive Solo” on page 147.
- 2: **Copy KARMA Module**. For more information, see “Copy KARMA Module” on page 155.

- 3: **Initialize KARMA Module.** For more information, see “Initialize KARMA Module” on page 156.
- 4: **Copy Scene.** For more information, see “Copy Scene” on page 157.
- 5: **Swap Scenes.** For more information, see “Swap Scene” on page 157.
- 6: **Capture Random Seed.** For more information, see “Capture Random Seed” on page 157.

## 7-9: Name/Note Map

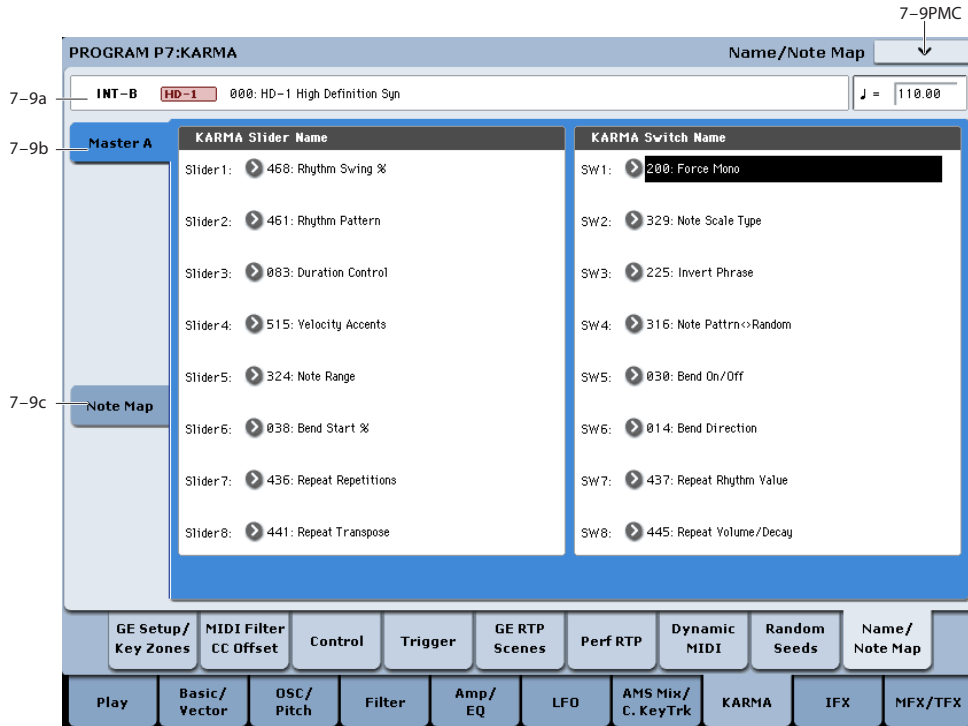

Here you can assign the names for KARMA SLIDERS 1-8 and KARMA SWITCHES 1-8, view Global Note Map Tables, and edit the Custom Note Map Table stored with the Program.

### 7-9a: Program Name and Tempo

For descriptions of these parameters, please see “7-2a: Program Name and Tempo” on page 110.

### 7-9b: Module A

Here you can assign the names for KARMA SLIDERS 1-8 and KARMA SWITCHES 1-8.

The RTC Models include appropriate names for the sliders and switches. However, you may wish to edit the names if you modify the control assignments, or create new ones.

**Slider1...Slider8** [000: (no name)...  
571: Waveform Select [16]]

Selects the name for the KARMA SLIDERS.

**Switch1...Switch8** [000: (no name)...  
571: Waveform Select [16]]

Selects the name for the KARMA SWITCH.

**Note:** The Slider and Switch names can also be automatically assigned to new control assignments using the Page Menu “Auto Assign KARMA RTC Name” command. For more information, see “Auto Assign KARMA RTC Name” on page 148.

### 7-9c: Note Map

Note Maps allow notes being generated by the GE to be selectively remapped to other notes, or removed completely (changed into rests). Here you can view Global Note Map Tables, and edit the Custom Note Map Table that is stored with each Program. The Note Map Table is assigned in Module Parameters-Control: Note Map ( see “Note Map” on page 115).

#### Table [Custom, sidestick/rides1...maj7->oct]

There are 64 Global Note Map Tables provided in the system which cannot be edited, and provide a wide variety of preset note-remapping functions. There is also a single Custom Note Map Table stored in each Program, Combi, and Sequence.

When “Table” = Custom, you can edit the Custom Table using the “In” and “Out” parameters below. When “Table” is one of the 64 Global Tables, you cannot edit it.



**In (Note In)**

[C-1...G9]

Specifies a note number (of data being generated by the GE) that you want to map to a different note or to remove (change to a rest).

**Note:** When “In” is selected, you can hold down the ENTER switch and press a note on the keyboard to set the “In” field to that note.

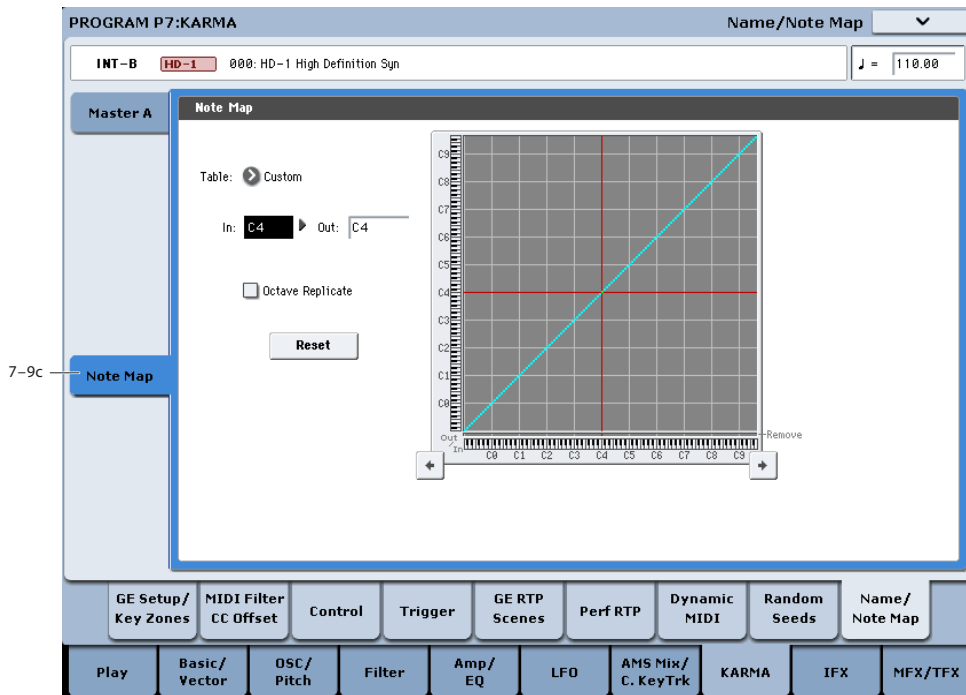

**Out (Note Out)**

[Remove, C-1...G9]

Specify what will be done with the note you specified in the “In” field.

**Remove:** The note specified by “In” will be removed from the output data (and changed to a rest).

**C1...G9:** The note specified by “In” will be converted to the note number you specify here, and sent to the tone generator.

**Note:** When “Out” is selected, you can hold down the ENTER switch and press a note on the keyboard to set the “Out” field to that note.

**Table Grid** This area graphically shows the overall “In” and “Out” settings in visual form.

The horizontal axis (X-axis) corresponds to the incoming note numbers, and the vertical axis (Y-axis) corresponds to the outgoing note numbers. The note transmitted for each received note is shown by the light blue pixels. Notes that are being removed from the incoming data are shown in yellow pixels in the bottom “Remove” row. A straight diagonal line represents no change (what goes in is passed through without modifications).

You can use the buttons located below the graphic to change the “In” note number up or down.

**Octave Replicate**

[Off, On]

When On (checked), any edit that you make within an octave will be made in **every** octave. This is mainly for applying the table to Melodic GEs, where you want to do something like remove every minor third, remap every fourth to a fifth, etc., and have that change take place in every octave.

**Reset**

[button]

Restores the current table to “linear/no change” (a diagonal line).

▼ **7-9: Page Menu Commands**

The number before each command shows its ENTER + number-key shortcut. For more information on these shortcuts, see “ENTER + 0-9: shortcuts for menu commands” on page 147.

- 0: **Write Program.** For more information, see “Write Program” on page 147.
- 1: **Exclusive Solo.** For more information, see “Exclusive Solo” on page 147.
- 2: **Copy KARMA Module.** For more information, see “Copy KARMA Module” on page 155.
- 3: **Initialize KARMA Module.** For more information, see “Initialize KARMA Module” on page 156.
- 4: **Copy Scene.** For more information, see “Copy Scene” on page 157.
- 5: **Swap Scenes.** For more information, see “Swap Scene” on page 157.
- 6: **Capture Random Seed.** For more information, see “Capture Random Seed” on page 157.
- 7: **Auto Assign KARMA RTC Name.** For more information, see “Auto Assign KARMA RTC Name” on page 148.
- 9: **Copy Note Map.** For more information, see “Copy Note Map” on page 148.



## Program P8: Insert Effect

These pages let you can make settings for the insert effects. For instance, you can:

- Send the output of a oscillator to an insert effect
- Route a sound to an insert effect

- Make detailed settings for insert effects
- Make common LFO settings for effects

For more information, please see “Effect Guide” on page 857.

## 8-1: Routing

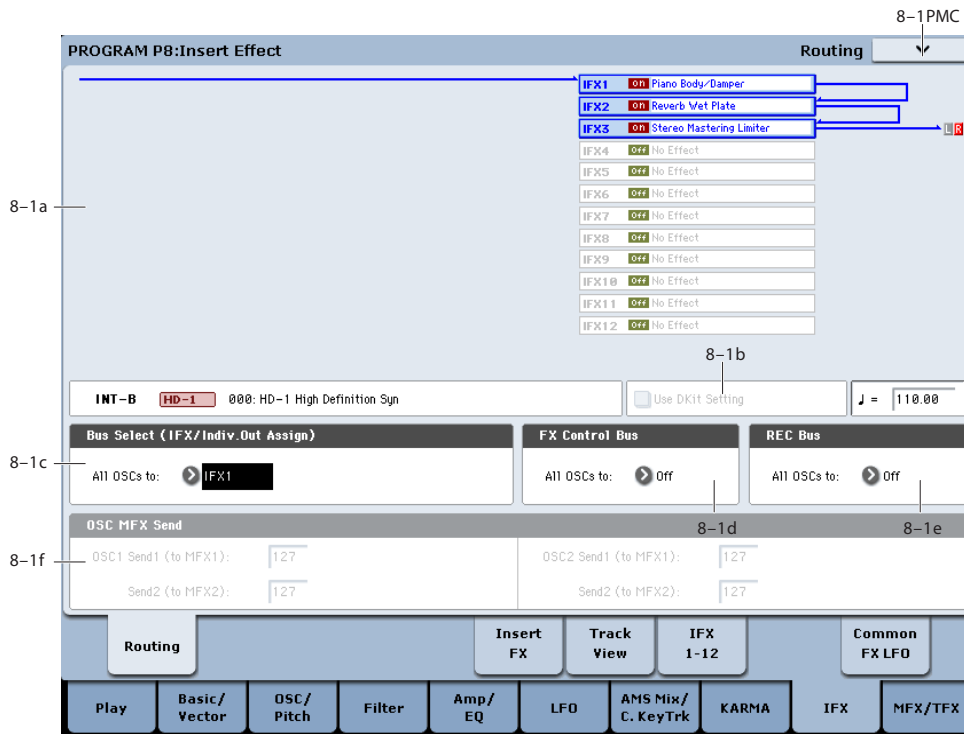

### 8-1a: Routing Map

This graphic shows an overview of the insert effects, including the routing of the oscillators to the effects, the effects names and on/off status, chaining between the effects, and the output bus to which the insert effects are themselves routed.

This page lets you adjust the routing of the oscillators to the insert effects. To adjust the other settings shown in this graphic, see “8-5: Insert FX,” as described on page 137.

*Note:* Drum Track routing is handled separately. For more information, see “1-3f: Bus” on page 44.

### 8-1b: Program Information & Use DKit

**Bank** [INT-A...G, USER-A...G and AA...GG]

**Program Name** [000...127/001...128: Name]

**Tempo** (♩) [040.00...300.00, EXT]

This area displays information about the program selected for editing, including the Program Bank, number, and name, and the tempo used for LFOs, effects, and KARMA.

### Use Dkit Setting

[Off, On]

This is shown if **Oscillator Mode** is set to **Drums** or **Double Drums**. If **Oscillator Mode** is set to **Single** or **Double**, it is ignored. For more information, please see “Oscillator Mode” on page 36.

**On (checked):** Drum Kits can have different **Bus Select**, **FX Control Bus**, **Send 1**, and **Send 2** settings (Global 5-3b) for each note. When **Use Dkit Setting** is **On**, these per-key settings will be used. You can use this to apply individual insert effects to specific drum instruments, or to send specific drum instruments to individual outputs.

*Tip:* Most of the factory Drum Kits use standard **Bus Select** settings, as detailed below:

Snares → IFX1

Kicks → IFX2

Toms → IFX3

Cymbals → IFX4

Percussion, etc. → IFX5

**Off (unchecked):** The Program’s normal settings for **Bus Select**, **FX Control Bus**, and **OSC MFX Send** will be used; see below for more information on these parameters. All drum instruments will be sent to the same busses.

Use Dkit Setting = On

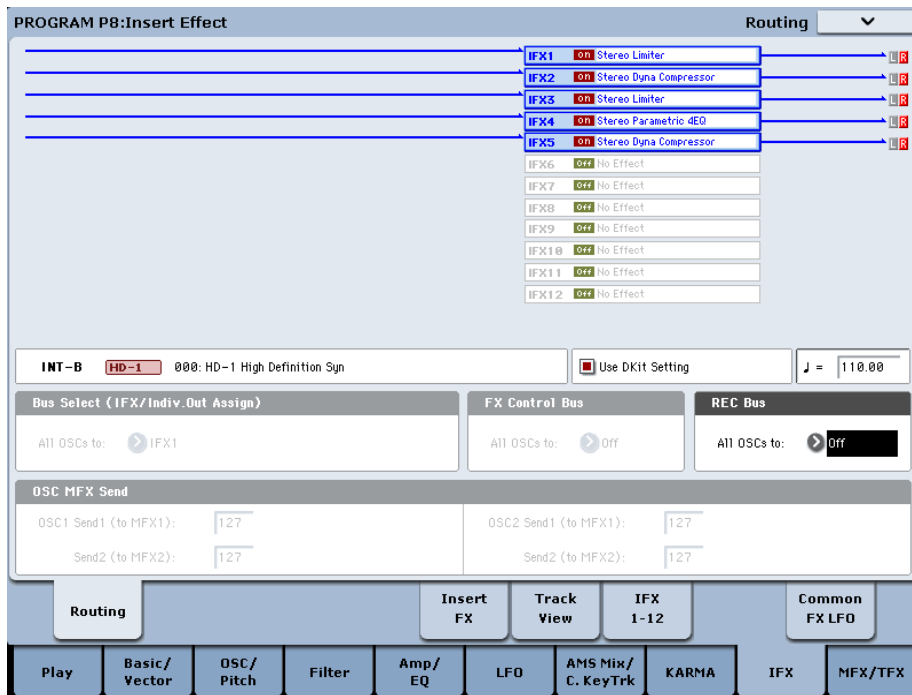

### 8-1c: Bus Select (IFX/Indiv.Out Assign)

**All OSCs to** [L/R, IFX1...12, 1...4, 1/2...3/4, Off]

This specifies the output bus for both oscillators 1 and 2.

**L/R:** The oscillators will go to the L/R bus. This is the default setting.

**IFX1...12:** The oscillators will go to the specified IFX bus.

**1...4:** The oscillators will be routed in mono to the specified AUDIO OUTPUT (INDIVIDUAL).

**1/2...3/4:** The oscillators will be routed in stereo, using the Pan setting (4-1c, 4-5: Amp/Driver2), to the specified AUDIO OUTPUT (INDIVIDUAL) pair.

**Off:** The oscillators will not go to any of the outputs directly. You can use this to route the sound completely through the MFX. Use **Send1 (to MFX1)** and **Send2 (to MFX2)** to specify the send levels.

### 8-1d: FX Control Bus

**All OSCs to** [Off, 1, 2]

Sends the output of oscillators 1 and 2 to an FX Control bus (two-channel stereo FX Ctrl 1 or 2).

Use the FX Control busses when you want a separate sound to control the audio input of an effect. You can use two FX Control busses (each is a two-channel stereo bus) to control effects in various ways.

For more information, please see "FX Control Buses" on page 860.

### 8-1e: REC Bus

**All OSCs to** [Off, 1...4, 1/2, 3/4]

These settings send the output of oscillators 1 and 2 to the REC busses (four mono channels: 1, 2, 3, 4).

The REC busses are dedicated internal busses for recording, used for sampling in the various modes or for recording audio tracks in Sequencer mode.

In Program mode, you can resample your keyboard or KARMA performance, or sample an external audio signal from the AUDIO INPUT jacks.

In order for you to sample, **Source Bus** must be set to a REC bus.

Normally you will set **Source Bus** to L/R so that you can sample the signal of the L/R bus line, such as your keyboard or KARMA performance. However, you can use a REC bus if you want to sample only an audio input while performing on the keyboard or KARMA function which are being output via L and R. If desired, multiple audio inputs can be mixed to a REC bus, or the direct signal from an audio input can be mixed to a REC bus along with the sound from an insert effect and sampled. For more information, see the diagram "Source Bus = REC Bus 1/2" on page 18.

**Off:** The signal will not be sent to a REC bus. This is the default.

**1...4:** The oscillators will be sent to the specified REC bus, in mono. The **Pan** settings (4-1c, 4-5: Amp/Driver2) will be ignored.

**1/2, 3/4:** The oscillators will be sent in stereo to the selected pair of REC busses.

---

## 8–1f: OSC MFX Send

### OSC1 Send1 (to MFX1) [000...127]

Sets the volume (send level) at which the output of oscillator 1 will be sent to master effect 1. This applies only when **Bus Select** (8–1c) is set to **L/R** or **Off**.

If **Bus Select** is set to **IFX1–IFX12**, the send levels to master effects 1 and 2 are set by **Send 1** and **Send 2** (8–5a) after passing through IFX1–12.

### OSC1 Send2 (to MFX2) [000...127]

Sets the volume (send level) at which the output of oscillator 1 will be sent to master effect 2 (see “OSC1 Send1 (to MFX1)”).

### OSC2 Send1 (to MFX1) [000...127]

### OSC2 Send2 (to MFX2) [000...127]

Sets the volume (send level) at which the output of OSC2 will be sent to master effects 1 and 2. These parameters will be valid when **Oscillator Mode** is set to **Double** and **Bus Select** is set to **L/R** or **Off**.

*Note:* You can use the control surface to control Send1 and Send2. These can also be controlled from the mixer section of the front panel, or from the P0– Control Surface page of the LCD screen. Here’s the procedure for editing these settings from the front panel.

1. Press the **CONTROL ASSIGN MIXER TIMBRE/TRACK** switch to turn it on (lit).
2. Press the **MIXER KNOBS** switch to select **CHANNEL STRIP**.
3. Use the **MIXER SELECT 1–2** switches to select the oscillator whose send levels you want to adjust.
4. Use **FX SEND 1 (knob 7)** and **FX SEND 2 (knob 8)** to control the send levels.

If **Bus Select (IFX/Indiv. Out Assign)** is set to **L/R** or **OFF**, this will control **OSC1 Send1 (to MFX1)** and **OSC2 Send2 (to MFX2)**.

If “**Bus Select (IFX/Indiv. Out Assign)** is set to **IFX1–12**, this will control **Send1** and **Send2** (P8– Insert FX page).

**MIDI** CC#93 scales OSC 1/2’s Send 1 level, and CC#91 scales the Send 2 level. These are controlled on the global **MIDI Channel** (Global 1–1a). The actual send level is determined by multiplying these values with the send levels of each oscillator.

---

## ▼ 8–1: Page Menu Commands

The number before each command shows its **ENTER + number-key** shortcut. For more information on these shortcuts, see “**ENTER + 0–9: shortcuts for menu commands**” on page 147.

- 0: **Write Program**. For more information, see “**Write Program**” on page 147.
- 1: **Exclusive Solo**. For more information, see “**Exclusive Solo**” on page 147.
- 2: **Copy Insert Effect**. For more information, see “**Copy Insert Effect**” on page 159.
- 3: **Swap Insert Effects**. For more information, see “**Swap Insert Effect**” on page 159.

## 8-5: Insert FX

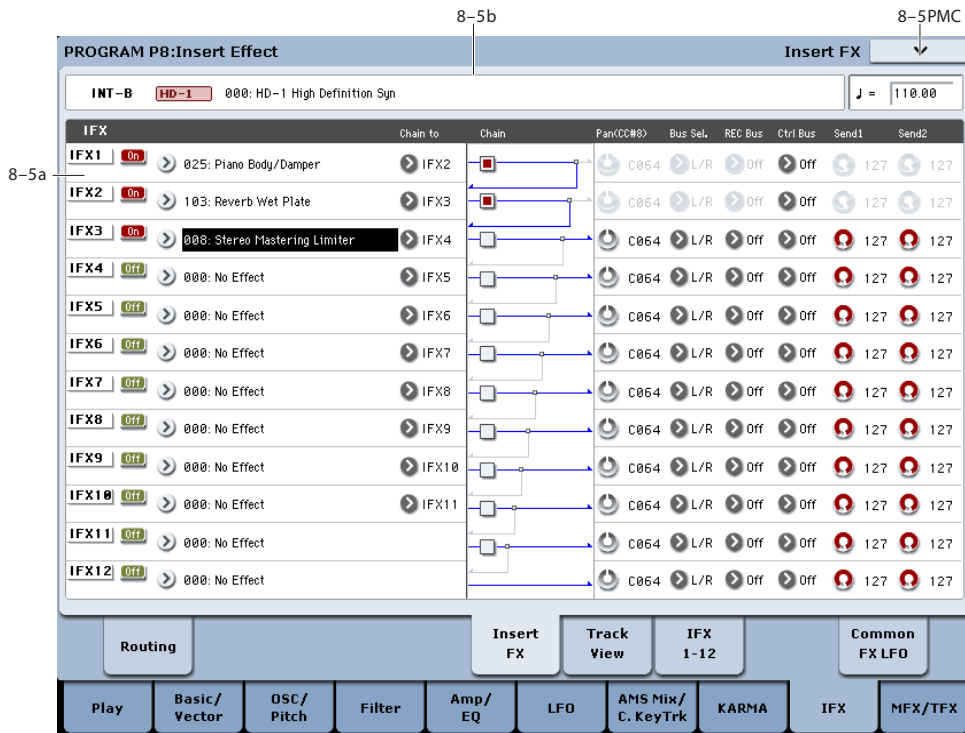

### 8-5a: IFX

Here you can choose effects for each of the 12 inserts, turn them on and off, configure chaining, and adjust the post-IFX mixer settings. For insert effects, the direct sound (Dry) is always stereo-in and out. The input/output configuration of the effect sound (Wet) depends on the effect type. For more information, please see “Insert Effects (IFX1...IFX12)” on page 864.

#### IFX1

**IFX1** [000...185]

This selects the effect type for insert effect 1.

#### Category/IFX Select menu

When you press the popup button, the Category/IFX Select menu will appear, letting you select effects by category.

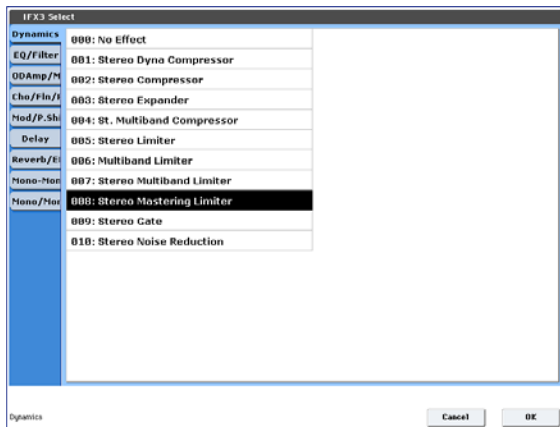

Use the tabs to select a category, and then select an effect within that category. Press the OK button to execute your selection, or press the Cancel button to cancel.

#### IFX1 On/Off [Off, On]

Switches the insert effect on/off. The setting will alternate between on and off each time you press the button.



If this is off, the input will simply be passed to the output. (When 000:No Effect is selected, there’s no audible difference between On and Off.) Note, however, that even when this is set to Off, the effect will continue to use processing power.

**MIDI** Separately from this setting, you can use MIDI CC #92 (on the global **MIDI Channel**) to turn all insert effects off. A value of 0 turns them off, and values of 1–127 restore the original setting.

#### Chain to [IFX2...IFX12]

You can chain up to twelve insert effects together in series, to create more complex effects. Set up the chain using this parameter, and then enable it using the **Chain** check box, below.

Effects must be chained in ascending numeric order. For example, IFX1 can be chained to any of IFX2 through IFX12, and IFX2 can be chained to IFX3 through IFX12.

You can chain two or more effects into the same downstream effect. For instance, both IFX1 and IFX2 can be chained to IFX6.

Effects can also join a chain in the middle. For instance, you can chain IFX3 to IFX4 to IFX9, and then chain IFX2 to IFX9 as well.

The **Pan (CC#8)**, **Bus Select**, **REC Bus**, and **Send1/2** settings apply only to the last effect in the chain. However, any effect in the chain can be sent to the FX Control buses.

**Chain** [Off, On]

This enables the chain, as set up by the **Chain to** parameter, above.

**Pan (CC#8) (Post IFX Pan)** [L000...C064...R127]

Specifies the panning immediately after the insert effect.

 You can use CC#8 to control this.

**Bus Sel. (Bus Select)** [L/R, 1...4, 1/2...3/4, Off]

Specifies the bus to which the signal will be sent immediately after the insert effect.

**L/R:** The signal will be sent to the L/R bus, which passes through TFX 1 and 2 and then goes to the main L/R outputs. This is the default setting.

**1...4:** The signal will be sent, in mono, to the selected individual output.

**1/2, 3/4:** The signal will be panned by the **Pan (CC#8)** setting, and sent in stereo to the selected pair of audio outputs.

**Off:** The signal will not be sent directly to the outputs. This setting is useful if you want to:

- Use **Send 1** or **2** to route the signal entirely through the master effects, without sending the dry signal to the outputs.
- Use the **FX Control Bus** to route the signal to an effects side-chain, such as a gate or vocoder, without being heard directly at the outputs.
- Use the **REC Bus** to record the signal, without routing the signal directly to the outputs.

**FX Control Bus** [Off, 1, 2]

This sends the post-IFX signal to the FX Control busses. For more information, see “8–1d: FX Control Bus” on page 135.

**REC Bus** [Off, 1, 2, 3, 4, 1/2, 3/4]

Sends the post-IFX signal to the REC busses. For more information, see “8–1e: REC Bus” on page 135. If you want to resample via the REC busses, set the sampling **Source Bus** (0–8d) to REC 1/2 or REC 3/4.

**Send1** [000...127]

**Send2** [000...127]

These adjust the level at which the post-IFX signal is sent to master effects 1 and 2. This is valid if **Bus Select** (8–5a) is set to L/R or Off.

*Note:* You can use the control surface to control Send1 and Send2. (See “8–1f: OSC MFX Send” on page 136)

 You can use CC#93 to control the Send 1 level, and CC#91 to control the Send 2 level. The global MIDI channel specified by **MIDI Channel** (Global 1–1a) is used for these messages.

**IFX2... 12**

Here you can specify each insert effect’s effect type, on/off status, chaining, and mixer settings following the insert effect. With the exception of **Chain to** and **Chain**, the parameters are the same as for IFX1. See “IFX1” on page 137.

**IFX2: Chain to** [IFX3...IFX12]

**IFX3: Chain to** [IFX4...IFX12]

**IFX4: Chain to** [IFX5...IFX12]

**IFX5: Chain to** [IFX6...IFX12]

**IFX6: Chain to** [IFX7...IFX12]

**IFX7: Chain to** [IFX8...IFX12]

**IFX8: Chain to** [IFX9...IFX12]

**IFX9: Chain to** [IFX10...IFX12]

**IFX10: Chain to** [IFX11...IFX12]

**IFX11: Chain to** [(IFX12)]

These specify the chain destination for each insert effect. If **Chain** is enabled, the insert effect will be connected in series to the IFX specified by the **Chain to** setting.

**Chain** [Off, On]

Specifies whether insert effects will be connected in series.

If the **Chain** check box is on, this insert effect will be connected in series to the insert effect selected by “Chain to.” This is not available for IFX12.

*Tip:* If you move from this page to the P8– IFX1–12 page, the IFX you choose here will be selected.

▼ **8–5: Page Menu Commands**

The number before each command shows its ENTER + number-key shortcut. For more information on these shortcuts, see “ENTER + 0-9: shortcuts for menu commands” on page 147.

- **0: Write Program.** For more information, see “Write Program” on page 147.
- **1: Exclusive Solo.** For more information, see “Exclusive Solo” on page 147.
- **2: Copy Insert Effect.** For more information, see “Copy Insert Effect” on page 159.
- **3: Swap Insert Effects.** For more information, see “Swap Insert Effect” on page 159.
- **4: Insert IFX Slot.** For more information, see “Insert IFX Slot” on page 160.
- **5: Cut IFX Slot.** For more information, see “Cut IFX Slot” on page 161.
- **6: Clean Up IFX Routings.** For more information, see “Clean Up IFX Routings” on page 162.

## 8-6: Track View

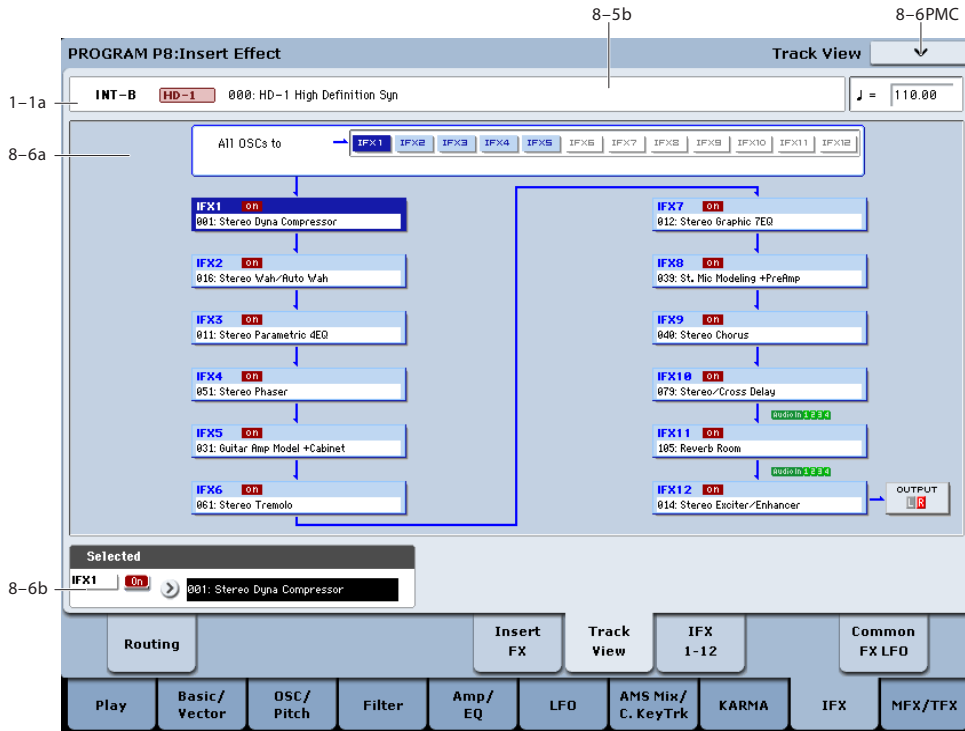

### 8-6a: Track View

This shows the oscillator 1, 2 output and insert effect routing.

The selected slot is shown in dark blue. In the “Selected” area below, you can specify the “Effect Type” and “On/Off” status. The “Insert IFX Slot” and “Cut IFX Slot” page menu commands will apply to the slot you select here.

If you move from this page to the P8-IFX1-12 page, the IFX you choose here will be selected.

In the following diagram, the “Audio In” shown below IFX10 and IFX11 indicates the insert effects through which Audio Input 1-2 and S/P DIF L/R are passing.

In this example, you can see that Audio Input 1-2 and S/P DIF L/R are passing through IFX11 and IFX12.

“OUTPUT” shows the Bus Select setting that follows the insert effects. This tells you where the audio signal is being output.

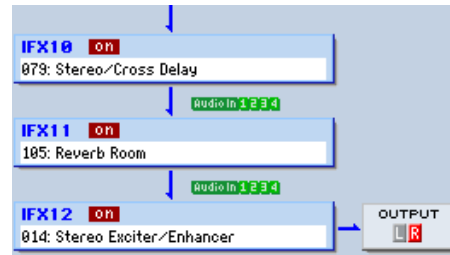

The following diagram shows the IFX assigned to each key of a drum kit when **Oscillator Mode** is set to Drums for an HD-1 Program and Use DKit Setting is turned on.

In this example, you can see that IFX1, 2, 3, 4, and 5 are each used by a key in the drum kit (shown in light blue). If you press an IFX that is being used, that effect will be shown in the line below.



### 8-6b: Selected

Here you can specify the “Effect Type” and “On/Off” status of the insert effect slot selected by Track Select. (“8-6a: Track View,” above)

### ▼ 8-6: Page Menu Commands

The number before each command shows its ENTER + number-key shortcut. For more information on these shortcuts, see “ENTER + 0-9: shortcuts for menu commands” on page 147.



- 0: **Write Program.** For more information, see “Write Program” on page 147.
- 1: **Exclusive Solo.** For more information, see “Exclusive Solo” on page 147.
- 2: **Copy Insert Effect.** For more information, see “Copy Insert Effect” on page 159.
- 3: **Swap Insert Effects.** For more information, see “Swap Insert Effect” on page 159.
- 4: **Insert IFX Slot.** For more information, see “Insert IFX Slot” on page 160.
- 5: **Cut IFX Slot.** For more information, see “Cut IFX Slot” on page 161.
- 6: **Clean Up IFX Routings.** For more information, see “Clean Up IFX Routings” on page 162.

## 8-7: IFX 1-12

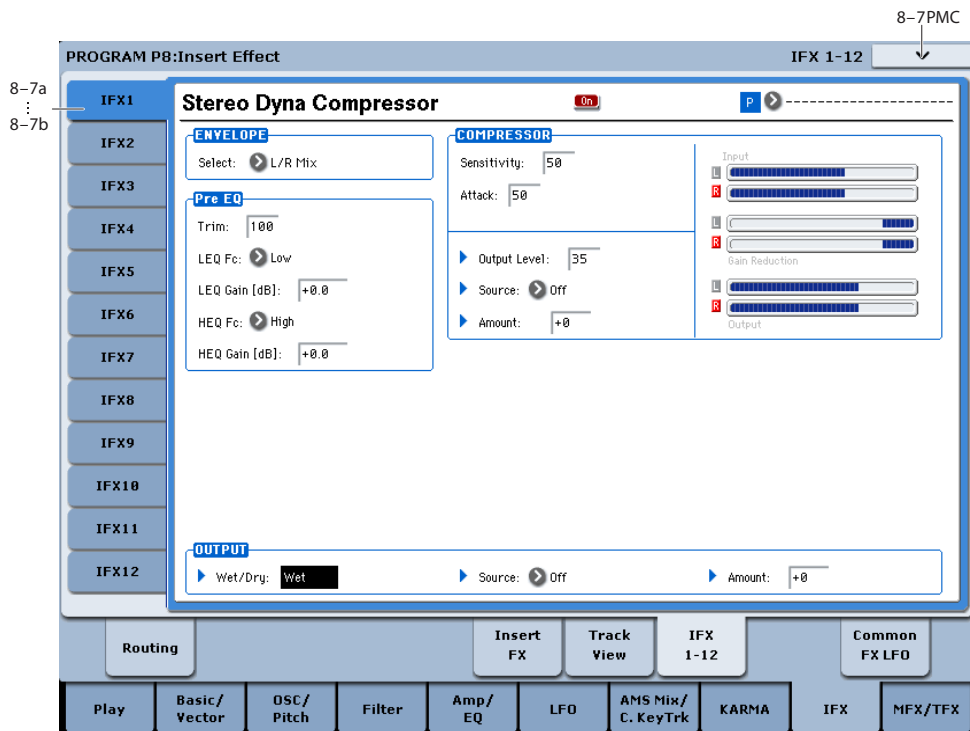

This page lets you edit the detailed parameters of the twelve insert effects. Use the tabs at left to select IFX1 through IFX12.

To select different effects types, use the Insert FX or Track View pages. For more information, see “8-5: Insert FX” on page 137 and “8-6: Track View” on page 139.

### Effects Modulation: Dmod

Most effects have one or more parameters which can be modulated in realtime. In the KRONOS, this is called Dynamic Modulation, or Dmod for short.

For a complete list of Dmod sources, see “Dynamic Modulation Source List” on page 1101.

**MIDI** Effect dynamic modulation (Dmod) is controlled on the global **MIDI Channel** (Global 1-1a). For more information, see “Dynamic modulation (Dmod) and Tempo Synchronization” on page 859.

### 8-7a: IFX1

Here you can edit the parameters of the insert effect you selected in the P8- Insert FX page. Use the tabs at the left to select IFX1-12.

### IFX1 On/Off [Off, On]

This turns the insert effect on and off. It is linked with the on/off setting in the Insert FX page.



### P (Effect Preset) [P00, P01...15, U00...15, -----]

Effect Presets let you easily store and recall all of the settings for an individual effect. You can store up to 16 user presets for each effect type, in addition to 15 re-writable factory presets.



The same presets appear in all of the modes (Program, Combi, Sequence, and Sampling), and sets of presets can be saved to and loaded from disk.

Note that edits to effects parameters are automatically stored with the Program—you don’t need to store them as an Effect Preset. Presets just make it easier to re-use your favorite settings.

For instance, you can save an Effect Preset while working on a particular Program, and then later use the same Effect Preset in a different Program, Combi, or Song.

**P00: Initial Set:** These are the default settings that are recalled when you select an effect type in the Insert FX page. You can’t save your own settings here.



**P01...P15:** These contain Korg preset data. We recommend that you store your settings in U00-U15.

**U00...U15:** These are areas in which you can store your own settings.

-----: This shows that no Effect Preset has been selected. You'll see this if you've just selected an effect, written a Program, or selected a new Program. Selecting this setting from the menu will not have any effect.

**Note:** Programs save the effects parameter settings, but they don't save the number of the selected Effect Preset. If you select an Effect Preset, and then save the Program, the Effect Preset setting will revert to "-----."

**Using Effect Presets**

1. Select an effect in the Insert FX page.
2. The P00: Initial Set settings will be recalled. "P (Effect Preset)" will show -----.
3. Use "P (Effect Preset)" to select an effect preset: P00-P15 or U00-U15. The stored parameters will be recalled. Note that this will overwrite all parameters of the effect.
4. Edit the recalled parameters as desired.
5. If you've come up with settings you like and want to save them as a new preset, use the Write FX Preset menu command.

**IFX1 Parameters**

This tab shows the parameters for IFX1, as selected on the P8: Insert FX page.

For details on the specific parameters of each effect, please see "Insert Effects (IFX1...IFX12)" on page 864.

**8-7b: IFX2...12**

These tabs show the parameters for IFX2-12, as selected on the P8: Insert FX page. They have the same controls as described under "8-7a: IFX1," above.

**▼ 8-7: Page Menu Commands**

The number before each command shows its ENTER + number-key shortcut. For more information on these shortcuts, see "ENTER + 0-9: shortcuts for menu commands" on page 147.

- 0: **Write Program.** For more information, see "Write Program" on page 147.
- 1: **Exclusive Solo.** For more information, see "Exclusive Solo" on page 147.
- 2: **Copy Insert Effect.** For more information, see "Copy Insert Effect" on page 159.
- 3: **Swap Insert Effects.** For more information, see "Swap Insert Effect" on page 159.
- 4: **Write FX Preset.** For more information, see "Write FX Preset" on page 163.

**8-9: Common FX LFO**

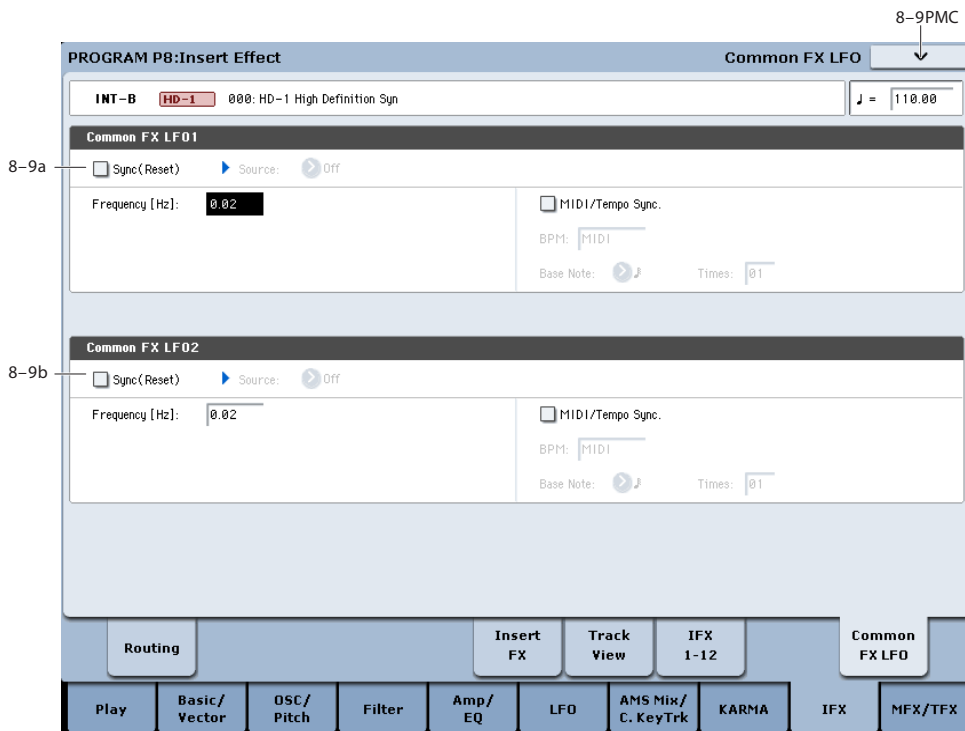

The two Common FX LFOs allow you to synchronize LFO-based modulation for multiple effects, such as phasers, flangers, filters, and so on.

The Common LFOs control only the frequency, MIDI synchronization, and reset options; each individual effect still has its own settings for the LFO waveform and phase.

Within the individual effects, you can choose whether to use one of the Common LFOs, or to use the individual effect's frequency, sync, and/or reset settings instead. This is done via the effect's **LFO Type** parameter; select **Individual** to use the effect's settings, or **Common 1** or **2** to use the Common LFOs.

**MIDI** Dmod (Dynamic Modulation) is controlled on the global MIDI channel specified in Global mode P1.

### 8-9a: Common FX LFO1

**Sync (Reset)** [Off, On]

This specifies whether the Common FX LFO will be reset.

If this is on, operating the **Source** (below) will reset the phase of the LFO.

**Source (Dmod Source)** [List of Dmod Sources]

If "Sync (Reset)" is on, this selects the Dmod source that will reset the Common LFO. For a complete list of Dmod sources, see "Dynamic Modulation Source List" on page 1101.

**MIDI** This will be off when the modulation source specified by **Source** has a value below 64, and on when the value is above 64. The LFO will be reset when this value rises from a level below 64 to a level higher than 64.

**Frequency** [0.02...20.00 Hz]

This specifies the frequency of the Common FX LFO. Higher values make the LFO faster.

**MIDI/Tempo Sync** [Off, On]

**On (checked):** The LFO will synchronize to the system tempo, as set by either the Tempo knob or MIDI Clock. The LFO speed will be controlled by the **Base Note** and **Times** parameters, below. All settings for **Frequency** and **Frequency Modulation** will be ignored.

**Off (unchecked):** The Frequency settings will determine the speed of the LFO, and the tempo settings will have no effect.

**BPM** [MIDI, 40.00...300.00]

**Base Note** [♪...♩]

This sets a basic rhythmic value for the LFO speed, relative to the system tempo. The values range from a 32nd note to a whole note, including triplets. It applies only when **MIDI/Tempo Sync** is **On**.

**Times** [01...32]

This multiplies the length of the **Base Note**. For instance, if the **Base Note** is set to a sixteenth note, and Times is set to 3, the LFO will cycle over a dotted eighth note.

### 8-9b: Common FX LFO2

The parameters are identical to those for Common FX LFO1, as described under "8-9a: Common FX LFO1" on page 142.

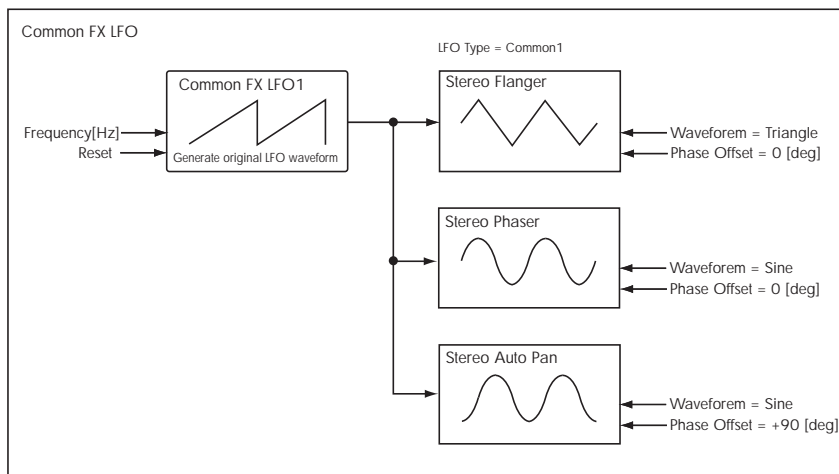

### ▼ 8-9: Page Menu Commands

The number before each command shows its ENTER + number-key shortcut. For more information on these shortcuts, see "ENTER + 0-9: shortcuts for menu commands" on page 147.

- 0: **Write Program**. For more information, see "Write Program" on page 147.
- 1: **Exclusive Solo**. For more information, see "Exclusive Solo" on page 147.
- 2: **Copy Insert Effect**. For more information, see "Copy Insert Effect" on page 159.

- 3: **Swap Insert Effects**. For more information, see "Swap Insert Effect" on page 159.

## Program P9: Master/Total Effect

Here you can make settings for the master effects and total effects. For instance, you can:

- Route a sound to an master effects and total effects

- Make detailed settings for master effects and total effects

For more information, please see “Effect Guide” on page 857.

## 9-1: Routing

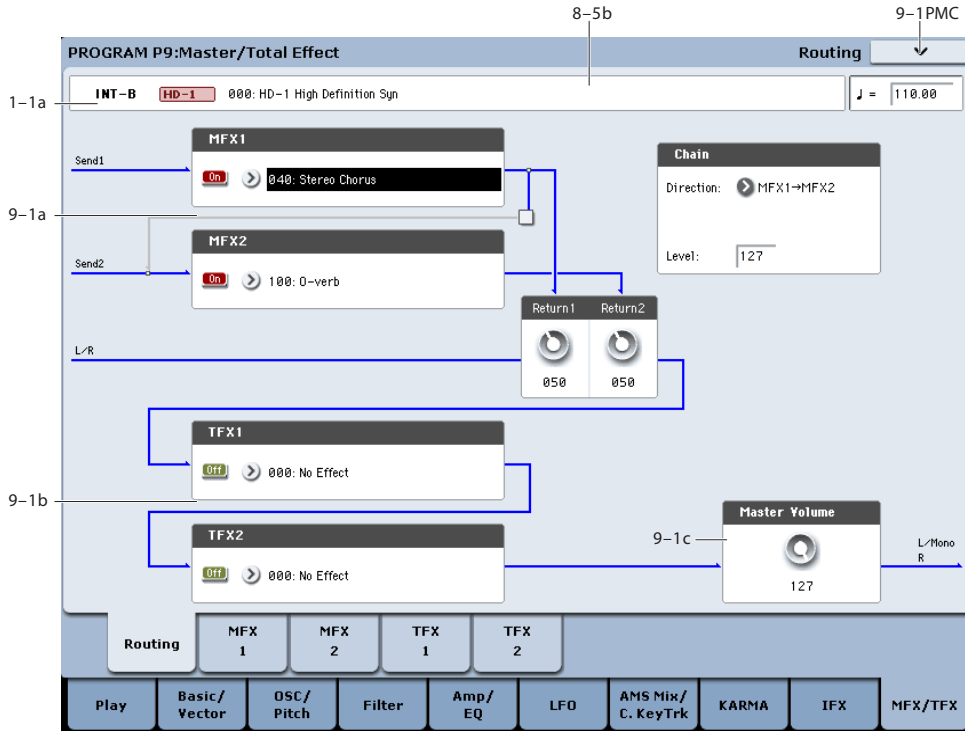

Here you can specify the type of master effects and total effects, and turn them on/off.

The master effects are sent to the L/R bus. The total effects are inserted into the L/R bus.

### 9-1a: MFX1, 2

The master effect does not output the direct sound (Dry). Adjust the “Return 1” and “Return 2” return levels to return the signal to the L/R bus and mix it with the L/R bus signal.

The master effects are stereo-in/out, but depending on the selected effect type, the output may be monaural. See “In/Out” on page 864.

#### MFX1

#### MFX1 [000...185]

This selects the effect type for master effect 1. You can use any of the available effects, without limitation. If you choose 000:No Effect, the output from the master effect is muted.

#### Category/MFX Select menu

When you press the popup button, the Category/MFX Select menu will appear, letting you select effects by category. Use the tabs to select a category, and then

select an effect within that category. Press the OK button to execute your selection, or press the Cancel button to cancel.

#### MFX1 On/Off

[Off, On]

Switches the master effect 1 on/off. When off, the output will be muted. This will alternate between on and off each time it is pressed.



Separately from the settings here, you can use control change #94 to turn master effects 1 and 2 off. A value of 0 turns them off, and values of 1-127 restore the original setting. The global MIDI channel specified by MIDI Channel (Global 1-1a) is used for this message.

#### Return 1

[000...127]

This specifies the return level from the master effect to the L/R bus (after which it passes through TFX1 and 2, and is sent from L/MONO and R).

#### MFX2

#### MFX2

[000...185]

#### MFX2 On/Off

[Off, On]

#### Return 2

[000...127]

These parameters specify the effect type for master effect 2, its on/off status, and the return level from master effect 2 to the L/R bus. See “MFX1” on page 143.

Category/MFX Select menu

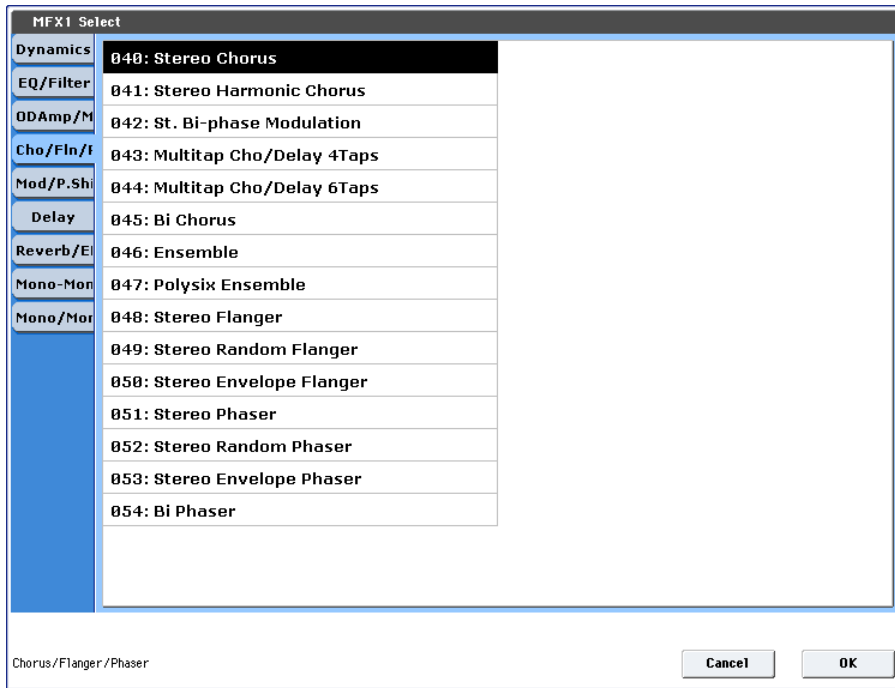

**Chain:**

**Chain On/Off** [Off, On]

**On (checked):** Chain (series connection) will be turned on for MFX1 and MFX2.

**Chain Direction** [MFX1->MFX2, MFX2->MFX1]

Specifies the direction of the connection when MFX1 and MFX2 are chained.

**MFX1->MFX2:** Connect from MFX1 to MFX2.

**MFX2->MFX1:** Connect from MFX2 to MFX1.

**Chain Level** [000...127]

When chain is On, this sets the level at which the sound is sent from the first master effect to the next master effect.

**9-1b: TFX1, 2**

These are the parameters for total effect 1 and 2, which are placed at the final stage of the L/R bus. After passing through the total effects, the sound is output to AUDIO OUTPUT (MAIN OUT) L/MONO and R.

For the total effects, the direct sound (Dry) is always stereo-in/out. The input/output configuration of the effect sound (Wet) will depend on the selected effect type.

The total effects are stereo-in and stereo-out, but the output may be monaural depending on the type of effect you select. (See "In/Out" on page 864.)

**TFX1**

**TFX1** [000...185]

This selects the effect type for total effect 1. You can use any of the available effects, without limitation.

**Category/TFX Select menu**

When you press the popup button, the Category/TFX Select menu will appear, letting you choose effect types by category. Use the tabs to select an effect category, and then choose an effect within that category. Press the OK button to execute your choice, or press the Cancel button to cancel.

**TFX1 On/Off** [Off, On]

This turns total effect 1 on/off. If this is off, the input will be passed directly through. The setting will alternate between on/off each time you press this.



**MIDI** Separately from this setting, you can use control change #95 to turn both total effects off. A value of 0 turns them off, and values of 1-127 restore the original setting. The global MIDI channel specified by **MIDI Channel** (Global 1-1a) is used for this message.

**TFX2**

**TFX2** [000...185]

**TFX2 On/Off** [Off, On]

These parameters specify the effect type and on/off status for total effect 2. See "TFX1" on page 144.

**9-1c: Master Volume**

**Master Volume** [000...127]

This specifies the final level of the audio output that has passed through total effects 1 and 2, and output from AUDIO OUTPUT (MAIN OUT) L/MONO and R.

*Note:* You can control the master volume from the control surface. You can also control this setting from the P0- Control Surface page.

1. Press the CONTROL ASSIGN MIXER TIMBRE/TRACK, MIXER AUDIO or R.TIME KNOBS/KARMA switch to turn it on (lit).
2. Use the MIX VOLUMES MASTER slider to control the level.

- 0: Write Program. For more information, see "Write Program" on page 147.
- 1: Exclusive Solo. For more information, see "Exclusive Solo" on page 147.
- 2: Copy MFX/TFX. For more information, see "Copy MFX/TFX" on page 162.
- 3: Swap MFX/TFX. For more information, see "Swap MFX/TFX" on page 163.

### ▼ 9-1: Page Menu Commands

The number before each command shows its ENTER + number-key shortcut. For more information on these shortcuts, see "ENTER + 0-9: shortcuts for menu commands" on page 147.

## 9-2: MFX1

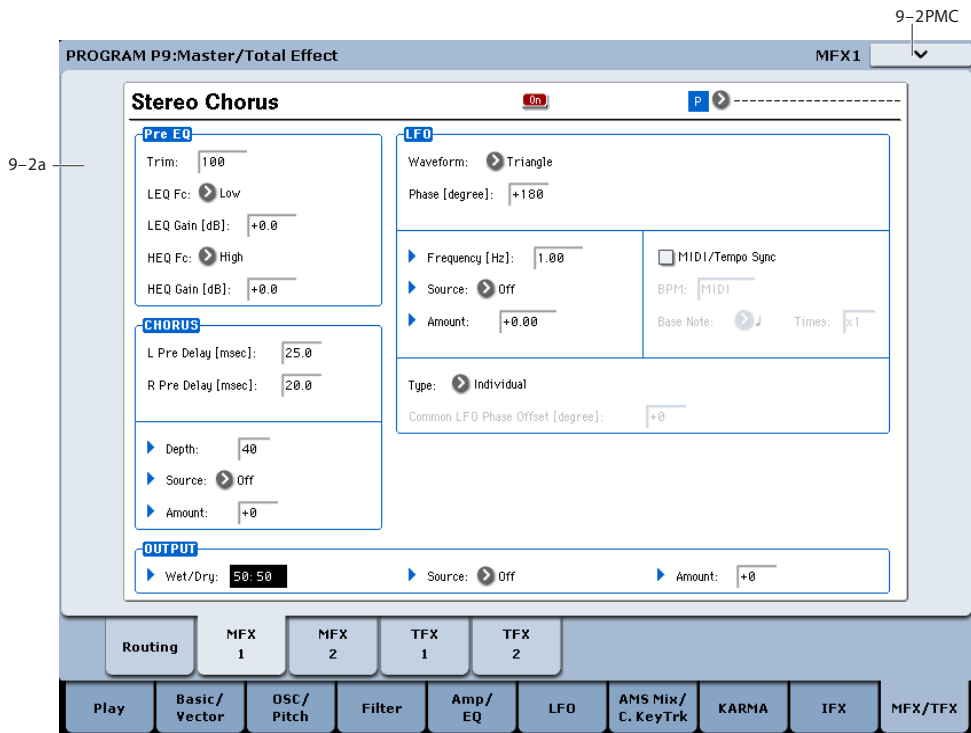

### Effects Modulation: Dmod

Most effects have one or more parameters which can be modulated in realtime. In the KRONOS, this is called Dynamic Modulation, or Dmod for short.

For a complete list of Dmod sources, see "Dynamic Modulation Source List" on page 1101.

**MIDI** Effect dynamic modulation (Dmod) is controlled on the global **MIDI Channel** (Global 1-1a). For more information, see "Dynamic modulation (Dmod) and Tempo Synchronization" on page 859.

### 9-2a: MFX1

Here you can edit the parameters of the effect you choose for MFX1 in the P9- Routing page.

**MFX1 On/Off** **[Off, On]**



This turns master effect 1 on/off. It is linked with the on/off setting in the P9- Routing page.

**P (Effect Preset)** **[P00, P01...15, U00...15, -----]**



This selects the effect preset. For more information, please see "P (Effect Preset)" on page 140.

#### MFX1 Parameters

Here you can edit the parameters of the master effect selected in the P9- Routing page.

For more information on using the master effects, please see “Master Effects (MFX1, 2)” on page 877.

---

### ▼ 9–2: Page Menu Commands

The number before each command shows its ENTER + number-key shortcut. For more information on these shortcuts, see “ENTER + 0-9: shortcuts for menu commands” on page 147.

- **0: Write Program.** For more information, see “Write Program” on page 147.
  - **1: Exclusive Solo.** For more information, see “Exclusive Solo” on page 147.
  - **2: Copy MFX/TFX.** For more information, see “Copy MFX/TFX” on page 162.
  - **3: Swap MFX/TFX.** For more information, see “Swap MFX/TFX” on page 163.
  - **4: Write FX Preset.** For more information, see “Write FX Preset” on page 163.
- 

### 9–3: MFX2

---

### 9–4: TFX1

---

### 9–5: TFX2

These pages let you edit the parameters of Master Effect 2 and Total Effects 1 and 2. To select different effects types, use the Routing page, as described under “9–1: Routing” on page 143.

The parameters for MFX2, TFX1, and TFX2 are the same as for MFX1. For more information, see “9–2: MFX1” on page 145.

## Program: Page Menu Commands

### ENTER + 0-9: shortcuts for menu commands

Each page has a set of menu commands, which provide access to different utilities, commands, and options, depending on the page you're currently on. You can use the menu commands entirely from the touch-screen, by pressing the menu button in the upper right-hand corner of the screen and then selecting an option from the menu that appears.

Even though each page may have its own unique menu commands, the menus are standardized as much as possible. For instance, WRITE is almost always the first menu item in Program, Combination, and Sequence modes.

You can take advantage of this standardization by using a shortcut to access any of the first ten menu items:

1. Hold down the ENTER key.
2. Press a number (0-9) on the numeric keypad to select the desired menu command, starting with 0.

For instance, press 0 for the first menu command, 1 for the second, and so on.

If the menu command just toggles an option on and off (such as Exclusive Solo), then you're done. If the command calls up a dialog box, the dialog will appear on the LCD, and you can proceed just as if you'd selected the command from the touch-screen.

### Write Program

This command writes an edited Program into the KRONOS internal memory. It is available on every page in Program mode.

Write Program lets you:

- Save your edits
- Rename the Program
- Assign the Program to a Category
- Mark the Program as a Favorite
- Copy the Program to a different Bank and number

 Be sure to **Write** any Program that you wish to keep. An edited Program cannot be recovered if you do not write it before turning off the power or selecting another Program.

1. Select "Write Program" to open the dialog box.

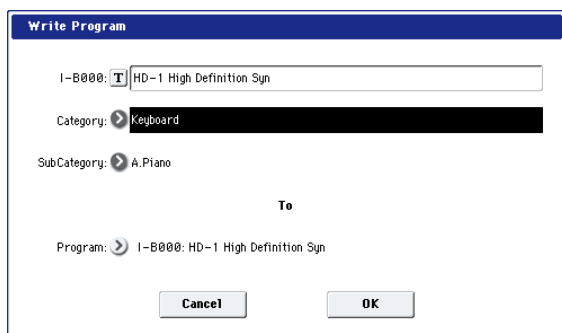

The upper line of the dialog shows the Bank, number, and Program name.

If you wish to modify the Program name, press the text edit button to move to the text edit dialog box, and enter the desired program name.

2. In Category and Sub Category, specify the category of the program that you are writing.

The category can be used to find this Program when selecting a program in Program, Combination, or Sequencer modes.

*Note:* You can edit these category names in the Global Program Category page. For more information, see "3-1: Program Category" on page 785.

3. Press "To Program" to specify the destination Bank and number.

You can also use the BANK INT A-USER G switches to select a bank.

 **Important:** HD-1 Programs can only be written to HD-1 Banks, and EXi Programs can only be written to EXi Banks. For more information on the default Bank types, and on how to change them, please see "Program Bank Contents" on page 3, and "Changing the Bank Type for USER Banks" on page 3.

4. To Write the Program, press the OK button. To cancel, press the Cancel button.

 Do not turn off the power for at least 10 seconds after using the **Write Program** command. This allows the system time to complete the process, which includes saving a backup of the data to the internal disk.

### Saving edits to GM Programs

You can edit GM Programs, but you must then save them to a Bank other than INT-G; the GM Programs themselves cannot be over-written.

### Shortcut: SEQUENCER REC/WRITE

You can also use the SEQUENCER REC/WRITE button to quickly update the current Program, using the existing name, bank, number, and category. To do so:

1. Press the SEQUENCER REC/WRITE button.

The Update Program dialog will appear.

2. Press OK to write the program.

### Exclusive Solo

This command is available on every page in Program mode.

The menu's **Exclusive Solo** parameter affects the way that Solo works. When **Exclusive Solo** is **Off** (unchecked), you can solo multiple Tracks and inputs at once.

When **Exclusive Solo** is **On** (checked), only one MIDI Track, HDR Track, or Audio Input can be soloed at a time. In this mode, pressing a Solo switch automatically disables any previous solos.



On most pages, you can also toggle **Exclusive Solo** by holding ENTER and pressing 1 on the numeric keypad.

For more information on Solo, please see:

- Program mode: “Solo” on page 24
- Combination mode: “Solo” on page 430
- Sequence mode: “Solo” on page 536

---

## Show MS/WS/DKit Graphics

This works in conjunction with the P1 Program Basic page’s **Play Page MS/WS/DKit Display** parameters to control whether the main P0 Play page shows the overview/jump parameters, or the selected graphics.

It only applies if a graphic has been selected for **Play Page MS/WS/DKit Display Osc 1** or **Osc 2**. If these parameters are instead set to Show MS/WS/DK Names, the menu command has no effect. For more information, see “1–1h: Play Page MS/WS/DKit Display” on page 41.

This mirrors the Global parameter “Show MS/WS/DKit Graphics” on page 758. Changes to the menu are reflected in the Global parameter, and vice-versa. To save this setting, use the Write Global Setting command in Global mode.

---

## Add To Set List

This command, available on the P0 pages of Program, Combination, and Sequencer modes, allows the addition of the current item to the current Set List.

When you select this command, the current Program, Combination, or Song is inserted at the current Slot, using the same logic as the Set List Edit page’s Insert command.

The name of the Program, Combination, or Song is copied into the slot name. You can change this later if desired.

---

## Auto Assign KARMA RTC Name

This command is available on the KARMA GE tab of the Play page, and the Name/Note Map tab of the KARMA page.

**Auto Assign KARMA RTC Name** will automatically assign appropriate names to the KARMA Sliders and Switches, based on the GE Real-Time parameters and Performance Real-Time parameters to which they are assigned. You can use this when creating new KARMA function assignments, or editing existing ones.

The names are selected from a list of 400 options, such as Rhythm Swing% and Rhythm Complexity.

1. Choose “Auto Assign KARMA RTC Name” to open the dialog box.
2. To execute the command, press the OK button. To cancel without executing, press the Cancel button.

⚠ Please be aware that even with un-edited, factory-preloaded Programs or Combinations, executing this command may assign names that are different from those currently specified.

---

## Copy Note Map

This command copies settings from a preset table or from the custom note map of a specified program, combination, or song to the currently selected custom note map.

1. Choose “Copy Note Map” to open the dialog box.

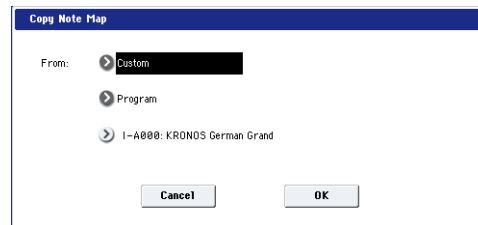

2. Use the “From” field to specify the copy-source note map table.

Choose Custom if you want to copy from the custom note map used by a desired program, combination, or song.

Choose the desired table if you want to copy from a preset table.

Note: By default, the “Table” setting is selected in the Copy Note Map “From” field. If you want to copy a preset table, it’s a good idea to verify and select the table that you want to copy to the custom note map before you choose this command.

3. If you’ve specified Custom, select the copy-source mode, bank, and number. You can also select the bank by pressing the BANK SELECT [I-A]...[U-G] switches.
4. Press the OK button to execute the Copy Note Map command, or press the Cancel button if you decide not to execute.

When you press the OK button, the selected table will be copied to the custom note map.

---

## Optimize RAM

**Optimize RAM** is available on the Audio In/Sampling tab of the Play page.

In some cases, especially if you’ve been loading and deleting different Samples and Multisamples, the internal memory can become fragmented.

“Fragmented” means that there are chunks of data scattered throughout the physical RAM, like toy blocks scattered across a floor. While the memory isn’t completely full, some of it can’t be used - just like it’s difficult to walk across a messy floor.

The **Optimize RAM** command cleans up the floor, so to speak. It collects all of the data into a single, continuous area of memory, so that the remaining free space can be used more efficiently.

If you run out of memory, try using this command; it may free up some extra space.

You can check the remaining amount of RAM in Sampling mode, on the main Recording page, under “Free Sample Memory/Locations.” For more information, please see “RAM” on page 684.

1. Select "Optimize RAM" to open the dialog box.



2. Press the OK button to execute the command, or press the Cancel button to cancel without executing.

### Auto Optimize RAM

If **Auto Optimize RAM** (Global 0-1d) is enabled, you don't need to use the **Optimize RAM** command; instead, RAM will be optimized automatically.

---

## Select Sample No.

**Select Sample No.** is available on the Audio In/Sampling tab of the Play page, when the sampling **Save To** parameter is set to RAM.

This specifies the sample number into which the sampled data will be written. You can also specify whether the sample will automatically be converted to a program after sampling.

1. Choose **Select Sample No.** to open the dialog box.

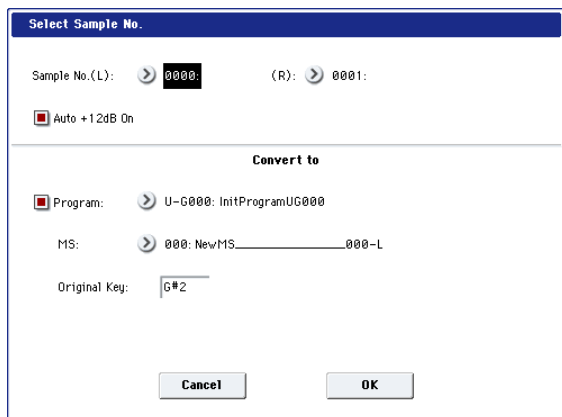

2. In "Sample No.," specify the writing-destination sample number.

By default, this will be the lowest-numbered vacant sample number. If you select "----:----No Assign----" or a sample number that already contains data, the data will automatically be sampled into the lowest vacant sample number. If you are sampling in stereo, "Mode" (0-8c), specify "Sample No.(L)" and "Sample No.(R)."

3. Set **Auto +12dB On**.

**On (checked): +12dB** will automatically be enabled for newly recorded samples. This is the default setting, and if **Recording Level** is set to 0.00 (dB), it means that resampled sounds will play back at the same volume as when they were recorded.

Note that **+12dB** does not change the sample data itself; it only affects the way that the sample is played back.

In general, **+12dB** should be On for drums and loops, and Off for any sounds that you play polyphonically. For more information, see "+12dB" on page 701.

The **Auto +12dB On** setting is made independently for Program, Combination, Sequencer, and Sampling modes.

4. "Convert to" specifies whether the sample will automatically be converted into a program as soon as it has been sampled. This is convenient when you want to hear the sound immediately after sampling.

If you check the **Program** check box, the sample will automatically be converted into a program.

At the right, set **Program** and **MS** to specify the program number and multisample number for the converted program.

Set **Original Key** (Sampling 0-1b) to specify the location of the original key. The multisample will create an **Index** (Sampling 0-1b) with this key as the **Top Key** (Sampling 0-1b). The **Original Key** will increment by one after sampling, and the next higher note will be assigned the next time you sample.

5. Press the OK button to apply the settings you made, or press the Cancel button to return to the state prior to accessing this dialog box.

---

## Select Directory

**Select Directory** is available on the Audio In/Sampling tab of the Play page, when the sampling **Save To** parameter is set to DISK.

When sampling to disk, this lets you set the disk, directory, and file name for the resulting WAVE file.

This dialog also lets you audition WAVE files directly from the disk; you can use this as a shortcut, instead of using the similar function in DISK mode.

### Specifying the save destination for a WAVE file

1. Select the **Select Directory** command to open the dialog box.
2. Use the popup button located at the left of Drive select to select the writing-destination drive for sampling.
3. Use the Open and Up buttons to move to the desired directory.
4. In **Name**, specify a name for the WAVE file that will be written during sampling.

If you check **Take No.**, the file will be saved with a two-digit **Take No.** added to the end of the filename. This number will automatically increment each time you sample. This is convenient when you are sampling repeatedly, since each sample will be saved with its own filename.

5. Press the Done button to complete the settings.

### Playing back a WAVE file

1. Select the **Select Directory** command to open the dialog box.
2. Use Drive Select and the Open and Up buttons to select the drive and directory, and select the WAVE file (48 kHz) that you want to play.
3. Press the SAMPLING START/STOP switch or Play button.

The selected WAVE file will be played.

Select Directory

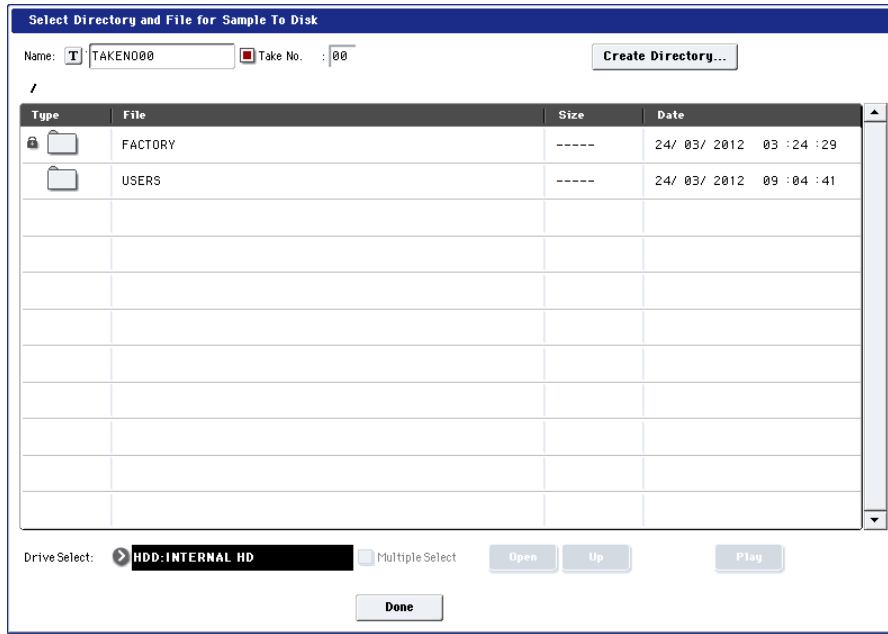

4. Press the SAMPLING START/STOP switch or Stop button once again to stop playback.

If the WAVE file is mono, the same sound will be output to L/R.

### Auto Sampling Setup

Auto Sampling Setup is available on the Audio In/Sampling tab of the Play page.

This command automatically configures the Program mode sampling-related parameters, making it easy for you to sample an external audio source or to resample your performance as you play a Program. You can also use this command to initialize the sampling settings.

After using Auto Sampling Setup, you can further adjust any of the settings to suit your needs as described in the “Note” paragraphs of each section.

When you execute this command, the applicable parameters will be set automatically. You cannot use the COMPARE button to recall the previous settings.

1. Select Auto Sampling Setup to open the dialog box.
2. Press a radio button to select the type of settings you want to make.

**Initialize:** Initializes the sampling-related parameters to their default state.

**Resample Program Play:** Sets the sampling-related parameters to allow you to play a Program and resample your performance.

**REC Audio Input:** Sets the sampling-related parameters so that you can sample an external audio source. With these settings, you can play a Program while sampling, but only the external input will be recorded.

3. These settings will depend on the choice you make in step 2.

### Initialize

If you selected Initialize:

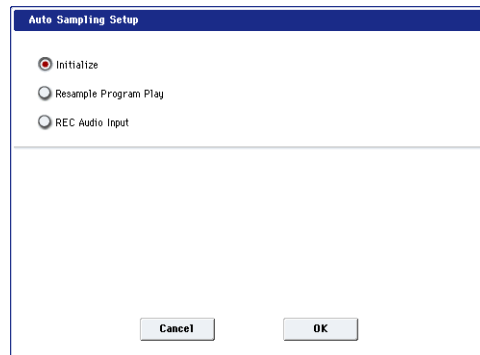

Press the OK button to execute the Initialize operation, or press the Cancel button if you decide not to execute. For more information, see “Automatically-set parameters and their values” on page 152.

### Resample Program Play

If you selected Resample Program Play:

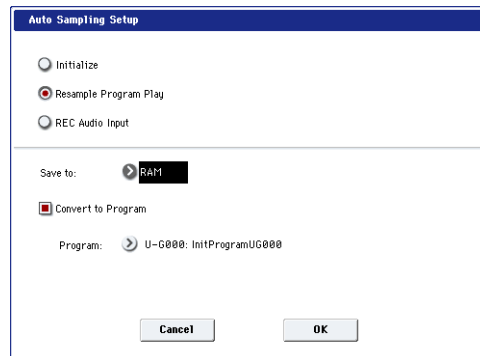

1. Use “Save to” to select either RAM or DISK as the destination to which the resampled data will be written.

If you choose RAM, the sampled data will be written into RAM for use in Sampling Mode. If you choose DISK, the sampled data will be saved to disk as a WAVE file.

2. If Save to is set to RAM, you can also specify whether the sample will be automatically converted to a Program after resampling. If you want to convert the sample, check the "Convert to Program" option, and use "Program" to specify the desired convert-destination program.
3. Press the OK button to execute Resample Program Play. If you decide not to execute, press the Cancel button. (See "Automatically-set parameters and their values" on page 152.)

*Note a: Resample*) To resample, execute Resample Program Play. Then press SAMPLING REC and then SAMPLING START/STOP, and play the program from the keyboard etc. Since "Trigger" (0-8c) is set to Note On, sampling will begin at the first note-on. When you've finished playing, press the SAMPLING START/STOP switch to stop resampling.

*Note b: Check the sampled data*) Verify that your performance was resampled correctly. If you executed with "Save to" RAM and "Convert to Program" checked, select the program you specified as the convert-destination and play the C2 note of the keyboard to hear the sample. If you didn't check "Convert to Program," use Sampling mode to select the sample and listen to it.

If you selected "Save to: DISK," use the page menu command "0-8C: Select Directory" to hear the results.

### Specify the writing destination

When saving the sample to disk, you can use the menu command **Select Directory** to specify the disk and folder to which the sample will be stored. For more information, please see "Select Directory" on page 149.

*Note d: Sampling trigger*) You can use the "Trigger" (0-8c) setting to change the way in which sampling will be started.

*Note e: Sampling multiple sources simultaneously*) If you want to simultaneously sample both an external audio source from AUDIO INPUT together with your own playing on a program, go to the Sampling page, and set the Input 1-4 setting "Bus (IFX/Indiv.) Select" to L/R, and the **Source Bus** to L/R.

*Note f:* If you execute Auto Sampling Setup with "Save to" RAM and the "Convert to Program" option checked, and you continue sampling, each successive sample will be automatically assigned to C2, C#2, D2, ... to create a multisample. A new multisample will be created the next time you execute **Auto Sampling Setup** and start sampling.

### REC Audio Input

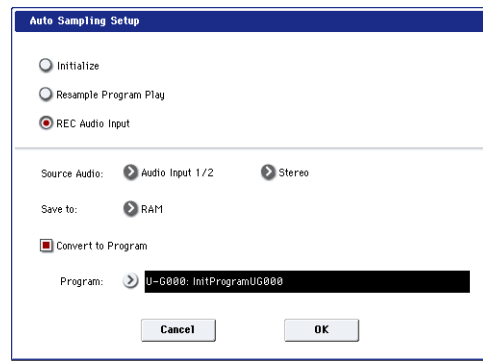

If you selected REC Audio Input:

1. Use "Source Audio" to select the external audio input source.
  - Analog1/2:** Selects the analog audio source connected to the AUDIO INPUT 1 and AUDIO INPUT 2 jacks.
  - Analog3/4:** Selects the analog audio source connected to the AUDIO INPUT 3 and AUDIO INPUT 4 jacks.
  - S/P DIF:** Selects the digital audio source connected to the S/P DIF jack.
2. Use "Mono-L/Mono-R/Stereo" to specify whether the input source is mono or stereo.
  - Mono-L:** Settings will be made for sampling to L-MONO from Input 1 (if you've selected Analog 1/2) or from Input 3 (if you've selected Analog 3/4).
  - Mono-R:** Settings will be made for sampling to R-MONO from Input 2 (if you've selected Analog 1/2) or from Input 4 (if you've selected Analog 3/4).
  - Stereo:** Settings will be made for sampling Input 1/2 or 3/4 in stereo.
3. Use "Save to" to specify the writing-destination for the sampled data. RAM will write the data into Sampling mode. DISK will create a WAVE file of the sampled data, and save it to disk.
4. If you've selected "Save to" RAM, you can specify whether the sample will automatically be converted to a program. If you want the sample to be converted to a program, check "Convert to Program" and use the "Program" field to specify the convert-destination program.
  - 5) If you want to apply an insert effect to the external audio input source while you sample, use "IFX" to select the insert effect you want to use. Turn this off if you don't want to use an insert effect.
  - 6) Press the OK button to execute REC Audio Input. If you decide not to execute, press the Cancel button. (See "Automatically-set parameters and their values" on page 152)

*Note:* To sample, execute REC Audio Input, then press SAMPLING REC, and then START/STOP to begin sampling. (This is because "Trigger" is set to Sampling START SW.) When you're finished, press the SAMPLING START/STOP switch to stop sampling.

If you want to sample while monitoring the performance generated by KARMA, check "Latch" and start sampling while KARMA is playing.

Note: If you've set "Source Audio" to S/P DIF, use **System Clock** (Global 0–2a) to change the system clock.

Note: If you want to apply an insert effect to the input source while you sample, make the following settings. In the Program P0– Sampling page Input 1–4, S/P DIF L/R, use "Bus (IFX/Indiv.) Select" to choose IFX1–IFX12, choose 1/2 as the **REC Bus** following the insert effect you're using, and set **Source Bus** to REC1/2.

For additional information, refer to Note b) under "Resample Program Play" on page 150.

**Automatically-set parameters and their values**

Parameter		1. Initialize	2.REC Audio Input	3.Auto Resample through IFX
Input (Input Source)		Analog, S/P DIF*1	(Source Audio)*2	Analog, S/P DIF*1
Input1	Level	127		
	Pan	L000		
	Bus Select	Off	(IFX)*3	Off
	Send1	000		
	Send2	000		
Input2	Level	127		
	Pan	R127		
	Bus Select	Off	(IFX)*3	Off
	Send1	000		
	Send2	000		
Recording Setup	Source Bus	L/R		
	Trigger	Sampling START SW		
	Metronome Precount	Off	-	-
	Resample	Manual	Manual	Auto
REC Sample Setup	Save to	RAM	(Save to)	(Save to)
	Sample Mode	L-MONO	(Source Audio)*4	Stereo
	Sample Time: RAM	Maximum	-	-
	Sample Time: DISK	4min 59.999sec	-	-
	Recording Level [dB]	+0.0	+0.0	-12.0
REC Sample Preference	Auto +12dB On	Off	Off	On
Bus Select (P8 Routing)	All OSCs to	L/R	L/R	(IFX)

- : Not set automatically

Values enclosed in parentheses ( ) are automatically set according to the settings you make in the dialog box.

\*1: Settings for Analog, S/P DIF ("Input 1" and "Input 2") are made automatically.

\*2: The input source setting ("Input 1" and "Input 2") you specified for "Source Audio" in the dialog box will be set automatically.

\*3: If "Source Audio" is Mono-L this will be L-Mono, if Mono-R this will be R-Mono, and if Stereo this will be Stereo.

\*4: When "Save to: RAM," and "Convert to Program" is checked.

**Copy Tone Adjust**

Copy Tone Adjust is available on the Control Surface page when CONTROL ASSIGN is set to **Tone Adjust**.

This command replaces the current Tone Adjust settings with those of any other Program, Combination Timbre, or Song Track.

1. Select "Copy Tone Adjust" to open the dialog box.

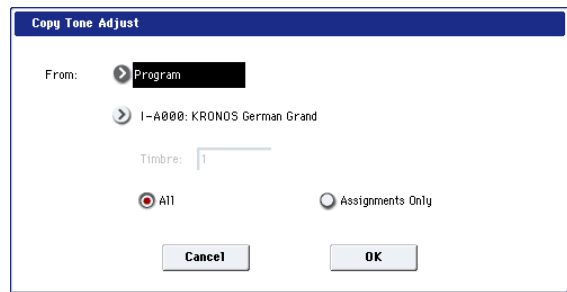

2. Use "From" to select the copy-source mode, bank, and number.

You can use the front-panel BANK keys to select the desired bank.

3. In the **Timbre** field (if you've selected a **Combination**) or **Track** field (if you've selected a **Song**), select the **Timbre** or **Track** to copy from.

4. Select either **All** or **Assignments Only** to specify the **Tone Adjust** parameters you want to copy.

**All:** This copies both the **Tone Adjust** parameter assignments and values.

**Assignments Only:** This copies only the **Tone Adjust** parameter assignments, without the values.

5. Press the **OK** button to execute the **Copy Tone Adjust** command, or press the **Cancel** button if you decide to cancel.



## Reset Tone Adjust

**Reset Tone Adjust** is available on the Control Surface page when **CONTROL ASSIGN** is set to **Tone Adjust**.

This command changes the Tone Adjust assignments for all of the Knobs, Switches, and Sliders at once, either resetting them to default values or turning them all off.

1. Select **“Reset Tone Adjust”** to open the dialog box.

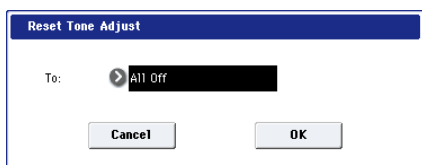

2. Use the **“To”** field to specify how the Tone Adjust assignments will be reset.

**All Off:** All Knob, Switch, and Slider assignments will be set to Off.

**Default Setting:** The assignments will be reset to the defaults, which will vary depending on the type of Program (HD-1 or EXi), and for EXi Programs only, on whether the Program uses one or two EXi.

Single EXi Programs will use the default assignments for their EXi. Assignments for double EXi Programs are turned Off except for the EXi Common parameters.

For details on the default Tone Adjust assignments, see:

- **“HD-1 Tone Adjust Parameters”** on page 33
- **“AL-1: Tone Adjust”** on page 222
- **“CX-3: Tone Adjust”** on page 244
- **“STR-1: Tone Adjust”** on page 292
- **“MS-20EX: Tone Adjust”** on page 319
- **“PolysixEX: Tone Adjust”** on page 335
- **“MOD-7: Tone Adjust”** on page 385
- **“SGX-1: Tone adjust”** on page 393
- **“EP-1: Tone Adjust”** on page 413

3. To execute the **Reset Tone Adjust** command, press the **OK** button. To exit without resetting the assignments, press the **Cancel** button.

## Copy Oscillator

**Copy Oscillator** is available on all of the tabs under the Basic/Vector, OSC/Pitch, Filter, Amp/EQ, and AMS Mix/Common Key Track pages.

This command is used to copy the settings from one oscillator to another.

1. Select **“Copy Oscillator”** to open the dialog box.

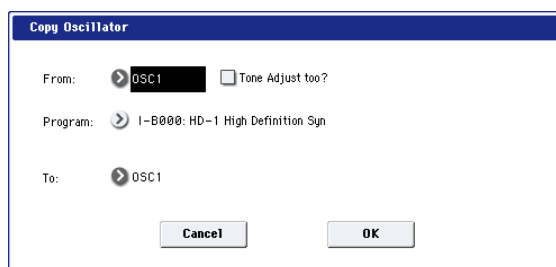

2. Use the **“From”** field to select the oscillator that you want to copy.
3. Use **“Program”** to select the bank and number of the copy-source program. You can press a **BANK SELECT** switch to select the desired bank.  
*Note:* If you’re editing an HD-1 Program, you can’t select EXi Programs, and vice-versa.
4. If you check **“Tone Adjust too,”** the Tone Adjust settings will temporarily be turned off, and from the copy-source Tone Adjust settings, the Common portion and the assignments and current values of the corresponding OSC portion will be copied.  
If **“Tone Adjust too”** is unchecked, the Tone Adjust settings will be maintained.
5. In **“To,”** specify the copy destination oscillator.
6. To execute the **Copy Oscillator** command, press the **OK** button. To cancel, press the **Cancel** button.

## Swap Oscillator

**Swap Oscillator** is available on all of the tabs under the Basic/Vector, OSC/Pitch, Filter, Amp/EQ, and AMS Mix/Common Key Track pages.

This command exchanges the settings of oscillators 1 and 2.

1. Select **“Swap Oscillator”** to open the dialog box.
2. To execute the **Swap Oscillator** command, press the **OK** button. To cancel, press the **Cancel** button.

This can be selected only if **Oscillator Mode (1-1a)** is Double.

## Copy Vector Envelope

**Copy Vector Envelope** is available on the Vector Envelope tab of the Basic/Vector page.

This command copies vector envelope settings from the specified program, combination/timbre, or song.

1. Select **“Copy Vector Envelope”** to open the dialog box.

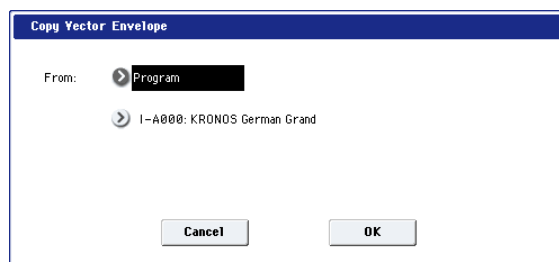

2. Use the “From” field to select the mode, bank, and number of the desired copy-source. You can press a BANK key to select the desired bank.

This command copies the parameters of the P1-Vector Envelope page of the corresponding mode.

*Note:* In order to replicate the way in which the relative volume of oscillators is controlled by the vector and vector envelope of the program selected for a combination timbre or a MIDI song track, turn on the Enable Program Vector Volume check box in the Vector Control Volume page. To replicate the CC control effects, turn on the Enable Program Vector CC check box in the Vector Control CC page.

Use this command when you want to copy the Position or Time/Tempo of a vector envelope in order to create an envelope that produces the same movement.

3. Press the OK button to execute the command, or press the Cancel button to cancel.

## Copy Pad Setup

Copy Pad Setup is available on the Pads tab of the Basic/Vector page.

This command copies the pad settings of the specified Program, Combination, or Song.

1. Select Copy Pad Setup to open the dialog box.

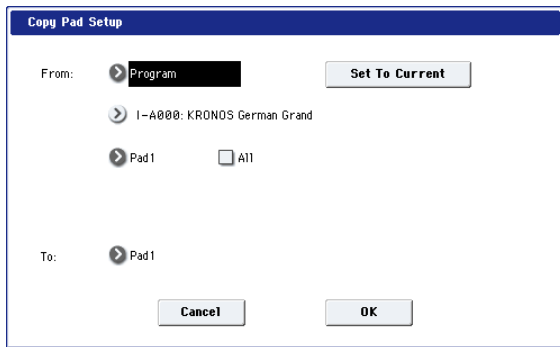

2. Use the “From” field to select the mode, bank, and number of the desired copy-source. You can also select Banks via the front-panel BANK SELECT buttons.

If you press the Set To Current button, the currently selected mode, bank, number and pad (edit cell) will automatically be assigned to the From field. This is useful when you’re trying out other pad settings and want to temporarily copy previously-edited pad settings to another vacant pad.

3. Select the copy-source pad number. If you want to copy all settings for pads 1–8, check the All option.
4. Use the “To” field to specify the copy-destination pad.

*Note:* Executing this command will copy the note number and velocity value. The MIDI channel is not copied.

5. Press the OK button to execute the Copy Pad Setup command, or press the Cancel button to cancel.

## Sample Parameters

Sample Parameters is available on the OSC 1/2 Basic pages.

This command lets you adjust various parameters for the individual samples within a Sampling Mode Multisample, including volume level, cutoff, resonance, pitch, EG attack and decay, drive and low boost, and EQ gains.

The Sample Parameters command is available only if you’ve selected a Sampling Mode Multisample; it is not available for ROM, EXs, or User Sample Bank Multisamples, Wave Sequences, or Drum Kits.

When you’ve finished editing the parameters, press the Done button. Please note that Compare is not available for edits made in this dialog box.

*Note:* The Sample Parameters settings apply everywhere that the Multisample is used, and not just to the current Program. If another Program uses the same Multisample, it will also be affected by any changes that you make here.

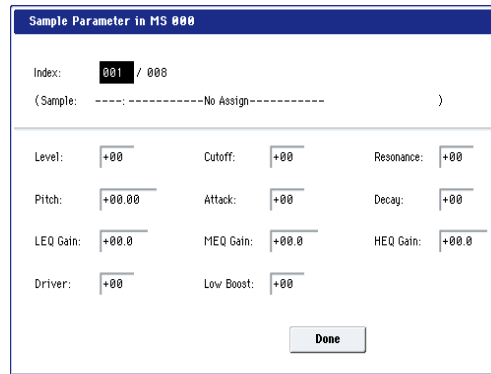

### Index [001...128]

An Index is a key zone in a Multisample, including a single Sample and all of its associated parameters. This is the currently selected Index.

The number following “/” is the total number of indexes in the current Multisample.

### Sample [000]

This is the number and name of the Index’s Sample.

### Level [-99...+00...+99]

This adjusts the volume of the Sample, relative to the Oscillator’s settings. **Negative** (–) values will decrease the levels, and **positive** (+) values will increase the levels. A setting of +99 will double the volume. This is the same as the index Level parameter in Sampling mode; edits here will affect the values shown in Sampling mode, and vice-versa.

Each Sample also has a +12dB setting, as configured in Sampling mode; if this is on, the Sample will play back approximately 12dB louder. For more information, see “+12dB” on page 701.

### Cutoff [-99...+00...+99]

This adds to, or subtracts from, the Oscillator’s filter cutoff settings.



**Resonance** [-99...+00...+99]

This adds to, or subtracts from, the Oscillator’s filter resonance settings.

**Pitch** [-64.00...+00.00...+63.00]

This adjusts the playback pitch in one-cent steps. A setting of +12.00 raises the pitch one octave, and a setting of -12.00 lowers the pitch one octave. This is the same as the index **Pitch** parameter in Sampling mode; edits here will affect the values shown in Sampling mode, and vice-versa.

**Attack** [-99...+00...+99]

This adds to, or subtracts from, the attack times of the filter EG and amp EG.

**Decay** [-99...+00...+99]

This adds to, or subtracts from, the attack times of the filter EG and amp EG.

**Driver** [-99...+00...+99]

This adds to, or subtracts from, the Oscillator’s Driver setting. If the Driver circuit is bypassed, this will have no effect.

**Low Boost** [-99...+00...+99]

This adds to, or subtracts from, the Oscillator’s Low Boost setting. If the Driver circuit is bypassed, this will have no effect.

**LEQ Gain** [-36dB...+00...+36dB]

This adds to, or subtracts from, the Program’s Low EQ gain setting. If the EQ is bypassed, this will have no effect.

**MEQ Gain** [-36dB...+00...+36dB]

This adds to, or subtracts from, the Program’s Mid EQ gain setting. If the EQ is bypassed, this will have no effect.

**HEQ Gain** [-36dB...+00...+36dB]

This adds to, or subtracts from, the Program’s High EQ gain setting. If the EQ is bypassed, this will have no effect.

---

**Sync Both EGs**

**Sync Both EGs** is available on the Filter 1/2 EG and Amp 1/2 EG pages.

This option allows you to edit the EGs of Oscillator 1 and Oscillator 2 together. When it is checked, editing the Filter EG of either Oscillator 1 or 2 will change both Filter EGs simultaneously. Similarly, editing the Amp EG of either Oscillator will change both Amp EGs.

This option is available only when the **Oscillator Mode** is set to **Double**.

**1. Select “Sync Both EGs.”**

The LCD screen will indicate “Sync Both EGs,” and the two EGs will be synchronized.



**2. If you no longer want the EGs to be synchronized, select “Sync Both EGs” once again.**

The indication will disappear from the LCD screen.

---

**Swap LFO 1&2**

**Swap LFO 1 & 2** is available on all of the LFO pages, except for the Common LFO tab.

This command copies the settings of LFO1 to LFO2, and vice-versa.

*Note:* If LFO2 is being used to modulate LFO1, this command will erase that modulation routing (since the LFOs cannot modulate themselves).

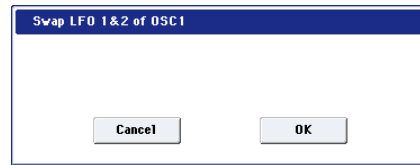

After opening the dialog box, press the OK button to swap the LFO settings, or press the Cancel button to close the dialog box without making any changes.

---

**Copy KARMA Module**

**Copy KARMA Module** is available on all of the KARMA pages, as well as the KARMA GE tab of the Play page.

This command copies the settings of the KARMA Module used by a specified program, combination, or song.

**1. Select “Copy KARMA Module” to open the dialog box.**

**2. In “From,” select the copy source mode, bank, and number.**

You can use the front panel BANK SELECT switches to select the bank.

**3. If you selected a combination or song as the copy-source, select the module from which you want to copy.**

**4. As appropriate for the content that you want to copy, turn “GE RTP Control Setting & Scenes” On (checked).**

For more information, see “Settings copied by “Copy KARMA Module”,” below.

**5. If you want to copy performance realtime parameters, Dynamic MIDI, and front panel settings, turn “Perf. RTP & Panel Settings” On (checked).**

**6. If you want to copy the note and velocity settings of pads 1–8, turn “Pads” on.**

**7. Press the OK button to execute the Copy KARMA Module command, or press the Cancel button if you decide to cancel.**

## Settings copied by “Copy KARMA Module”

### When copying from a program

If “GE RTP Control Setting & Scenes” and “Perf. RTP & Panel Settings” are Off (checked), the following content is copied.

- The GE selected by the copy-source KARMA module.
- Settings of the KARMA module parameters (7-3: Module Parameter-Trigger, 7-4: Module Parameter-Control).
- 7-5: GE RTP page “MIN,” “MAX,” and “VALUE” settings.

### If you turn “GE RTP Control Setting & Scenes” On (checked)

In addition to the content copied when “GE RTP Control Setting & Scenes” is Off (unchecked), the following content is copied.

- 7-5: GE RTP page “ASSIGN” and “POLARITY” settings.
- The scene selected in the master buffer, the KARMA CONTROLS slider and KARMA SWITCH settings of each scene (0-6d: Realtime Controls and 0-9f: R.Time Knobs/KARMA settings).
- 7-8: Name/Note Map controller name settings.

### If you turn “Perf. RTP & Panel Setting” On (checked)

In addition to the content copied when “Perf. RTP & Panel Settings” is Off (unchecked), the following content is copied.

- “Tempo” setting.
- “Time Signature” setting.
- KARMA ON/OFF switch setting.
- KARMA LATCH switch setting.
- 7-5: GE Real-Time Parameters/Scene page, Drum Track Run setting.
- 7-6: Perf Real- Time Parameters page settings.
- 7-7: Dynamic MIDI page settings.

### When copying from a combination or song

If “GE RTP Control Setting & Scenes” and “Perf. RTP & Panel Settings” are Off (unchecked) when you copy from a combination or song, the following content is copied.

- The GE selected for the copy-destination KARMA module (including the GE realtime parameters).
- KARMA module parameters (7-3: Module Parameter-Trigger, 7-4: Module Parameter-Control).
- 7-5: GE RTP page “MIN,” “MAX,” and “VALUE” settings.

### If you turn “GE RTP Control Setting & Scenes” On (checked)

In addition to the content copied when “GE RTP Control Setting & Scenes” is Off (unchecked), the following content is copied.

- 7-5: GE RTP page “ASSIGN” and “POLARITY” settings.

- The KARMA CONTROLS slider and KARMA SWITCH settings of each scene in the copy-source buffer, and the currently selected scene.
- 7-8: Names/Note Map controller name settings.

### If you turn “Perf. RTP & Panel Setting” On (checked)

In addition to the content copied when “Perf. RTP & Panel Settings” is Off (unchecked), the following content is copied.

- “Tempo” setting.
  - “Time Signature” setting.
  - KARMA ON/OFF switch setting.
  - KARMA LATCH switch setting.
  - KARMA Module Control switch setting.
  - 7-5: GE Real-Time Parameters/Scene page, Drum Track Run setting.
  - 7-6: Perf Real- Time Parameters page settings.
  - 7-7: Dynamic MIDI Page settings.
-  The “Input Channel” and “Output Channel” (Combination/Sequencer P7-1) settings of a combination or song are not copied.

---

## Initialize KARMA Module

**Initialize KARMA Module** is available on all of the KARMA pages, as well as the KARMA GE tab of the Play page.

This command sets the KARMA Module’s parameters to their default values.

-  The GE selection will not be initialized. The GE parameters will be set to the selected GE’s default values.

1. Select “Initialize KARMA Module” to open the dialog box.
2. As appropriate for the settings you want to initialize, you can turn on (check) the “GE RTP Control settings & Scenes” and/or “Perf. RTP” options.

For more information, see “Settings initialized by Initialize KARMA Module,” below.

3. To initialize the settings, press the OK button. To cancel without initializing, press the Cancel button.

### Settings initialized by Initialize KARMA Module

If you initialize with the **GE RTP Control Settings & Scenes** and **Perf. RTP** options turned off (unchecked), the following parameters will be initialized.

- 7-1-4, 8 module parameters.
- 7-5: GE Real- Time Parameters page “MIN,” “MAX,” and “VALUE” (they will return to the values preset by the GE).

-  The GE selection will not be initialized.

If you initialize with “GE RTP Control Settings & Scenes” turned on (checked):

In addition to the parameters listed above, the following parameters will also be initialized.

- 7-5: GE Real-Time Parameters page "ASSIGN" (→Off) and "POLARITY" (→+).
- KARMA CONTROLS slider and KARMA SWITCH settings in each scene (→064/0).
- KARMA CONTROLS slider and KARMA SWITCH names (→no name).

If you initialize with "Perf. RTP" turned on (checked):  
In addition to the parameters initialized with the Off (unchecked) setting, the following parameters will also be initialized.

- 7-5: GE Real-Time Parameters/Scene page, Drum Track Run setting.
- 7-6: Perf Real-Time Parameters page parameters.
- 7-7: Dynamic MIDI page parameters.

## Copy Scene

**Copy Scene** is available on all of the KARMA pages, as well as the KARMA GE tab of the Play page. It's also available on the Control Surface page, when **CONTROL ASSIGN** is set to **Real-Time Knobs/KARMA**.

This command copies settings for the KARMA Scenes. You can use this command when you want to make settings for a scene based on the other scene settings you edited, or vice versa.

1. Choose "Copy Scene" to open the dialog box.
2. In "From:" select the scene that you wish copy.
3. In "To:" select the copy destination scene.
4. To execute the copy, press the OK button. To cancel without executing, press the Cancel button.

## Swap Scene

**Swap Scene** is available on all of the KARMA pages, as well as the KARMA GE tab of the Play page. It's also available on the Control Surface page, when **CONTROL ASSIGN** is set to **Real-Time Knobs/KARMA**.

This command swaps (exchanges) the settings of two KARMA Scenes.

1. Choose "Swap Scene" to open the dialog box.
2. In "Source1" and "Source2", select two KARMA Scenes. that you wish to swap.
3. To execute the swap, press the OK button. To cancel without executing, press the Cancel button.

## Capture Random Seed

**Capture Random Seed** is available on all of the KARMA pages, as well as the KARMA GE tab of the Play page.

The **Start Seed** is the source of the randomness of the phrase generated by the KARMA Module. For more information, see "Start Seed" on page 126.

When you are listening to the randomly changing phrases generated each time a KARMA Module is triggered, and you hear a phrase that you would like to

reproduce consistently each time you trigger that GE, you can execute this command to capture the seed that resulted in that phrase.

For more information, see "Checking the Freeze Randomize function, and performing "Capture Random Seed"" on page 157.

1. Select "Capture Random Seed" to open the dialog box.

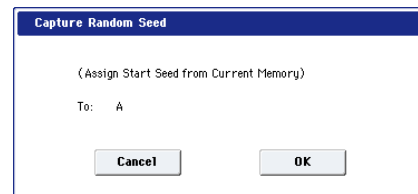

2. If you are in a mode that can use more than one KARMA Module (Combination or Sequencer modes), use "To:" to select the module for which you want to capture the seed value.

If you select A–D, the seed value will be captured for that KARMA Module. If you select All, the seed values will be captured for all four KARMA Modules.

In Program mode, this is fixed at A.

3. To execute the Capture Random Seed, press the OK button. To cancel without executing, press the Cancel button.

⚠ If the "Start Seed" parameter (see "Start Seed" on page 130) of the KARMA Module for which you execute Capture Random Seed is assigned as a Perf Real-Time Parameter (see "7-6b: Perf Real-Time Parameters" on page 123), the message "Could not execute Capture Random Seed because the selected Start Seed is assigned as an RTParm" will be displayed, and Capture Random Seed will not be executed. (Press the OK button to close the message.)

If you set the "To:" field of the dialog box to ALL (Combination, Sequencer mode) to execute Capture Random Seed for all KARMA Modules, Capture Random Seed will be executed only for the KARMA Modules whose "Start Seed" parameter is not assigned as an Perf Real-Time Parameter. If the "Start Seed" parameter of any KARMA Module is assigned as a Perf Real-Time Parameter, Capture Random Seed will not be executed for those KARMA Modules.

## Checking the Freeze Randomize function, and performing "Capture Random Seed"

By using the "Capture Random Seed," "Start Seed" (7-8b), and "Freeze Loop Length" (7-8b) settings, you can loop a randomly changing phrase as desired, or generate the same phrase each time you trigger the GE.

### Procedure

An example of the procedure in Program mode is shown below.

1. In Program mode, select USER-B061: Widow Maker.



2. Turn the front panel KARMA ON/OFF switch on.
3. Press the Common button to access the 7-4: Module Parameters- Trigger page, and set "Note Trigger" to Any.

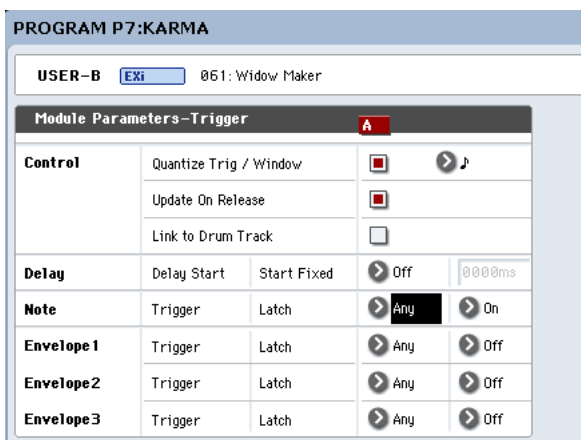

4. Turn the front panel KARMA LATCH switch on.
5. Use an on-screen pad or the keyboard to trigger GE "0267: Improv Lead " for the KARMA Module.  
The phrase generated by this GE will always change randomly (each time you trigger it, or each time the phrase is repeated).
6. Select the Program P7-8: Random Seeds page.

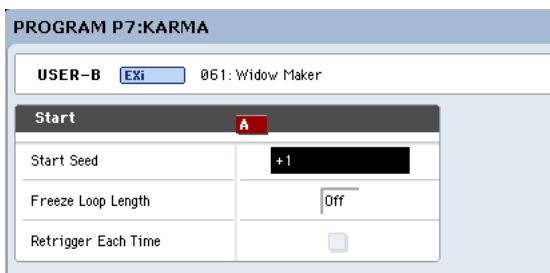

7. Set "Start Seed" to 1 (+000000001).  
Retrigger the Chord trigger. Each time it will play the same randomized phrase; however, if you let it continue, it will always make new randomizations as it goes along.
8. Set "Freeze Loop Length" to 2 (2 bars).  
Now, every 2 bars, it will loop and repeat the exact same series of randomizations that is specified by "Start Seed" 1. However, this particular GE has a Phase Pattern of 8 steps (bars), so it may not sound always as if it is restarting every 2 bars, because of the internal settings of the Phase Pattern. It will repeat the same randomizations, but not necessarily

restart the riff from the beginning. However, this can also be useful for getting the same rhythm and note movements, with a longer evolving phrase.

9. Set "Retrigger Each Time" to On (checked).

Now, every 2 bars, the Phase Pattern is restarted also, in conjunction with the Freeze Loop length, and the phrase becomes a simple 2 bar loop.

10. Set "Start Seed" back to 0: Random.

Retrigger the phrase by pressing an on-screen pad or playing the keyboard. A completely new randomized phrase will be generated each time you trigger, but every 2 bars it will loop and repeat until you trigger it again.

11. Now set "Retrigger Each Time" back to Off (unchecked).

Once again, even though the randomizations are being repeated every 2 bars, the 8 step GE Phase Pattern allows longer evolving phrases to be created.

12. Set the "Freeze Loop Length" parameter.

If you set this to 1-32, the phrase will loop for the specified number of measures. For this example, set this to 2 and set the "Retrigger Each Time" to On (checked). With this setting, the random phrase will freeze to a two-measure phrase. You can use this to loop a phrase during a live performance.

13. In the same way as in step 5, use the on-screen pad or keyboard to trigger the KARMA Module.

14. When you hear a phrase you want to be played each time you trigger the GE, execute "Capture Random Seed." Press the Page Menu button and choose "Capture Random Seed" from the page menu.

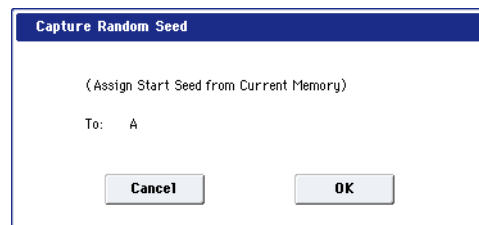

15. When the dialog box appears, press the OK button.

The "Start Seed" parameter will automatically be set to the internal value needed to reproduce the phrase.

Example: Capture Random Seed has set "Start Seed" to a value of +0254861235



Note: "Seed" is the source data from which the randomizations are created. The "Seed" of the phrase being looped is automatically set internally within the



KARMA Module as the “Start Seed.” The “Start Seed” is used each time the GE is triggered. This means that each time you trigger the GE, a specific “Seed” is always used to generate the phrase.

**16. Press the KARMA ON/OFF switch to temporarily turn off KARMA. Then press the KARMA ON/OFF switch once again to turn KARMA back on.**

**17. In the same way as in step 5, use the on-screen pad or keyboard to trigger the KARMA Module.**

The phrase that was looped in step 11 will be reproduced each time the module is triggered. You can now save the Program and recall this phrase at any time.

## Copy Insert Effect

Copy Insert Effect is available on all of the IFX pages.

This command copies effects settings from within the current Program, from other Programs, Combinations, or Songs, or from the current Sampling mode settings.

To execute the Copy Insert Effect command, press the **OK** button. To cancel, press the **Cancel** button.

 If you're copying from a master effect, the result will not be identical due to differences in the routing and level settings of the master effects.

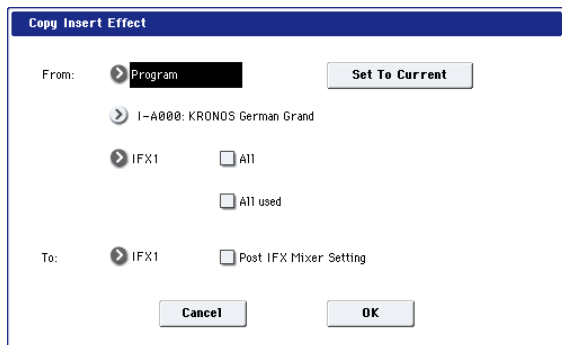

**From (Mode)** [Program, Combination, Song, Sampling Mode]

This selects whether you'll copy from a Program, a Combination, a Song, or the current Sampling Mode settings.

**From (Bank and Number)** [Bank and Number]

For Programs and Combis, this selects the Bank and Number from which to copy. When this parameter is selected, you can also use the front-panel BANK buttons to select Banks.

**Set to Current** [button]

Pressing the **Set To Current** button sets the **From** fields to the currently selected mode, bank, number, and IFX slot.

This can be useful, for instance, for backing up the current IFX settings to a vacant IFX slot. You can then try out other effects settings, and still be able to return to the previous settings if necessary.

**(Effects slot select)** [IFX 1...12, MFX 1&2, TFX 1&2]

Select which of the effects you wish to copy.

You can also copy from a master effect and total effect.

**All** [check-box]

When this is enabled, the settings of all insert effects (the contents of the Insert FX page and the effect parameters of IFX1–12, but not **Ctrl Ch**) will be copied.

**All Used** [check-box]

When this is enabled, only the insert effects (IFX1–12) that are actually used by the copy-source will be copied.

In the copy-destination, the effect settings will be copied into vacant slots (i.e., slots with 000: No Effect, unless they exist within a chain) starting with the insert effect specified by the **To** field.

**To** [IFX 1...12]

This selects the insert effect copy destination.

**Post IFX Mixer Settings** [check-box]

When this is checked, the **Pan**, **Bus Sel.**, **Ctrl Bus**, **REC Bus**, and **Sends 1** and **2** settings that follow the copy source insert effect will also be copied.

When this is not checked, only the effect type and its parameters will be copied.

**Copying 000: No Effect**

Copying a single effect set to “000: No Effect” will not work: no data will be copied.

If either **All** or **All used** is selected, and “000: No Effect” exists within a chain, it will be copied. However, if the entire chain consists of “000: No Effect,” nothing will be copied.

## Swap Insert Effect

Swap Insert Effect is available on all of the IFX pages.

This command exchanges the effects, and their internal parameters, between two IFX slots.

All of the parameters shown on the IFX 1-12 pages will be copied.

Other IFX slot parameters will not be affected, including **Pan**, **Sends 1** and **2**, **Chain**, **REC Bus**, and **FX Control Bus**.

**1. Select “Swap Insert Effect” to open the dialog box.**

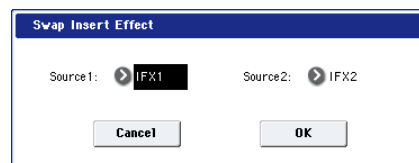

**2. In “Source 1” and “Source 2,” select each of the insert effects that you wish to swap.**

**3. To execute the Swap Insert Effect command, press the OK button. To cancel, press the Cancel button.**

## Insert IFX Slot

Insert IFX Slot is available on the Routing and Insert FX tabs of the IFX page.

This command inserts an IFX slot.

Slots located after the inserted location will be relocated downward if a vacant slot exists. At this time, **Chain**, **Pan (CC#8)**, **REC Bus**, **FX Control Bus**, **Send 1/2**, and **Ctrl Ch** (only for Combi and SEQ) will also be relocated.

This command also provides an Auto Routing option that automatically adjusts related parameters in order to preserve the previously-existing routing.

This command is convenient when you want to add an effect within a chain of insert effects.

### 1. In the Insert FX page, select the IFX slot in front of which you want to insert an effect.

In this example, IFX1→IFX2→IFX3→IFX4→IFX5 are chained, and we are going to insert a slot in front of IFX3 so that we can add another IFX.

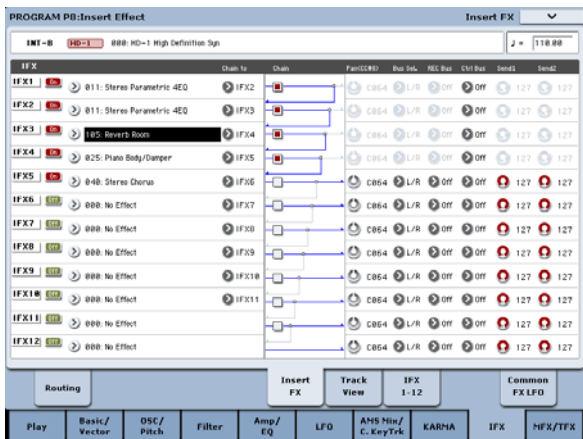

### 2. Alternatively, you can insert an effect slot from within the Track View page.

Select the insert effect slot in front of which you want to insert an effect.

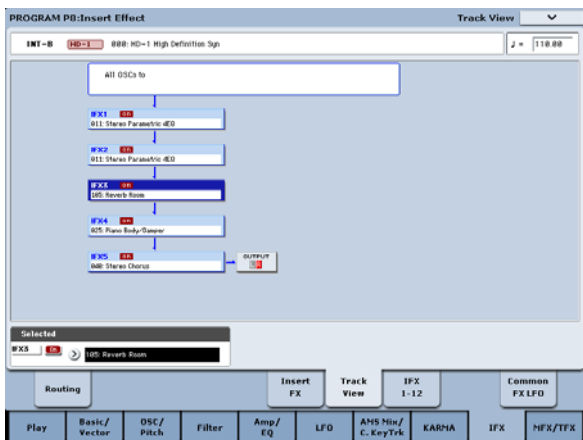

*Note:* In Combi or Seq modes, this Track View page is a convenient way to check the IFX that are chained for each timbre or track, and the Insert FX command can be used in this page as well to edit the effect settings of each timbre or track. When you do so, the routing will be adjusted automatically so that

the settings of other timbres or tracks will remain the same.

### 3. Select “Insert IFX Slot” to open the dialog box.

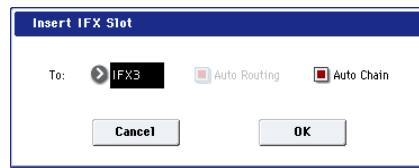

### 4. Use the “To” field to specify the IFX number at which you want to insert a slot. (The IFX you selected in step 1 or 2 will be shown here as the default.)

Specify the “Auto Routing” and “Auto Chain” options. Normally you will leave these on.

**Auto Routing:** This automatically adjusts the following parameters in order to preserve the currently-existing routing.

- Routing: Bus Select
- Routing- Page Menu: DKit Patch (Combi/SEQ)

## Auto Routing always enabled on the Track View page

You can’t change the **Auto Routing** setting if you’ve executed the Insert IFX Slot command from the Track View page. The command will always be executed with this option On.

## Drum Kits not supported by Auto Routing

Drum Kits can store separate **Bus Select** settings for each key. Because these settings are stored in the Drum Kit, and not the Program, the **Auto Routing** option can’t correct them.

Drum Kit Programs will use these separate **Bus Select** settings if the IFX Routing page’s **Use DKit Setting** parameter is turned On.

In this case, you have two options. Either:

- Use **Auto Routing**, and then manually adjust the **Bus Select** settings for each key of the Drum Kit to match the new IFX slot arrangement.

or:

- Don’t use the **Insert IFX Slot** command. Instead, remove the unwanted IFX slot by changing the **Chain to** settings, or by using the **Copy IFX** or **Swap IFX** commands.

**Auto Chain: on:** If the IFX you’ve inserted is located within a chain, the **Chain** setting will automatically be turned on for the inserted IFX so that it will be chained with the preceding and following IFX.

If the IFX you’ve inserted is not inside a chain, **Auto Chain** does nothing.

### 5. Press the OK button to execute the Insert IFX Slot command, or press the Cancel button to cancel.

⚠ If there are not enough IFX units to insert, pressing the OK button will simply exit the command without doing anything.

In this example, 000: No Effect will be inserted into IFX3 when you execute the command. The effects that were at IFX3–IFX5 will be relocated to IFX4–6, resulting in a chain consisting of IFX1–IFX6.

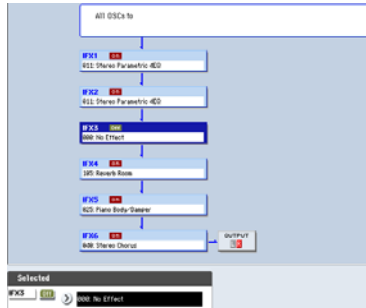
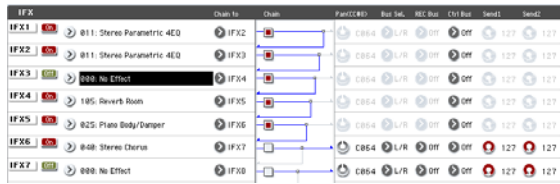

6. For the newly inserted slot, turn the On/Off setting On. Then select and edit the desired effect.

### Cut IFX Slot

Cut IFX Slot is available on the Routing and Insert FX tabs of the IFX page.

This command removes an IFX slot, and moves the other IFX upwards to fill in the gap—convenient when you want to remove an effect that you’re not using.

When the IFX are moved upwards, all of their related settings are copied as well. This includes **Chain**, **Pan**, **REC Bus**, **FX Control Bus**, **Sends 1 and 2**, and (for Combis and Songs only) **Ctrl Ch**.

This command also provides an Auto Routing option that automatically adjusts related parameters in order to preserve the previously-existing routing.

1. In the Insert FX page, select the insert effect slot that you want to remove.

In this example, IFX1→IFX2→IFX3→IFX4→IFX5 are chained, and we are going to remove the IFX3 slot.

You can also perform this operation from within the Track View page. Select the insert effect slot that you want to remove.

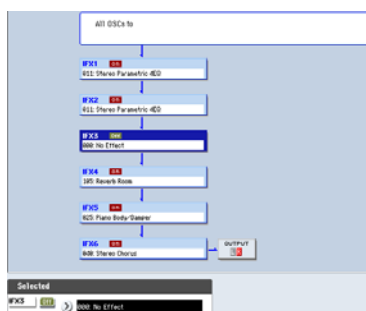

2. Select “Cut IFX Slot” to open the dialog box.

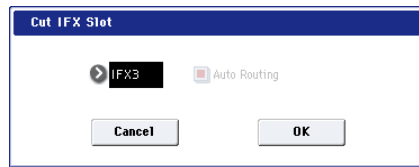

3. Specify the number of the IFX you want to remove.

(The IFX you selected in step 1 or 2 will be shown here as the default.)

4. Specify the “Auto Routing” option. Normally you will leave this on.

**Auto Routing:** This automatically adjusts the following parameters in order to preserve the currently-existing routing.

- Routing: Bus Select
- Routing- Page Menu: DKit Patch (Combi/SEQ)

You can’t change the Auto Routing option if you’ve executed the “Cut IFX Slot” command from the Track View page. The command will always be executed with this option On.

5. Press the OK button to execute the Cut IFX Slot command, or press the Cancel button to cancel.

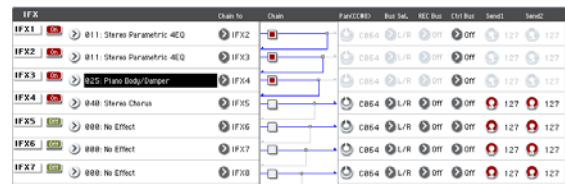

### Drum Kits not supported by Auto Routing

Drum Kits can store separate **Bus Select** settings for each key. Because these settings are stored in the Drum Kit, and not the Program, the **Auto Routing** option can’t correct them.

Drum Kit Programs will use these separate **Bus Select** settings if the IFX Routing page’s **Use DKit Setting** parameter is turned **On**.

In this case, you have two options. Either:

- Use **Auto Routing**, and then manually adjust the **Bus Select** settings for each key of the Drum Kit to match the new IFX slot arrangement.

or:

- Don’t use the **Cut IFX Slot** command. Instead, remove the unwanted IFX slot by changing the **Chain to** settings, or by using the **Copy IFX** or **Swap IFX** commands.



## Clean Up IFX Routings

Clean Up IFX Routings is available on the Insert FX and Track View tabs of the IFX page.

This command automatically rearranges unused IFX slots so that they are consecutive. It also rearranges effects in a discontinuous chain so that they are consecutive. Related parameters are automatically adjusted in order to preserve the existing routings.

If editing an IFX chain results in unused slots, or if the connections in a chain have become disorganized, you can execute this command to clean up the routing.

### 1. Access the Insert FX page.

In this example, IFX1→IFX5→IFX11→IFX12 are chained, and the remaining slots are all vacant.

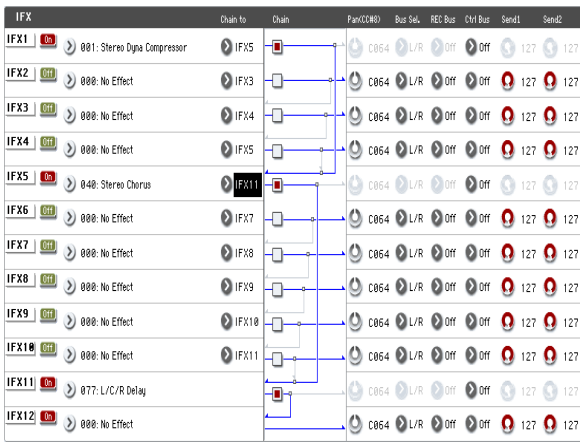

### 2. Alternatively, you can execute this command from the Track View page.

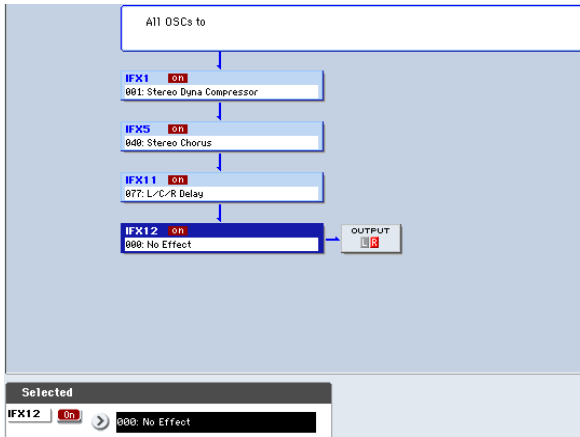

### 3. Select “Clean Up IFX Routings” to open the dialog box.

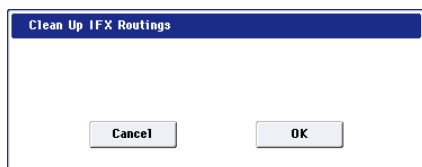

### 4. Press the OK button to execute the Clean Up IFX Routings command, or press the Cancel button if you decide to cancel.

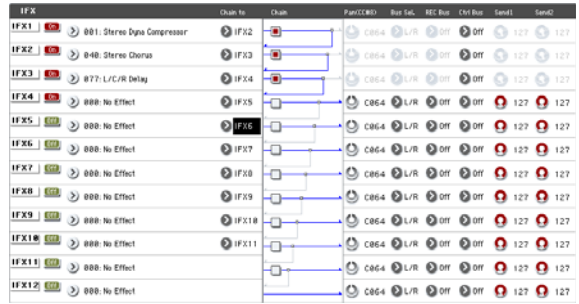

In this example, the discontinuous chain IFX1→IFX5→IFX11→IFX12 has been reorganized into IFX1→IFX2→IFX3→IFX4, and the vacant slots (000: No Effect, unless located within a chain) have been rearranged consecutively.

At this time, the following parameters are automatically adjusted to maintain the existing routings.

- Routing: Bus Select
- Routing- Page Menu: DKit Patch (Combi/Seq)

⚠ If the program uses a drum kit, and the Routing page “Use DKit Setting” is on, you may have to change the **Bus Select** setting for each key of the drum kit in order to reproduce the previous routing status.

In such cases, don’t use the “Clean Up IFX Routings” command. Instead, rearrange the IFX slots by making the appropriate **Chain to** settings or by using the “Copy Insert Effect” or “Swap Insert Effect” commands.

## Copy MFX/TFX

Copy MFX/TFX is available on all of the MFX/TFX pages.

This command lets you copy any desired effect settings from Program, Combination, Song, or Sampling mode.

### 1. Select “Copy MFX/TFX” to open the dialog box.

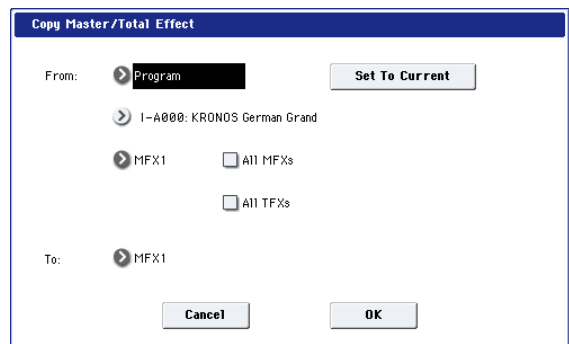

- In "From," select the copy source mode, bank, and number.

You can also use the BANK SELECT switches to select the desired bank.

If you press the "Set To Current" button, the currently selected mode, bank, number, and MFX/TFX (edit cell) will automatically be assigned to the "From" field. This is useful when you're trying out other effect settings and want to temporarily copy previously-edited MFX/TFX settings to another vacant effect slot.

- Select the effect that you want to copy.

You can copy from an insert effect by selecting IFX1–12.

If you copy from an insert effect, the result may not be exactly the same, due to differences in routing and level settings.

If you select MFX1 or MFX2, the **Return** level will be copied at the same time.

You can copy settings from a total effect by selecting TFX1 or TFX2.

If you check **All MFXs**, all master effect settings will be copied.

If you check **All TFXs**, all total effect settings will be copied. Master Volume settings will not be copied.

- In "To," specify the copy destination master effects or total effects.
- To execute the Copy Master/Total Effect command, press the OK button. To cancel, press the Cancel button.

## Swap MFX/TFX

Swap MFX/TFX is available on all of the MFX/TFX pages.

This command swaps (exchanges) settings between MFX1, MFX2, TFX1, and TFX2.

- Select "Swap MFX/TFX" to open the dialog box.

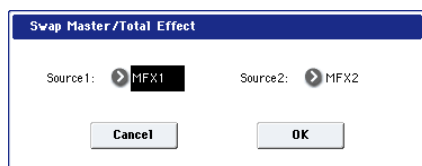

- Use "Source 1" and "Source 2" to select the master effect(s) or total effect(s) that you want to swap.
- To execute the Swap Master/Total Effect command, press the OK button. To cancel, press the Cancel button.

## Write FX Preset

Write FX Preset is available on all of the effects parameter editing pages, including IFX 1-12, MFX 1 and 2, and TFX 1 and 2.

- Select "Write FX Preset" to open the dialog box.

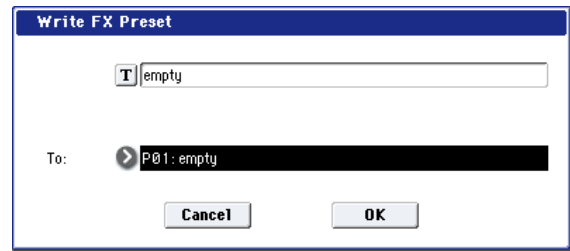

- Press the text edit button to open the text edit dialog box, and input a name for the effect preset.
- Use the "To" field to select the writing destination. We recommend that you use U00–U15.
- Press the OK button to write the user preset, or press the Cancel button if you decide to cancel.

*Note:* In Disk mode you can save or load effect preset settings on external media.

## Copy Drum Track

This command copies the Drum Track pattern and other settings from another Program, Combination, or Song. If you enable the "Program Settings too" checkbox, the Drum Program, volume, detune and EQ settings will also be copied.

## Erase Drum Track Pattern

This erases the specified drum track pattern. For more information, see "Erase Drum Track Pattern" on page 635.

## Remap MS/Sample Banks

This command lets you change the Sample and Multisample bank settings in Programs, Drum Kits, and Wave Sequences, either for the entire system, a selected Program/Wave Sequence/Drum Kit bank, or for a single Program, Drum Kit, or Wave Sequence. For instance, you can remap Programs which use **Smp: Old RAM** to play from a **User Sample Bank** instead.

It is available on any pages containing a sample/multisample bank select combo box, including HD-1 P2 Osc/Pitch Osc1 and Osc2 Basic, MOD-7 and STR-1 PCM Osc pages, and the Wave Sequence, Drum Kit, and Global Sample Management pages.

To remap the Multisample and Sample Banks:

- Select the Remap MS/Sample Bank command.

The Remap MS/Sample Bank dialog will appear.

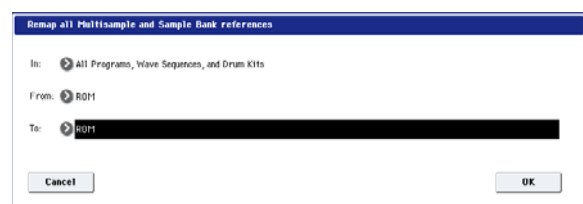

- Set the In parameter as desired.

If all of the loaded sounds use just this one KSC, select **All Programs, Wave Sequences, and Drum Kits**.

If one entire bank uses just this KSC, but other banks use different KSCs, select the bank to remap: **Bank I-A (Prog/Wseq/DKits)...Bank U-GG (Prog/Wseq/DKits)**. This will remap all Programs, Wave Sequences, and Drum Kits in the selected bank.

If sounds within a single bank use multiple KSCs, select the **Current Program** option. For instance, some users keep all sample-related Programs in Bank USER-G, but Program 000 uses Friday.KSC, Program 001 uses Saturday.KSC, and so on. The **Current Program** option lets you deal with each Program individually. There are similar commands for individual Wave Sequences and Drum Kits; the correct option will appear for the current mode.

 The Current Program option changes the edit buffer, and is not automatically saved. This lets you use COMPARE to revert to the original version, if desired. Make sure to Write the Program if you want to make the remap permanent. The All Programs etc. and Bank options changed the stored data directly, and do not require a separate Write command.

3. **Set the From parameter to the old Multisample and/or Sample bank—the one you'll be changing to the new bank.**

For instance, if you're updating sounds from **Smp: Old RAM** to a **User Sample Bank**, set From to **Smp: Old RAM**. Only Multisample/Sample banks which are currently loaded will appear in this list. If **In** is set to **Current**, only banks referred to by the current item will be shown.

4. **Set the To parameter to the new Multisample and/or Sample bank—the one that remapped references will be changed to.**
5. **Press the OK button to complete the remapping, or press the Cancel button to exit without making changes.**

If you press OK, a message appear to show how many bank references have been changed.

 Remapping does not affect Tone Adjust settings, including any settings in Combinations or Songs.

# Program mode: EXi

## EXi Program P0: Play

This is the main page of Program mode for EXi Programs. Among other things, you can:

- Select Programs
- Jump directly to the main editing pages
- Make basic edits to KARMA
- Set up the audio input s and resampling options
- Use the control surface

---

## EXi Common parameters

EXi, or Expansion Instruments, provide a wide variety of synthesis technologies. KRONOS includes eight EXi:

- AL-1 Analog Synthesizer
- CX-3 Tonewheel Organ
- STR-1 Plucked String.
- MS-20EX analog modeling synth
- PolysixEX analog modeling synth
- MOD-7 Waveshaping VPM synthesizer
- SGX-1 Premium Piano
- EP-1 MDS Electric Piano

You can combine any two EXi within an EXi Program. Each EXi has its own, very different parameters, which you can access via the EXi1 and EXi2 buttons at the bottom of the screen.

All EXi Programs also include a standard palette of capabilities, including effects, KARMA, key tracking, and the Common LFO and Common Step Sequencer. These standard parameters are available in the pages under the Common button, and are described in this chapter.

---

## Auto Song Setup

This feature copies the current Program or Combination into a Song, and then puts the KRONOS in record-ready mode.

If inspiration for a phrase or song strikes you while you're playing, you can use this function to start recording immediately. To do so:

1. **Hold down the ENTER key and press the SEQUENCER REC/WRITE key.**

The Setup to Record dialog box will open and ask "Are you sure?"

2. **Press OK.**

You will automatically enter Sequencer mode, and will be in the record-ready state.

3. **Press the START/STOP key to start the sequencer and begin recording.**

## 0-1: Main

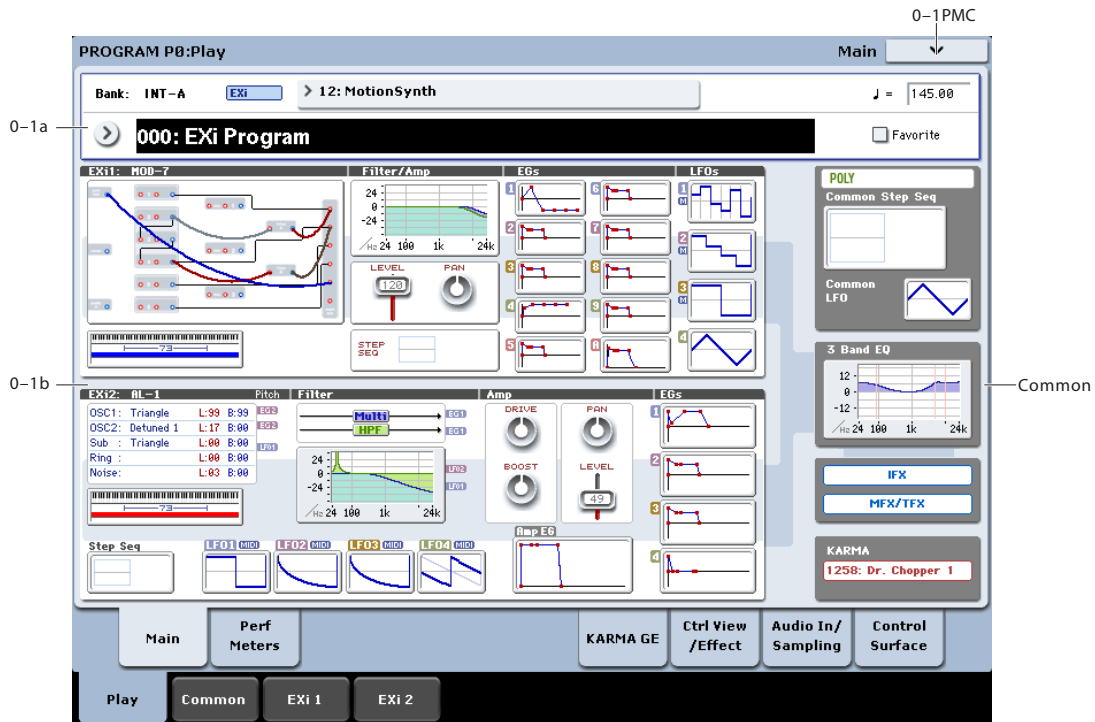

### 0-1a: Bank, Program, and Category Select

#### Bank [INT-A, USER-A...G and AA...GG]

This is the bank of the current Program. EXi Programs can be stored in bank INT-A, or in any of the USER banks, as long as their type is set to EXi. (For more information on setting the USER bank type, see “Changing the Bank Type for USER Banks” on page 3.)

You can select Banks either via the on-screen menu, or by using the front-panel Bank buttons.

#### Program Select [000...127, Name]

This is name and number of the current Program. When this parameter is selected, you can select Programs using the Inc  $\Delta$  and Dec  $\nabla$  buttons, numeric buttons 0-9, or the Value dial.

You can also use the pop-up Program and Category menus to select Programs from the LCD. For more details, please see “Program Select” on page 166

**Note:** On this page only, the VALUE slider functions as a modulation source - which means that you can't use it to select Programs.

#### Favorite [Off, On]

This button marks the Program as a “favorite,” which makes it easy to find in the Bank/Program Select and Category/Program Select dialogs.

Note that you must write the Program in order to save changes to this setting.

#### ♩ (Tempo) [040.00...300.00, EXT]

This is the tempo for the current Program, which applies to KARMA, tempo-synced LFOs, Step Sequencers, tempo-synced effects, and so on.

**EXT** means that the tempo will sync to external MIDI clocks. You'll see this if the Global MIDI page **MIDI Clock** parameter is set to **External MIDI**, or if it's set to **Auto** and the KRONOS is currently receiving MIDI clocks. For more information, please see “MIDI Clock (MIDI Clock Source)” on page 772.

**040.00...300.00** allow you to set a specific tempo in BPM, with 1/100 BPM accuracy. In addition to using the standard data entry controls, you can also just turn the TEMPO knob, or by playing a few quarter-notes on the TAP TEMPO button.

### 0-1b: Overview and Page Jump

This section shows an overview of the most important settings for the Program's two EXi instruments, along with some of the important Common parameters. The specific parameters will vary, depending on which EXi are being used. Parameters that you may see include oscillator settings, filter settings, EGs, LFOs, step sequencers, drawbar settings, and so on. See the individual EXi documentation for details.

The graphics give you a quick way to check all of these settings at a glance. They also let you jump instantly to any of the displayed parameters. Just touch one of the graphics, and you'll jump to the page containing its parameters. For instance, if you touch the Filter EG graphic, you'll go to the Filter EG page.

**Common**

The graphics along the right side of the screen show the most important Common parameters, which are shared by both EXi in the Program. This section will always show the same parameters, regardless of which EXi are being used.

**Common Voice Assign Mode**

This shows the voice assign mode of the Program—either POLY or MONO.

Press this area to jump to the Program Basic page.

**Common Step Sequencer**

This shows a graphic overview of the Common Step Sequencer.

Press the graphic to jump to the Common Step Sequencer page.

**Common LFO Graphic**

This shows the waveform of the Common LFO.

Press the graphic to jump to the Common LFO page.

**3 Band EQ Graphic**

This shows the mid-sweepable 3-band EQ.

Press this area to jump to the EQ page.

**IFX, MFX/TFX**

Press the IFX area to jump to the IFX Routing page.

Press the MFX/TFX area to jump to the MFX Routing page.

**KARMA GE Name**

This shows the name of the selected KARMA GE.

Press this area to jump to the GE Setup/Key Zones page.

**▼ 0–1: Page Menu Commands**

The number before each command shows its ENTER + number-key shortcut. For more information on these shortcuts, see “ENTER + 0-9: shortcuts for menu commands” on page 147.

- **0: Write Program.** For more information, see “Write Program” on page 147.
- **1: Exclusive Solo.** For more information, see “Exclusive Solo” on page 147.

**0–2: Performance Meters**

This page lets you look at the real-time performance of the KRONOS, including voice usage, voice stealing, and effects.

For more information, see “0–2: Performance Meters” on page 7.

**0–6: KARMA GE**

This page lets you make basic adjustments to KARMA. It works exactly like the similar page for HD-1 Programs; for more information, see “0–6: KARMA GE” on page 9.

For more detailed editing of KARMA parameters, see “Program P7: KARMA” on page 107.

**0–7: Controller View/Effects**

This page shows the functions assigned to the physical controllers, including the vector joystick, SW1 and 2, and knobs 5–8. It also includes an overview of all of the effects, and lets you adjust the Wet/Dry Balances separately for the IFX, MFX, and TFX.

It works exactly like the similar page for HD-1 Programs; for more information, see “0–7: Controller View/Effect” on page 13.

**0–8: Audio Input/Sampling**

This page lets you adjust the volume, pan, effects sends, and bussing for the analog, USB, and S/P DIF audio inputs. It also controls the sampling-related settings for Program mode.

It works exactly like the similar page for HD-1 Programs; for more information, see “0–8: Audio Input/Sampling” on page 14.

**0–9: Control Surface**

The Control Surface is the set of 9 sliders, 8 knobs, and 16 switches to the left of the LCD display. It looks like a mixer, but it can do other things as well, including editing sounds, controlling KARMA, and sending MIDI messages to external devices.

This page shows you the current values for each of the sliders, knobs, and buttons, along with information about what they are controlling. For instance, you can:

- Adjust the volume and pan for EXi instruments 1 and 2



- Control the Program's EQ settings and Master Effects Send levels
- Modulate sounds and effects using the Real Time Knobs
- Control KARMA, and select KARMA scenes, using the sliders and switches
- Edit sounds using Tone Adjust
- Assign sliders, knobs, and switches to different Tone Adjust parameters

Other than the exceptions noted below, it works almost exactly like the similar page for HD-1 Programs, substituting EXi 1/2 for OSC 1/2. For more information, see "0-9: Control Surface" on page 21.

are set to use the AL-1, they can still have separate Tone Adjust settings for their LFOs, oscillators, and so on.

---

### **0-9e: RT/KARMA (Real Time Knobs/KARMA)** AMSOURCE

Realtime Knobs 1-4 have dedicated functions: Cutoff, Resonance, Filter EG Intensity, and Filter Release. EXi instruments will support these functions as much as possible, depending upon their architecture.

For instance, the AL-1 and STR-1 support all of these controls. The CX-3, on the other hand, has no filters or EGs, and so it does not support them at all. For details on other EXi, please see their documentation.

---

### **0-9f: Tone Adjust**

The first group of Tone Adjust parameters are the Common set, which affect both EXi 1 and EXi 2 at the same time. This is convenient for making quick edits to the entire sound; for instance, you can use Filter Cutoff to make both EXi 1 and EXi 2 darker or brighter, or Filter/Amp EG Release Time to make their overall release times longer or shorter. For more details, and a complete list of the parameters, please see "Common Tone Adjust Parameters" on page 32.

Some EXi instruments may not support all of the Common Tone Adjust parameters. For details, please see the individual EXi manuals.

After the Common parameters, the items in the list will vary depending on the EXi being used. These EXi-specific parameters allow you to control settings unique to a given EXi, such as Oscillator 1 Morph in the AL-1, or Waveshaper Table selection in the MOD-7. For more information, please see:

"AL-1: Tone Adjust," on page 222.

"CX-3: Tone Adjust," on page 244.

"STR-1: Tone Adjust," on page 292.

"MS-20EX: Tone Adjust," on page 319.

"PolysixEX: Tone Adjust," on page 335.

"MOD-7: Tone Adjust" on page 385.

"SGX-1: Tone adjust" on page 393

"EP-1: Tone Adjust" on page 413

For these non-Common parameters, you have independent controls for both EXi 1 and EXi 2—even if they both use the same EXi. For instance, if both EXi

## EXi Program P4: Basic/Vector

These pages control the basic elements of the Program, along with the Vector synthesis features. For instance, you can:

- Select the EXi instruments which form the basis of the Program's sound

- Set up Vector fades between EXi 1 and EXi 2
- Set up Vector CCs to modulate Program and Effects parameters
- Program the Vector Envelope to move the Vector position automatically

### 4-1: Program Basic

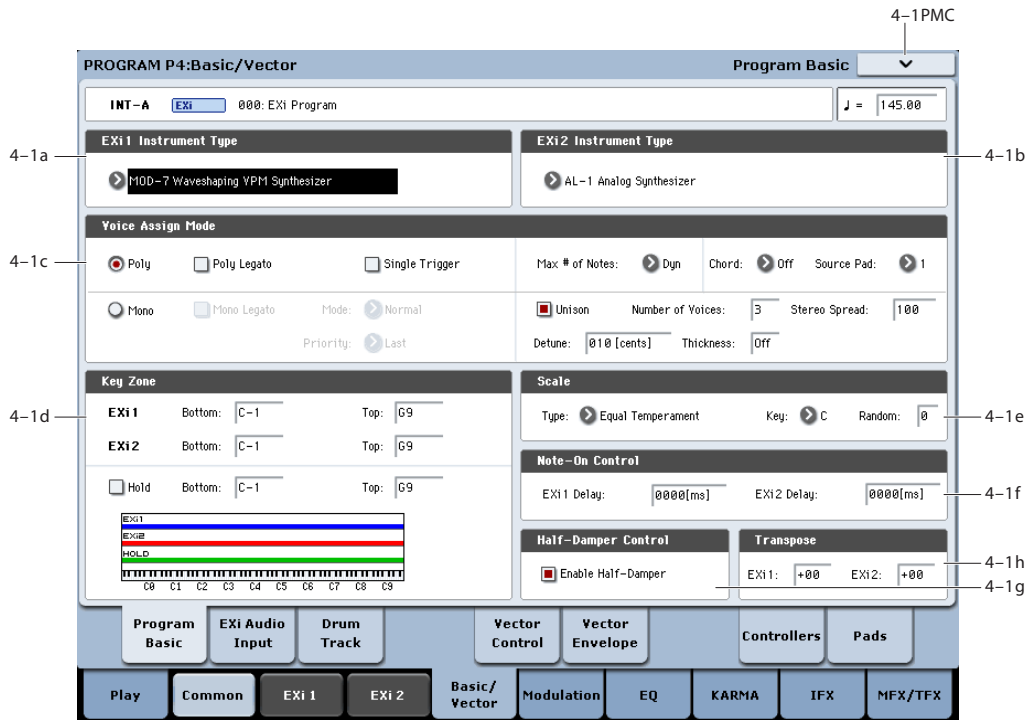

This page contains all of the basic settings for the Program. Among other things, you can:

- Select the EXi instruments which form the basis of the Program's sound
- Set the Program to play polyphonically or monophonically
- Create a keyboard split between EXi 1 and EXi 2
- Select the Program's scale

#### 4-1a: EXi 1

**EXi 1 Instrument Type** [AL-1, CX-3, STR-1, MS-20EX, PolysixEX, MOD-7, SGX-1, EP-1]

This is the most basic setting for the EXi Program. EXi instruments are complete synthesizers, in and of themselves; they may create or process sounds in completely different ways, and allow you to adjust completely different parameters.

For instance, the AL-1 is a virtual analog synthesizer, the CX-3 is a physically modeled tone-wheel organ, the MOD-7 is a patch-panel based VPM, Waveshaping, and sample-mangling synthesizer, and so on.

You can select either one or two EXi's for the Program. Unlike HD-1 Programs, there is no setting for Single or Double. If there are two EXi's, it doesn't matter which EXi is in which slot. You can even select only a single EXi, but place it in the second slot.

#### 4-1b: EXi 2

**EXi 2 Instrument Type** [List of EXi]

This is the second EXi slot for the Program.

#### 4-1c: Voice Assign Mode

**Voice Assign options may vary with different EXi**

As much as possible, the different EXi instruments support all of the voice assign options. However, there are cases in which a particular EXi does not support a specific voice assign parameter.

Additionally, when a Program uses two different EXi instruments, some of the voice assign options will only take affect if they are supported by both EXi. These include:

- The main Mode selection (Poly or Mono)
- Poly Legato
- Single Trigger

- Mono Legato
- Mono mode (Normal or Use Legato Offset)
- Unison

**[Voice Assign Mode] [Poly, Mono]**

These radio buttons select the basic voice allocation mode. Depending on which mode you select, various other options will appear, such as **Poly Legato (Poly mode only)** and **Unison (Mono mode only)**.

**Poly:** The program will play polyphonically, allowing you to play chords.

**Mono:** The program will play monophonically, producing only one note at a time.

**Poly**

**Poly Legato [Off, On]**

Poly Legato is available when the **Voice Assign Mode** is set to **Poly**. This option applies only to EXi which include sample playback.

Legato means to play notes so that they are smooth and connected; the next note is played before the last note is released. This is the opposite of playing detached.

**On (checked):** When you play with legato phrasing, only the first notes in the phrase (within the first 30ms) will use the normal Multisample Start Point, as set by the Start Point Offset parameter. The rest of the notes will use the Legato Start Point.

**Off (unchecked):** Notes will always use the setting of the Start Point Offset, regardless of whether you play legato or detached.

 With some Multisamples, Poly Legato may not have any effect.

**Single Trigger [Off, On]**

Single Trigger is available when the **Voice Assign Mode** is set to **Poly**.

**On (checked):** When you play the same note repeatedly, the previous note will be silenced before the next note is sounded, so that the two do not overlap.

**Off (unchecked):** When you play the same note repeatedly, the notes will overlap.

**Mono**

**Mono Legato [Off, On]**

This is available when the **Voice Assign Mode** is set to **Mono**.

Legato means to play notes so that they are smooth and connected; the next note is played before the last note is released. This is the opposite of playing detached.

When Mono Legato is On, the first note in a legato phrase will sound normally, and then subsequent notes will have a smoother sound, for more gentle transitions between the notes.

The **Mode** parameter, below, switches between two different Mono Legato effects, each of which achieves this smoothness in a different way. See the description of that parameter for more details.

**On (checked):** When you play with legato phrasing, the notes within a legato phrase will sound smoother, according to the setting of the **Mode** parameter, below.

**Off (unchecked):** Legato phrasing will produce the same sound as detached playing.

**Mode [Normal, Use Legato Offset]**

This parameter is available only when **Mono Legato** is On.

**Normal:** When you play legato, the envelopes and LFOs (and samples, if the EXi supports samples) will not be reset. Instead, only the pitch of the oscillator will change. This setting is particularly effective for wind instruments and analog synth sounds.

 When used with EXi which support samples, the pitch may occasionally be incorrect, depending on which multisample you play, and where on the keyboard you play.

**Use Legato Offset:** This applies only to EXi which support samples. When you play legato, all but the first note will use the Multisample's Legato Start Point, instead of the one set by the Start Offset parameter. This will be most effective for Multisamples with specifically designed Legato Offset points; for some Multisamples, it may have no effect.

Envelopes and LFOs will still be reset, as they are with detached playing.

**Priority [Low, High, Last]**

Priority is available when the **Voice Assign Mode** is set to **Mono**.

This parameter determines what happens when more than one note is being held down.

**Low:** The lowest note will sound. Many vintage, monophonic analog synths work this way

**High:** The highest note will sound.

**Last:** The most recently played note will sound.

**Max # of Notes**

**Max # of Notes [Dynamic, 1...16]**

**Dynamic** is the default. With this setting, you can play as many notes as the system allows.

**1-16** lets you limit the maximum number of notes played by the Program. You can use this to:

- Model the voice-leading of vintage synthesizers, such as the Polysix
- Control the resources required by individual Programs in Combination and Sequencer modes

**Max # of Notes** applies only when the main **Voice Assign Mode** is set to **Poly**. If **Mono** is selected, this is grayed out.

This setting does not limit the **Unison Number of Voices** parameter. For instance, if **Max # of Notes** is set to **6**, and **Unison Number of Voices** is set to **3**, you can play up to 6 notes, each with 3 Unison voices.

If there are two EXi in the Program, the **Max # of Notes** applies equally to both. For instance, if **Max # of Notes** is set to **4**, you can play up to 4 notes on each EXi.

## Chord

### Chord [Off, Bsc, Adv]

**Off** disables the Chord function.

**Bsc** (Basic) re-creates the chord mode of the Korg Polysix. Each time you play a new chord, it will cut off the previous chord. This option ignores the Voice Assign settings.

**Adv** (Advanced) uses the Program's Voice Assign settings, as if each note in the chord was a transposed set of oscillators layered within the Program.

Poly, Poly Legato, Single Trigger, Mono, Mono Legato, Legato Offset, Mono Priority, and Mono and Poly Unison all apply.

You can achieve the same effect as **Bsc**, above, by setting **Chord** to **Advanced**, **Voice Assign** to **Mono**, **Priority** to **Last Note**, and **Legato** to **Off**.

For more information, see "Using Chord mode" on page 36 of the Operation Guide.

### Source Pad [1...8]

Chord mode uses the chords assigned to the on-screen pads. This selects which of the pads to use. You can also choose chords using the pads themselves; for more information, see "Selecting chords" on page 38 of the Operation Guide.

## Unison

### Unison [On, Off]

Unison can be used in both **Mono** and **Poly** modes.

**On (checked):** When Unison is on, the Program uses two or more stacked, detuned voices to create a thick sound.

Use the **Number of Voices** and **Detune** parameters to set the number of voices and amount of detuning, and the **Thickness** parameter to control the character of the detuning.

**Off (unchecked):** The Program plays normally. If **Unison** is **Off**, then all of its associated parameters are grayed out.

### Number of voices [2...16]

This controls the number of detuned voices that will be played for each note when using **Unison**. It applies only when **Unison** is **On**.

### Stereo Spread [0...100]

**Stereo Spread** lets you create a wider stereo field when using **Unison**. It applies only when **Unison** is **On**.

This feature separates the different Unison voices into two groups. One group is panned to the left, and the other to the right. At **0**, both groups will be in the center; at **100**, the two groups will be hard-panned left and right, respectively; at intermediate values, they will be panned to intermediate left and right positions.

If there is an odd number of voices, one voice will be panned to the center.

If the voices are true stereo, **Stereo Spread** "steers" the stereo image of each voice, similar to MIDI Pan (CC#10) and the Control Surface Pan knobs. In this

case, intermediate settings of **Stereo Spread** may be the most effective, since they will still preserve some of the original stereo image.

Unison detuning is spread as evenly as possible across the left and right channels. The lowest voice will be on the left, and the highest on the right; the next-lowest on the left, and the next-highest on the right, etc., as below:

-14 cents: L

+14 cents: R

-10 cents: L

+10 cents: R etc.

Depending on the **Thickness** setting, the detuning may lean slightly to one side.

### Detune [00...200 cents]

Detune is available when **Unison** is **On**.

This parameter sets the tuning spread for the Unison voices, in cents (1/100 of a semitone). The **Thickness** parameter, below, controls how the voices are distributed across the detune amount. When **Thickness** is **Off**, the voices are distributed evenly, centered around the basic pitch.

For instance, let's say that the **Number of voices** parameter is set to **3**, **Detune** is set to **24**, and **Thickness** is **Off**:

Voice one will be detuned down by 12 cents, voice two will not be detuned, and voice three will be detuned up by 12 cents.

Voice	Detune
1	-12
2	0
3	+12

As another example, let's say that **Detune** is still set to **24** and **Thickness** is still **Off**, but **Number of voices** is set to **4**:

Voice one will still be detuned down by 12 cents, voice two will be detuned down by 4 cents, voice three will be detuned up by 4 cents, and voice 4 will be detuned up by 12 cents.

Voice	Detune
1	-12
2	-4
3	+4
4	+12

### Thickness [Off, 01...09]

Thickness is available when **Unison** is **On**.

This parameter controls the character of the detuning for the unison voices.

**Off:** Unison voices will be evenly distributed across the Detune range, as shown above.

**01-09:** Unison voices will be detuned in an asymmetric way, increasing the complexity of the detune, and changing the way in which the different pitches beat against one another. This creates an effect similar to vintage analog synthesizers, in which oscillators were frequently slightly out of tune. Higher numbers increase the effect.

---

#### 4-1d: Key Zone

You can create keyboard splits by setting top and bottom keys for EXi 1 and 2. Also, you can control the keyboard range over which the **Hold** parameter takes effect.

##### Setting Key Zones from the keyboard

In addition to using the standard data entry controls, you can also set all keyboard zones parameters directly from the keyboard. Just do the following:

1. **Select the key zone parameter you'd like to edit.**
2. **Press and hold the ENTER button.**
3. **Play a note on the keyboard to set the parameter.**
4. **Release the ENTER button.**

You can use this shortcut for all key and velocity parameters in the KRONOS.

##### **EXi 1 Bottom** [C-1...G9]

This sets the lowest key on which EXi 1 will play.

##### **EXi 1 Top** [C-1...G9]

This sets the highest key on which EXi 1 will play.

##### **EXi 2 Bottom** [C-1...G9]

This sets the lowest key on which EXi 2 will play.

##### **EXi 2 Top** [C-1...G9]

This sets the highest key on which EXi 2 will play.

##### **Hold** [On, Off]

Hold is like permanently pressing down on the sustain pedal. In other words, notes continue to sound as if you were holding down the key - even after you lift your fingers from the keyboard.

Unless the **Sustain Level** is set to 0 in Amp EG 1 (and Amp EG 2 in a Double Program), the sound will continue to play forever—or, for EXi which support samples, it will play for the entire length of the sample(s).

**On (checked):** The **Hold** function is enabled for the range set by the **Hold Bottom** and **Hold Top** parameters, below.

**Off (unchecked):** Notes will play normally. This is the default setting.

##### **Hold Bottom** [C-1...G9]

This sets the lowest key affected by the Hold function.

##### **Hold Top** [C-1...G9]

This sets the highest key affected by the Hold function.

---

#### 4-1e: Scale

##### **Type [Equal Temperament...User Octave Scale15]**

Selects the basic scale for the Program.

Note that for many of the scales, the setting of the **Key** parameter, below, is very important.

For a complete list of the available scales, please see “1-1g: Scale” on page 41.

##### **Key (Scale Key)** [C...B]

Selects the key of the specified scale.

This setting does not apply to the **Equal Temperament**, **Stretch**, and **User All Notes** scales.

 If you're using a scale other than Equal Temperament, the combination of the selected scale and the **Key** setting may skew the tuning of the note. For example, A above middle C might become 442 Hz, instead of the normal 440 Hz. You can use the Global Mode's **Master Tune** parameter to correct this, if necessary.

##### **Random** [0...7]

This parameter creates random variations in pitch for each note. At the default value of 0, pitch will be completely stable; higher values create more randomization.

This parameter is handy for simulating instruments that have natural pitch instabilities, such as analog synths, tape-mechanism organs or acoustic instruments.

---

#### 4-1f: Note-On Control

##### **EXi 1 Delay** [0ms...5000ms, KeyOff]

Use this to create a delay between the time that you press a key, and the time that EXi 1's note actually sounds.

This is most useful in Double Programs, for delaying one EXi in relation to the other.

**KeyOff** is a special setting. Instead of delaying the sound by a particular amount of time, the sound will play as soon as you release the key.

You can use this to create the “click” heard when a harpsichord note is released, for instance.

In general, when you use the **KeyOff** setting, it's also best to set the Amp EG **Sustain Level** to 0 (assuming the EXi includes an Amp EG).

##### **EXi 2 Delay** [0ms...5000ms, KeyOff]

This controls the note-on delay for EXi 2. For more information, see “EXi 1 Delay” on page 172.

---

#### 4-1g: Half-Damper Control

A half-damper pedal is a special type of continuous foot pedal, such as the Korg DS-1H. In comparison to a standard footswitch, half-damper pedals offer more subtle control of sustain, which can be especially useful for piano sounds.

The KRONOS will automatically sense when a half-damper is connected to the rear-panel DAMPER input. For proper operation, you will also need to calibrate the pedal, using the Calibrate Half-Damper command in the Global page menu.

The off and full-on positions of the half-damper work just like a standard footswitch. In conjunction with the **Enable Half-Damper** parameter, below, intermediate positions allow a graduated control of sustain, similar to the damper pedal of an acoustic piano.

### Enable Half-Damper [On, Off]

When this is **On** (checked), Half-Damper pedals, normal sustain pedals, and MIDI CC# 64 will all modulate the Amp EG, as described below.

When this is **Off** (un-checked), the pedals and MIDI CC#64 will still hold notes as usual, but will not modulate the Amp EG.

### Half-Damper Pedal and Release Time

The amount of modulation depends on whether the Amp EG **Sustain Level** is set to **0** (as is the case with most acoustic piano sounds), or set to **1** or more. The modulation is continuous, from 1x (no change) to 55 times longer; the table below shows a selection of representative points.

*Half-Damper modulation of Amp EG Release Time*

CC#64 Value	Multiply Amp EG Release Time by...	
	If Sustain = 0	If Sustain = 1 or more
0	1x	1x
32	2.1x	2.1x
64	3.2x	3.2x
80	5.9x	
96	22.3x	
127	55x	

## 4-1h: Transpose

These parameters make it easy to transpose one or both EXi. To keep the timbre the same for a given pitch, other key-related parameters are transposed as well, such as key tracking and note-number AMS.

For instance:

1. Set a key track break-point to C2.
2. Set the transpose to +2.

Now, the key track break-point will still display as C2, but will be transposed up to D2.

These transpositions are cumulative with Timbre/Track transpose in Combinations and Songs.

**Note:** The EXi 1/2 key zones directly represent the physical keyboard, and are not affected by these transpose settings. For more information, see “4-1d: Key Zone” on page 172.

### EXi 1 [-60...+60]

This transposes EXi1, in semitones. The default is 0.

### EXi 2 [-60...+60]

This transposes EXi1, in semitones. The default is 0.

## ▼ 4-1: Page Menu Commands

The number before each command shows its ENTER + number-key shortcut. For more information on these shortcuts, see “ENTER + 0-9: shortcuts for menu commands” on page 147.

- **0: Write Program.** For more information, see “Write Program” on page 147.
- **1: Exclusive Solo.** For more information, see “Exclusive Solo” on page 147.
- **2: Copy EXi Oscillator.** For more information, see “Copy EXi Oscillator” on page 181.



## 4-2: EXi Audio Input

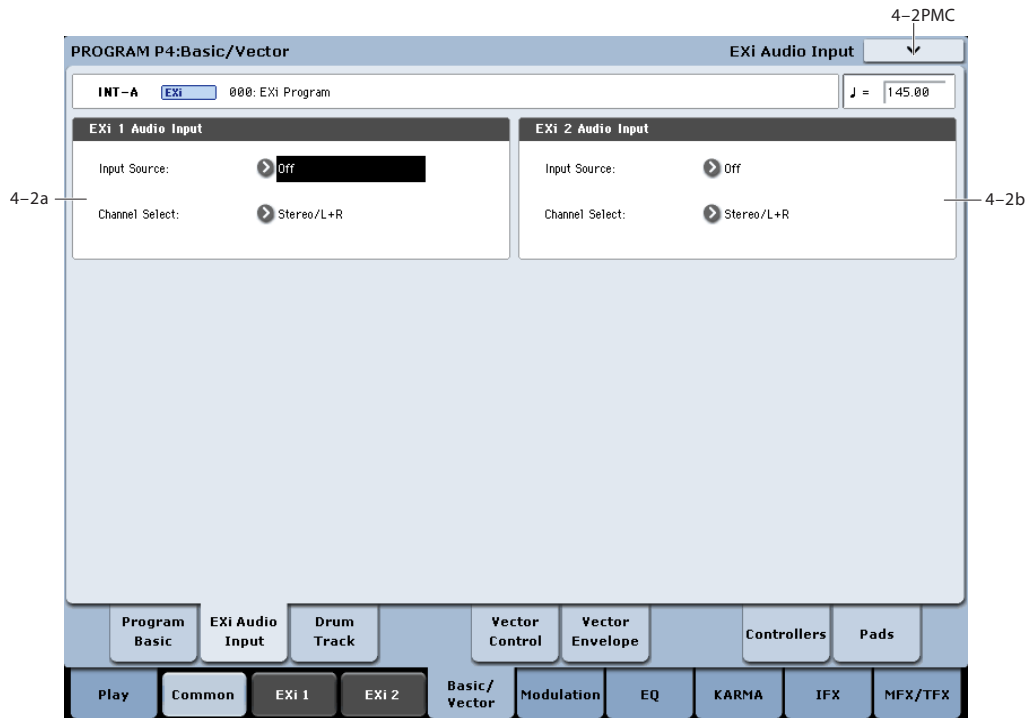

These parameters let you route audio into EXi instruments which support audio input, including the STR-1, MS-20EX, and MOD-7. You can use this to create feedback loops, or to process live or recorded audio through the EXi's synthesis engine.

EXi which do not support audio input will ignore these settings. The AL-1 supports audio input, but uses its own dedicated routing.

For more information on using audio inputs with EXi, see:

AL-1: "4-3c: Sub OSC/Audio Input" on page 191

STR-1: "4-8c: Feedback" on page 271

MS-20EX: "6-1k: EXTERNAL SIGNAL PROCESSOR (ESP)" on page 313

MOD-7: "5-1f: EXi Audio Input" on page 359

You can override these settings, if desired, in Combination and Sequencer modes. For more information, see "2-6: EXi Audio Input" on page 461 (Combi mode), and "2-6: EXi Audio Input" on page 573 (Sequencer mode).

### 4-2a: EXi 1

**Input Source** [PRG, Off, Audio Input 1/2, USB 1/2, S/P DIF Input L/R, L/R Output, Indiv. Output 1/2...3/4, REC 1/2...3/4, FX Control 1, 2, IFX 1...12, MFX 1, 2, TFX 1, 2]

This selects the input source for EXi1. You can use this to create a feedback loop, if desired.

**Off** disables the input.

**Audio Input 1/2, USB 1/2, and S/P DIF Input L/R** use the live audio from the selected input.

**L/R Output** and **Indiv. Output 1/2...3/4** use the audio as it is heard from the selected output (like connecting a cable from the output back to the input).

**REC 1/2...3/4** and **FX Control 1, 2** use the audio from the selected bus.

**IFX 1...12, MFX 1, 2, and TFX 1, 2** use the output of the selected effect.

**Channel Select** [Stereo/L+R, Left, Right]

**Stereo/L+R:** This selection routes a stereo signal to EXi with stereo inputs, and an L+R summation to EXi with mono inputs.

**Left, Right:** This uses only a mono signal from the selected channel.

### 4-2b: EXi 2

EXi 2 has the same controls as EXi 1, above.

---

## 4-3: Drum Track

This page works the same as the similar page in HD-1 Programs. For detailed information, see “1-3: Drum Track” on page 42.

---

## 4-5: Vector Control

Vector Synthesis lets you control Program and Effects parameters by moving the Vector Joystick, by using the programmable Vector Envelope, or by the combination of the two.

This page works exactly like the similar page for HD-1 Programs, substituting EXi 1/2 for OSC 1/2. For more information, see “1-5: Vector Control” on page 46.

---

### ▼ 4-5: Page Menu Commands

The number before each command shows its ENTER + number-key shortcut. For more information on these shortcuts, see “ENTER + 0-9: shortcuts for menu commands” on page 147.

- 0: **Write Program.** For more information, see “Write Program” on page 147.
  - 1: **Exclusive Solo.** For more information, see “Exclusive Solo” on page 147.
  - 2: **Copy EXi Oscillator.** For more information, see “Copy EXi Oscillator” on page 181.
- 

## 4-6: Vector Envelope

The Vector Envelope works together with the Vector Joystick to control the Vector position. It’s also special because it’s the only programmable modulation source which lets you modulate both Program and Effects parameters.

The Vector Envelope is different from the other envelopes in several ways:

- Each point has two “levels” - one for the X axis, and one for the Y axis.
- The envelope times can be based on seconds and milliseconds, or synced to tempo.
- Each point has a hold time, as well as a transition time to the next point.
- The envelope can loop between two points, for either a specified number of repeats, or as long as you hold the note.

This page works exactly like the similar page for HD-1 Programs, substituting EXi 1/2 for OSC 1/2. For more information, see “1-6: Vector Envelope” on page 50.

---

### ▼ 4-6: Page Menu Commands

The number before each command shows its ENTER + number-key shortcut. For more information on these shortcuts, see “ENTER + 0-9: shortcuts for menu commands” on page 147.

- 0: **Write Program.** For more information, see “Write Program” on page 147.
  - 1: **Exclusive Solo.** For more information, see “Exclusive Solo” on page 147.
  - 2: **Copy EXi Oscillator.** For more information, see “Copy EXi Oscillator” on page 181.
- 

## 4-8: Set Up Controllers

This page lets you set up the functionality of SW1/2 and Real-Time Knobs 5-8. It works exactly like the similar page for HD-1 Programs; for more information, see “1-8: Set Up Controllers” on page 53.

- 2: **Copy EXi Oscillator.** For more information, see “Copy EXi Oscillator” on page 181.

---

### ▼ 4-8: Page Menu Commands

The number before each command shows its ENTER + number-key shortcut. For more information on these shortcuts, see “ENTER + 0-9: shortcuts for menu commands” on page 147.

- 0: **Write Program.** For more information, see “Write Program” on page 147.
- 1: **Exclusive Solo.** For more information, see “Exclusive Solo” on page 147.

---

## 4–9: Pads

This page lets you view and edit the note assignments for the 8 on-screen pads. It works exactly like the similar page for HD-1 Programs; for more information, see “1–9: Pads” on page 54.

---

### ▼ 4–9: Page Menu Commands

The number before each command shows its ENTER + number-key shortcut. For more information on these shortcuts, see “ENTER + 0-9: shortcuts for menu commands” on page 147.

- 0: **Write Program**. For more information, see “Write Program” on page 147.
- 1: **Exclusive Solo**. For more information, see “Exclusive Solo” on page 147.
- 2: **Copy EXi Oscillator**. For more information, see “Copy EXi Oscillator” on page 181.
- 3: **Copy Pad Setup**. For more information, see “Copy Pad Setup” on page 154.

## EXi Program P5: Modulation

The entire Program shares several modulation sources, including:

- A single Common LFO, shared by all the voices - similar to the global LFO on some vintage analog synths
- A single Common Step sequencer, shared by all the voices

- Two Common Key Tracking generators, which are set up for the entire Program, but then calculated individually for each voice

These pages let you set up these Program-wide modulation sources.

### 5-1: Common Step Seq AMSource

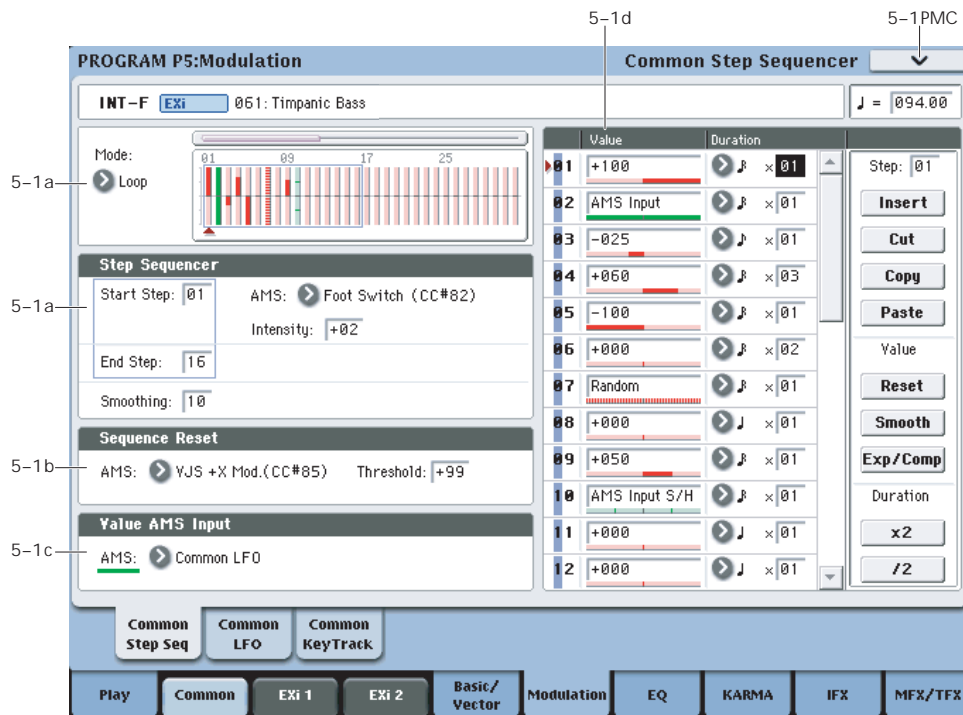

### Overview

The Common Step Sequencer creates complex, rhythmic patterns, which can then be used as an AMS source. For instance, you can modulate a filter to create sample-and-hold effects, modulate pitch to create melodic patterns, or modulate amplitude to create pulsing, triggered-gate effects.

The sequence can have up to 32 steps, each with its own level and duration. It can loop, or play only once. You can also:

- Re-start the Step Sequencer via AMS
- Modulate the Start Step via AMS
- Use individual steps to either gate or do sample-and-hold on a continuous AMS source, such as an LFO
- Assign individual steps to create a random level
- Use Smoothing to create gentle, curving shapes

### Differences from per-voice Step Sequencers

There is only a single Common Step Sequencer shared by the entire Program. It starts running as soon as you select the Program, and only resets when you tell it to

do so explicitly via the **Sequencer Reset** parameter. This is different from the per-voice Step Sequencer's **Key Sync Off** setting, which resets whenever all notes are released.

(However, you can create a similar behavior, if you like; see the **Sequencer Reset** parameter for more information.)

The Common Step Sequencer's persistence can be handy if you want to create a constant rhythm, and then play "underneath" that rhythm without re-triggering it. For instance, you can use a MIDI controller in your sequencer to reset the Common Step Sequencer every few bars, regardless of what notes are being played.

### Creating melodic patterns with the Step Sequencer

You can use the Step Sequencer to modulate synthesis parameters, such as filter cutoff- and you can also use it to create melodic patterns. To do so:

1. Assign the Step Sequencer as an AMS source for Pitch.
2. Set the AMS intensity to +25.

**3. In the Step Sequencer, set the step values as desired. Each increment of 4 equals a semitone.**

For example, to play an ascending chromatic scale, set the step values to 0, +4, +8, +12, +16, and so on. One octave up is +48, and two octaves up is +96.

## 5-1a: Step Sequencer

**Mode** [Loop, One Shot]

**Loop** makes the Step Sequence loop continuously between the **Start Step** and the **End Step**.

**One Shot** makes the Step Sequence play once from the **Start Step** to the **End Step**, and then hold at the **End Step**. You can still reset the Step Sequencer from AMS to make it play again.

**Start Step** [1...32]

This sets the step on which the sequence will start. The **Start Step** is important for the **Mode** parameter, above. You can also modulate it via AMS.

**AMS** [AMS Sources]

This selects an AMS source to modulate the **Start Step**. For a list of AMS sources, see "Alternate Modulation Source (AMS) List" on page 1091.

**Intensity** [-32...+32]

This controls the depth and direction of the **Start Step** modulation.

**End Step** [01...32]

This sets the last step in the sequence. Once the sequence reaches the **End Step**, it will either hold there until the note goes away (if **Mode** is set to **One Shot**), or loop back to the **Start Step** (if **Mode** is set to **Loop**).

### Smoothing

These controls filter the Step Sequencer's output signal, creating more gentle transitions between values. You can use this to round off the hard edges of the Step Sequencer's output, or to create envelope-like effects.

You have separate control of the amount of smoothing during the attack (when the signal is increasing) and decay (when it's decreasing).

**Attack** [00...99]

This controls the attack time of the smoother, or how long it takes to reach a new, *higher* value.

Higher **Attack** settings mean longer times.

Depending on how quickly the Step Sequencer value is changing, high **Attack** settings may mean that a new value is never quite reached.

**Decay** [00...99]

This controls the decay time of the smoother, or how long it takes the smoother to reach a new, *lower* value.

Higher **Decay** settings mean longer times.

### Using Smoothing to create envelope-like shapes

Since you have separate control over the attack and decay times, you can use Smoothing to create envelope-like pulses. To do so, you'll need to alternate **Step Values** so that a positive value is followed by a

value of zero. (You could use negative values, as well, but that would make the action of the **Attack** and **Decay** controls more complicated.)

To hear the effect clearly, let's use an AL-1, and assign the Step Sequencer to modulate Filter Cutoff:

1. In a single EXi Program, set EXi1 to AL-1.
2. Set the Filter Type to Lowpass, and the Routing to 24dB (4-pole).
3. Set the Filter Cutoff to 00.
4. On the Filter Mod page, set Filter A's AMS to Common Step Sequencer, and set the Intensity to 90.
5. In the Common Step Sequencer, set the End Step to 4.
6. Set the Mode to Loop.
7. Set Step 1's Value to +100.
8. For both Step 2 and Step 4, set the Value to 0.
9. Set Step 3's Value to +80.
10. Set the Durations of all four Steps to a 32nd-note.
11. Turn the front-panel Tempo knob to the center, at about 120 bpm.

If the tempo is really fast, you'd need to use longer Step Durations.

12. Set the Smoothing Attack to 0.

13. Adjust the Smoothing Decay to 80.

Now, the Step Sequencer will create a series of 16th-note pulses, like simple envelopes. With the settings above, they "envelopes" will have an instant attack, and a moderate decay/release time.

For more space between the pulses, try this:

14. For both Step 2 and Step 4, set the Duration "x" (Multiply Base Note by...) to 3.

This creates a series of 8th-note pulses, with a longer time between each pulse.

15. Adjust the Decay between 0 and 99, and listen to the difference that it makes.

You can also create smoother, LFO-like effects. Try this:

16. Set the Decay to 80, and then vary the Attack time.

With longer **Attack** times, the pulses become softer in character.

### Using Smoothing to make step transitions more gentle

Without smoothing, the Step Sequencer's output has very sharp transitions between values. Often, this may be just what you're looking for. In some cases, however, these transitions may cause audio artifacts, such as low-frequency bumps. This will depend on the parameter being modulated, and the intensity of the modulation.

If this happens, you can use smoothing to make the transitions more gentle, and reduce or eliminate the artifacts. To do so:

1. Adjust the smoothing until it's just high enough that the artifacts are no longer heard. Start with the Decay, and then use Attack if necessary.

When using positive Step Sequencer values and positive modulation, you'll generally only need to adjust the Decay; otherwise, you may need to adjust the Attack as well.

The trick is to set the smoothing high enough so that the artifacts go away, but low enough that the sound of the Step Sequencer isn't altered significantly.

---

## 5-1b: Sequencer Reset

### AMS [AMS Sources]

This selects an AMS source to reset the sequence to the **Start Step**.

To create an effect similar to the per-voice Step Sequencer's **Key Sync Off** setting, set this to **Gate 1+ Damper**.

### Threshold [-99...+99]

This sets the AMS level which will make the Step Sequencer reset. Among other things, you can use this to adjust the exact point in an LFO's phase at which the sequencer will be reset, effectively controlling its "groove" against other rhythmic effects.

When the threshold is **positive**, the Step Sequencer triggers when passing through the threshold moving upwards. When the threshold is **negative**, the Step Sequencer triggers when passing through the threshold moving downwards.

**Note:** with some LFO shapes, and with faster LFO speeds, the LFO may not always reach the extreme values of +99 or -99. In this case, setting the **Threshold** to these values may cause inconsistent behavior, or may mean that the Step Sequencer doesn't reset at all. If this happens, reduce the **Threshold** until the Step Sequencer triggers consistently.

---

## 5-1c: Value AMS Input

### AMS [AMS Sources]

This is the AMS source used for steps set to **AMS Input** or **AMS Input S/H**.

---

## 5-1d: Step Parameters

Each of the 32 steps has its own settings for Value and Duration.

### Value 1-32 [-100...+100, Random, AMS Input, AMS Input S/H]

-100 through +100 generate specific levels, just as you'd expect.

**Random** yields a different, random value every time the step is played.

**AMS Input** uses the signal from the **Value AMS Input** source, above. This can change continuously over the duration of the step. For instance, if you used an LFO as the **Value AMS Input**, you'd hear the LFO move over the duration of the step.

**AMS Input S/H** grabs the level of the **Value AMS Input** source at the start of the step, and then maintains that single value for the duration of the step.

### Duration (Base Note) 1-32 [♪...♩]

This sets the basic length of the step, relative to the system tempo. The values range from a 32nd note to a whole note, including triplets.

### x (Multiply Base Note by...) 1-32 [01...32]

This multiplies the length of the Base Note. For instance, if the Base Note is set to a sixteenth note, and Times is set to 3, the step's duration will be a dotted eighth note.

## Command buttons

### Step

### Step [01...32]

Selects the step that you want to edit.

### Insert

Inserts the cut or copied step at the current step.

### Cut

Cuts the current step. Subsequent steps will be moved forward. If desired, you can then paste or insert the cut step into another location.

### Copy

Copies the current step. You can then paste or insert the copied step into another location.

### Paste

Pastes the cut or copied step onto the current step, replacing it.

### Value

### Reset

Resets the "Value" of each step to 000.

### Smooth

Automatically adjusts the "Value" of each step so that they are smoothly connected.

### Exp/Comp

When you press the Exp/Comp button, the Step Sequence Value dialog box will appear. The value of each step will be expanded or compressed by the percentage (%) you specify.

*Step Sequence Value dialog box*

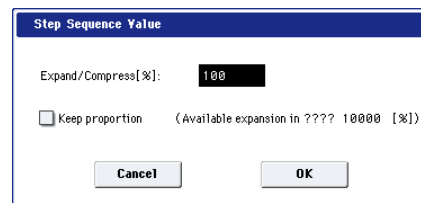

### Expand/Compress [%] [0...100]

If this is at 100%, the current value of each step will be used without change. If you check "Keep Proportion," the % value will be limited so that the expansion/compression will maintain the relationships between the current step settings.



## Duration

### x2

This doubles the duration of the steps or the “x (Multiply Base Note by...)” value. For example, it would turn eighth notes into quarter notes, and quarter notes into half notes.

### /2

This halves the duration of the steps or the “x (Multiply Base Note by...)” value. For example, it would turn quarter notes into eighth notes, and eighth notes into sixteenth notes.

---

## ▼ 5-1: Page Menu Commands

The number before each command shows its ENTER + number-key shortcut. For more information on these shortcuts, see “ENTER + 0-9: shortcuts for menu commands” on page 147.

- **0: Write Program.** For more information, see “Write Program” on page 147.
- **1: Exclusive Solo.** For more information, see “Exclusive Solo” on page 147.
- **2: Copy Step Sequencer.** For more information, see “Copy Step Sequencer” on page 181.

---

## 5-2: Common LFO AMSource

This is a single, free-running LFO, global for all voices in the Program—like the modulation LFOs in some vintage analog synths. It’s always available as a modulation source for both EXi1 and EXi2, regardless of which EXi instruments are being used.

This page works exactly like the similar page for HD-1 Programs. For more information, see “5-9: Common LFO” on page 96.

---

## 5-3: Common Keyboard Track

The Program includes two Common keyboard tracking generators, in addition to any keyboard tracking within the individual EXi instruments. You can use these Common keytracks as AMS sources for modulating most AMS destinations.

The Common Key Track parameters are shared by the entire Program, but the actual AMS values are calculated individually for each voice.

They work almost exactly like the Common Key Track generators for HD-1 Programs; for more information, see “6-9: Common Keyboard Track” on page 105.

There is one difference between the two, however: EXi keyboard tracking is affected by Portamento, so that it changes smoothly during glides.

---

## EXi Program P6: EQ

This page is very simple, but very useful: it lets you control the Program’s EQ settings. It works exactly like the similar page for HD-1 Programs; for more information, see “4-9: EQ” on page 90.

---

## EXi Program P7: KARMA

This pages let you control the Program’s KARMA settings. They work exactly like the similar pages for HD-1 Programs; for more information, see “Program P7: KARMA” on page 107.

---

## EXi Program P8: Insert Effect

This pages let you control the Program’s twelve Insert Effects (IFX). They work exactly like the similar pages for HD-1 Programs; for more information, see “Program P8: Insert Effect” on page 134.

---

## EXi Program P9: Master/Total Effect

This pages let you control the Program’s two Master Effects (MFX) and two Total Effects (TFX). They work exactly like the similar pages for HD-1 Programs; for more information, see “Program P9: Master/Total

Effect” on page 143.

## EXi Program: Page Menu Commands

### Copy EXi Oscillator

This command copies the oscillator settings of a EXi program.

1. Select “Copy EXi Oscillator” to open the dialog box.

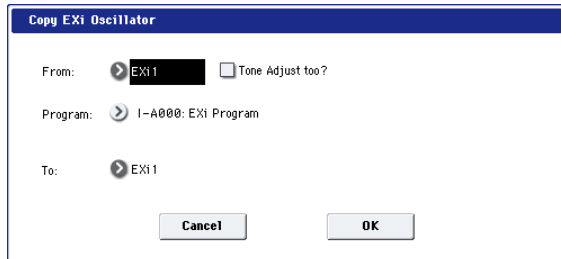

2. Use the “From” field to select whether to copy from EXi 1 or EXi 2.
3. Use the “Program” field to select the bank and number of the source Program. You can also use the BANK SELECT switches to select a bank.

*Note:* You can’t select HD-1 Programs here.

If “Tone Adjust too” is checked, the Tone Adjust settings will be copied along with the rest of the EXi parameters.

If this is not checked, and the destination (To) had previously used the same EXi Instrument Type as the source (From), then the Tone Adjust settings of the destination will be preserved.

If the EXi Instrument Types were different, all Tone Adjust settings of the destination will be initialized.

4. Use the “To” field to select the copy-destination oscillator.
5. Press the OK button to execute the Copy Oscillator operation, or press the Cancel button if you decide not to execute.

### Copy Step Sequencer

This command copies the step sequencer settings of the desired EXi program.

1. Select “Copy Step Sequencer” to open the dialog box.

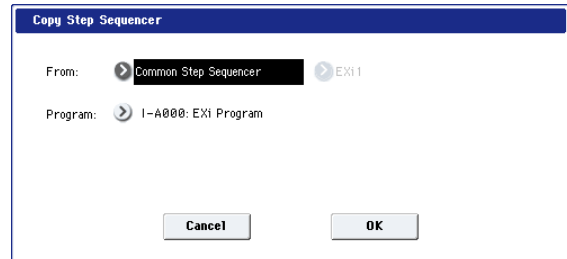

2. Use the “From” field to select either Common Step Sequencer or Voice Step Sequencer as the step sequencer you want to copy.

Voice Step Sequencer lets you copy from the per-voice step sequencer within an EXi, such as the AL-1. You can choose to copy from either EXi 1 or EXi 2. Some EXi, such as the CX-3, don’t have a per-voice step sequencer. Only EXi which actually contain per-voice step sequencers will appear in the EXi 1/2 selection.

3. Use the “Program” field to select the bank and number of the copy-source program.

You can also use the BANK SELECT switches to select a bank.

*Note:* You can’t select HD-1 programs.

4. Press the OK button to execute the Copy Step Sequencer command, or press the Cancel button if you decide not to execute.

#### Some AMS settings are not copied

The following AMS-related parameters are not copied:

- Start Step AMS and Intensity
- Sequence Reset AMS and Threshold
- Value AMS Input AMS selection



# EXi: AL-1 Analog Synthesizer

## AL-1 Overview

The AL-1 is Korg's most full-featured virtual analog synthesizer to date. It's played from within EXi Programs, so you can layer it with any other EXi—or layer two AL-1s together. Its features include:

- Two ultra-low-aliasing oscillators, based on new, proprietary technology
- Sub oscillator, colored noise generator, and live audio input; FM, sync, and ring modulation
- Dual multi-mode resonant filters, including Korg's new Multi Filter
- Drive and Low Boost, for adding per-voice grit, girth and distortion
- Four per-voice LFOs, five re-triggerable envelopes, and a per-voice step sequencer

- Two key tracking generators and two AMS mixers
- Up to 80 voices of polyphony
- Access to all standard EXi Program features, including the Common LFO, Common Step Sequencer, Key Track 1 & 2, KARMA, EQ, and effects

### Unsupported EXi Common parameters

The AL-1 supports all of the EXi Common parameters, except for two of the voice allocation options: **Poly Legato** and **Mono Mode** (Normal/Use Legato Offset). Both of these options are designed for sample playback, and so they don't apply to the AL-1.

All of the other voice allocation options are fully supported, including Mono, Mono Legato, Unison, etc.

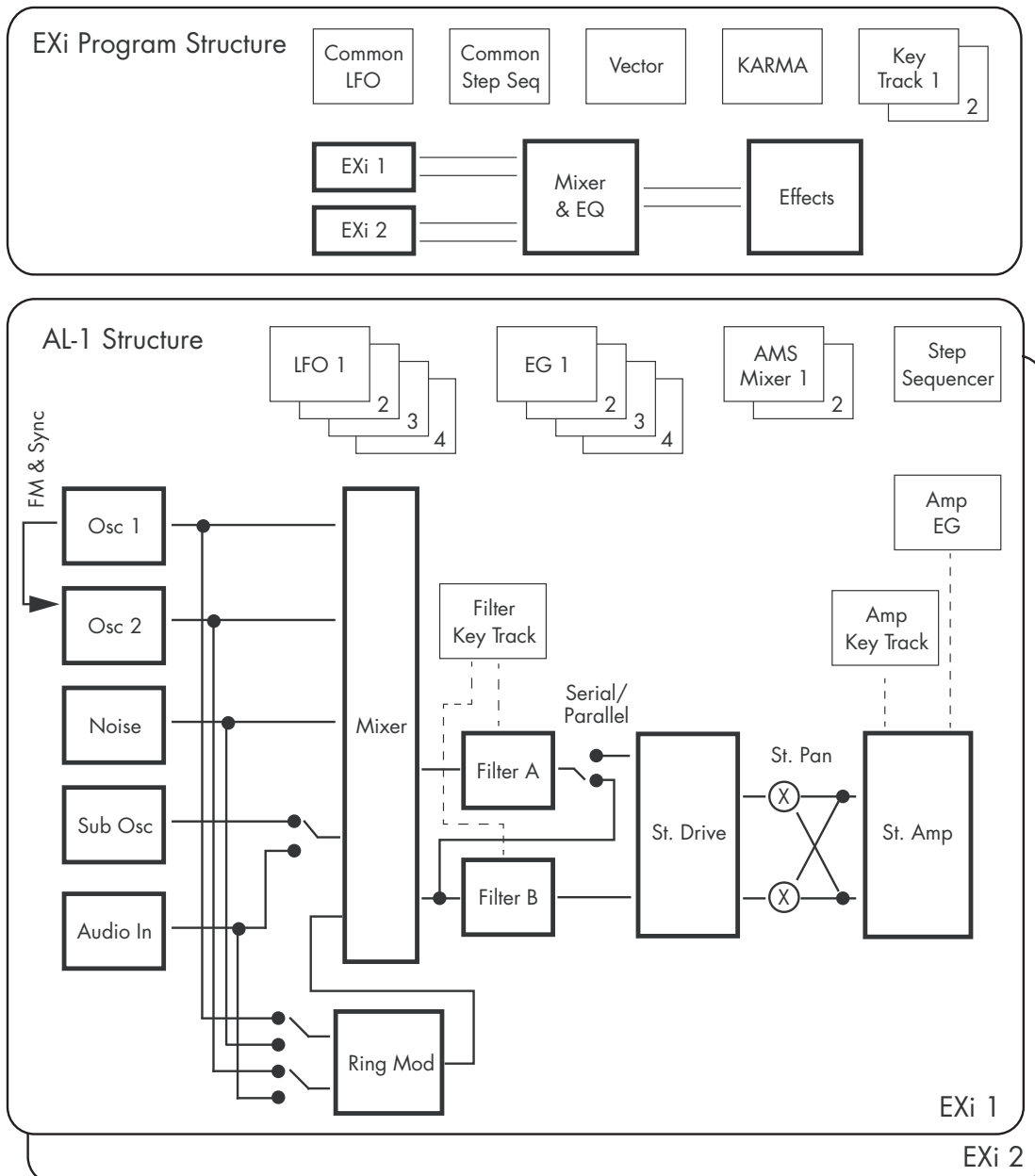

## EXi Program P0: Play

## 0-1: Main

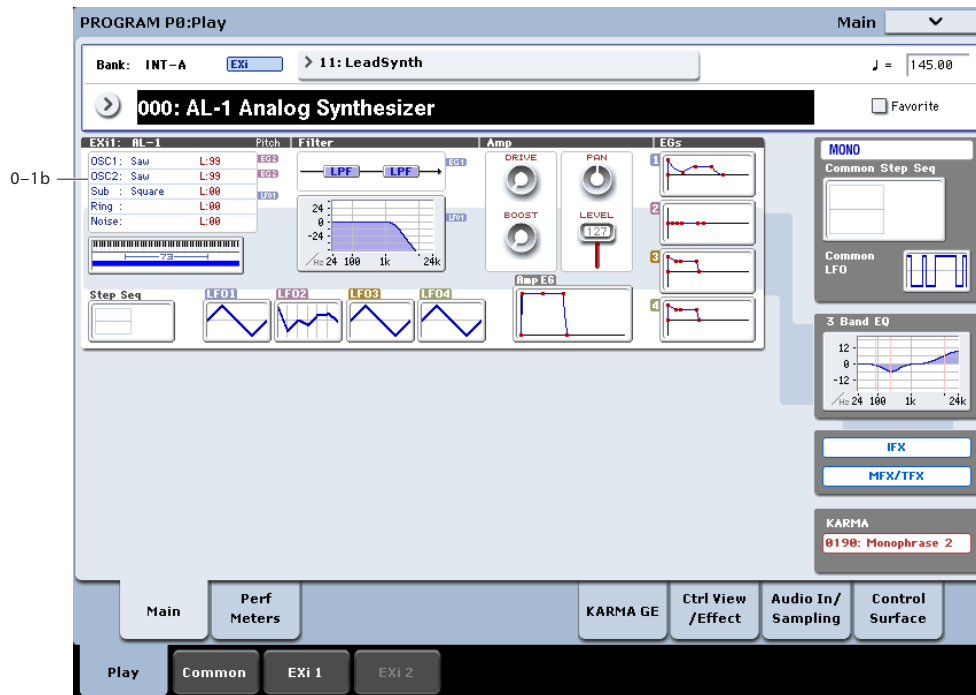

This is the main page of Program mode. For a full description of this page and all of its functions, please see “EXi Program P0: Play” on page 165. This section describes only the overview display, which differs for each individual EXi.

## 0-1b: Overview and Page Jump

This part of the page shows an overview of the most important settings for the Program’s two EXi instruments. The specific parameters will vary, depending on which EXi are being used. The specific parameters for the AL-1 are described below.

The graphics give you a quick way to check all of these settings at a glance. They also let you jump instantly to any of the displayed parameters. Just touch one of the graphics, and you’ll jump to the page containing its parameters. For instance, if you touch the Filter EG graphic, you’ll go to the Filter EG page.

*Tip:* Pressing EXIT several times will always bring you back to this page.

**Oscillators**

This shows the waveforms selected for OSC1, OSC2, and the Sub Oscillator. It also shows the level and balance settings for the three Oscillators, plus the Ring Modulator and Noise Generator. Levels are shown in red, and balance settings in green.

Press this area to jump to the OSC Basic page. For more information, see “4-1: OSC Basic” on page 186.

**Common Key Zone**

This shows the key zones for EXi1 and EXi2, as set on the Common section’s Program Basic page, in relation to the entire MIDI note range. The range of the 61-, 73-, or 88-note keyboard is also shown, as appropriate.

Press this area to jump to the Program Basic page.

**Pitch**

This shows the Pitch EG Select and Pitch LFO Select settings for OSC1 and OSC2.

Touch an EG icon to jump to the Pitch EG/Mod page, or touch an LFO icon to jump to the Pitch Common page.

**Filter****Filter Routing, Type, and Frequency Graphic**

This shows the filter routing, filter type(s), and a graphic representation of the filter frequency response, including cutoff and resonance.

Press this area to jump to the Filter Basic page.

**Amp****Driver, Low Boost, Pan, Amp Level**

This shows the Amp section’s **Driver**, **Low Boost**, **Pan**, and **Amp Level** values.

If the Driver section’s **Bypass** is on, **Driver** and **Low Boost** are not shown.

Press this area to jump to the Amp/Driver page.

## ***EGs, LFOs, and Step Sequencer***

### **Step Sequencer Graphic**

This shows a graphic overview of the per-voice step sequencer.

Press this area to jump to the Step Sequencer page.

### **EG 1...4, Amp EG Graphics**

These show the shapes of the five EGs. Touch any of them to jump directly to the corresponding edit page.

### **LFO 1, 2, 3, 4 Graphic**

These show the waveforms and shapes of the four LFOs. Touch any of them to jump directly to the corresponding edit page.

### **Common**

The graphics along the right side of the screen show the most important Common parameters, which are shared by both EXi in the Program. This section will always show the same parameters, regardless of which EXi are being used.

### **Common Voice Assign Mode**

This shows the voice assign mode of the Program—either POLY or MONO.

Press this area to jump to the Program Basic page.

### **Common Step Sequencer**

This shows a graphic overview of the Common Step Sequencer.

Press this area to jump to the Common Step Sequencer page.

### **Common LFO Graphic**

This shows the waveform of the Common LFO.

Press this area to jump to the Common LFO page.

### **3 Band EQ Graphic**

This shows the mid-sweepable 3-band EQ.

Press this area to jump to the EQ page.

### **IFX, MFX/TFX**

Press the IFX area to jump to the IFX Routing page.

Press the MFX/TFX area to jump to the MFX Routing page.

### **KARMA GE Name**

This shows the name of the selected KARMA GE.

Press this area to jump to the GE Setup/Key Zones page.

## Program P4: OSC Pitch

These pages control the most basic elements of AL-1's sounds: the waveforms that the oscillators play, and the pitch at which it plays them. For instance, you can:

- Select the waveforms for Oscillator 1, Oscillator 2, and the Sub-Oscillator.

- Set the basic pitch of the sound, including the octave, fine tuning, and so on.
- Control pitch modulation from a wide variety of sources, such as JSX, the ribbon, LFOs, and EGs.

### 4-1: OSC Basic

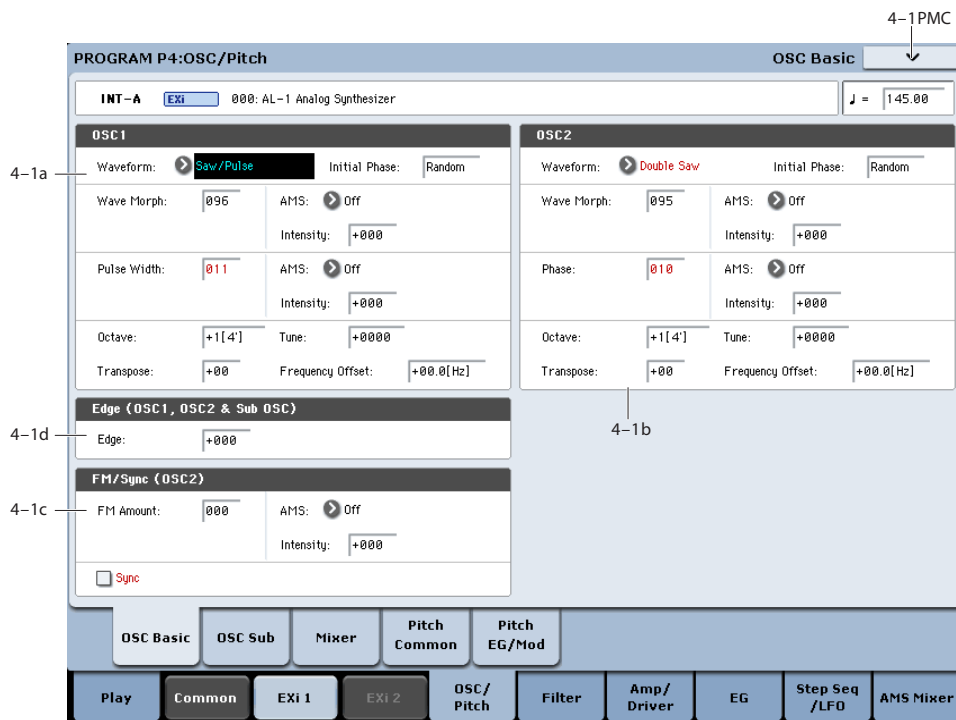

### Modeling vintage analog synths

KRONOS and the AL-1 provide a range of features for modeling vintage analog synths. Instead of simply providing fixed presets to choose between, there are separate parameters for individual synth characteristics—which means that you can mix and match as desired, for an even broader timbral palette.

For more information on modeling specific aspects of vintage synths, see the references below.

- Oscillator timbre: see “Edge” on page 188
- Oscillator pitch: see “Randomizing frequency for an analog feel” on page 188
- Unison pitch: see “Thickness” on page 171
- Oscillator interaction: see “Initial Phase” on page 187
- Basic filter characteristics: see “Filter Routing” on page 197
- Filter timbre: see “Resonance Bass” on page 198
- Monophonic voice assignment: see “Priority” on page 170
- Portamento: see “Mode” on page 193

### 4-1a: Oscillator 1

#### Waveform

**Waveform** [Saw, Pulse, Saw/Pulse, Double Saw, Detuned Saw 1, Detuned Saw 2, Triangle, Square/Triangle]

This selects the waveform for Oscillator 1, and will also affect the behavior of the **Wave Morph** and **Pulse Width/Phase/Detune** parameters, below.

**Saw** produces a sawtooth wave—the traditional buzzy analog synth sound.

**Pulse** produces a square wave with variable pulse width, as controlled by the **Pulse Width** parameter below.

**Saw/Pulse** creates both of the waveforms at the same time. You can crossfade between the two using the **Wave Morph** parameter, below.

**Double Saw** produces two sawtooth waveforms simultaneously. You can adjust the phase of the second sawtooth using the aptly-named **Phase** parameter, below, and adjust its volume with the **Wave Morph** parameter.



**Detuned Saw 1** produces two detuned sawtooth waveforms simultaneously. **Detune** controls the amount of detuning, and **Wave Morph** adjusts the volume of the second sawtooth.

**Detuned Saw 2** is similar to **Detuned Saw 1**, except that the second sawtooth is 180 degrees out of phase. This produces a timbre similar to pulse width modulation, with the **Detune** parameter controlling both detune and the speed of the PWM effect.

**Triangle** produces a pure tone with relatively few overtones.

**Square/Triangle** simultaneously creates a square wave (in which the pulse width is fixed at 50%) and a triangle wave. **Wave Morph** crossfades between the two.

**Initial Phase [-180...+180, Random]**

This controls the initial phase of Oscillator 1, in 1-degree increments.

**Random:** with each note-on, the waveform will start from a random point along the waveform, to simulate the varying phase relationships between oscillators in analog synthesizers.

**Wave Morph [000...100]**

The function of this parameter changes depending on the **Waveform** selection, above.

When **Waveform** is set to either **Saw/Pulse** or **Square/Triangle**, **Wave Morph** crossfades between the two waveforms. At 0, you'll hear only the first waveform; at 100, you'll hear only the second waveform; and at 50, you'll hear an equal mix of both.

When **Waveform** is set to **Double Saw**, **Detuned Saw 1**, or **Detuned Saw 2**, **Wave Morph** controls the volume of the second Sawtooth wave.

**Wave Morph** is not available when the **Waveform** is set to Saw, Pulse, or Triangle.

**AMS [List of AMS Sources]**

This selects an AMS source to control **Wave Morph**. For a list of AMS sources, see "Alternate Modulation Source (AMS) List" on page 1091.

**AMS Intensity [-100...+100]**

This controls the depth and direction of the AMS modulation for **Wave Morph**.

**Pulse Width/Phase/Detune [000...100]**

The name and function of this parameter changes depending on the **Waveform** selection, above.

When the **Waveform** is set to Pulse or Saw/Pulse, this is named **Pulse Width**, and controls the width of the Pulse waveform. For details, see "More on Pulse Width," below.

When **Waveform** is set to **Double Saw**, it is named **Phase**, and controls the phase relationship between the two Sawtooth waves.

When **Waveform** is set to **Detuned Saw 1** or **2**, this is named **Detune**, and controls the detune amount between the two Saws. The adjustments are in half-cent increments, so that 0 = 0 cents, 50 = 25 cents, and 100 = 50 cents. Saw 1 is tuned up, and Saw 2 is tuned down, so that the tonal center is maintained.

**More on Pulse Width**

Pulse waveforms are simple, rectangular shapes. The Pulse Width sets the percentage of the waveform spent in the "up" position. A few examples are shown in the diagram below. Note that a square wave is just a pulse wave with the width set to 50%.

The width controls the timbre of the oscillator, from pure and hollow at 50% (a square wave) to thin and reedy at the extremes.

At settings of 0 and 100—or when the Pulse Width is modulated to these values via AMS—the Pulse wave will be silent, since these eliminate the "pulse" altogether.

*Pulse waveform at different widths*

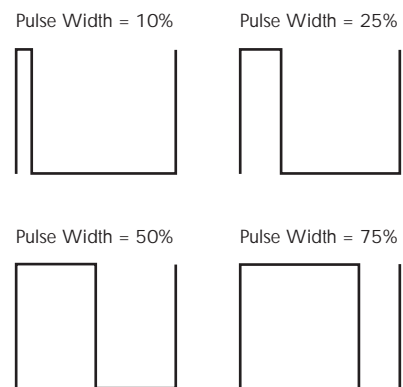

The real magic of the pulse wave comes when you modulate the width, using the AMS source and intensity below. Try using a medium-speed triangle LFO, or a sweeping EG.

**AMS [List of AMS Sources]**

This selects an AMS source to control **Pulse Width/Phase/Detune**. For a list of AMS sources, see "Alternate Modulation Source (AMS) List" on page 1091.

**AMS Intensity [-100...+100]**

This controls the depth and direction of the AMS modulation for **Width/Phase/Detune**.

*Waveform Type and Modulatable Parameters*

Waveform Type	Morph	Pulse Width/Phase/Detune
Saw	n/a	n/a
Pulse	n/a	Pulse Width
Saw/Pulse	Xfade between saw and pulse	Pulse Width
Double Saw	Volume of 2nd saw	Phase
Detuned Saw 1	Volume of 2nd saw	Detune
Detuned Saw 2	Volume of 2nd saw	Detune and PWM effect
Triangle	n/a	n/a
Square/Triangle	Xfade between square & triangle	n/a

## Frequency

Note: The Sub-Oscillator's frequency is always exactly one octave below that of Oscillator 1. This means that adjusting any of the controls in this section, including **Octave**, **Transpose**, **Tune**, and **Frequency Offset**, will affect the Sub-Oscillator as well as Oscillator 1.

**Octave** [-2[32'], -1[16'], +0[8'], +1[4'], +2[2']]

This sets the basic pitch of Oscillator 1, in octaves. The default is +0[8'].

**Transpose** [-12...+12]

This adjusts the pitch in semitones, over a range of  $\pm 1$  octave.

**Tune** [-1200...+1200]

This adjusts the pitch in cents, over a range of  $\pm 1$  octave. A cent is 1/100 of a semitone.

**Frequency Offset** [-10.0Hz ... +10.0Hz]

This adjusts the pitch by increments of 0.1 Hz.

**Frequency Offset** is different from **Tune** in that, when used to detune the two oscillators, it can create a constant beat frequency across the range of the keyboard.

## Randomizing frequency for an analog feel

You can use various methods to randomize the oscillator frequency, in order to simulate the instability of analog oscillators:

- Simulate analog drift by modulating pitch with one of the **Continuous Random** LFO waveforms.
- Use **Tune** or **Frequency Offset** to detune the oscillators a tiny bit.
- Set the **Scale Random** parameter (in the Common section, Basic/Vector page, EXi Basic tab) to 1, 2, or 3 to create small amounts of random pitch variation at note-on.

## 4-1b: Oscillator 2

Oscillator 2 is very similar to Oscillator 1, as described above. The only differences are:

- Oscillator 2 does not include the **Triangle** or **Square/Triangle** waveforms.
- Oscillator 2's pitch does not affect the Sub-Oscillator.
- When Sync is enabled, Oscillator 2's **Initial Phase** setting affects only the very beginning of the sound, before Oscillator 1 completes its first cycle. After that, Oscillator 2's phase is controlled by Oscillator 1.

## 4-1c: FM/Sync

**FM Amount** [000...100]

Oscillator 1 is the modulator, and Oscillator 2 is the carrier. In other words, FM affects the timbre of Oscillator 2, and does not affect the timbre of Oscillator 1.

You can create stable, periodic waveforms by setting **FM Amount** to any multiple of 6, such as 6, 12, 18, 24, etc. At other settings, the signal will "roll around" in interesting ways.

This feature is similar to a classic five-voice analog synthesizer's "Osc B to Freq A" function, except that the depth can be up to eight times greater—16 octaves instead of 2.

To create a cool sync-like sound with FM:

1. Set Oscillator 1's Waveform to Pulse.
2. Assign an AMS source, such as an EG or LFO, to modulate Oscillator 1's Pulse Width.
3. Set Oscillator 2's Waveform to Pulse.
4. Set Oscillator 2's Pulse Width to 50.
5. Set the FM amount to 24.

Note also that FM, Sync, and Ring Mod can all be used simultaneously.

**AMS** [List of AMS Sources]

This selects an AMS source to control the **FM Amount**. For a list of AMS sources, see "Alternate Modulation Source (AMS) List" on page 1091.

**Intensity** [-100...+100]

This controls the depth and direction of the **FM Amount** AMS modulation.

**Sync** [Off, On]

When **Sync** is **On**, Oscillator 1 controls the pitch of Oscillator 2, and changing or modulating Oscillator 2's frequency changes its timbre, instead of its pitch.

Every time that Oscillator 1 begins a new cycle (the instant that it passes through zero going from negative to positive), Oscillator 2 snaps back to the start of its waveform.

Note that FM, Sync, and Ring Mod can all be used simultaneously.

To create the classic sync sweep sound:

1. Turn Sync On.
2. Assign an EG as the AMS source for Oscillator 2 Pitch.
3. Now, the EG is controlling the sync sound.
4. Set the EG and Pitch AMS Intensity parameters to create the desired sync sweep.

## 4-1d: Edge (OSC 1, OSC 2 & Sub OSC)

**Edge** [-100...+100]

This controls the high-frequency character of Oscillator 1, Oscillator 2, and the Sub Oscillator.

Set it to 0 for a timbre similar to vintage American analog synths, and to higher values for "edgier" tones.

Negative values result in warmer, darker tones, to create an oscillator timbre similar to the MS-20.

### ▼ 4-1: Page Menu Commands

The number before each command shows its ENTER + number-key shortcut. For more information on these shortcuts, see “ENTER + 0-9: shortcuts for menu commands” on page 147.

- 0: **Write Program**. For more information, see “Write Program” on page 147.
- 1: **Exclusive Solo**. For more information, see “Exclusive Solo” on page 147.

## 4-2: Sub/Noise/Ring Mod

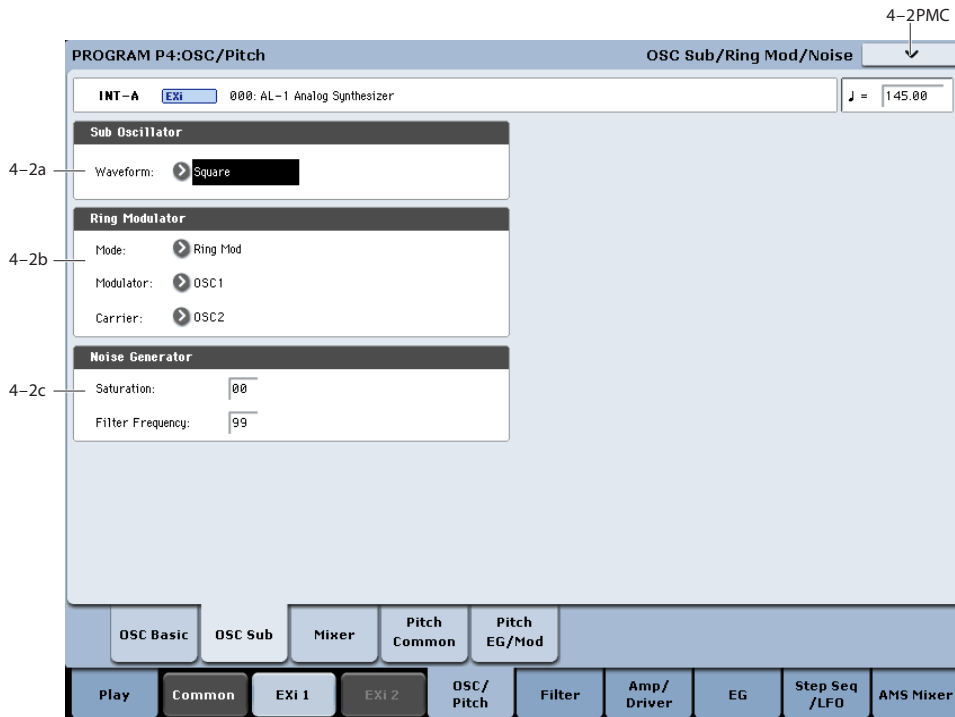

### 4-2a: Sub Oscillator

The Sub Oscillator plays exactly one octave below Oscillator 1. All Oscillator 1 pitch mod effects the Sub Oscillator as well.

#### Waveform [Square, Triangle]

This selects the basic waveform of the Sub-Oscillator. The **Triangle** waveform’s amplitude is three times that of the square, to compensate for the difference in perceived loudness. This means that similar Level settings at the mixer result in similar amounts of “boom.”

Note that this is different from Oscillator 1’s **Triangle** wave. In Oscillator 1, the **Triangle** amplitude is the same as that of the other waveforms, resulting in a lower perceived volume (just like on classic analog synths).

### 4-2b: Ring Modulator

The Ring Modulator has its own input to the Mixer section. The default volume is 0, so to hear it, you’ll need to turn it up!

When the frequencies of the **Carrier** and the **Modulator** are the same, the Ring Modulator produces steady, constant waveforms. When the two are detuned, it produces more movement and overtones.

Note that FM, Sync, and Ring Mod can all be used simultaneously.

- ⚠ Even though the oscillators themselves have extremely low aliasing, Ring Mod can produce aliasing - especially at higher frequencies.

#### Mode [Ring Mod, AM, Rectify, Clip]

This selects between four different variations of ring modulation.

**Ring Mod** produces the traditional ring modulation effect.

**AM** includes both the traditional ring modulation effect and the dry signal of the Carrier input.

**Rectify** means that any negative parts of the Modulator’s waveform are flipped around to be positive instead. If the **Modulator** is a square wave, this mode sounds pretty much like just listening to the **Carrier** alone.

**Clipped** means that the Modulator input is clipped to positive values before going into the Ring Mod; any negative parts of the waveform are chopped off and thrown away.

#### Modulator [OSC 1, Noise]

This selects the modulator source for the Ring Modulator. **Rectify** and **Clip**, above, both affect the **Modulator** signal.

**Carrier [OSC 2, Ext Input]**

Selects the carrier source for the ring modulator.

**Ext Input** uses the audio input selected under Sub OSC/Audio Input, on the Mixer page. For more information, see “4–3c: Sub OSC/Audio Input” on page 191.

**4–2c: Noise Generator**

The noise generator includes **Saturation**, for creating unique and chaotic noise effects, and a dedicated 1-pole filter to control noise color.

For standard white noise, set the **Saturation** to 0, and the **Filter Frequency** to 99.

For colored noise (such as pink noise), set the **Saturation** to 0, and reduce the **Filter Frequency** as desired.

To create “speckled noise” such as rocket sounds and thunder, set **Saturation** to 99, and **Filter Frequency** to 10.

To create key contact noise (such as you might find on vintage analog synths), create speckled noise as described above, and then use a fast EG to control its volume in the mixer.

**Saturation [0...99]**

This control clips the noise signal, for added crunch. Subtle variations in saturation are more noticeable with very low **Filter Frequency** settings (see below), allowing you to create organic, rumbling timbres.

**Filter Frequency [0...99]**

This is a simple, 1-pole lowpass filter for controlling the “color” of the noise.

**▼ 4–2: Page Menu Commands**

The number before each command shows its ENTER + number-key shortcut. For more information on these shortcuts, see “ENTER + 0-9: shortcuts for menu commands” on page 147.

- **0: Write Program.** For more information, see “Write Program” on page 147.
- **1: Exclusive Solo.** For more information, see “Exclusive Solo” on page 147.

**4–3: Mixer**

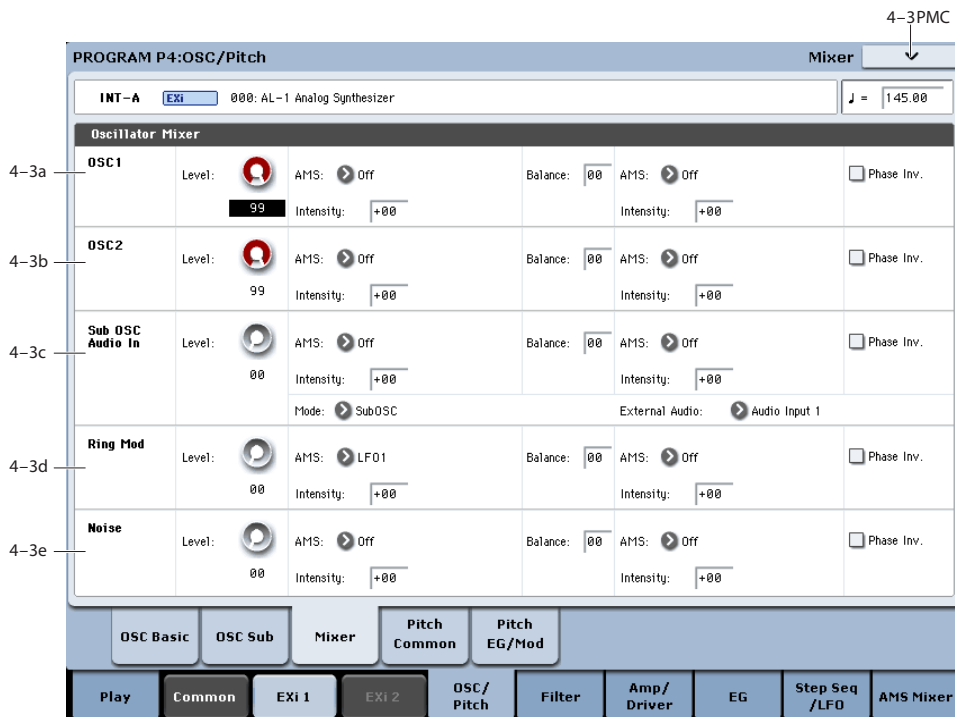

The Mixer page controls the volume levels for the five main parts of the Oscillator, and also controls the routing to the filter section. For instance, you can:

- Control the volume levels for Oscillator 1, Oscillator 2, the Sub Oscillator (or an Audio Input), the Ring Modulator, and the Noise Generator.
- Modulate these volume levels via AMS.
- When the **Filter Routing** is set to either **Serial** or **Parallel**, you can route each of the five Oscillator

elements through Filter A, Filter B, or a combination of the two - and then modulate that routing via AMS.

- Select an audio input to route through the filters, driver, ring modulator, and effects.

### 4-3a: Oscillator 1

**Level** [0...99]

This controls the volume level for Oscillator 1.

**AMS** [List of AMS Sources]

This selects an AMS source to control the **Oscillator 1 Level**. For a list of AMS sources, see "Alternate Modulation Source (AMS) List" on page 1091.

**Intensity** [-99...+99]

This controls the depth and direction of the **Oscillator 1 Level** AMS modulation.

**Balance** [0...99]

This controls the filter routing for Oscillator 1. It applies only when the **Filter Routing** is set to either **Serial** or **Parallel**; otherwise, it is grayed out.

0 is the default, and means that Oscillator 1 goes into Filter A. If the **Filter Routing** is set to **Serial**, it will also pass through Filter B.

99 means that Oscillator 1 goes into Filter B.

In between, the oscillator will go to a combination of both filters. By modulating the **Balance** via AMS, you can crossfade between routing through Filter A and Filter B. For more information, see "Interaction between the filters and the mixer," on page 196.

**AMS** [List of AMS Sources]

This selects an AMS source to control the **Oscillator 1 Balance**. For a list of AMS sources, see "Alternate Modulation Source (AMS) List" on page 1091.

**Intensity** [-99...+99]

This controls the depth and direction of the **Oscillator 1 Balance** AMS modulation.

**Phase Invert** [Off, On]

This inverts the phase of Oscillator 1.

### 4-3b: Oscillator 2

Oscillator 2 has the same mixer parameters as described under "4-3a: Oscillator 1," above.

### 4-3c: Sub OSC/Audio Input

In addition to the Level, Balance, AMS, and Phase Invert parameters described under "4-3a: Oscillator 1," above, this section has controls for using an external audio input.

**Mode** [Sub OSC, External Audio Input]

This selects whether the mixer input will be used for the Sub Oscillator, or the audio input selected below.

**External Audio** [Audio Inputs 1...4, S/P DIF L, S/P DIF R]

This selects the audio input used for both this mixer channel and the Ring Modulator.

The Ring Modulator can use the selected audio input even if **Mode**, above, is set to **Sub OSC**.

### 4-3d: Ring Mod

The Ring Modulator has the same mixer parameters as described under "4-3a: Oscillator 1," above.

### 4-3e: Noise

The Noise Generator has the same mixer parameters as described under "4-3a: Oscillator 1," above.

### ▼ 4-3: Page Menu Commands

The number before each command shows its ENTER + number-key shortcut. For more information on these shortcuts, see "ENTER + 0-9: shortcuts for menu commands" on page 147.

- 0: **Write Program**. For more information, see "Write Program" on page 147.
- 1: **Exclusive Solo**. For more information, see "Exclusive Solo" on page 147.

## 4-4: Pitch Common

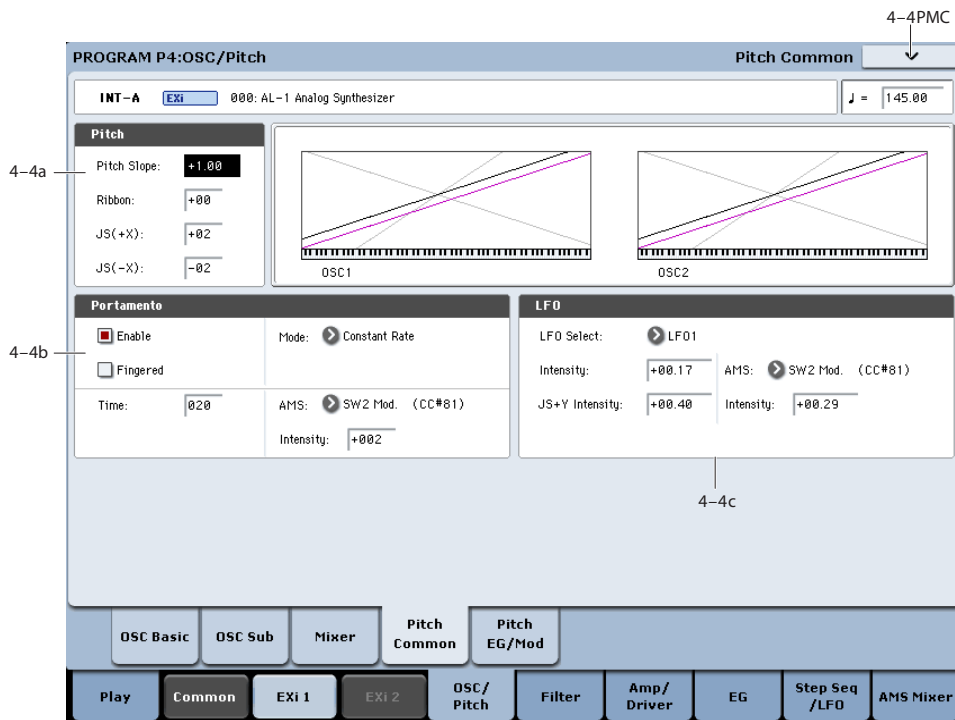

This page lets you modulate the pitch of Oscillators 1, 2, and the Sub Oscillator simultaneously, so that the modulation applies equally to all three oscillators. For example, you can:

- Set up pitch bend from both Joystick X (with separate settings for bending up and bending down) and the ribbon controller.
- Use Pitch Slope to control how the pitch changes when you play up and down the keyboard.
- Set up Portamento.
- Assign an LFO to modulate the pitch of all three oscillators simultaneously.

### 4-4a: Pitch

#### Pitch Slope [-1.00...+0.00...+2.00]

Normally, this should be set to the default of +1.00.

*Pitch Slope, pitch, and note*

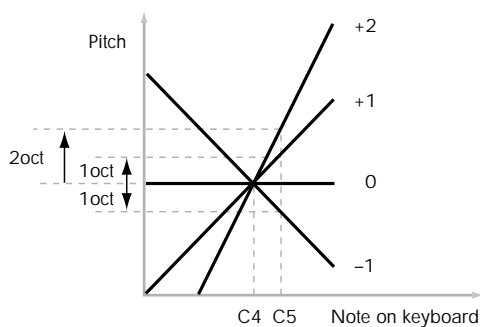

**Positive (+)** values cause the pitch to rise as you play higher on the keyboard, and **negative (-)** values cause the pitch to *fall* as you play higher on the keyboard.

When this is set to 0, playing different notes on the keyboard won't change the pitch at all; it will be as if you're always playing C4. This can be useful for special effects sounds, for instance.

If you want to create more complex effects, you can assign key tracking as an AMS source.

#### Ribbon [-60...+60 semitones]

You can use the ribbon controller for pitch-bend. This parameter specifies, in semitones, the ribbon's pitch-bend range.

**Positive (+)** values make the pitch rise when you press the ribbon controller to the right of center, and **negative (-)** values will cause the pitch to fall.

When you lift off of the ribbon, the pitch will snap back to the center (unless you're using the SW1/2 "Ribbon Lock" feature). So, by tapping on the right edge of the ribbon and then releasing quickly, you can create guitar-style "hammer-on" effects.

#### JS+ X [-60...+60 semitones]

This sets the maximum amount of pitch bend, in semitones, when you move the joystick to the right. For normal pitch bend, set this to a positive value.

#### JS- X [-60...+60 semitones]

This sets the maximum amount of pitch bend, in semitones, when you move the joystick to the left. For normal pitch bend, set this to a negative value.

## 4–4b: Portamento

Portamento lets the pitch glide smoothly between notes, instead of changing abruptly.

**Enable** [Off, On]

**On (checked):** Turns on Portamento, so that pitch glides smoothly between notes.

**Off (unchecked):** Turns off Portamento. This is the default state.

**Fingered** [Off, On]

This parameter allows you to control Portamento through your playing style. When it's enabled, playing legato will turn on Portamento, and playing detached will turn it off again.

This option is only available when Portamento Enable is turned on.

**On (checked):** Turns on Fingered Portamento.

**Off (unchecked):** Turns off Fingered Portamento.

**Mode** [Constant Rate, Constant Time]

Constant Rate means that Portamento will always take the same amount of time to glide a given distance in pitch - for instance, one second per octave. Put another way, gliding several octaves will take much longer than gliding a half-step.

Constant Time means that Portamento will always take the same amount of time to glide from one note to another, regardless of the difference in pitch. This is especially useful when playing chords, since it ensures that each note in the chord will end its glide at the same time.

**Time** [000...127]

This controls the portamento time. Higher values mean longer times, for slower changes in pitch. When **Time** is set to 0, the pitch will be reached instantly—just as if Portamento **Enable** was turned **Off**.

**AMS** [List of AMS Sources]

This selects an AMS source to control the **Portamento Time**. For a list of AMS sources, see “Alternate Modulation Source (AMS) List” on page 1091.

The modulation occurs only at note-on. This means that you can change the time for the *next* pitch glide, but you can't change any glides which are already in progress.

**Intensity** [-127...+127]

This controls the depth and direction of the **Portamento Time** AMS modulation.

### Assigning SW1 or SW2 to Portamento On/Off

You can use the two assignable switches, SW1 and SW2, to turn portamento on and off.

To do so:

1. Go to Program page 1-8, **Controller Setup**.
2. Under **Panel Switch Assign**, set either SW1 or SW2 to **Portamento SW (CC#65)**.

Now, the selected switch will enable and disable Portamento. It will also send the MIDI Portamento controller, CC#65.

**MIDI** Even if you don't assign SW1/2 to Portamento, you can still use MIDI Controller #65 to turn Portamento on and off.

## 4–4c: LFO

**LFO Select** [LFO 1, LFO 2, LFO 3, LFO 4, Common LFO]

This selects an LFO to modulate all oscillators simultaneously. This shared modulation can be useful for vibrato, among other things.

The **LFO Intensity**, **JS+ Y Intensity**, and **AMS** are all summed together to produce the final amount of LFO pitch modulation.

**LFO Intensity** [-48.00...+48.00]

This controls the initial effect of the LFO on the pitch, in semitones, before any JS+Y or AMS modulation.

**Negative (-)** settings will invert the phase of the LFO.

**JS+Y Intensity** [-48.00...+48.00]

Moving the joystick “up” from the center detent position, away from yourself, produces the JS+Y controller. You can use this to scale the amount of the LFO applied to the pitch. This parameter sets the maximum amount of LFO modulation added by JS+Y, in semitones.

As this value is **increased**, moving the joystick in the +Y direction will cause the LFO to produce deeper pitch modulation.

**Negative (-)** settings will invert the phase of the LFO. You can also use this to reduce the initial amount of the LFO, as set by **LFO1 Intensity**, above.

**AMS** [List of AMS Sources]

This selects an AMS modulation source to scale the amount of the LFO applied to pitch.

For a list of AMS sources, see “Alternate Modulation Source (AMS) List” on page 1091.

**Intensity** [-48.00...+48.00]

This controls the depth and direction of the LFO AMS modulation, in semitones.

## ▼ 4–4: Page Menu Commands

The number before each command shows its ENTER + number-key shortcut. For more information on these shortcuts, see “ENTER + 0-9: shortcuts for menu commands” on page 147.

- 0: **Write Program**. For more information, see “Write Program” on page 147.
- 1: **Exclusive Solo**. For more information, see “Exclusive Solo” on page 147.



## 4-5: Pitch EG/Mod

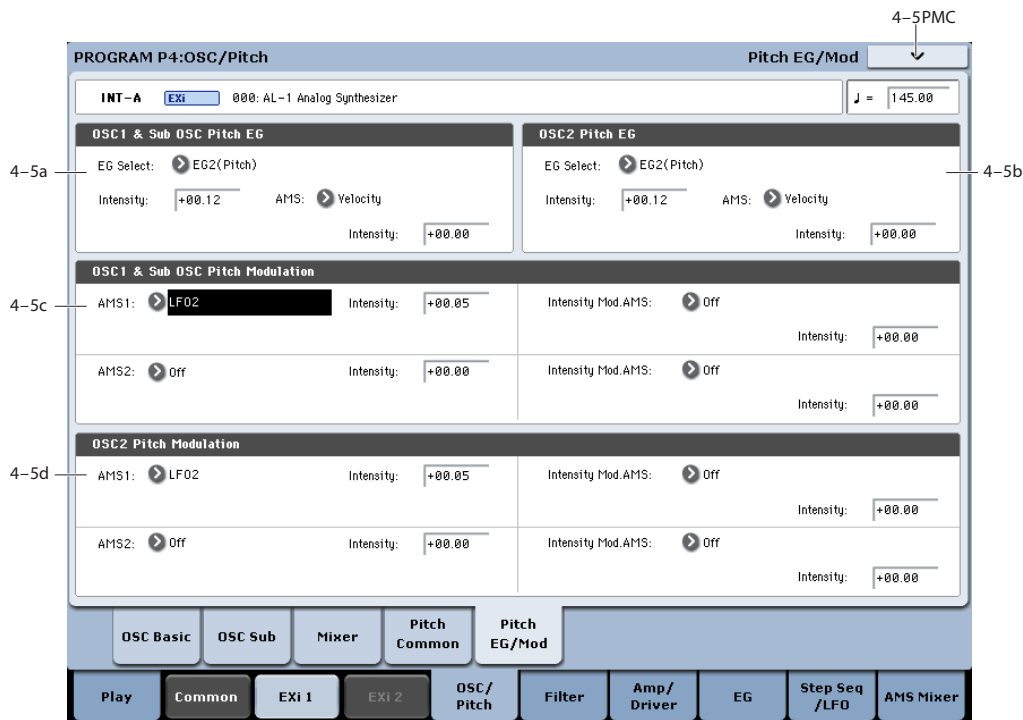

This page lets you modulate the pitches of Oscillators 1 and 2 separately—as opposed to the Pitch Common page, whose controls affect both Oscillators at once. All pitch modulation for Oscillator 1 also affects the Sub Oscillator.

### 4-5a: OSC 1 & Sub OSC Pitch EG

**EG Select** [EG 1 (Filter), EG 2 (Pitch), EG 3, EG 4, Amp EG]

This selects an EG to modulate the pitch of Oscillator 1 and the Sub Oscillator.

There are four assignable EGs, in addition to the Amp EG. Each of these can be used as a modulation source to control a wide variety of parameters.

In the midst of all this flexibility, we thought it would also be good to provide a little structure. With this in mind, EG 1 is named EG 1 (Filter) and EG 2 is labeled EG 2 (Pitch).

Please take these names as suggestions, rather than restrictions. If you like, you're free to use these EGs to control any EG or AMS destination, or to use other EGs to control Filter Frequency and Pitch.

**Intensity** [-48.00...+48.00]

This controls the initial effect of the Pitch EG on the frequency of Oscillators 1 and the Sub Oscillator, in half-steps, before any AMS modulation.

The Pitch EG's shape can swing all the way from +99 to -99. When the Intensity is set to a **positive (+)** value, positive values from the EG raise the pitch, and negative values lower the pitch.

When the Intensity is set to a **negative (-)** value, the effect of the EG is reversed; positive EG values mean *lower* pitches, and negative EG values mean *higher* pitches.

**AMS** [List of AMS Sources]

This selects an AMS modulation source to scale the amount of the Pitch EG applied to Oscillator 1 and the Sub Oscillator.

For a list of AMS sources, see "Alternate Modulation Source (AMS) List" on page 1091.

**Intensity** [-48.00...+48.00]

This controls the depth and direction of the pitch EG AMS modulation. The AMS modulation and the initial Intensity are added together to determine the Pitch EG's final effect.

### 4-5b: OSC 2 Pitch EG

Oscillator 2 has the same Pitch EG parameters as described under "4-5a: OSC 1 & Sub OSC Pitch EG," above.

### 4-5c: OSC 1 & Sub OSC Pitch Modulation

**AMS 1** [List of AMS Sources]

This selects the first modulation source for controlling the pitch of Oscillator 1 and the Sub Oscillator. For a list of AMS sources, see "Alternate Modulation Source (AMS) List" on page 1091.

**Intensity** [±48.00 semitones]

This controls the depth and direction of the AMS 1 pitch modulation, in semitones.

**Intensity Mod AMS [List of AMS Sources]**

You can modulate AMS 1's Intensity from another AMS source. This selects that source.

**Intensity [+/-48.00 semitones]**

This controls the depth and direction of the Intensity Mod AMS, in semitones. The result is summed with the main AMS 1 Intensity to produce the final pitch modulation amount.

**AMS 2 [List of AMS Sources]**

This selects a second modulation source for controlling the pitch of Oscillator 1 and the Sub Oscillator. For a list of AMS sources, see "Alternate Modulation Source (AMS) List" on page 1091.

**Intensity [+/-48.00 semitones]**

This controls the depth and direction of the AMS 2 pitch modulation, in semitones.

**Intensity Mod AMS [List of AMS Sources]**

You can modulate AMS 2's Intensity from another AMS source. This selects that source.

**Intensity [+/-48.00 semitones]**

This controls the depth and direction of the Intensity Mod AMS, in semitones. The result is summed with the main AMS 2 Intensity to produce the final pitch modulation amount.

---

**4-5d: OSC 2 Pitch Modulation**

Oscillator 2 has the same Pitch Modulation parameters as described under "4-5c: OSC 1 & Sub OSC Pitch Modulation," above.

---

**▼ 4-5: Page Menu Commands**

The number before each command shows its ENTER + number-key shortcut. For more information on these shortcuts, see "ENTER + 0-9: shortcuts for menu commands" on page 147.

- 0: **Write Program.** For more information, see "Write Program" on page 147.
- 1: **Exclusive Solo.** For more information, see "Exclusive Solo" on page 147.

## Program P5: Filter

### 5-1: Filter Basic

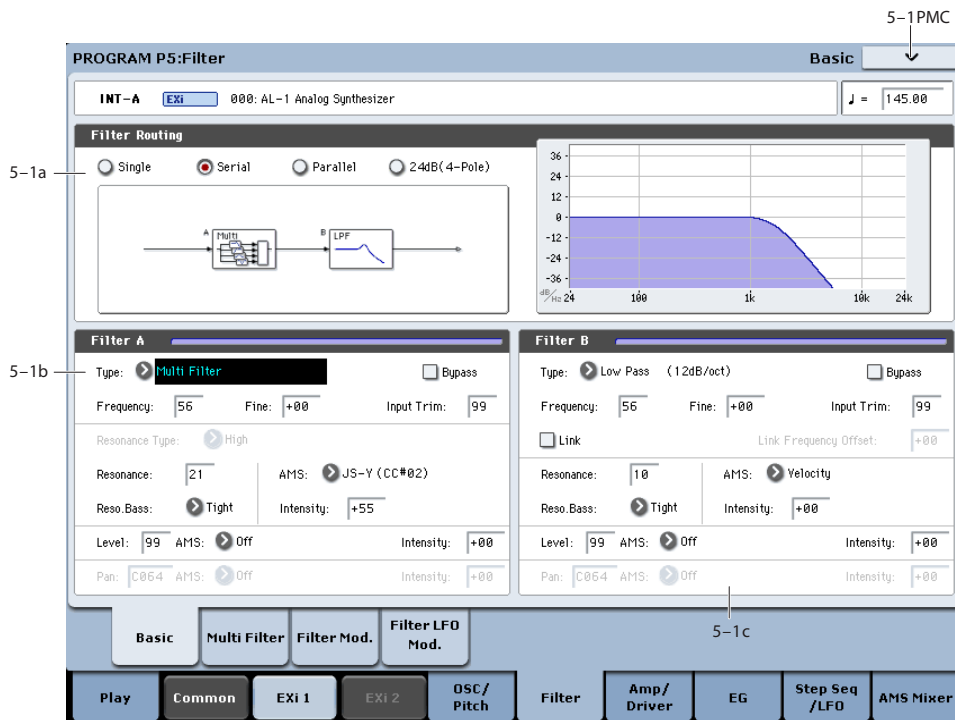

#### Interaction between the filters and the mixer

When the **Filter Routing** is set to either **Single** or **24dB/oct**, the routing from the Oscillator section into the Filter section is fairly simple. There's only a single filter, and that filter processes all of the Oscillator elements.

Things can get more interesting when the **Filter Routing** is set to **Serial** or **Parallel**. In these modes, The Mixer page's **Balance** parameters let you separately control the filter routing for each of the five inputs: Oscillator 1, Oscillator 2, the Sub Oscillator, the Ring Modulator, and the Noise Generator.

When an input's **Balance** is set to **0**, it goes into Filter A. (Note that if the **Filter Routing** is set to **Serial**, the signal will also pass through Filter B.)

If the input's **Balance** is set to **99**, it goes directly into Filter B, regardless of whether the routing is set to **Serial** or **Parallel**.

#### Standard serial configuration

To create a standard serial filter configuration:

1. **Set the Filter Routing to Serial.**

This connects the output of Filter A to the input of Filter B.

2. **Set all of the mixer's Balance controls to 0.**

This makes all of the inputs go to Filter A first, and then through Filter B.

#### Standard parallel configuration

To create a standard parallel filter configuration:

1. **Set the Filter Routing to Parallel.**
2. **Set all of the mixer's Balance controls to 50.**

This routes all of the inputs to both filters, at equal volumes.

#### Dual signal paths

You can also send one Oscillator through Filter A, and the other through Filter B, to create a layered sound. For instance:

1. **Set the Filter Routing to Parallel.**
2. **Set Oscillator 1's Balance to 0.**

This routes Oscillator 1 to Filter A.

3. **Set Oscillator 2's Balance to 99.**

This routes Oscillator 2 to Filter B.

#### Anywhere in-between

If an input's **Balance** is set between **1** and **98**, it will go to a combination of both filters—so that many “in between” filter effects are available.

Finally, by modulating an input's **Balance** via AMS, you can crossfade between routing through Filter A and Filter B.

## 5-1a: Routing

### Filter Routing [Single, Serial, Parallel, 24dB/oct]

There are two filters, Filter A and Filter B. This parameter controls whether one or both of the filters are used, and if both are used, it controls how they are connected to each other.

**Single.** This uses only Filter A as a single 2-pole, 12dB/octave filter (6dB for Band Pass and Band Reject). When this option is selected, the controls for Filter B will be grayed out. A classic synthesizer expander module used this type of filter.

**Serial.** This uses both Filters A and B as separately controllable 2-pole filters. The output of Filter A is processed through Filter B.

**Parallel.** This also uses both Filter A and Filter B. Unlike Serial, above, the outputs of the two filters are kept separate, with individual control over both level and pan.

**24dB/oct.** This merges both filters to create a single 4-pole, 24dB/octave filter (12dB for Band Pass and Band Reject). In comparison to Single, this option produces a sharper roll-off beyond the cutoff frequency, as well as a slightly more delicate resonance. Many classic analog synths used this general type of filter.

When **24dB/oct** is selected, only the controls for Filter A are active; the controls for Filter B will be grayed out. Also, note that the **Multi Filter** is not available in this mode.

## 5-1b: Filter A

### Filter Type [Low Pass, High Pass, Band Pass, Band Reject, Multi Filter]

The filter will produce very different results depending on the selected filter type. The selections will change slightly according to the selected **Filter Routing**, to show the correct cutoff slope in dB per octave.

**Low Pass.** This cuts out the parts of the sound which are **higher** than the cutoff frequency. Low Pass is the most common type of filter, and is used to make bright timbres sound darker.

**High Pass.** This cuts out the parts of the sound which are **lower** than the cutoff frequency. You can use this to make timbres sound thinner or more buzzy.

**Band Pass.** This cuts out all parts of the sound, both highs and lows, except for the region around the cutoff frequency. Since this filter cuts out both high and low frequencies, its effect can change dramatically depending on the cutoff setting and the oscillator's multisample.

With low resonance settings, you can use the Band Pass filter to create telephone or vintage phonograph sounds. With higher resonance settings, it can create buzzy or nasal timbres.

**Band Reject.** This filter type—also called a notch filter—cuts only the parts of the sound directly around the cutoff frequency. Try modulating the cutoff with an LFO to create phaser-like effects.

**Multi Filter.** This is a complex filter which is capable of all of the above filter types, and many more besides. For more information, see “5-2: Multi Filter,” on page 199.

The Multi Filter is available only for Filter A, and only when the Filter Routing is set to **Single**, **Serial** or **Parallel**.

### Filter Types and Cutoff Frequency

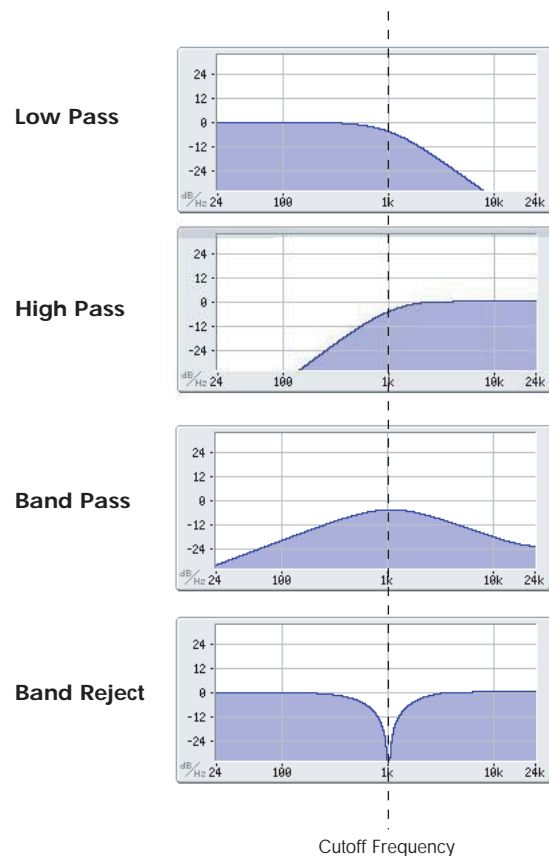

### Bypass

[Off, On]

This lets you bypass Filter A completely.

If **Bypass** is **Off**, Filter A functions normally.

When **Bypass** is **On**, Filter A has no effect on the input signal.

### Trim

[00...99]

This adjusts the volume level at the input to Filter A. If you notice that the sound is distorting, especially with high Resonance settings, you can turn the level down here, or at the Output Level.

Note that the filter will not clip internally, so there is no difference between adjusting the Input Trim and the Output Level. Either of these controls will allow you to minimize clipping later in the signal chain, such as may occur in the Drive section and in some effects.

### Output Level

[00...99]

This controls the output level of Filter A. You can use this to balance the volumes of Filters A and B when the Routing is set to Parallel, or to turn down the volume to avoid clipping later in the signal chain.

**AMS** [List of AMS Sources]

This selects a modulation source to control the **Output Level**. For a list of AMS sources, see “Alternate Modulation Source (AMS) List” on page 1091.

**Intensity** [-99...+99]

This controls the depth and direction of the **Output Level** modulation.

**Frequency** [00...99]

This controls the cutoff frequency of Filter A, in increments of 1/10 of an octave. The specific effect of the cutoff frequency will change depending on the selected **Filter Type**, as described above.

**Frequency Fine** [-99...+99]

This provides fine control of the filter cutoff frequency. Each step of this parameter is equal to 1/100 of a step of the main **Frequency** parameter, above.

**Resonance Type** [Standard, High]

This controls the strength of the filter resonance when the **Filter Routing** is set to **24dB/oct**. When the routing is set to **Single**, **Serial**, or **Parallel**, this parameter is grayed out.

**Standard** provides the resonance character of a typical analog 4-pole filter.

**High** creates a more pronounced resonance.

**Resonance Bass** [Tight, Full]

This controls the character of the filter resonance at low cutoff frequencies. Its effect is most noticeable with high **Resonance** settings.

**Tight** produces a more restrained resonance, similar to a classic, American, wood-paneled monophonic synthesizer.

**Full** produces a wide, boomy resonance, reminiscent of a famous five-voice American synthesizer.

**Resonance** [00...99]

Resonance emphasizes the frequencies around the cutoff frequency.

When this is set to **0**, there is no emphasis, and frequencies beyond the cutoff will simply diminish smoothly.

At medium settings, the resonance will alter the timbre of the filter, making it sound more nasal, or more extreme.

At very high settings, the resonance can be heard as a separate, whistling pitch.

To make the resonance track the keyboard pitch, see “Key Follow,” on page 201.

**Resonance Mod by AMS** [List of AMS Sources]

This selects a modulation source to control the Resonance amount. For a list of AMS sources, see “Alternate Modulation Source (AMS) List” on page 1091.

**Intensity** [-99...+99]

This controls the depth and direction of the **Resonance** modulation.

**Pan** [Random, L001...C064...R127]

This controls the stereo pan for Filter A’s output. It is available only when **Filter Routing** is set to **Parallel**.

When the **Filter Routing** is set to **Single**, **Serial**, or **24dB/oct**, the Pan parameters will be grayed out.

**AMS** [List of AMS Sources]

This selects an AMS source to modulate **Pan**. For a list of AMS sources, see “Alternate Modulation Source (AMS) List” on page 1091.

**Intensity** [-99...+99]

This controls the depth and direction of the **Pan** AMS modulation.

---

**5-1c: Filter B**

Filter B is available when the **Filter Routing** is set to **Serial** or **Parallel**. Otherwise, its parameters will be grayed out.

Filter B is almost the same as Filter A, but without the **Multi Filter** mode, and with the addition of the **Link** controls, as described below. For all other parameters, please see the descriptions under “5-1b: Filter A,” on page 197.

**Link** [Off, On]

When **Link** is **On**, most of Filter B’s parameters are grayed out, and are instead controlled by the settings for Filter A.

Specifically, Filter B will use Filter A’s settings for **Resonance**, **Resonance Bass**, and all Frequency and Resonance modulation settings. Filter B’s **Frequency** is also linked to that of Filter A, with an optional frequency offset via the **Link Frequency Offset** parameter, below.

The **Bypass**, **Type**, **Input Trim**, **Output Level**, **Output Level AMS**, **Pan**, and **Pan AMS** parameters are still controlled separately.

**Link Frequency Offset** [-99...+99]

This offsets Filter B’s Frequency from that of Filter A, and applies only when **Link** is **On**.

When **Link** is **Off**, this parameter is grayed out.

---

**▼ 5-1: Page Menu Commands**

The number before each command shows its ENTER + number-key shortcut. For more information on these shortcuts, see “ENTER + 0-9: shortcuts for menu commands” on page 147.

- **0: Write Program**. For more information, see “Write Program” on page 147.
- **1: Exclusive Solo**. For more information, see “Exclusive Solo” on page 147.

## 5-2: Multi Filter

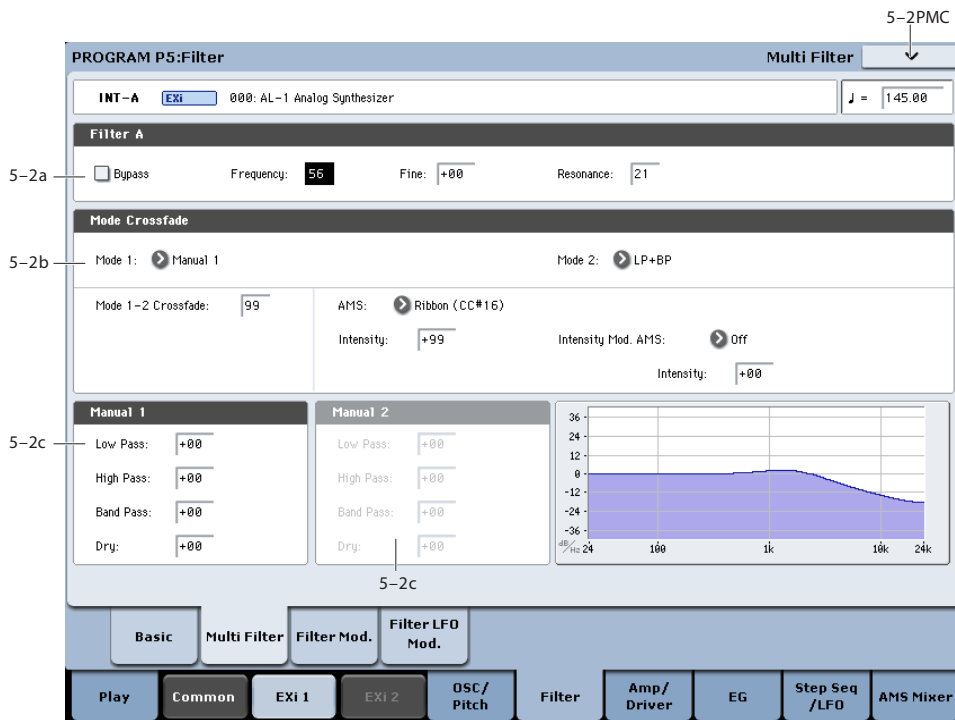

This page is available only when the **Filter A Type** is set to **Multi Filter**.

### What's a Multi Filter?

Standard multimode filters generate lowpass, highpass, and bandpass filters simultaneously - but only allow you to use one of them at a time.

The Multi Filter gives you access to all three filter modes simultaneously, in any combination, along with the dry input signal. You can choose from a large number of preset combinations, or create your own complex filter modes using the Manual controls.

This is capable of some cool sounds in and of itself, but things really get interesting when you use the Crossfade controls. These allow you to crossfade between two of these filter settings (Mode 1 and Mode 2), using AMS sources such as EGs, LFOs, or real-time controllers.

### 5-2a: Filter A

<b>Bypass</b>	<b>[Off, On]</b>
<b>Frequency</b>	<b>[00...99]</b>
<b>Fine</b>	<b>[-99...+99]</b>
<b>Resonance</b>	<b>[00...99]</b>

These are the same as the similarly-named parameters on the Filter Basic page, as described under "5-1b: Filter A" on page 197.

Edits to the values on this page will be reflected on the Filter Basic page, and vice-versa.

### 5-2b: Mode Crossfade

#### Mode 1 [List of filter types]

This sets the filter type for Mode 1.

**Low Pass, High Pass, Band Pass, and Band Reject** are the standard filter types. For more information, see "Filter Type," on page 197.

The following types combine two or more filters at equal volumes. **Dry** is the un-filtered input signal. The minus sign ("-") indicates when the phase of a filter is reversed: **LP+BP, LP-BP, LP-HP, BP+HP, BP-HP, Dry+LP, Dry-LP, Dry+BP, Dry-BP, Dry+LP-HP, Dry+LP-BP, Dry+BP-LP, Dry+BP-HP, Dry+HP-LP, Dry+HP-BP, LP+HP+BP.**

**All On** uses the Low Pass, High Pass, Band Pass, and Dry signals at equal volumes.

Manual 1 lets you create your own mix of the filters. For more information, see "5-2c: Manual 1," below.

#### Mode 2 [List of filter types]

Mode 2 has the same selections as Mode 1, except that the list ends with Manual 2 instead of Manual 1.

#### Mode 1-2 Crossfade [00...99]

This fades between the Mode 1 and Mode 2 settings.

0 is all **Mode 1**, 99 is all **Mode 2**, and 1-98 are intermediate values between the two Modes.

#### AMS [List of AMS Sources]

This selects a modulation source to control the **Mode 1-2 Crossfade**. For a list of AMS sources, see "Alternate Modulation Source (AMS) List" on page 1091.

**Intensity** [-99...+99]

This controls the depth and direction of the **Mode 1-2 Crossfade** modulation.

**Intensity Mod AMS** [List of AMS Sources]

This selects an AMS source to modulate the intensity of the main **Mode 1-2 Crossfade AMS**.

For instance, you can set **AMS** to use one of the LFOs, and then set the **Intensity Mod AMS** to JS -Y. You can then use the joystick to modulate the amount of the LFO.

**Intensity** [-99...+99]

This controls the depth and direction of the **Intensity Mod AMS**.

**5-2c: Manual 1**

These parameters let you create your own mix of the filters. When **Mode 1** is set to **Manual 1**, it will use these settings.

You may wonder why Band Reject is not included here. This is because it's not a filter mode per se. Instead, it's created by an equal combination of High Pass and Low Pass. Try it and see!

**Lowpass** [-99...+99]

This controls the volume of the Lowpass filter output. Negative values invert the phase.

**Highpass** [-99...+99]

This sets the volume of the Highpass filter output.

**Bandpass** [-99...+99]

This controls the volume of the Bandpass filter output.

**Dry** [-99...+99]

This sets the volume of the dry signal.

**5-2d: Manual 2**

The Manual 2 parameters are identical to those of Manual 1, as described above.

▼ **5-2: Page Menu Commands**

The number before each command shows its ENTER + number-key shortcut. For more information on these shortcuts, see "ENTER + 0-9: shortcuts for menu commands" on page 147.

- **0: Write Program.** For more information, see "Write Program" on page 147.
- **1: Exclusive Solo.** For more information, see "Exclusive Solo" on page 147.

**5-3: Filter Modulation**

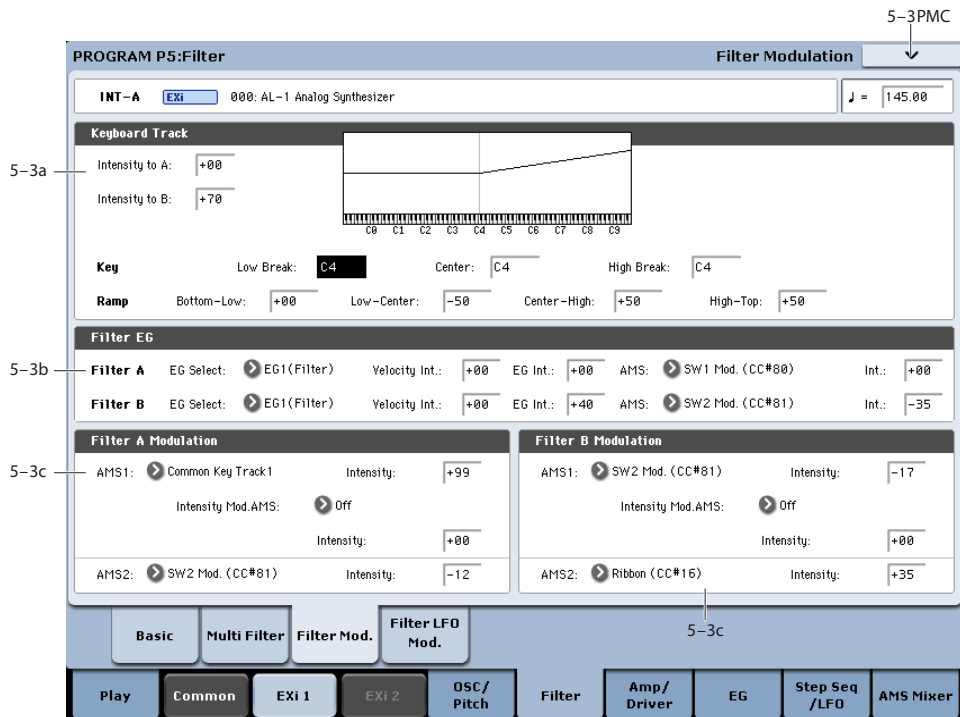

This page contains all of the settings for **Filter Frequency** modulation (except for the LFOs, which are on their own page). Among other things, you can:

- Set up complex keyboard tracking shapes, and control how the tracking affects filter cutoff.

- Control the effect of the Filter Envelope on filter cutoff.
- Assign AMS modulation for filter cutoff.

Filter B is available when the **Filter Routing** is set to **Serial** or **Parallel**. Otherwise, the parameters for Filter B will be grayed out.



### 5–3a: Keyboard Track AMSource

Most acoustic instruments get brighter as you play higher pitches. At its most basic, keyboard tracking re-creates this effect by increasing the cutoff frequency of a lowpass filter as you play higher on the keyboard. Usually, some amount of key tracking is necessary in order to make the timbre consistent across the entire range.

The KRONOS keyboard tracking can also be much more complex, since it allows you to create different rates of change over up to four different parts of the keyboard.

The AL-1’s Filter keyboard tracking parameters are identical to the HD-1’s. For more detailed explanations of the parameters, please see “3–2a: Keyboard Track,” on page 72.

There is one difference between the two, however: the AL-1’s Filter tracking is affected by Portamento, so that it changes smoothly during glides.

#### Intensity to A [–99...+99]

This controls how much the keyboard tracking will affect Filter A’s cutoff frequency. The overall effect of the Keyboard Track is a combination of this Intensity value and the overall Keyboard Track shape.

#### Intensity to B [–99...+99]

This controls how much the keyboard tracking will affect Filter B’s cutoff frequency.

Intensity to B applies only when the Filter Routing is set to **Serial** or **Parallel**, and when Link is **Off**. In **Single** and **24dB/oct** modes, or if Link is **On**, this parameter is grayed out.

#### Key

#### Low Break [C–1...G9]

This sets the breakpoint note between the two lower ramps.

#### Center [C–1...G9]

This sets the center of the keyboard tracking. At this key, the keyboard tracking has no effect on the filter frequency, or on any AMS destinations.

#### High Break [C–1...G9]

This sets the breakpoint note between the two higher ramps.

#### Ramp

The effect on the filter cutoff is a combination of the ramp values, as set below, and the Intensity to A and B parameters. When Intensity is set to +99, a ramp of 50 changes the filter frequency by 1 octave for every octave of the keyboard, and a ramp of +99 changes the frequency by 2 octaves for every octave of the keyboard.

+Inf and –Inf are special settings which create abrupt changes for split-like effects. When a ramp is set to +Inf or –Inf, the keyboard tracking will go to its extreme highest or lowest value over the span of a single key.

For more detailed explanations, please see “3–2a: Keyboard Track,” on page 72

#### Bottom-Low [–Inf, –99...+99, +Inf]

This sets the slope between the bottom of the MIDI note range and the Low Break key. For normal key track, use negative values.

#### Low-Center [–Inf, –99...+99, +Inf]

This sets the slope between the Low Break and Center keys. For normal key track, use negative values.

#### Center-High [–Inf, –99...+99, +Inf]

This sets the slope between the Center and High Break keys. For normal key track, use positive values.

#### High-Top [–Inf, –99...+99, +Inf]

This sets the slope between the High Break key and the top of the MIDI note range. For normal key track, use positive values.

#### Key Follow

To create the classic Key Follow effect, in which the filter frequency tracks the pitch of the keyboard:

1. Set the Filter Frequency to 30.
2. Set the Keyboard Track Intensity to +99.
3. Set the Bottom-Low and Low-Center ramps to -50.
4. Set the Center-High and High-Top ramps to +50.
5. Set the Center Key to C4.

The settings for the Low Break and High Break keys don’t matter in this case.

### 5–3b: Filter EG

The EGs modulate the Filter A and B cutoff frequencies over time. You can control how strongly they will affect the filters in three different ways:

- Set an initial amount of EG modulation, using the EG Intensity parameters.
- Use velocity to scale the amount of the EG applied to the filter.
- Use any AMS source to scale the amount of the EG applied to the filter.

You can use all three of these at once, and the results are added together to produce the total EG effect.

To set up the EGs themselves, including attack and release times, levels, and so on, see “7–1: EG 1 (Filter),” on page 211.

#### Filter A

#### EG Select [EG 1 (Filter), EG 2 (Pitch), EG 3, EG 4, Amp EG]

This selects an EG to modulate Filter A’s Frequency.

There are four assignable EGs, in addition to the Amp EG. Each of these can be used as a modulation source to control a wide variety of parameters.

In the midst of all this flexibility, we thought it would also be good to provide a little structure. With this in mind, EG 1 is named EG 1 (Filter) and EG 2 is labeled EG 2 (Pitch).

Please take these names as suggestions, rather than restrictions. If you like, you're free to use these EGs to control any EG or AMS destination, or to use other EGs to control Filter Frequency and Pitch.

**Velocity Intensity** [-99...+99]

This lets you use velocity to scale the amount of the EG applied to Filter A.

**EG Intensity** [-99...+99]

This controls the initial effect of the EG on Filter A's cutoff frequency, before any velocity or AMS modulation.

**AMS** [List of AMS Sources]

This selects an AMS modulation source to scale the amount of the EG applied to Filter A.

For a list of AMS sources, see "Alternate Modulation Source (AMS) List" on page 1091.

**Intensity** [-99...+99]

This controls the depth and direction of the AMS modulation.

**Filter B**

The EG parameters for Filter B are the same as those for "Filter A," above.

When **Link** is **On**, or when the Filter Routing is set to **Single** or **24dB/oct**, all of these parameters are grayed out.

When **Link** is **On**, or when the Filter Routing is set to **Single** or **24dB/oct**, all of these parameters are grayed out.

---

**▼ 5-3: Page Menu Commands**

The number before each command shows its ENTER + number-key shortcut. For more information on these shortcuts, see "ENTER + 0-9: shortcuts for menu commands" on page 147.

- **0: Write Program.** For more information, see "Write Program" on page 147.
- **1: Exclusive Solo.** For more information, see "Exclusive Solo" on page 147.

---

**5-3c: Filter Modulation****Filter A Frequency****AMS 1** [List of AMS Sources]

This selects the first modulation source to control Filter A's **Frequency**. For a list of AMS sources, see "Alternate Modulation Source (AMS) List" on page 1091.

**Intensity** [-99...+99]

This controls the depth and direction of the **Frequency** modulation.

**Intensity Mod AMS** [List of AMS Sources]

This selects an AMS source to modulate the intensity of **AMS 1**.

**Intensity** [-99...+99]

This controls the depth and direction of the **Intensity Mod AMS**.

**AMS 2** [List of AMS Sources]

This selects a second modulation source to control Filter A's **Frequency**. For a list of AMS sources, see "Alternate Modulation Source (AMS) List" on page 1091.

**Intensity** [-99...+99]

This controls the depth and direction of **AMS 2**.

**Filter B Frequency**

The settings for Filter B are the same as those for "Filter A Frequency," above.

## 5-4: Filter LFO Mod

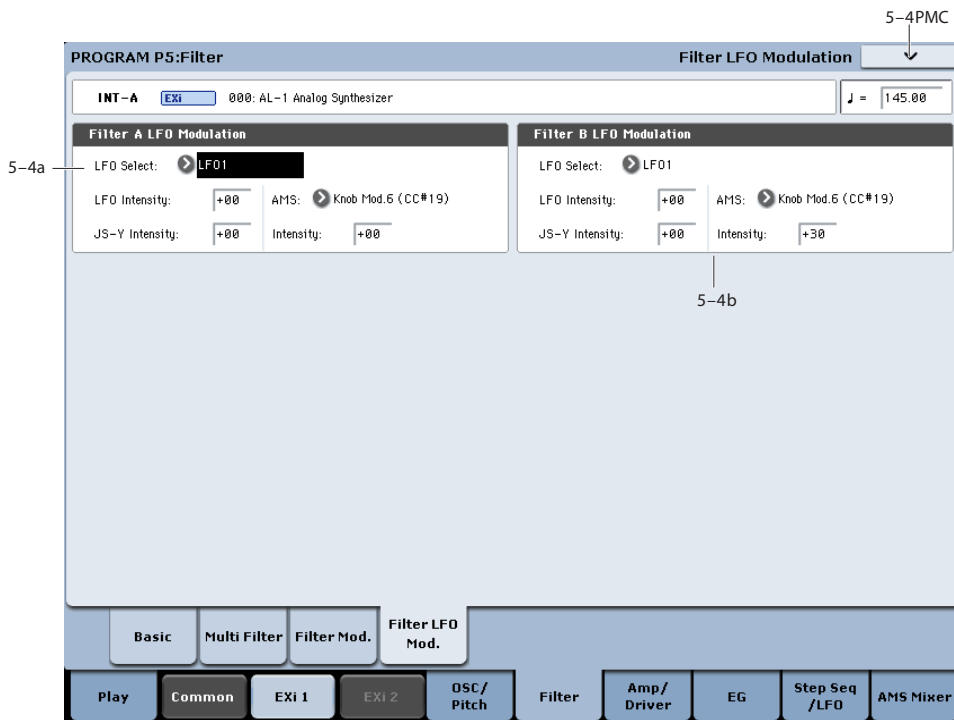

There are three LFO-to-Frequency controls for each filter: a basic amount (**LFO Intensity**), joystick -Y control of LFO amount (**JS- Y Intensity**), and AMS control of LFO amount (**AMS Intensity**). The three controls are summed together to determine the final LFO amount.

For a list of AMS sources, see “Alternate Modulation Source (AMS) List” on page 1091.

### Intensity [-99...+99]

This controls the depth and direction of the LFO AMS modulation.

### 5-4a: Filter A

#### LFO Select [LFO 1, LFO 2, LFO 3, LFO 4, Common LFO]

This selects an LFO to modulate Filter A’s cutoff frequency.

The **LFO Intensity**, **JS -Y Intensity**, and **AMS** are all summed together to produce the final amount of LFO pitch modulation.

#### LFO Intensity [-99...+99]

This controls the initial effect of the LFO on Filter A’s cutoff frequency, before any JS+Y or AMS modulation.

**Negative (-)** settings will invert the phase of the LFO.

#### JS -Y Intensity [-99...+99]

Moving the joystick “down” from the center detent position, towards yourself, produces the JS -Y controller. You can use this to scale the amount of the LFO applied to Filter A.

This parameter sets the maximum amount of LFO modulation added by JS -Y.

#### AMS [List of AMS Sources]

This selects an AMS modulation source to scale the amount of the LFO applied to Filter A’s cutoff frequency.

### 5-4b: Filter B

The settings for Filter B are the same as those for “5-4a: Filter A,” above.

When **Link** is **On**, or when the Filter Routing is set to **Single** or **24dB/oct**, all of these parameters are grayed out.

### ▼ 5-4: Page Menu Commands

The number before each command shows its ENTER + number-key shortcut. For more information on these shortcuts, see “ENTER + 0-9: shortcuts for menu commands” on page 147.

- 0: **Write Program**. For more information, see “Write Program” on page 147.
- 1: **Exclusive Solo**. For more information, see “Exclusive Solo” on page 147.

## Program P6: Amp

These pages let you control the sound's volume (also called "amplitude," or "amp" for short), pan, and Drive, as well as its dedicated amp envelopes and keyboard tracking generators. For instance, you can:

- Set up the Driver circuit, which adds saturation and bass boost to the timbre.

- Set the pan position and pan modulation.
- Control amp level and modulation, including keyboard tracking, the amp envelope, LFO modulation, and AMS control.

### 6-1: Amp/Driver

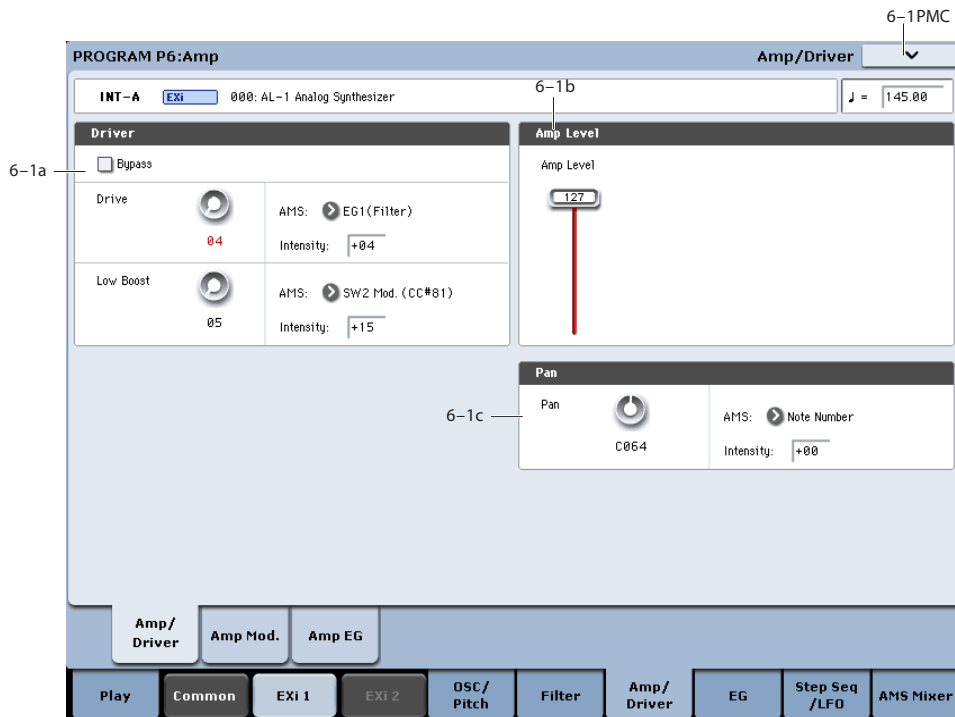

This page controls the basic settings for the Amp section. Here, you can:

- Set up the Driver circuit.
- Set the initial volume level.
- Control the pan position and pan modulation.

#### 6-1a: Driver

The Driver adds saturation and overdrive to the sound, for everything from subtle fattening to drastic distortion. Unlike an overdrive effect, the Driver processes each voice individually, so the timbre stays the same regardless of how many voices are being played.

The two main parameters, Drive and Low Boost, work together to create the overall Driver effect. Drive contributes edge and bite, and Low Boost provides the body as well as boosting the bass.

 Although the oscillators themselves have extremely low aliasing, the Driver can produce aliasing—especially at higher frequencies. If your goal is a completely pristine sound, set the Driver's **Bypass** to **On**. Otherwise, let it rip!

#### **Bypass** [Off, On]

When **Bypass** is **On**, the Driver is completely removed from the signal path.

#### **Drive** [0...99]

This controls the amount of edge and bite in the timbre. Low settings will produce mild saturation, and higher settings create more obvious distortion.

Often, it's useful to increase the **Low Boost** along with the **Drive**.

Note: even when the **Drive** amount is set to 0, the Driver circuit still affects the timbre. If your goal is a completely pristine sound, use the **Bypass** control instead.

#### **AMS** [List of AMS Sources]

This selects an AMS modulation source to control the **Drive** amount. For a list of AMS sources, see "Alternate Modulation Source (AMS) List" on page 1091.

#### **Intensity** [-99...+99]

This controls the depth and direction of the AMS modulation for **Drive**.

**Low Boost** [0...99]

This low-frequency EQ controls the body character of the sound. The specific EQ frequencies affected will change with the **Drive** setting.

Higher amounts increase the bass boost, and will also intensify the effect of the **Drive** parameter.

**AMS** [List of AMS Sources]

This selects an AMS modulation source to control the **Low Boost** amount. For a list of AMS sources, see "Alternate Modulation Source (AMS) List" on page 1091.

**Intensity** [-99...+99]

This controls the depth and direction of the AMS modulation for **Low Boost**.

---

**6-1b: Amp Level**

**Amp Level** [0...127]

This controls the basic volume level of the AL-1, before keyboard tracking, velocity, and other modulation.

**The Control Surface and volume**

You can also control the volumes of EXi 1 and 2 directly from the Control Surface sliders. These volume levels are separate parameters, in addition to the individual EXi Amp Levels. To do so:

1. Press the Control Surface Timbre/Track button.
2. Move Slider 1 to set the volume for EXi 1, and Slider 2 for EXi 2.

**MIDI and volume**

**MIDI** You can control the Program's overall volume via MIDI using both Volume (CC#7) and Expression (CC#11). When used one at a time, the two controllers work in exactly the same way: a MIDI value of 127 is equal to the Amp Level setting, and lower values reduce the volume.

If both CC#7 and CC#11 are used simultaneously, the one with the *lower* value determines the maximum volume, and the one with the higher value scales down from that maximum.

---

**6-1c: Pan**

**Pan** [Random, L001...C064...R127]

This controls the stereo pan of the EXi. A setting of **L001** places the sound at the far left, **C064** in the center, and **R127** to the far right.

When this is set to **Random**, the pan position will be different for each note-on.

You can also set this Pan parameter directly from the Control Surface knobs. To do so:

1. Press the Control Surface Timbre/Track button.
2. Set the MIXER KNOBS switch to INDIVIDUAL PAN.
3. Move Knob 1 to set the pan for EXi 1, and Knob 2 to set the pan for EXi 2.

**MIDI** You can also control pan via MIDI Pan (CC#10). A CC#10 value of 0 or 1 places the sound at the far left, 64 places the sound at the location specified by the **Pan** parameter, and 127 places the sound at the far right.

Note: you can select Random pan only from the on-screen UI, and not from MIDI or the Control surface.

**AMS** [List of AMS Sources]

This selects an AMS source to modulate **Pan**. For a list of AMS sources, see "Alternate Modulation Source (AMS) List" on page 1091.

**Intensity** [-99...+99]

This controls the depth and direction of the AMS modulation for **Pan**.

For example, if **Pan** is set to C064 and **AMS** is set to Note Number, **positive (+)** intensities will cause the sound to move toward the right as you play higher than C4, and toward the left as you play lower than C4.

**Negative (-)** intensities will have the opposite effect.

---

**▼ 6-1: Page Menu Commands**

The number before each command shows its ENTER + number-key shortcut. For more information on these shortcuts, see "ENTER + 0-9: shortcuts for menu commands" on page 147.

- 0: **Write Program**. For more information, see "Write Program" on page 147.
- 1: **Exclusive Solo**. For more information, see "Exclusive Solo" on page 147.

## 6-2: Amp Modulation

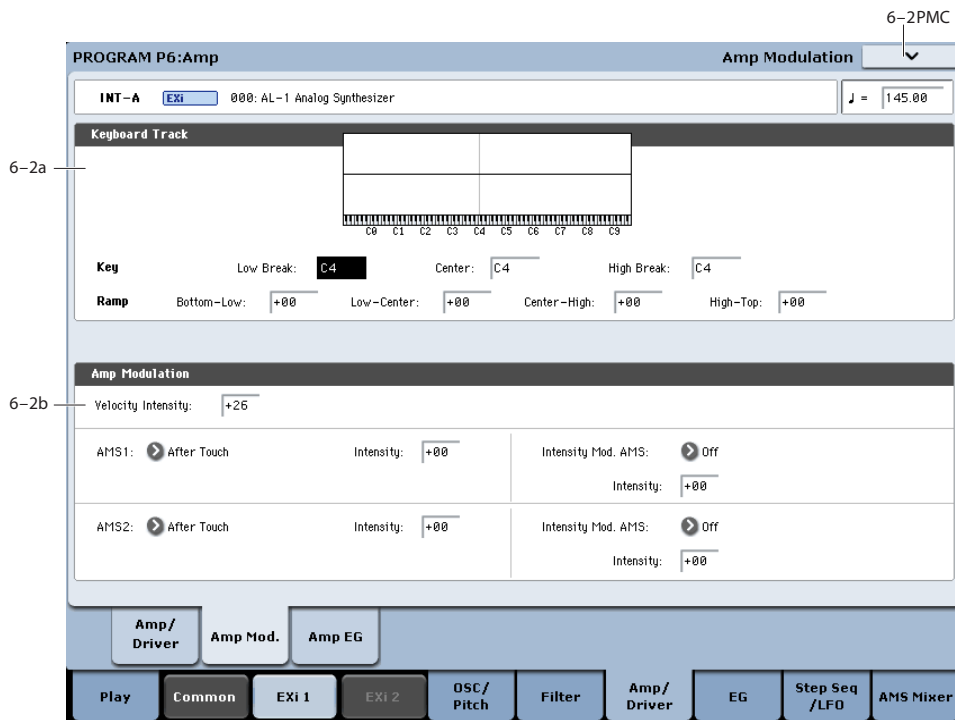

This page contains the settings for Oscillator 1’s Amp level modulation. Among other things, you can:

- Set up complex keyboard tracking shapes to control the Amp level.
- Assign AMS modulation for the Amp level.
- Control the effect of the LFOs on the Amp level.

The total effects of the modulation can increase the volume to a maximum of two times louder than the Amp Level setting.

### 6-2a: Keyboard Track AMSSource

Keyboard tracking lets you vary the volume as you play up and down the keyboard. Usually, some amount of key tracking is necessary in order to make the volume consistent across the entire range.

The AL-1’s Amp keyboard tracking parameters are identical to the HD-1’s. In both cases, the Amp keyboard tracking works somewhat differently from the Filter and Common keyboard tracking. For more detailed explanations of the parameters, please see “4-2a: Keyboard Track,” on page 84.

There is one difference between the two, however: the AL-1’s Amp tracking is affected by Portamento, so that it changes smoothly during glides.

#### Key

#### Low Break [C-1...G9]

This sets the breakpoint note between the two lower ramps.

#### Center [C-1...G9]

This sets the center of the keyboard tracking. At this key, the keyboard tracking has no effect on the volume, or on any AMS destinations.

#### High Break [C-1...G9]

This sets the breakpoint note between the two higher ramps.

#### Ramp

#### Bottom-Low [-Inf, -99...+99, +Inf]

This sets the slope between the bottom of the MIDI note range and the Low Break key. For normal key track, use negative values.

Ramp	Change in level
-Inf	Silent in one half-step
-99	Silent in one whole-step
-95	Silent in one octave
-48	Silent in two octaves
-25	Silent in four octaves
00	no change
+25	x2 in four octaves
+50	x2 in two octaves
+99	x2 in one octave
+Inf	x2 in one half-step

#### Low-Center [-Inf, -99...+99, +Inf]

This sets the slope between the Low Break and Center keys. For normal key track, use negative values.

**Center-High** [-Inf, -99...+99, +Inf]

This sets the slope between the Center and High Break keys. For normal key track, use positive values.

**High-Top** [-Inf, -99...+99, +Inf]

This sets the slope between the High Break key and the top of the MIDI note range. For normal key track, use positive values.

---

## 6–2b: Amp Modulation

You can modulate the Amp level by velocity and two AMS sources. Each of the AMS sources also has its own secondary intensity modulation.

This modulation scales the basic Amp level and Amp EG level parameters. If these original levels are low, the maximum volume available with modulation will also be reduced.

Note that there is an upper limit to Amp modulation. Once the volume level reaches double the programmed Amp Level and Amp EG level settings, it cannot be increased any further.

**Velocity Intensity** [-99...+99]

With **positive (+)** values, the volume will increase as you play harder.

With **negative (-)** values, the volume will decrease as you play harder.

**AMS1** [List of AMS Sources]

This selects the first modulation source for the Amp level. For a list of AMS sources, see “Alternate Modulation Source (AMS) List” on page 1091.

**Intensity** [-99...+99]

This sets the initial amount of **AMS1**. The **Intensity Mod AMS** then adds to this initial amount.

**Intensity Mod AMS** [List of AMS Sources]

This selects a secondary AMS modulation source to scale the intensity of **AMS1**.

For a list of AMS sources, see “Alternate Modulation Source (AMS) List” on page 1091.

**Intensity** [-99...+99]

This controls the depth and direction of the **Intensity Mod AMS**. Even if the main **AMS1 Intensity** is set to 0, **Intensity Mod AMS** can still control the final amount of **AMS A** over the full +/-99 range.

For example, if **AMS1** is set to **LFO1**, and **Intensity Mod AMS** is set to **After Touch**, **positive** settings mean that aftertouch will increase the amount of LFO modulation.

**AMS2** [List of AMS Sources]

This selects a second modulation source for the Amp level. For a list of AMS sources, see “Alternate Modulation Source (AMS) List” on page 1091.

**Intensity** [-99...+99]

This sets the initial amount of **AMS2**. The **Intensity Mod AMS** then adds to this initial amount.

**Intensity Mod AMS** [List of AMS Sources]

This selects a secondary AMS modulation source to scale the intensity of **AMS2**.

For a list of AMS sources, see “Alternate Modulation Source (AMS) List” on page 1091.

**Intensity** [-99...+99]

This controls the depth and direction of the **Intensity Mod AMS**. Even if the main **AMS2 Intensity** is set to 0, **Intensity Mod AMS** can still control the final amount of **AMS A** over the full +/-99 range.

---

## ▼ 6–2: Page Menu Commands

The number before each command shows its ENTER + number-key shortcut. For more information on these shortcuts, see “ENTER + 0-9: shortcuts for menu commands” on page 147.

- **0: Write Program.** For more information, see “Write Program” on page 147.
- **1: Exclusive Solo.** For more information, see “Exclusive Solo” on page 147.



## 6-3: Amp EG AMSSource

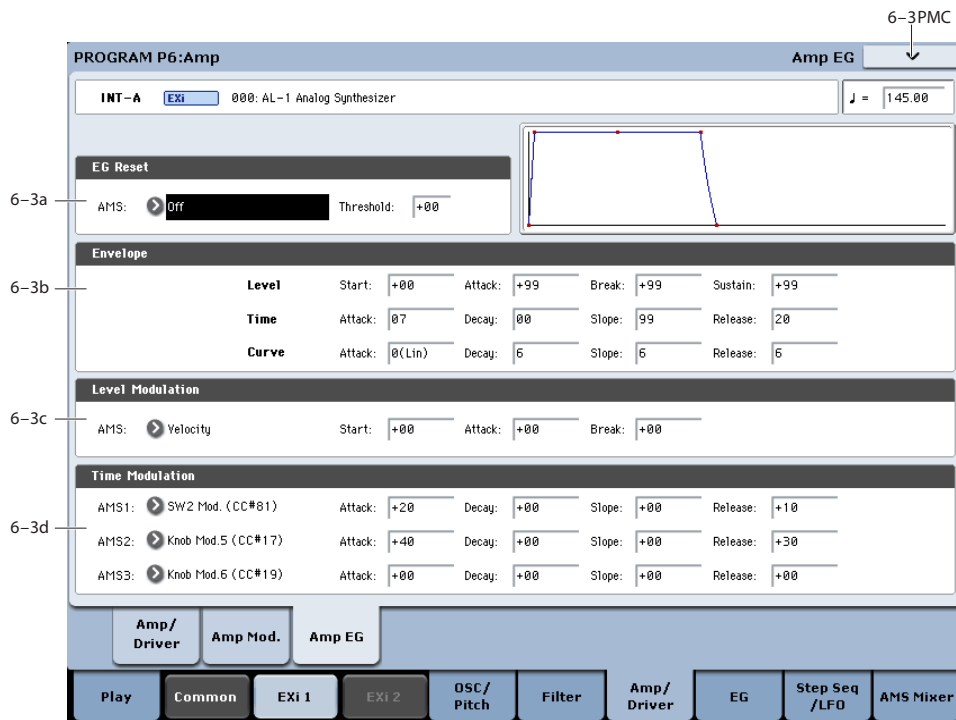

The AL-1's Amp EG is identical to the HD-1's. For more detailed explanations of the Amp EG features, please see "4-3: Amp1 EG," on page 87.

Other envelopes can be used as additional controls via AMS, if desired.

### 6-3a: EG Reset

#### AMS [List of AMS Sources]

This selects an AMS source to reset the EG to the start point. For instance, you can use a tempo-synced LFO to trigger the EG in a repeating rhythm. This reset is in addition to the initial note-on, which always causes the EG to start.

Note: Once the Amp EG is in its Release segment, it cannot be reset. (Otherwise, the sound might keep playing forever!)

For a list of AMS sources, see "Alternate Modulation Source (AMS) List" on page 1091.

#### Threshold [-99...+99]

This sets the AMS level which will trigger the EG reset. Among other things, you can use this to adjust the exact point in an LFO's phase at which the EG will be reset, effectively controlling its "groove" against other rhythmic effects.

When the threshold is **positive**, the EG triggers when passing through the threshold moving upwards. When the threshold is **negative**, the EG triggers when passing through the threshold moving downwards.

**Note:** with some LFO shapes, and with faster LFO speeds, the LFO may not always reach the extreme values of +99 or -99. In this case, setting the **Threshold** to these values may cause inconsistent behavior, or

may mean that the EG doesn't reset at all. If this happens, reduce the **Threshold** until the EG triggers consistently.

### 6-3b: Amp EG

These parameters specify how the amp EG will change over time.

*Amp EG*

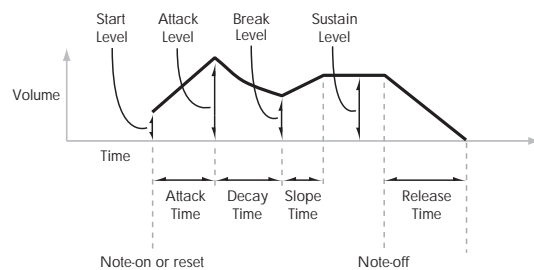

#### Level

##### Start [00...99]

This sets the initial volume level at note-on.

##### Attack [00...99]

This sets the level at the end of the Attack time.

##### Break [00...99]

Break, short for Break Point, sets the level at the end of the Decay time.

##### Sustain [00...99]

This sets the level at the end of the Slope time. Once it reaches the Sustain level, the EG will stay there until note-off (unless it is reset via AMS).

### Time

Higher values mean longer times. For a chart showing equivalents in milliseconds, please see “Time” on page 88.

#### Attack [00...99]

This sets how long the EG takes to move from the Start level to the Attack level.

The minimum attack time is 2/3 of a millisecond—as fast as the most punchy of classic analog synths.

For the fastest possible attack time, you can set the Start level to +99; in this case, the EG will start instantaneously at its maximum value.

#### Decay [00...99]

This sets the time it takes to move from the Attack level to the Break level.

#### Slope [00...99]

This sets how long the EG takes to move from the Break level to the Sustain level. Once it reaches the Sustain level, the EG will stay there until note-off (unless it is reset via AMS).

#### Release [00...99]

This sets how long it takes the EG to move from the Sustain level to silence.

### Curve

Classic analog synth envelopes created curved shapes naturally. The KRONOS goes a step further than vintage synths, however, and lets you control the amount of curvature separately for each of the four envelope segments.

When you change the curvature, the EG times remain the same. However, greater curvature will tend to *sound* faster, because the value changes more quickly at the beginning.

You may find that different amounts of curvature are suitable for segments which go up and segments which go down.

For instance, a curve of 3 is a good default setting for upward segments, such as Attack. On the other hand, a curve of 6 or more is good for downward segments, such as Decay and Release.

#### Attack [0 (Linear), 1...9, 10 (Exp/Log)]

This sets the curvature of the Attack segment - the transition from the Start level to the Attack level.

#### Decay [0 (Linear), 1...9, 10 (Exp/Log)]

This sets the curvature of the Decay segment - the transition from the Attack level to the Break level.

#### Slope [0 (Linear), 1...9, 10 (Exp/Log)]

This sets the curvature of the Slope segment - the transition from the Break level to the Sustain level.

#### Release [0 (Linear), 1...9, 10 (Exp/Log)]

This sets the curvature of the Release segment - the transition from the Sustain level to the Release level.

## 6-3c: Level Modulation

These settings let you use an AMS source to control the Level parameters of the EG. The Start, Attack, and Break levels share a single AMS source, but can each have different modulation intensities.

Note: Once the EG has started a segment between two points, that segment can no longer be modulated. For instance, if the EG is in the middle of the Decay time, you can no longer modulate either the Decay time or the Break level.

This also means that modulating the Start level, Attack level, or Attack time will not affect notes that are already sounding, unless the EG is then reset via AMS.

#### AMS [List of AMS Sources]

This selects an AMS source to control the EG’s Level parameters.

For a list of AMS sources, see “Alternate Modulation Source (AMS) List” on page 1091.

#### Start [-99...+99]

This controls the depth and direction of the AMS modulation for the Start level.

#### Attack [-99...+99]

This controls the depth and direction of the AMS modulation for the Attack level.

#### Break [-99...+99]

This controls the depth and direction of the AMS modulation for the Break level.

## 6-3d: Time Modulation

These settings let you use three different AMS sources to control the Time parameters of the EG. For each of the three AMS sources, the Attack, Decay, Slope, and Release times each have their own modulation intensities.

#### AMS1 [List of AMS Sources]

Selects the first AMS source to control the EG’s Time parameters. Velocity and Keyboard Track can both be useful here, for instance.

For a list of AMS sources, see “Alternate Modulation Source (AMS) List” on page 1091.

#### Attack [-99...+99]

This controls the depth and direction of the AMS modulation for the Attack time.

When the AMS source is at its maximum value—for instance, when Velocity is at 127—a setting of +8 will make the segment time almost twice as long, and a setting of -8 will cut the segment time almost in half.

#### Decay [-99...+99]

This controls the depth and direction of the AMS modulation for the Decay time.

#### Slope [-99...+99]

This controls the depth and direction of the AMS modulation for the Slope time.

**Release** **[-99...+99]**

This controls the depth and direction of the AMS modulation for the Release time.

**AMS2 and AMS3**

These select the second and third AMS sources, respectively, for controlling the EG's Time parameters. Each has its own intensities for Attack, Decay, Slope, and Release. The parameters of both AMS2 and AMS 3 are identical to those of AMS1, above.

---

**▼ 6-3: Page Menu Commands**

The number before each command shows its ENTER + number-key shortcut. For more information on these shortcuts, see "ENTER + 0-9: shortcuts for menu commands" on page 147.

- **0: Write Program.** For more information, see "Write Program" on page 147.
- **1: Exclusive Solo.** For more information, see "Exclusive Solo" on page 147.
- **2: Copy Envelope.** For more information, see "Copy Envelope" on page 224.
- **3: Swap Envelope.** For more information, see "Swap Envelope" on page 224.

## Program P7: EG 1-4

There are four assignable EGs, in addition to the Amp EG. Each of these can be used as an AMS modulation source to control a wide variety of parameters.

There are also four parameters with dedicated EG modulation inputs: Pitch for Oscillators 1 and 2, and Frequency for Filters A and B. Any of the four EGs can be used for these modulation routings.

In the midst of all this flexibility, we thought it would also be good to provide a little structure. With this in mind, EG 1 is named EG 1 (Filter) and EG 2 is labeled EG 2 (Pitch).

Please take these names as suggestions, rather than restrictions. If you like, you're free to use these EGs to control any EG or AMS destination, or to use other EGs to control Filter Frequency and Pitch.

### 7-1: EG 1 (Filter) AMSource

The EGs, or Envelope Generators, let you create complex, time-varying changes to AMS-modulatable parameters. The controls on this page specify the shape of the EG. Among other things, you can:

- Create the basic EG shape by setting the levels and times of each segment.
- Control the curvature of each EG segment, for subtle control over the sound of the EG.
- Set up complex modulation of EG levels and times.
- Set up an AMS source, such as an LFO, to restart the EG.

One thing that you can't do on this page is to control how much effect the EG has on the parameters it modulates. To do that, you'll need to adjust the AMS intensities on the pages for the individual parameters.

#### 7-1a: EG Reset

##### AMS

##### [List of AMS Sources]

This selects an AMS source to reset the EG to the start point. For instance, you can use a tempo-synced LFO to trigger the EG in a repeating rhythm. This reset is in addition to the initial note-on, which always causes the EG to start.

For a list of AMS sources, see "Alternate Modulation Source (AMS) List" on page 1091.

##### Threshold

##### [-99...+99]

This sets the AMS level which will trigger the EG reset. Among other things, you can use this to adjust the exact point in an LFO's phase at which the EG will be reset, effectively controlling its "groove" against other rhythmic effects.

When the threshold is **positive**, the EG triggers when passing through the threshold moving upwards. When the threshold is **negative**, the EG triggers when passing through the threshold moving downwards.

**Note:** with some LFO shapes, and with faster LFO speeds, the LFO may not always reach the extreme values of +99 or -99. In this case, setting the **Threshold**

to these values may cause inconsistent behavior, or may mean that the EG doesn't reset at all. If this happens, reduce the **Threshold** until the EG triggers consistently.

**7-1b: Envelope**

EG

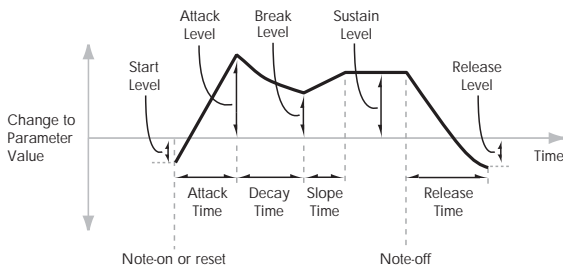

Envelopes create a modulation signal by moving from one level to another over a specified time, and then moving to another level over another period of time, and so on.

The parameters below let you set five levels, the amount of time it takes to go from each of the levels to the next, and the shape (from linear to curved) of each transition.

**Level**

Each of the five levels can be either positive or negative.

**Positive** levels will make the cutoff frequency (or other AMS destination) go up from its programmed value; **negative** levels will make it go down.

**Start** [-99...+99]

This sets the initial EG level, at note-on.

**Attack** [-99...+99]

This sets the level at the end of the Attack time.

**Break** [-99...+99]

Break, short for Break Point, sets the level at the end of the Decay time.

**Sustain** [-99...+99]

This sets the level at the end of the Slope time. Once it reaches the Sustain level, the EG will stay there until note-off, unless it is reset via AMS.

**Release** [-99...+99]

This sets the level at the end of the Release time.

**Time**

Higher values mean longer times, as shown below:

EG Value	Actual Time
00	0.667 ms
10	10 ms
20	44 ms
30	104 ms
40	224 ms
50	464 ms

EG Value	Actual Time
60	944 ms
70	1.8 seconds
80	3.8 seconds
90	10.9 seconds
99	87.3 seconds

**Attack** [00...99]

This sets how long the EG takes to move from the Start level to the Attack level.

The minimum attack time is 2/3 of a millisecond—as fast as the most punchy of classic analog synths.

For the fastest possible attack time, you can set the Start level to +99; in this case, the EG will start instantaneously at its maximum value.

**Decay** [00...99]

This sets the time it takes to move from the Attack level to the Break level.

**Slope** [00...99]

This sets how long the EG takes to move from the Break level to the Sustain level. Once it reaches the Sustain level, the EG will stay there until note-off (unless it is reset via AMS).

**Release** [00...99]

This sets how long it takes the EG to move from the Sustain level to the Release level.

**Curve**

For the sake of simplicity, most of the diagrams in this manual show envelopes as being made out of straight lines. In actuality, though, envelopes are more likely to be made out of curves.

In other words, each segment's level will change quickly at first, and then slow down as it approaches the next point. This tends to sound better than straight, linear segments.

Classic analog synth envelopes made these curved shapes naturally. The KRONOS goes a step further than vintage synths, however, and lets you control the amount of curvature separately for each of the four envelope segments.

When you change the curvature, the EG times remain the same. However, greater curvature will tend to *sound* faster, because the value changes more quickly at the beginning.

**Different curve settings for up and down**

You may find that different amounts of curvature are suitable for segments which go up and segments which go down.

For instance, a curve of 3 is a good default setting for upward segments, such as Attack. On the other hand, a curve of 6 or more is good for downward segments, such as Decay and Release.

EG Curve

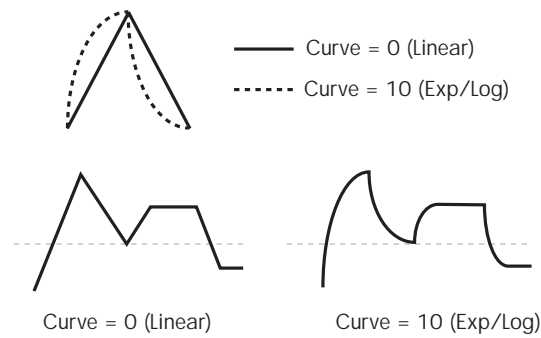

**Attack** [0 (Linear), 1...9, 10 (Exp/Log)]

This sets the curvature of the Attack segment - the transition from the Start level to the Attack level.

**Decay** [0 (Linear), 1...9, 10 (Exp/Log)]

This sets the curvature of the Decay segment - the transition from the Attack level to the Break level.

**Slope** [0 (Linear), 1...9, 10 (Exp/Log)]

This sets the curvature of the Slope segment - the transition from the Break level to the Sustain level.

**Release** [0 (Linear), 1...9, 10 (Exp/Log)]

This sets the curvature of the Release segment - the transition from the Sustain level to the Release level.

**7-1c: Level Modulation**

These settings let you use an AMS source to control the Level parameters of the EG. The Start, Attack, and Break levels share a single AMS source, but can each have different modulation intensities.

By using different settings for each of the three levels, you can cause both subtle and dramatic changes to the EG shape, as shown below.

EG Level Modulation

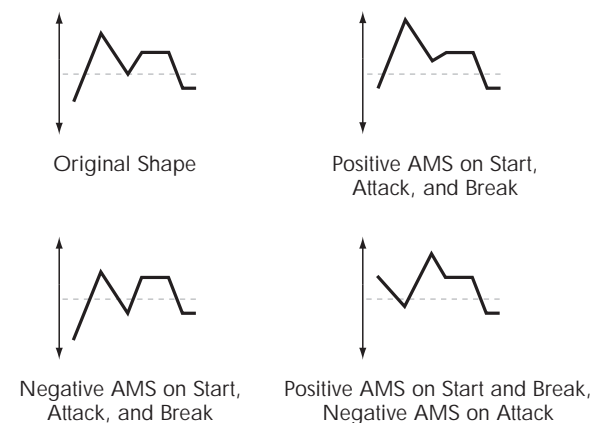

**Once an EG segment begins, it can't be modulated**

Once the EG has started a segment between two points, that segment can no longer be modulated. This includes both the time of the segment, and the level reached at the end of the segment.

For instance, if the EG is in the middle of the Decay time, you can no longer modulate either the Decay time or the Break level.

As another example, let's say that you've assigned the Common LFO to modulate Break Level. The LFO may be moving all the time, but the Break Level is only affected by the LFO's value at the instant that the Decay segment starts. After that, the level is fixed.

Finally, this also means that modulating the Start level, Attack level, or Attack time will not affect notes that are already sounding, unless the EG is then reset via AMS.

**AMS** [List of AMS Sources]

This selects an AMS source to control the EG's Level parameters.

For a list of AMS sources, see "Alternate Modulation Source (AMS) List" on page 1091.

**Start** [-99...+99]

This controls the depth and direction of the AMS modulation for the Start level.

For example, if you set the AMS source to Velocity and set Start to +99, the Start level will increase as you play harder. If you instead set Start to -99, the Start level will decrease as you play harder.

**Attack** [-99...+99]

This controls the depth and direction of the AMS modulation for the Attack level.

**Break** [-99...+99]

This controls the depth and direction of the AMS modulation for the Break level.

**7-1d: Time Modulation**

These settings let you use three different AMS sources to control the Time parameters of the EG. For each of the three AMS sources, the Attack, Decay, Slope, and Release times each have their own modulation intensities.

EG Time Modulation

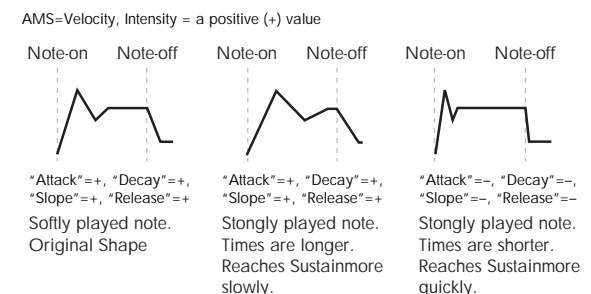

**AMS1** [List of AMS Sources]

Selects the first AMS source to control the EG's Time parameters. Velocity and Keyboard Track can both be useful here, for instance.

For a list of AMS sources, see "Alternate Modulation Source (AMS) List" on page 1091.

**Attack** [-99...+99]

This controls the depth and direction of the AMS modulation for the Attack time.

When the AMS source is at its maximum value—for instance, when Velocity is at 127—a setting of +8 will make the segment time almost twice as long, and a setting of -8 will cut the segment time almost in half.

For example, if you set the AMS source to Velocity and set Attack to +99, the Attack time will get much longer at higher velocities. If you instead set Attack to -99, the Attack time will get much shorter at higher velocities.

**Decay** [-99...+99]

This controls the depth and direction of the AMS modulation for the Decay time.

**Slope** [-99...+99]

This controls the depth and direction of the AMS modulation for the Slope time.

**Release** [-99...+99]

This controls the depth and direction of the AMS modulation for the Release time.

**AMS2 and AMS3**

These select the second and third AMS sources, respectively, for controlling the EG's Time parameters. Each has its own intensities for Attack, Decay, Slope, and Release. The parameters of both AMS2 and AMS3 are identical to those of AMS1, above.

---

▼ **7-1: Page Menu Commands**

The number before each command shows its ENTER + number-key shortcut. For more information on these shortcuts, see "ENTER + 0-9: shortcuts for menu commands" on page 147.

- 0: **Write Program**. For more information, see "Write Program" on page 147.
- 1: **Exclusive Solo**. For more information, see "Exclusive Solo" on page 147.
- 2: **Copy Envelope**. For more information, see "Copy Envelope" on page 224.
- 3: **Swap Envelope**. For more information, see "Swap Envelope" on page 224.

---

**7-2: EG 2 (Pitch)** 

---

**7-3: EG 3** 

---

**7-4: EG 4** 

The settings for EGs 2-4 are identical to those for EG1. For more information, see "7-1: EG 1 (Filter)" on page 211.



# Program P8: Step Seq/LFO

## 8-1: Step Sequencer AMSource

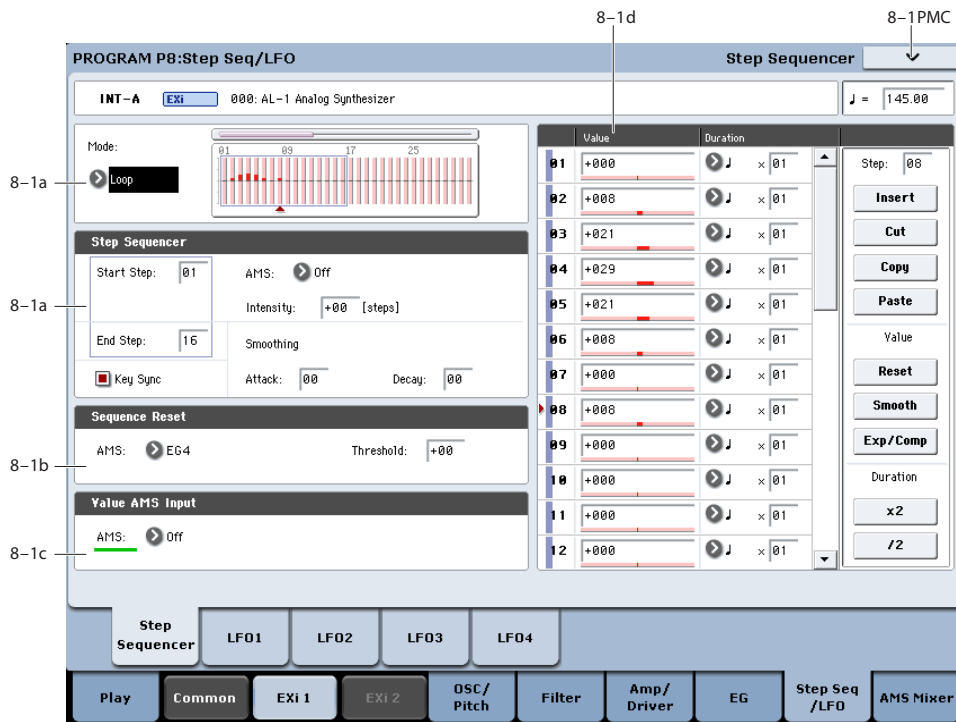

### Overview

The Step Sequencer creates complex, rhythmic patterns, for use as an AMS modulation source. For instance, you can modulate a filter to create sample-and-hold effects, modulate pitch to create melodic patterns, or modulate amplitude to create pulsing, triggered-gate effects.

Each voice of the AL-1 has its own Step Sequencer, in addition to the Common Step Sequencer shared by both EXi instruments. To make all of the per-voice Step Sequencers run in sync, set **Key Sync** to **Off**.

The sequence can have up to 32 steps, each with its own level and duration. It can loop, or play only once. You can also:

- Re-start the Step Sequencer via AMS
- Modulate the Start Step via AMS
- Use individual steps to either gate or do sample-and-hold on a continuous AMS source, such as an EG or LFO
- Assign individual steps to create a random level
- Use Smoothing to create gentle, curving shapes

### Step Sequencer usage tips

For some tips on using the Step Sequencer, see:

- “Creating melodic patterns with the Step Sequencer” on page 177
- “Using Smoothing to create envelope-like shapes” on page 178

- “Using Smoothing to make step transitions more gentle” on page 178

### 8-1a: Step Sequencer

#### Mode [Loop, One Shot]

**Loop** makes the Step Sequence loop continuously between the **Start Step** and the **End Step**.

**One Shot** makes the Step Sequence play once from the **Start Step** to the **End Step**, and then hold at the **End Step**. You can still reset the Step Sequencer from AMS to make it play again.

#### Start Step [1...32]

This is the step on which the sequence will start. If **Mode** is set to **Loop**, this also sets the start of the loop.

#### AMS [List of AMS Sources]

This selects an AMS source to modulate the **Start Step**. For a list of AMS sources, see “Alternate Modulation Source (AMS) List” on page 1091.

#### Intensity [-32...+32]

This controls the depth and direction of the **Start Step** modulation.

#### End Step [01...32]

This sets the last step in the sequence. Once the sequence reaches the **End Step**, it will either hold there until the note goes away (if **Mode** is set to **One Shot**), or loop back to the **Start Step** (if **Mode** is set to **Loop**).

**Key Sync** [Off, On]

When **Key Sync** is **On**, each note's Step Sequencer is independent, and the sequence always starts from the **Start Step** at note-on.

When **Key Sync** is **Off**, the Step Sequencers for all notes are synchronized together (unless the **Start Step** is modulated by note-specific AMS sources). The first note in a legato phrase will start from the **Start Step**; subsequent notes will play in sync with that first note.

**Smoothing**

These controls filter the Step Sequencer's output signal, creating more gentle transitions between values. You can use this to round off the hard edges of the Step Sequencer's output, or to create envelope-like effects.

You have separate control of the amount of smoothing during the attack (when the signal is increasing) and decay (when it's decreasing).

For more information, see "Using Smoothing to create envelope-like shapes" on page 178, and "Using Smoothing to make step transitions more gentle" on page 178.

**Attack** [00...99]

This controls the attack time of the smoother, or how long it takes to reach a new, *higher* value.

Higher **Attack** settings mean longer times.

Depending on how quickly the Step Sequencer value is changing, high **Attack** settings may mean that a new value is never quite reached.

**Decay** [00...99]

This controls the decay time of the smoother, or how long it takes the smoother to reach a new, *lower* value.

Higher **Decay** settings mean longer times.

**8-1b: Sequencer Reset****AMS** [List of AMS Sources]

This selects an AMS source to reset the sequence to the **Start Step**.

**Threshold** [-99...+99]

This sets the AMS level which will make the Step Sequencer reset. Among other things, you can use this to adjust the exact point in an LFO's phase at which the sequencer will be reset, effectively controlling its "groove" against other rhythmic effects.

When the threshold is **positive**, the Step Sequencer triggers when passing through the threshold moving upwards. When the threshold is **negative**, the Step Sequencer triggers when passing through the threshold moving downwards.

**Note:** with some LFO shapes, and with faster LFO speeds, the LFO may not always reach the extreme values of +99 or -99. In this case, setting the **Threshold** to these values may cause inconsistent behavior, or may mean that the Step Sequencer doesn't reset at all. If this happens, reduce the **Threshold** until the Step Sequencer triggers consistently.

**8-1c: Value AMS Input****AMS** [List of AMS Sources]

This is the AMS source used for steps set to **AMS Input** or **AMS Input S/H**.

**8-1d: Step Parameters**

Each of the 32 steps has its own settings for Value and Duration.

**Value 1-32** [-100...+100, Random, AMS Input, AMS Input S/H]

-100 through +100 generate specific levels, just as you'd expect.

**Random** yields a different, random value every time the step is played.

**AMS Input** uses the signal from the **Value AMS Input** source, above. This can change continuously over the duration of the step. For instance, if you used an LFO as the **Value AMS Input**, you'd hear the LFO move over the duration of the step.

**AMS Input S/H** grabs the level of the **Value AMS Input** source at the start of the step, and then maintains that single value for the duration of the step.

**Duration (Base Note) 1-32** [♪...]

This sets the basic length of the step, relative to the system tempo. The values range from a 32nd note to a whole note, including triplets.

**x (Multiply Base Note by...) 1-32** [01...32]

This multiplies the length of the Base Note. For instance, if the Base Note is set to a sixteenth note, and Times is set to 3, the step's duration will be a dotted eighth note.

**Command buttons****Step****Step** [01...32]

Selects the step that you want to edit.

**Insert**

Inserts the cut or copied step at the current step.

**Cut**

Cuts the current step. Subsequent steps will be moved forward. If desired, you can then paste or insert the cut step into another location.

**Copy**

Copies the current step. You can then paste or insert the copied step into another location.

**Paste**

Pastes the cut or copied step onto the current step, replacing it.

**Value****Reset**

Resets the "Value" of each step to 000.

**Smooth**

Automatically adjusts the “Value” of each step so that they are smoothly connected.

**Exp/Comp**

When you press the Exp/Comp button, the Step Sequence Value dialog box will appear. The value of each step will be expanded or compressed by the percentage (%) you specify.

*Step Sequence Value dialog box*

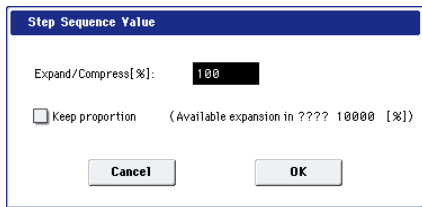

**Expand/Compress [%] [0...100]**

If this is at 100%, the current value of each step will be used without change. If you check “Keep Proportion,” the % value will be limited so that the expansion/compression will maintain the relationships between the current step settings.

**Duration**

**x2**

This doubles the duration of the steps or the “x (Multiply Base Note by...)” value. For example, it would turn eighth notes into quarter notes, and quarter notes into half notes.

**/2**

This halves the duration of the steps or the “x (Multiply Base Note by...)” value. For example, it would turn quarter notes into eighth notes, and eighth notes into sixteenth notes.

**▼ 8-1: Page Menu Commands**

The number before each command shows its ENTER + number-key shortcut. For more information on these shortcuts, see “ENTER + 0-9: shortcuts for menu commands” on page 147.

- 0: **Write Program.** For more information, see “Write Program” on page 147.
- 1: **Exclusive Solo.** For more information, see “Exclusive Solo” on page 147.
- 2: **Copy Step Sequencer.** For more information, see “Copy Step Sequencer” on page 181.

**8-2: LFO 1** AMSource

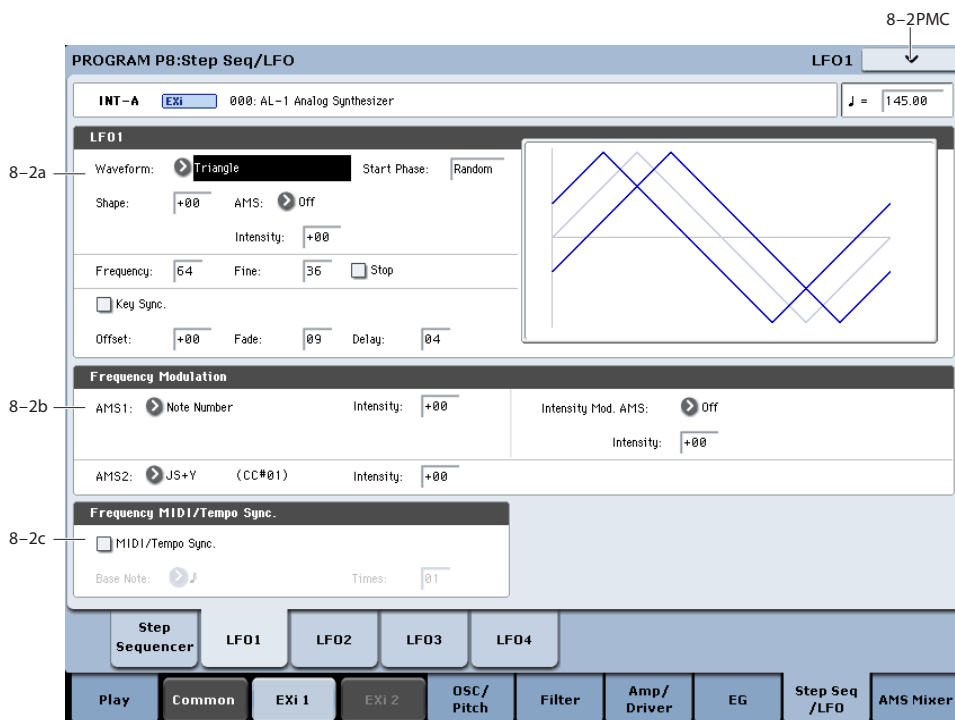

This page has all of the controls for the first LFO. For instance, you can:

- Select the LFO’s basic waveform, and modify it with the Shape parameter.
- Control the LFO’s frequency, and assign AMS controllers to modulate the frequency.

- Use the Key Sync parameter to choose whether the LFO runs separately for each voice, or is synchronized across all of the voices
- Use the Fade and Delay parameters to control how long the LFO waits to start after note-on, and whether it starts abruptly or fades in slowly.
- Set the LFO to sync to MIDI tempo.

**8-2a: LFO 1**

**Waveform [Triangle...Random6 (Continuous)]**

This selects the basic LFO waveform, as shown in the graphic below.

Most of the waveforms should be self-explanatory, but a few will benefit from more details:

**Guitar** is intended for guitar vibrato, and its shape is specifically tuned for this purpose. The waveform is positive-only, so that when used for pitch, it will only bend up, and not down.

**Random1 (S/H)** generates traditional sample and hold waveforms, in which the level changes randomly at fixed intervals of time.

**Random2 (S/H)** randomizes both the levels and the timing.

**Random3 (S/H)** generates a pulse wave with random timing. It's the opposite of traditional sample and hold; the timing varies, but the levels don't.

**Random4-6 (Continuous)** are smoothed versions of Random 1-3, with ramps instead of steps. You can use them to create more gentle random variations.

**Start Phase [-180...+180, Random]**

This controls the phase of the waveform at the start of the note, in steps of 5 degrees.

If **Key Sync** is On, the Start Phase will apply only to the first note of the phrase.

**Shape [-99...+99]**

Shape adds curvature to the basic waveform. As you can see in the graphic below, this can make the waveforms either more rounded or more extreme. It can also be useful to emphasize certain value ranges, and de-emphasize others.

For example, let's say that you are using a triangle LFO to modulate filter cutoff. If Shape emphasizes the high value range, the filter will spend more time at the higher frequencies. If it emphasizes the low range, the filter will spend more time at the lower frequencies.

LFO Shape

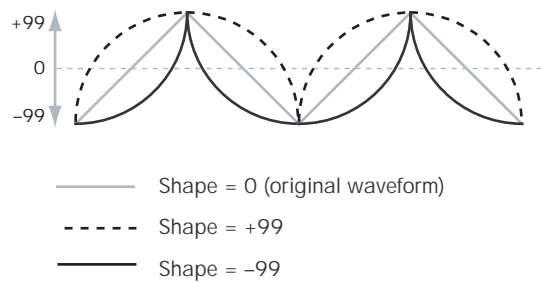

**Note:** Shape does **not** affect the Square and Random 3 waveforms, since their values are always either +99 or -99. When these are selected, Shape is grayed out.

**AMS [List of AMS Sources]**

This selects a modulation source for controlling the LFO's Shape. Modulating the shape can dramatically alter the effect of the LFO—try it out!

For a list of AMS sources, see "Alternate Modulation Source (AMS) List" on page 1091.

**Intensity [-99...+99]**

This controls the depth and direction of the modulation.

**Frequency [00...99]**

This controls the speed of the LFO, before any modulation. Higher values mean faster speeds, as shown in the table below.

By using AMS modulation, you can also get speeds much faster and much slower than are available through this basic setting.

Frequency Value	Frequency in Hz
00	0.014 Hz
10	0.112 Hz
20	0.422 Hz
30	0.979 Hz
40	1.79 Hz
50	2.84 Hz
60	4.14 Hz
70	5.69 Hz
80	7.49 Hz
90	9.53 Hz
99	26.25 Hz
99 + Fine 99	32 Hz

LFO Waveforms

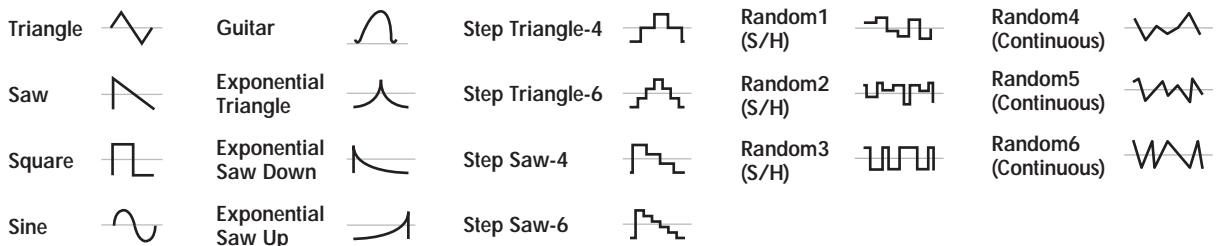

**Frequency Fine** [00...99]

This allows you to control the LFO frequency with greater precision, giving you 98 additional steps for each step of the main Frequency parameter.

When this is set to 00, the LFO speed is as set by the Frequency parameter.

When this is set to 99, it's the same as increasing the main Frequency value by 1.

**Stop** [Off, On]

**On (checked):** When Stop is **On**, the LFO does not advance normally, and the Frequency parameters are ignored. Instead, the LFO simply generate its very first value (as determined by the combination of the **Waveform**, **Start Phase**, **Shape**, and **Offset**), and then holds that value until the end of the note.

You can use this in conjunction with the Random waveforms to create static, random modulation, with the value changing only at note-on.

**Off (unchecked):** When Stop is **Off**, the LFO will function normally.

**Key Sync** [Off, On]

**On (checked):** When Key Sync is **On**, the LFO starts each time you press a key, and an independent LFO runs for each note. This is the normal setting.

**Off (unchecked):** When Key Sync is **Off**, the LFO starts from the phase determined by the first note in the phrase, so that the LFOs for all notes being held are synchronized together. The Fade and Delay settings will only apply to the first note's LFO.

Note that even if Key Sync is Off, each note's LFO speed may still be different if you modulate the Frequency by note number, velocity, key scaling, or other note-specific AMS sources.

**Offset** [-99...+99]

By default, almost all of the LFO waveforms are centered around 0, and then swing all the way from -99 to +99. This parameter lets you shift the LFO up and down, so that—for instance—it's centered on 50, and then swings from -49 to +149.

For example, let's say that you're using an LFO for vibrato. If the Offset is 0, the vibrato will be centered on the note's original pitch, bending it both up and down.

If the Offset is +99, on the other hand, the vibrato will only raise the pitch above the original note.

*Offset settings and pitch change produced by vibrato*

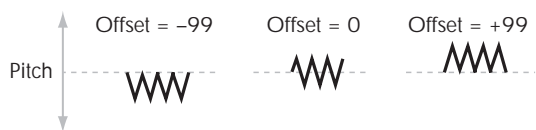

The one exception to this is the Guitar waveform, which is designed to emulate bending a string on a guitar—so that the pitch only goes up, and not down. Because of this, the waveform is centered on 50, and not on 0. Of course, you can always use a negative Offset to shift it back down below 0 again!

Since Offset affects the output values of the LFO, it's important to note that it affects the signal *after* the Shape function, as shown below:

*LFO Signal Flow*

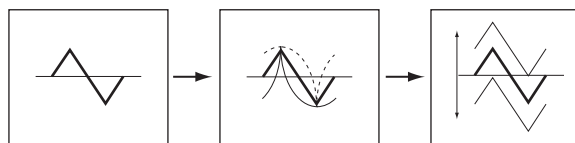

**Fade** [00...99]

The LFO can fade in gradually, instead of simply starting immediately at full strength. This parameter specifies the time from when the LFO begins to play until it reaches its maximum amplitude.

If the Delay parameter is being used, then the fade will begin after the delay is complete.

When **Key Sync** is **Off**, the fade will apply only to the first note in the phrase.

*LFO Fade and Delay*

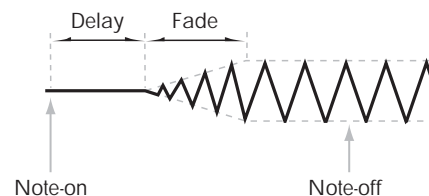

**Delay** [0...99]

This sets the time from note-on until the LFO starts.

When **Key Sync** is **Off**, the delay applies only to the first note of the phrase.

**8-2b: Frequency Modulation**

You can use two alternate modulation sources (AMS) to adjust the speed of the LFO.

**AMS1** [List of AMS Sources]

This selects the first modulation source for the LFO frequency. For a list of AMS sources, see "Alternate Modulation Source (AMS) List" on page 1091.

Note that you can use LFO2 to modulate LFO1's frequency.

**Intensity** [-99...+99]

This sets the initial amount of AMS1. The Intensity Mod AMS then adds to this initial amount.

When AMS1 is at its maximum value (for instance, when the joystick is pushed all the way up), the AMS affects the frequency as shown below:

Intensity	Change to LFO Frequency	
+99	64x	Faster
+82	32x	
+66	16x	
+49	8x	
+33	4x	
+16	2x	

Intensity	Change to LFO Frequency	
-16	1/2x	Slower
-33	1/4x	
-49	1/8x	
-66	1/16x	
-82	1/32x	
-99	1/64x	

**Intensity Mod AMS** [List of AMS Sources]

This selects a secondary AMS modulation source to scale the intensity of AMS1.

For a list of AMS sources, see “Alternate Modulation Source (AMS) List” on page 1091.

**Intensity** [-99...+99]

This controls the depth and direction of the Intensity Mod AMS. Even if the main AMS1 Intensity is set to 0, Intensity Mod AMS can still control the final amount of AMS A over the full +/-99 range.

For example, if AMS1 is set to the Pitch EG, and Intensity Mod AMS is set to After Touch, positive settings mean that aftertouch will increase the intensity of the Pitch EG modulation of LFO Frequency.

**AMS2** [List of AMS Sources]

This selects the second modulation source for the LFO frequency. For a list of AMS sources, see “Alternate Modulation Source (AMS) List” on page 1091.

**Intensity** [-99...+99]

This controls the amount of modulation from AMS2.

**8-2c: Frequency MIDI/Tempo Sync**

**MIDI/Tempo Sync** [Off, On]

**On (checked):** The LFO will synchronize to the system tempo, as set by either the Tempo knob or MIDI Clock. The LFO speed will be controlled by the **Base Note** and **Multiply** parameters, below. All settings for **Frequency** and **Frequency Modulation** will be ignored.

**Off (unchecked):** The Frequency settings will determine the speed of the LFO, and the tempo settings will have no effect.

**Base Note** [MIDI Note Icon] ... [ ]

This sets the basic speed of the LFO, relative to the system tempo. The values range from a 32nd note to a whole note, including triplets.

**x (Multiply Base Note by...)** [01...32]

This multiplies the length of the Base Note. For instance, if the Base Note is set to a sixteenth note, and Times is set to 3, the LFO will cycle over a dotted eighth note.

**▼ 8-2: Page Menu Commands**

The number before each command shows its ENTER + number-key shortcut. For more information on these shortcuts, see “ENTER + 0-9: shortcuts for menu commands” on page 147.

- **0: Write Program.** For more information, see “Write Program” on page 147.
- **1: Exclusive Solo.** For more information, see “Exclusive Solo” on page 147.
- **2: Copy LFO.** For more information, see “Copy LFO” on page 224.
- **3: Swap LFO.** For more information, see “Swap LFO” on page 224.

**8-3: LFO 2** AMSource

**8-4: LFO 3** AMSource

**8-5: LFO 4** AMSource

The settings for LFOs 2-4 are identical to those for LFO1. For more information, see “8-2: LFO 1” on page 217.

## Program P9: AMS Mixer

The AMS Mixers combine two AMS sources into one, or process an AMS source to make it into something new.

For instance, they can add two AMS sources together, or use one AMS source to scale the amount of another. You can also use them to modify the response of realtime controllers.

The AMS Mixer outputs appear in the list of AMS sources, just like other controllers.

This also means that the original, unmodified inputs to the AMS Mixers are still available as well. For instance, if you use Aftertouch as an input to a AMS Mixer, you can use the processed version of the Aftertouch to control one AMS destination, and the original version to control another.

Finally, you can cascade the two AMS Mixers together, by using AMS Mixer 1 as an input to AMS Mixer 2.

### 9-1: AMS Mixer

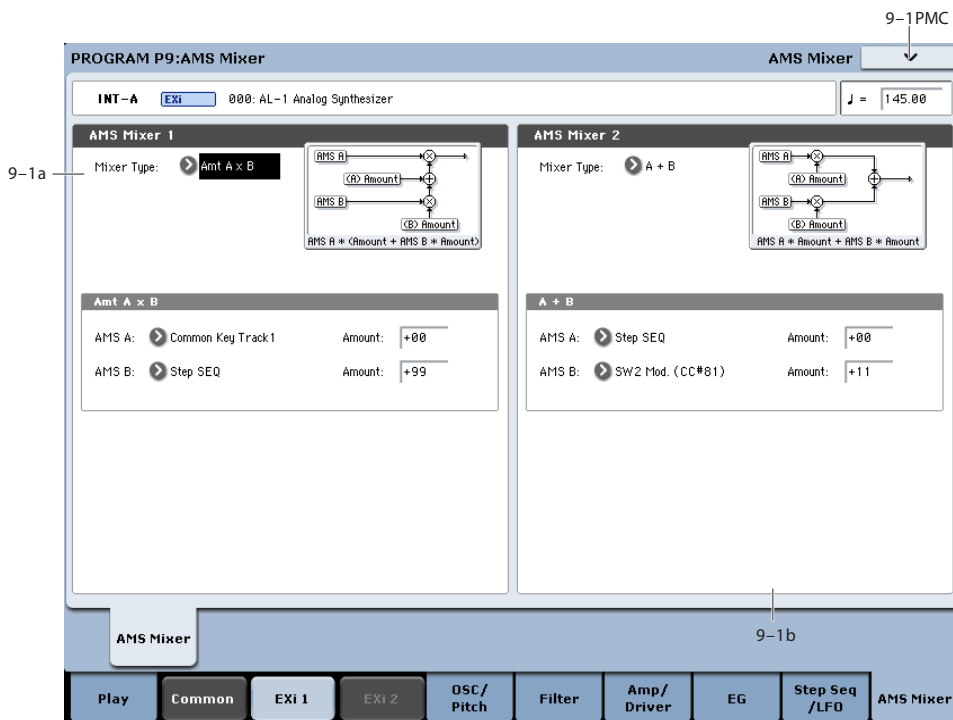

#### 9-1a: AMS Mixer 1 AMSource

**Mixer Type** [A+B, Amt Ax B, Offset, Smoothing, Shape, Quantize, Gate]

This controls the type of processing performed by AMS Mixer 1. Each of the Mixer Types is discussed in detail elsewhere in the manual.

**A+B** adds two AMS sources together. For more information, see “A+B” on page 99.

**Amt Ax B** scales the amount of one AMS source with the other. See “Amt A x B” on page 99 for more details.

**Offset** adds or subtracts a constant value to or from an AMS source. For more information, see “Offset” on page 100.

**Smoothing** creates more gentle transitions between values, smoothing out abrupt changes such as a quick move on a joystick or a sharp edge on an LFO. For details, see “Smoothing” on page 101.

**Shape** adds curvature to the AMS input. For an in-depth description, see “Shape” on page 101.

**Quantize** turns smooth transitions into discrete steps. See “Quantize” on page 102 for more information.

**Gate** chooses between two AMS inputs (or fixed values) based on a third AMS source. See “Gate” on page 103 for more information.

#### 9-1b: AMS Mixer 2 AMSource

This is the second AMS Mixer. Its parameters are exactly the same as those of AMS Mixer 1, above.

### ▼ 9-1: Page Menu Commands

The number before each command shows its ENTER + number-key shortcut. For more information on these shortcuts, see “ENTER + 0-9: shortcuts for menu commands” on page 147.

- 0: **Write Program**. For more information, see “Write Program” on page 147.
- 1: **Exclusive Solo**. For more information, see “Exclusive Solo” on page 147.



## AL-1: Tone Adjust

AL-1 Tone Adjust Default Settings

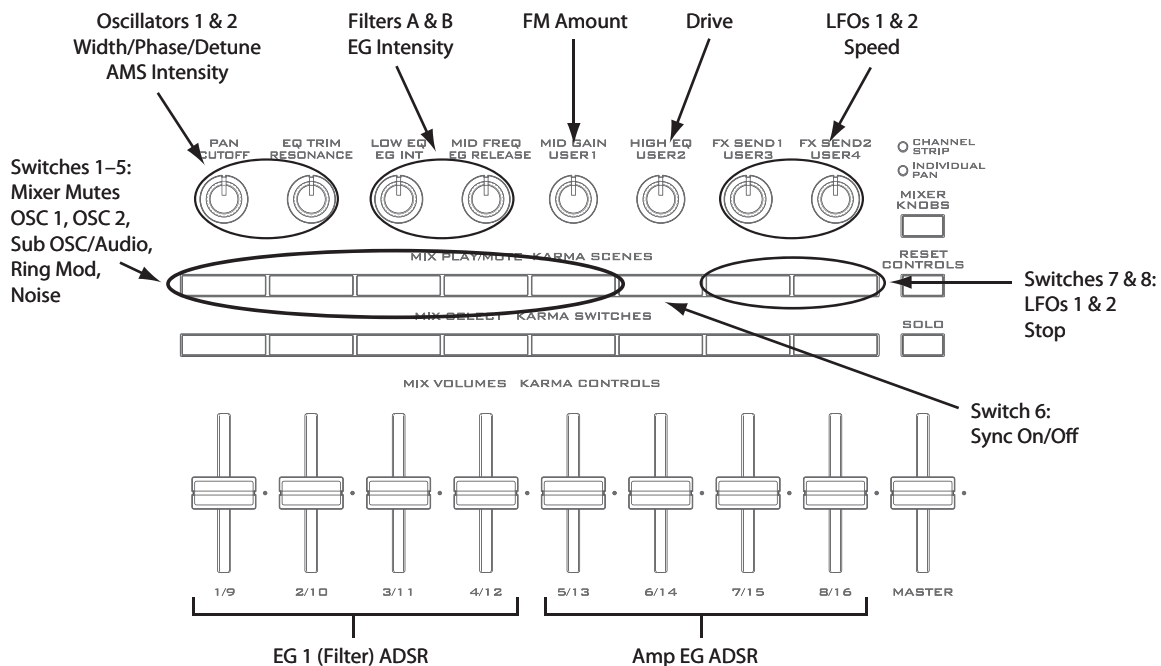

Tone Adjust provides an elegant physical interface to the AL-1's parameters. Most of the factory sounds use the default layout, as shown above. You can also customize the layout for individual sounds, if desired.

For more information about Tone Adjust, please see "0-9f: Tone Adjust," on page 30.

### AL-1 Tone Adjust parameters

The AL-1 supports all of the Common Tone Adjust parameters, as described under "0-9f: Tone Adjust," on page 30. It also adds a number of its own additional parameters, which apply only to the AL-1.

Note that these additional parameters are separate for each EXi, as opposed to being shared by both EXi in the Program.

All of the additional parameters are listed below. Each is marked as either relative (meaning that it scales the existing parameter value) or absolute (which overwrites the existing value).

#### Oscillator 1

- Tune (absolute)
- Waveform (absolute)
- Morph (absolute)
- Morph AMS Intensity (absolute)
- Detune/Pulse Width (absolute)
- Detune/Pulse Width AMS Intensity (absolute)

#### Oscillator 2

Oscillator 2 has the same Tone Adjust parameters as Oscillator 1, above.

#### Oscillators common

- Sync On/Off (absolute)
- FM Amount (absolute)
- FM AMS Intensity (absolute)

#### Mixer

- OSC 1 level (absolute)
- OSC 2 level (absolute)
- Sub OSC/Audio Input level (absolute)
- Ring Mod level (absolute)
- Noise level (absolute)

#### Filter A

In addition to the standard Tone Adjust filter parameters, the AL-1 adds the following:

- Type (absolute)
- Cutoff (absolute)
- Resonance (absolute)
- Frequency EG Intensity (absolute)
- Frequency LFO Intensity (absolute)

#### Filter B

Filter B has the same Tone Adjust parameters as Filter A, above.

#### Amp

- AMS 1 Intensity (absolute)
- AMS 2 Intensity (absolute)
- Drive (absolute)
- Low Boost (absolute)

**EGs**

In addition to supporting the standard Tone Adjust EG parameters, the AL-1 adds the following separate controls for both EG3 and EG4:

- Attack time (relative)
- Decay & Slope time (relative)
- Sustain level (relative)
- Release time (relative)

**LFOs**

In addition to supporting the standard Tone Adjust LFO parameters, the AL-1 adds the following separate controls:

- LFO 3 Speed (relative)
- LFO 3 Fade (relative)
- LFO 3 Delay (relative)
- LFO 3 Stop (absolute)
- LFO 4 Speed (relative)
- LFO 4 Fade (relative)
- LFO 4 Delay (relative)
- LFO 4 Stop (absolute)
- LFO 1, 2, 3, and 4 Waveform (absolute)
- LFO 1, 2, 3, and 4 Shape (absolute)

**Step Sequencer**

In addition to supporting the standard Tone Adjust Common Step Sequencer parameters, the AL-1 adds the following separate control for the per-voice Step Sequencer:

- Smoothing (relative)

**Pitch**

- Pitch Slope (absolute)
- Pitch LFO AMS Intensity (absolute)

## AL-1: Page Menu Commands

### Copy Envelope

This copies settings from one AL-1 envelope to another.

1. Select "Copy Envelope" to open the dialog box.

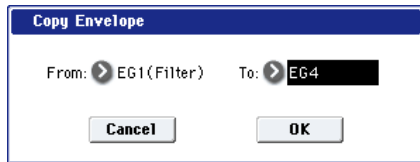

2. Use the "From" field to select the copy-source envelope.
3. Use the "To" field to select the copy-destination envelope.
4. Press the OK button to execute the Copy Envelope operation. If you decide not to execute, press the Cancel button.

### Swap Envelope

This exchanges settings between two AL-1 envelopes.

1. Select "Swap Envelope" to open the dialog box.

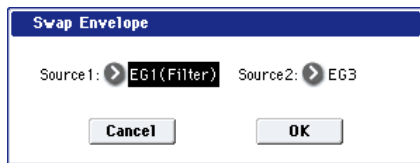

2. Use the "Source 1" and "Source 2" fields to select the two envelopes you want to swap.
3. Press the OK button to execute the Swap Envelope operation. If you decide not to execute, press the Cancel button.

### Copy LFO

This copies settings from one AL-1 LFO to another.

1. Select "Copy LFO" to open the dialog box.

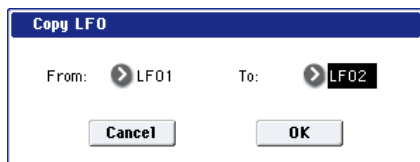

2. Use the "From" field to select the copy-source LFO.
3. Use the "To" field to select the copy-destination LFO.
4. Press the OK button to execute the Copy LFO operation. If you decide not to execute, press the Cancel button.

### Swap LFO

This exchanges settings between two AL-1 LFOs.

1. Select "Swap LFO" to open the dialog box.



2. Use the "Source 1" and "Source 2" fields to select the two LFOs you want to swap.
3. Press the OK button to execute the Swap LFO operation. If you decide not to execute, press the Cancel button.

# EXi: CX-3 Tonewheel Organ

## CX-3 Overview

The CX-3 is a detailed model of a classic tone-wheel organ, based on Korg's ground-breaking CX-3 keyboard.

Its awesome sound starts with perfect tone-wheel phase coherency, resulting in pure, powerful sounding chords, just like the real thing. Subtleties such as different tone wheel types, adjustable overtones, leakage, and noise, along with detailed key-click modeling, provide unparalleled realism.

Amp modeling, Vibrato/Chorus, and Rotary Speaker effects are included in the model, so that you don't need to use any Insert Effects to re-create most classic organ sounds.

In EX mode, you can introduce additional drawbar and percussion harmonics, letting you produce new timbres unavailable on traditional organs.

If you're familiar with the CX-3 keyboard, you might want to check out "Changes from the original CX-3" on page 245 for an overview of some of the improvements in the KRONOS CX-3.

### CX-3 uses EXi fixed resources

The CX-3 uses EXi fixed resources for the built-in rotary speaker, amp, vibrato chorus, and so on. These use up a small amount of processing power, even if you're not playing any notes.

Because of this, you can use a maximum of eight CX-3s simultaneously in a Combination or Song. If other EXi's with fixed resources are in use, the maximum number of CX-3s will be reduced accordingly. Each EXi in each Program counts towards the maximum; for instance, a Program with two CX-3s counts as two, not as one.

On the other hand, once a CX-3 is running, each additional note you play takes up only a small amount of additional power—allowing up to 200 notes of polyphony.

For more information, see "CX-3 & other EXi: Limitations on EXi fixed resources" on page 420.

### Unsupported EXi Common parameters

The CX-3 supports most of the EXi Common parameters except for scales and a number of the voice allocation options, as detailed below:

- **Single Trigger** (CX-3 always acts as if this was On)
- **Poly Legato**
- **Mono Legato** (simple Mono retrigger mode is supported, however)
- **Mono Mode** (Normal or Use Legato Offset)
- **Unison**, including **Number of Voices**, **Detune**, and **Thickness**
- **Scale**, including **Type**, **Key**, and **Random**

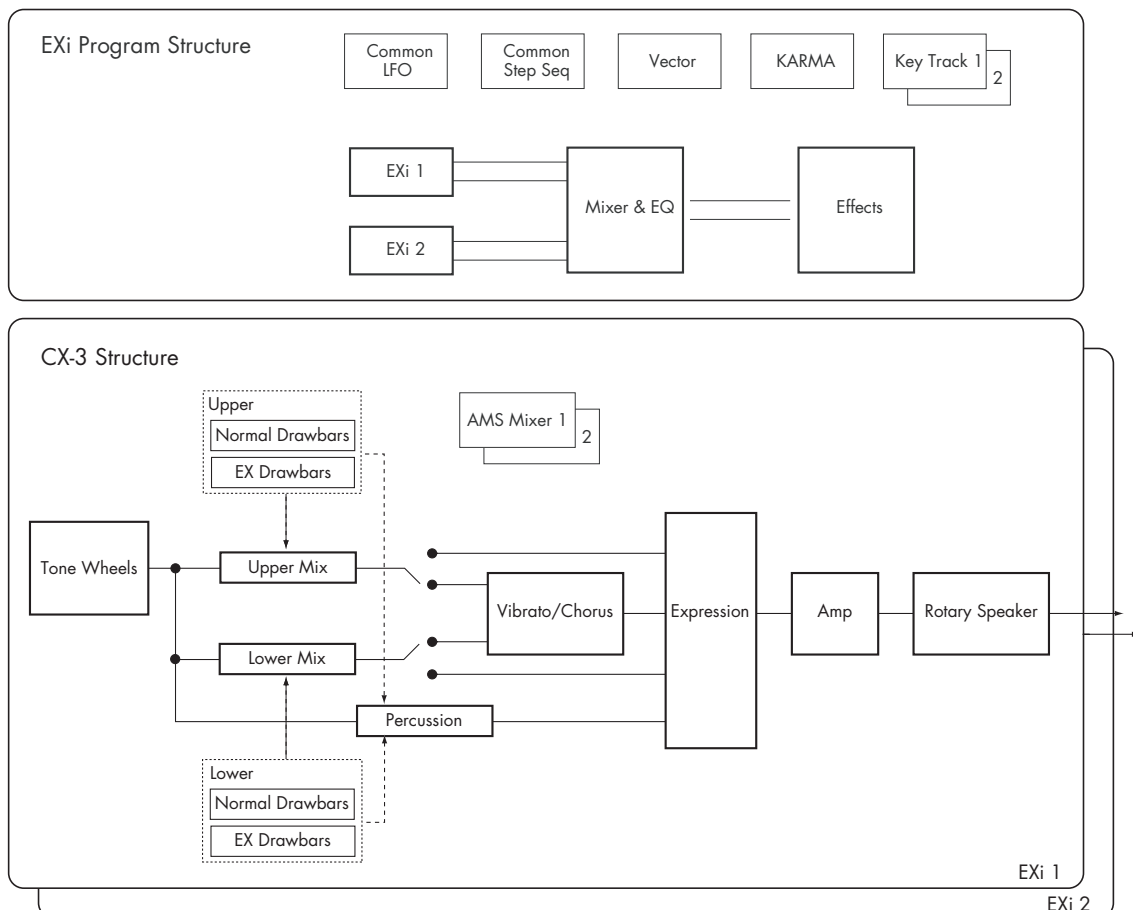

## EXi Program P0: Play

### 0-1: Main

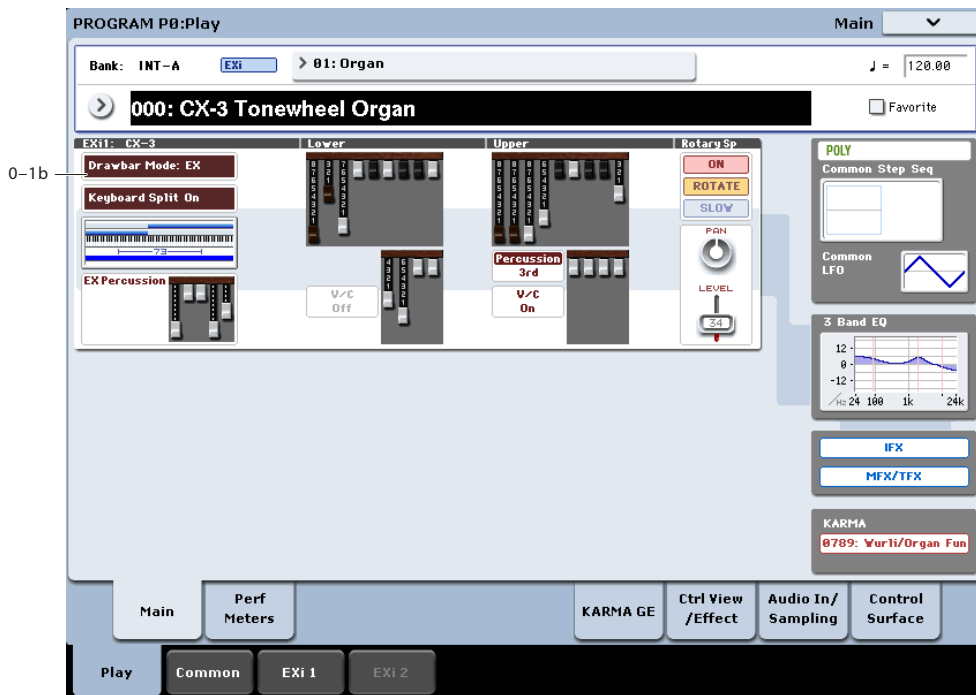

This is the main page of Program mode. For a full description of this page and all of its functions, please see “EXi Program P0: Play” on page 165. This section describes only the overview display, which differs for each individual EXi.

#### 0-1b: Overview and Page Jump

This part of the page shows an overview of the most important settings for the Program’s two EXi instruments. The specific parameters will vary, depending on which EXi are being used. The specific parameters for the AL-1 are described below.

The graphics give you a quick way to check all of these settings at a glance. They also let you jump instantly to any of the displayed parameters. Just touch one of the graphics, and you’ll jump to the page containing its parameters. For instance, if you touch the Filter EG graphic, you’ll go to the Filter EG page.

*Tip:* Pressing EXIT several times will always bring you back to this page.

#### Display shows programmed values—not AMS

These graphics show the values of the programmed parameters, including any edits made via Tone Adjust. They do not update to show temporary changes made by AMS modulation.

For instance, moving the joystick up (JS+Y) will often switch the Rotary Speaker between fast and slow, via AMS. You’ll hear the sound change - but since the programmed parameter is still the same, the display won’t be updated.

### CX-3

#### Drawbar Mode

This shows whether the Drawbars are set to Normal or EX modes.

Press this area to jump to the Basic page.

#### Keyboard Split

This shows whether the Keyboard Split is turned on, or turned off.

Press this area to jump to the Keyboard Split page.

#### Keyboard Split Zone/Common Key Zone

The upper portion of this graphic shows the keyboard split range within the CX-3.

Press this area to jump to the Keyboard Split page.

The lower portion shows the key zones for EXi1 and EXi2, as set on the Common section’s Program Basic page, in relation to the entire MIDI note range. The range of the 61-, 73-, or 88-note keyboard is also shown, as appropriate.

Press this area to jump to the Program Basic page.

#### EX Percussion

This area shows the EX Percussion settings. It will only appear if the **Drawbar Mode** is set to EX.

Press this area to jump to the EX Percussion page.

**Lower**

These graphics will only be displayed if **Keyboard Split** is turned On.

**Lower Drawbars**

This shows the Lower drawbar settings.

Press this area to jump to the Drawbars page.

**V/C On/Off**

This shows whether the Vibrato/Chorus is turned on or off for the Lower drawbars.

Press this area to jump to the Amp/Vibrato/Chorus page.

**EX Drawbars**

This area shows the Lower EX drawbar settings. It will only appear if the **Drawbar Mode** is set to EX.

Press this area to jump to the EX Drawbars page.

**Upper****Upper Drawbars**

This shows the Upper drawbar settings.

Press this area to jump to the Drawbars page.

**Percussion**

This section shows the **Percussion Harmonic** setting, and whether or not **Percussion** is turned On.

Press this area to jump to the Percussion page.

**V/C On/Off**

This shows whether the Vibrato/Chorus is turned on or off for the Upper drawbars.

Press this area to jump to the Amp/Vibrato/Chorus page.

**EX Drawbars**

This shows the Upper EX drawbar settings.

Press this area to jump to the EX Drawbars page.

**Rotary Speaker**

Press anywhere in this area to jump to the Rotary Speaker page.

**Rotary Speaker On/Off**

This shows the **On/Off** setting of the rotary speaker.

**Mode Switch**

This shows the rotary speaker's **Mode Switch** (Rotate/Stop) setting of the rotary speaker.

**Speed Switch**

This shows the rotary speaker's **Speed Switch** setting (Fast/Slow).

**Common**

The graphics along the right side of the screen show the most important Common parameters, which are shared by both EXi in the Program. This section will always show the same parameters, regardless of which EXi are being used.

**Common Voice Assign Mode**

This shows the voice assign mode of the Program—either POLY or MONO.

Press this area to jump to the Program Basic page.

**Common Step Sequencer**

This shows a graphic overview of the Common Step Sequencer.

Press this area to jump to the Common Step Sequencer page.

**Common LFO Graphic**

This shows the waveform of the Common LFO.

Press this area to jump to the Common LFO page.

**3 Band EQ Graphic**

This shows the mid-sweepable 3-band EQ.

Press this area to jump to the EQ page.

**IFX, MFX/TFX**

Press the IFX area to jump to the IFX Routing page.

Press the MFX/TFX area to jump to the MFX Routing page.

**KARMA GE Name**

This shows the name of the selected KARMA GE.

Press this area to jump to the GE Setup/Key Zones page.

## Program P4: Basic

### 4-1: Basic

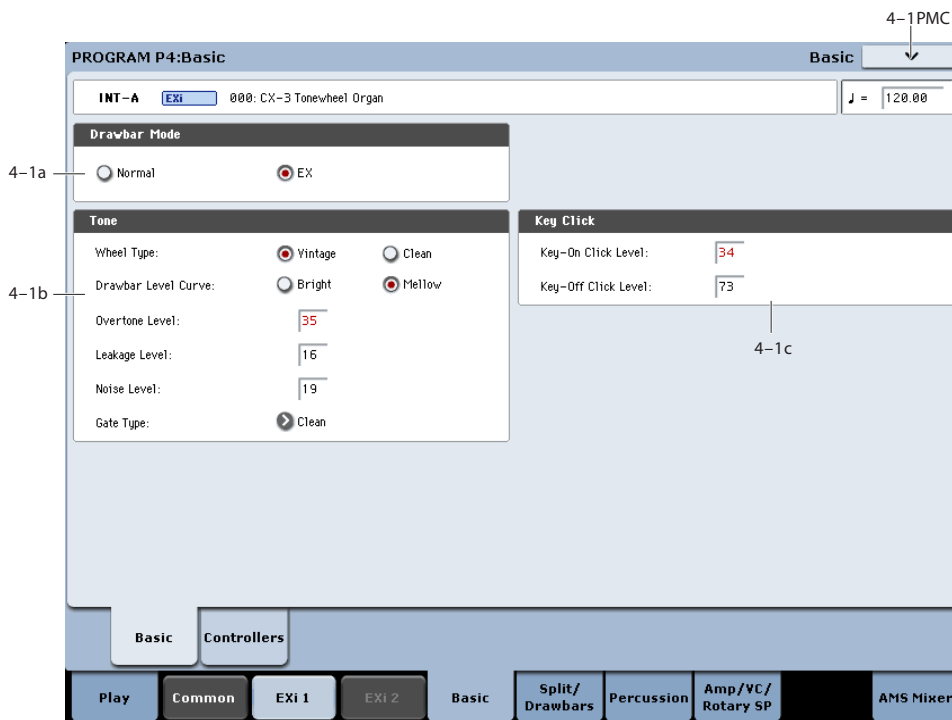

#### 4-1a: Drawbar Mode

##### Drawbar Mode [Normal, EX]

This is a basic control, which affects the parameters available in the Drawbars and Percussion sections.

**Normal** mode models a standard tone-wheel organ, with 9 drawbars and single-pitch percussion.

**EX** mode adds four additional drawbars, with pitches adjustable in half-step increments between 16' and two octaves above 1'. It also allows you to create the percussion using up to five different pitches, each with adjustable volume levels.

#### 4-1b: Tone

##### Wheel Type [Vintage, Clean]

**Vintage** offers an organic, complex tone. It includes some amount of additional harmonics for each note, which can be further increased by using the **Overtone Level** parameter, below. It also adds "leakage," a pitched noise caused by the mix of all 91 tone wheels "leaking" into each individual note—a characteristic part of the authentic tone-wheel organ sound. The **Leakage Level** parameter, below, controls the volume of this component.

**Clean** gives you a pristine, perfect set of tone wheels, with no leakage noise. By default, these tone wheels have no additional overtones—but you can add them by using the **Overtone Level** parameter, below.

##### Drawbar Level Curve [Bright, Mellow]

This controls the way in which the tone-wheel levels change in relation to pitch, which contributes to the overall brightness of the sound.

**Bright** produces a crisp effect, slightly brighter than traditional tone-wheel organs.

**Mellow** produces a slightly darker, more traditional tone.

##### Overtone Level [0...99]

This controls the timbre of the individual tone wheels. Increasing the **Overtone Level** adds more harmonics, for a brighter, richer tone.

The **Wheel Type** setting, above, determines both the specific harmonics added and their volume levels.

##### Leakage Level [0...99]

This specifies the amount of drawbar leakage, both into played notes and into the constant noise (see Noise Level, below).

This parameter is available only when the **Wheel Type**, above, is set to **Vintage**. When the **Wheel Type** is set to **Clean**, it is grayed out.

##### Noise Level [0...99]

This lets you add a constant amount of noise to the outputs - just like you might find in older vintage gear. The noise will be present whether or not any notes are being played.



The noise includes both colored broad-band noise and tone wheel leakage. The amount of leakage within the noise is scaled by **Leakage Level**, described above.

**Gate Type** [Clean, Dirty]

This affects the sound character when notes are turned on or off. It is similar in concept to **Key Click**, below, but has a different timbral character.

**Clean** does not add any additional gate noise.

**Dirty** adds a small amount of noise at note-on and note-off, for a small amount of extra punch. You can also use this if you're looking to duplicate the gate timbre of the CX-3 and BX-3.

**4-1c: Key Click**

Pressing down or releasing a key on a tone wheel organ can result in arcing between the contacts, producing a characteristic "Key Click" sound. This section models that effect.

**Key-On Click Level** [0...99]

This controls the amount of click noise at note-on.

**Key-Off Click Level** [0...99]

This controls the level of the click noise at note-off.

**▼ 4-1: Page Menu Commands**

The number before each command shows its ENTER + number-key shortcut. For more information on these shortcuts, see "ENTER + 0-9: shortcuts for menu commands" on page 147.

- 0: **Write Program**. For more information, see "Write Program" on page 147.
- 1: **Exclusive Solo**. For more information, see "Exclusive Solo" on page 147.

**4-2: Controllers**

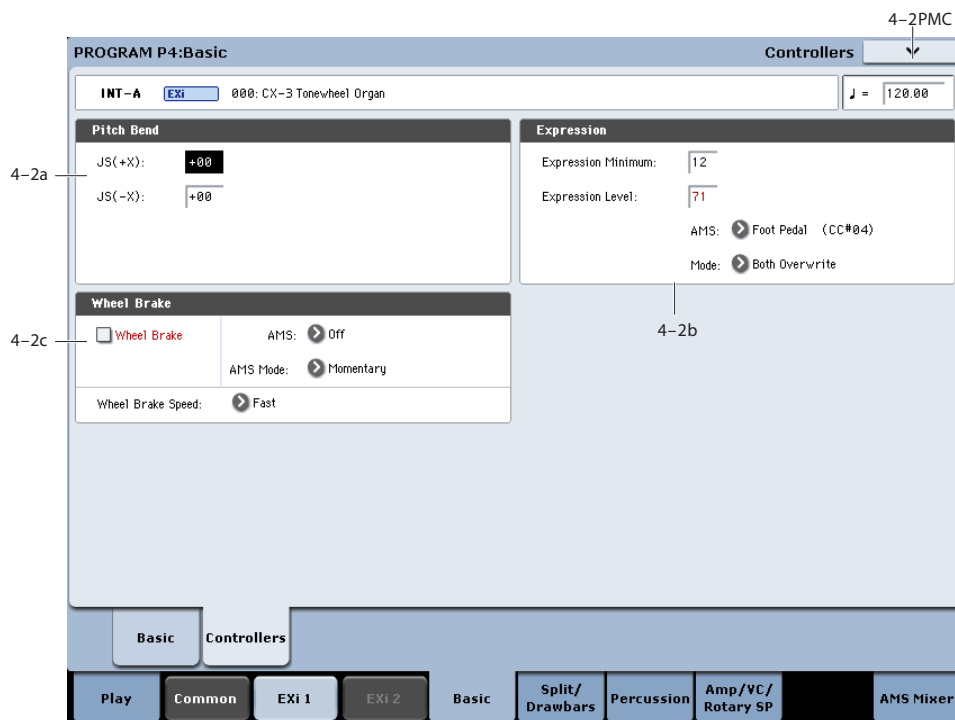

**4-2a: Pitch Bend**

**JS+ X** [-60...+12]

This sets the maximum amount of pitch bend, in semitones, when you move the joystick to the right. For normal pitch bend, set this to a positive value.

For example, if you set this to +12 and move the joystick all the way to the right, the pitch will rise one octave above the original pitch.

**JS- X** [-60...+12]

This sets the maximum amount of pitch bend, in semitones, when you move the joystick to the left. For normal pitch bend, set this to a negative value.

For example, if you set this to -60 and move the joystick all the way to the left, the pitch will fall five octaves below the original pitch.

---

## 4-2b: Expression

Expression adjusts both the volume level and the amount of distortion. At lower Expression values, both the low bass and high treble frequencies are slightly emphasized. The Amp section interacts with Expression; for more details, see “7-1a: Amp,” on page 238.

To allow optimal modulation flexibility, the AMS works differently from most other parameters. See **Mode**, below, for more details.

### Expression Minimum [0...30]

This specifies the minimum level when the Expression Level parameter or Expression AMS are at 0.

### Expression Level [0...99]

This sets the default Expression level. It will be grayed out if the **Mode**, below, is set to **Control Only**.

### AMS [List of AMS Sources]

This selects an AMS source to modulate Expression. For a list of AMS sources, see “Alternate Modulation Source (AMS) List” on page 1091.

This parameter is grayed out if **Mode**, below, is set to **Level Only**.

**NOTE:** The MIDI Expression controller (CC #11) is hard-wired to scale the channel volume level. So, despite the similar name, it’s best to use another controller for as an AMS source.

### Mode [Level Only, AMS Only, Both Scale, Both Overwrite]

This controls how the AMS interacts with the programmed **Expression Level**.

**Level Only:** The **Expression Level** parameter has complete control over Expression. The **AMS** parameter is grayed out and has no affect.

**AMS Only:** The AMS input has complete control over Expression, while the Expression Level parameter is grayed out and has no affect.

**Both Scale:** The values of **Expression Level** and AMS are multiplied to produce the Expression level. For the math-friendly, a value of 99 is treated as 1.0.

**Both Overwrite:** **Expression Level** and **AMS** both write directly to the Expression level. If the **Expression Level** parameter is updated, it directly controls Expression, and the last value from AMS is ignored. If the AMS input moves, it also directly controls Expression, and the setting of the **Expression Level** parameter is ignored.

---

## 4-2c: Wheel Brake

Tone wheel organs actually have physical wheels, which gradually come up to speed when you turn the power on, and gradually slow to a stop when you turn the power off. As the wheels rotate more quickly, the pitch rises; as they slow down, the pitch falls.

This section models this behavior, for use as a special effect.

## Wheel Brake [Off, On]

This parameter allows you to manually control the Wheel Brake. Off is the default; the tone wheels will turn normally. Changing this to On will make the tone wheels gradually slow down, and eventually stop altogether.

### AMS [List of AMS sources]

This selects an AMS source to control the Wheel Brake.

For a list of AMS sources, see “Alternate Modulation Source (AMS) List” on page 1091.

### AMS Mode [Toggle, Momentary]

This parameter controls the way in which the Wheel Brake AMS works.

When this is set to **Toggle**, the Wheel Brake AMS will alternate between “power on” and “power off.” For instance, if **Wheel Brake** is set to **Off**, and **AMS** is assigned to a footswitch, the first press will cause the wheel rotation to slow, and the next press will bring them back up to speed again.

**Momentary** means that the power is turned “off” only while the controller is enabled. Continuing the example from above, when the footswitch is pressed down, the wheel rotation will slow down; when the footswitch is released, the wheel rotation will speed up again.

AMS lets you switch to the opposite of the programmed setting. For instance, if **Wheel Brake** is set to **On** (unlikely but possible!), and the **AMS Mode** is set to **Momentary**, then pressing down on the footswitch would cause the tone wheels to come up to speed.

If you set AMS to use a continuous controller, such as the Joystick, values of 0-63 are as if the switch was off, and values of 64-127 are as if the switch was on.

Finally - note that the assignable switches, **SW1** and **SW2**, can themselves be set to either momentary or toggle modes, and these settings are reflected by the switch LEDs. Individual parameter mode settings, such as the Wheel Brake AMS Mode, do *not* affect the LEDs.

So, if you’re using SW1 or SW2 as the AMS source, it’s best to set the AMS Mode to Momentary, and then just let the switch itself determine the momentary/toggle behavior.

### Wheel Brake Speed [Slow, Fast]

This controls the speed at which the wheels will slow down and speed up.

---

## ▼ 4-2: Page Menu Commands

The number before each command shows its ENTER + number-key shortcut. For more information on these shortcuts, see “ENTER + 0-9: shortcuts for menu commands” on page 147.

- 0: **Write Program**. For more information, see “Write Program” on page 147.
- 1: **Exclusive Solo**. For more information, see “Exclusive Solo” on page 147.

## Program P5: Split & Drawbars

You can set up the organ to use a single sound across the entire keyboard, or to split the keyboard between two different sets of drawbars.

### 5-1: Keyboard Split

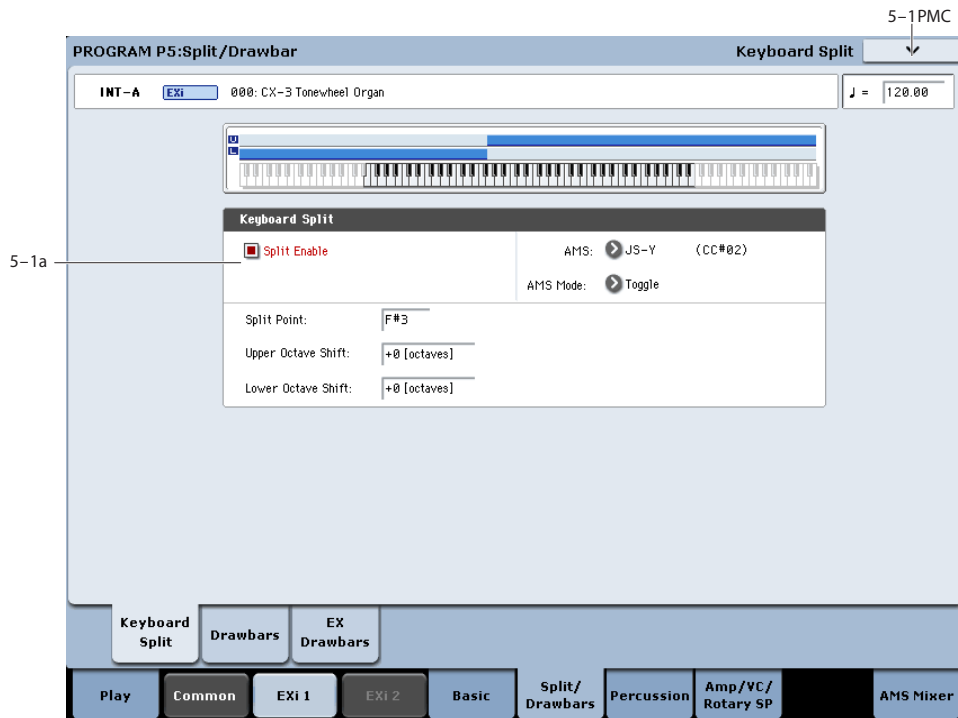

#### 5-1a: Split

##### Split Enable [Off, On]

This turns the split on and off.

When Split is Off, only the Upper drawbars will be used.

##### AMS [List of AMS Sources]

This allows you to assign an AMS source to toggle the split on and off.

For a list of AMS sources, see "Alternate Modulation Source (AMS) List" on page 1091.

##### AMS Mode: [Momentary, Toggle]

This determines the behavior of Split Enable AMS. For details, see "AMS Mode" on page 230.

##### Split Point [C-1...G9]

This sets the highest key of the lower split range.

##### Upper Octave Shift [-2 octaves...+2 octaves]

This raises or lowers the pitch of the Upper drawbars in one-octave steps.

##### Lower Octave Shift [-2 octaves...+2 octaves]

This raises or lowers the pitch of the Lower drawbars in one-octave steps.

#### ▼ 5-1: Page Menu Commands

The number before each command shows its ENTER + number-key shortcut. For more information on these shortcuts, see "ENTER + 0-9: shortcuts for menu commands" on page 147.

- 0: **Write Program**. For more information, see "Write Program" on page 147.
- 1: **Exclusive Solo**. For more information, see "Exclusive Solo" on page 147.

## 5-2: Drawbars

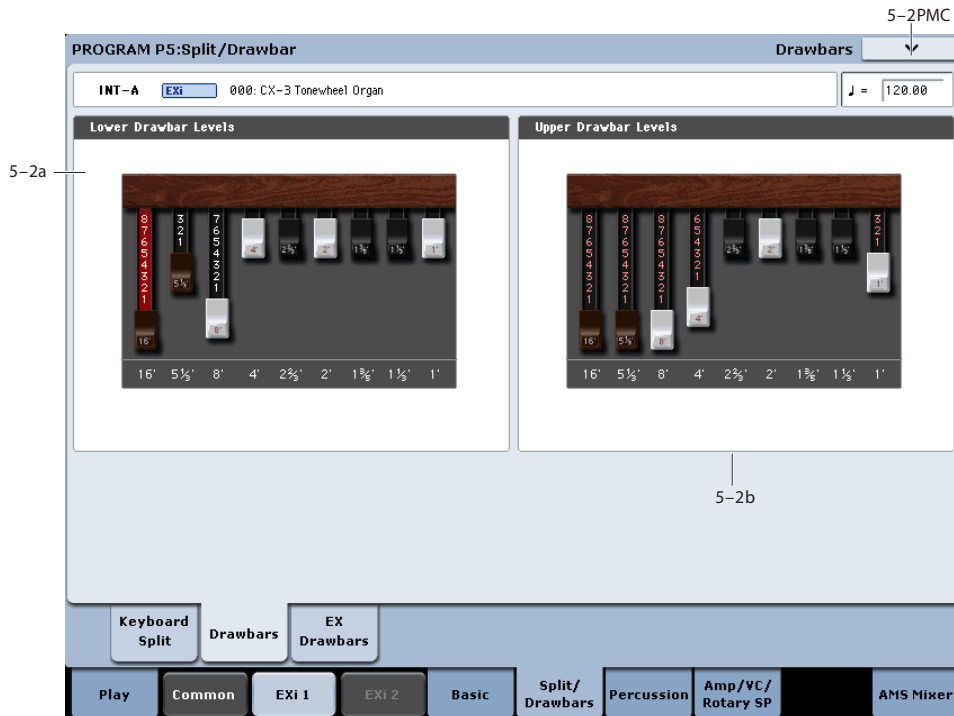

The drawbars are the heart of the CX-3. These settings control the basic harmonic content of the sound, the perceived fundamental pitch, and the basic volume level.

### Use Tone Adjust for physical drawbars

Using Tone Adjust, you can map the drawbars to the nine front-panel sliders, including both sliders 1-8 and the Master slider.

Like traditional tone wheel organs, the throw of the sliders is reversed from that of a mixer: all the way up is 0, and all the way down is the maximum (8).

### Wrap-around

As with traditional organs, the tone wheels produce pitches between C2 and F#8. Depending on the notes that you play, certain drawbar settings may imply pitches outside of this range. In this case, the drawbar pitches will be “wrapped around” by one or more octaves to fit within the available range.

For instance, the 1' drawbar would normally sound 3 octaves above the note that you play. If you play a D6 on the keyboard, this would imply that the 1' play a D9. Since the tone wheels can't play a D9, however, the 1' drawbar is “wrapped around” to the highest possible D - a D8.

The same thing will happen on the low end. For instance, the 16' drawbar normally sounds one octave below the played note. If you play an F1 on the keyboard, this would imply that the 16' sound at F0. Since this is far below the range of the tone wheels, the 16' sounds at its lowest possible F - an F2.

### Interaction between Percussion, 1' drawbar, and EX mode

Percussion can be assigned to either the Upper or Lower split. When the **Drawbar Mode** is set to **Normal**, and percussion is turned on, the 1' drawbar of the split assigned to percussion becomes silent. The other side of the split is not affected.

This models the behavior of the original instruments, in which the 1' bus bar was diverted in order to trigger the percussion.

When the **Drawbar Mode** is set to **EX**, this restriction is removed; the 1' drawbar continues to sound regardless of whether or not percussion is turned on.

### 5-2a: Lower Drawbar Levels

These parameters control the individual drawbar volume levels for the Lower split. The drawbars express their pitches in terms of feet, referring back to pipe organs, in which halving the length of a pipe will raise its pitch by one octave. So, 8' is an octave higher than 16', 4' is an octave higher than 8', and so on.

You can adjust these parameters by using the on-screen drawbar graphics, or use the physical faders via Tone Adjust, as described above.

Note that when **Split** is turned **Off**, only the Upper drawbars are used; the Lower drawbar settings will have no effect.

#### 16'

[0...8]

This is the volume for the lowest drawbar.

0 means that the drawbar will be silent, and 8 is the maximum volume.

**5-1/3', 8', 4', 2-2/3', 2', 1-3/5', 1-1/3', 1'** [0...8]

These set the volume levels for the remaining 8 drawbars.

**5-2b: Upper Drawbar Levels**

These parameters specify the level for each drawbar used by the Upper split. Also, when **Split** is turned **Off**, the Upper drawbars are used for the entire keyboard.

The settings are just the same as for the Lower drawbars. For more details, please see "5-2a: Lower Drawbar Levels," above.

**▼ 5-2: Page Menu Commands**

The number before each command shows its ENTER + number-key shortcut. For more information on these shortcuts, see "ENTER + 0-9: shortcuts for menu commands" on page 147.

- 0: **Write Program**. For more information, see "Write Program" on page 147.
- 1: **Exclusive Solo**. For more information, see "Exclusive Solo" on page 147.

**5-3: EX Drawbars**

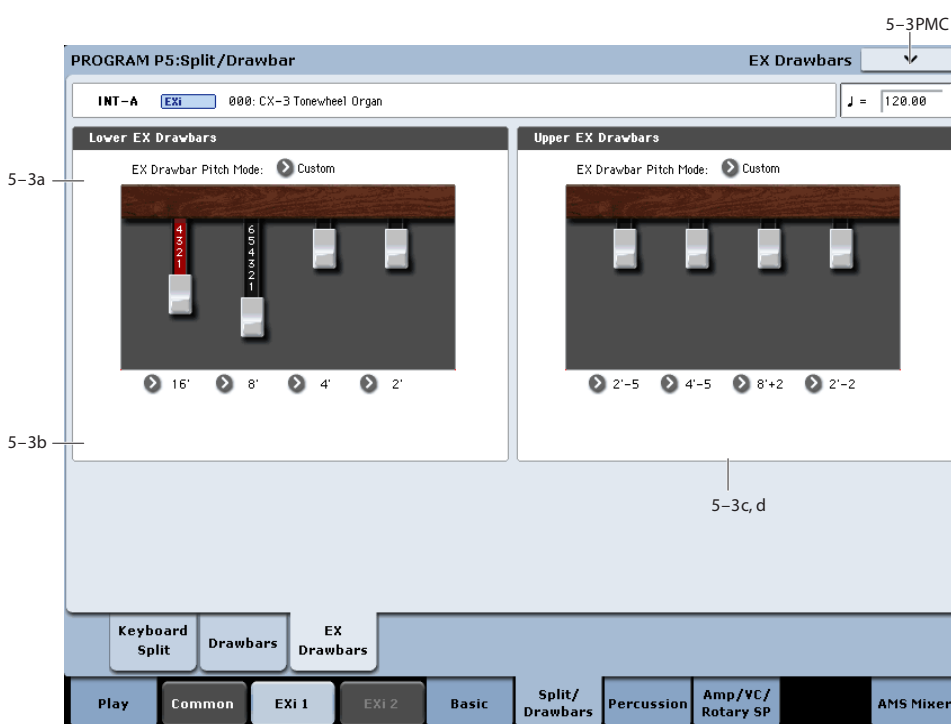

When the **Drawbar Mode** is set to **EX**, this adds four extra drawbars to the basic nine, with pitches adjustable in half-step increments between 16' and two octaves above 1'. You can select from four preset combinations of drawbar pitches, or create your own from scratch.

When the **Drawbar Mode** is set to **Normal**, this section is grayed out.

**Wrap-around and EX mode**

Any harmonics above F#8 are "wrapped around" so that they will sound one or more octaves lower. Similarly, harmonics below C2 will be wrapped around to sound an octave higher. For more details, see "Wrap-around" on page 232.

In particular, this means that high settings of the EX Drawbar 1-4 Pitch parameters, below, may only be perceptible in the lower octaves of the keyboard.

**5-3a: Lower EX Drawbars**

These parameters control the individual EX drawbar pitches and volume levels for the Lower split.

**EX Drawbar Pitch Mode [Preset 1...4, Custom]**

**Presets 1-4** are the CX-3's default Pitch settings for the set of four EX Drawbars. When one of the Presets is selected, the EX Drawbar 1-4 Pitch parameters, below, are grayed out.

**Custom** lets you specify the pitches for each EX drawbar, using the EX Drawbar 1-4 Pitch parameters.

---

### 5-3b: Custom Drawbar Settings

**Ex Drawbar 1 Pitch** [16'...1' +24]

This specifies the pitch assigned to EX Drawbar 1. The values are expressed in organ feet and semitones, with single-semitone steps from 16' to 1' +24 semitones.

This parameter is only available if the **EX Drawbar Mode** is set to **Custom**. Otherwise, it is grayed out.

**Ex Drawbar 1 Level** [0...8]

This is the volume for EX Drawbar 1.

0 means that the drawbar will be silent, and 8 is the maximum volume.

**Ex Drawbars 2-4 Pitch** [16'...1' +24]

These parameters specify the pitch assigned to EX Drawbars 2-4. For more information, see "Ex Drawbar 1 Pitch," above.

**Ex Drawbars 2-4 Level** [0...8]

These parameters specify the volumes of EX Drawbars 2-4. For more information, see "Ex Drawbar 1 Level," above.

---

### 5-3c and 5-3d: Upper EX Drawbars

These parameters control the individual EX drawbar pitches and volume levels for the Upper split. The controls are identical to those for the Lower EX Drawbars, as described above.

---

### ▼ 5-3: Page Menu Commands

The number before each command shows its ENTER + number-key shortcut. For more information on these shortcuts, see "ENTER + 0-9: shortcuts for menu commands" on page 147.

- 0: **Write Program**. For more information, see "Write Program" on page 147.
- 1: **Exclusive Solo**. For more information, see "Exclusive Solo" on page 147.
- 2: **Copy Drawbars**. For more information, see "Copy Drawbars" on page 246.
- 3: **Swap Drawbars**. For more information, see "Swap Drawbars" on page 246.

## Program P6: Percussion

Percussion adds a pitched attack to the notes, for a more crisp, punchy timbre. When you play legato, percussion will only sound for the first note in the phrase.

### 6-1: Percussion

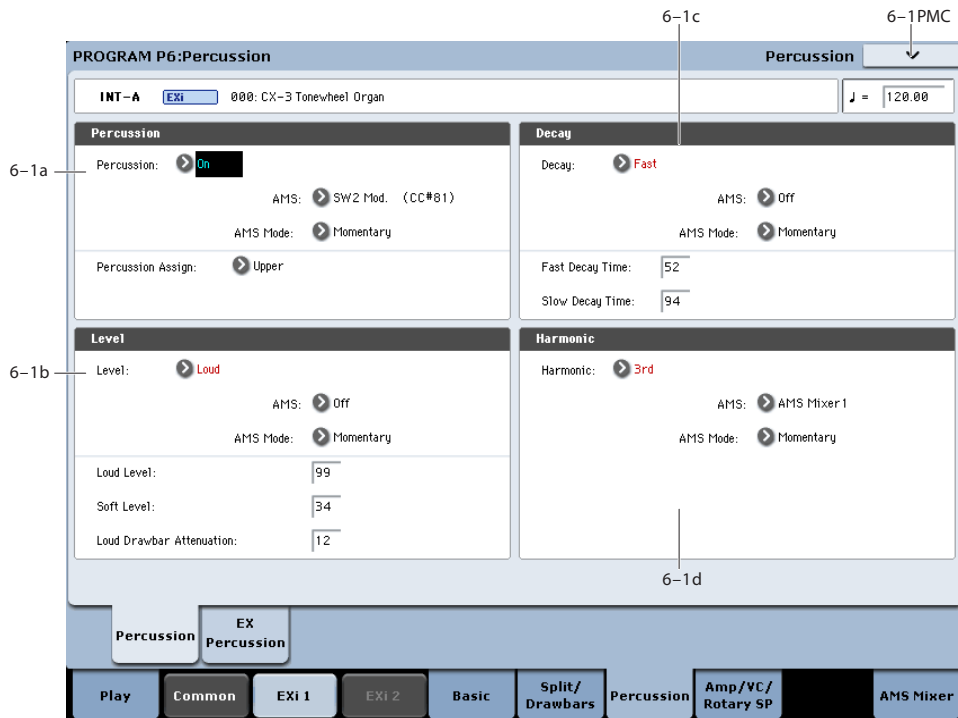

#### 6-1a: Percussion

**Percussion** [Off, On]

This toggles the Percussion section on and off.

Note that enabling Percussion for a set of drawbars (Upper or Lower) may affect the set's 1' drawbar; for more information, see "Interaction between Percussion, 1' drawbar, and EX mode" on page 232.

**AMS** [List of AMS Sources]

This selects an AMS source to turn the Percussion on or off. For a list of AMS sources, see "Alternate Modulation Source (AMS) List" on page 1091.

**AMS Mode** [Toggle, Momentary]

This determines the behavior of the Percussion AMS. For details, see "AMS Mode" on page 230.

**Percussion Assign** [Lower, Upper]

This assigns the percussion to either the lower or upper drawbars. The default is **Upper**. Setting it to **Lower**, instead, allows you to play a bass line with percussion.

If **Split** is **Off**, Percussion is automatically assigned to the Upper drawbars.

#### 6-1b: Level

**Level** [Soft, Loud]

This toggles the Percussion Level between Soft and Loud. The actual volume levels are determined by the **Loud Level** and **Soft Level** parameters, below.

Note that the Percussion Level parameter can also affect the volume of the drawbars, as controlled by the **Loud Drawbar Attenuation** parameter.

**AMS** [List of AMS Sources]

This selects an AMS source to switch the Percussion Level between Soft and Loud. For a list of AMS sources, see "Alternate Modulation Source (AMS) List" on page 1091.

**AMS Mode** [Toggle, Momentary]

This determines the behavior of the Level AMS. For details, see "AMS Mode" on page 230.

**Loud Level** [00...99]

This sets the volume of the percussion when Percussion Level is set to Loud.

**Soft Level** [00...99]

This sets the volume of the percussion when Percussion Level is set to Soft.



**Loud Drawbar Attenuation** [00...99]

On traditional tonewheel organs, setting the Level to Loud (or disabling the Soft button) reduces the overall drawbar volume.

To put it another way, setting the Level to Soft makes the drawbars louder.

This parameter controls the difference in drawbar volume between the Soft and Loud Percussion settings.

- **0: Write Program.** For more information, see “Write Program” on page 147.
- **1: Exclusive Solo.** For more information, see “Exclusive Solo” on page 147.

---

**6-1c: Decay**

**Decay** [Slow, Fast]

This toggles the Percussion Decay time between Slow and Fast. The actual decay times are determined by the **Fast Decay Time** and **Slow Decay Time** parameters, below.

**AMS** [List of AMS Sources]

This selects an AMS source to switch the Percussion Decay time between Slow and Fast. For a list of AMS sources, see “Alternate Modulation Source (AMS) List” on page 1091.

**AMS Mode** [Toggle, Momentary]

This determines the behavior of the Decay AMS. For details, see “AMS Mode” on page 230.

**Fast Decay Time** [00...99]

This sets the decay time when the Decay parameter is set to Fast.

**Slow Decay Time** [00...99]

This sets the decay time when the Decay parameter is set to Slow.

---

**6-1d: Harmonic**

**Harmonic** [2nd, 3rd]

This selects the pitch of the percussion, in harmonics relative to the 8' drawbar.

**2nd** produces the same pitch as the 4' drawbar - one octave higher than the 8'.

**3rd** produces the same pitch as the 2 2/3' drawbar - one octave and a fifth higher than the 8'.

**AMS** [List of AMS Sources]

This selects an AMS source to switch the Harmonic between 2nd and 3rd. For a list of AMS sources, see “Alternate Modulation Source (AMS) List” on page 1091.

**AMS Mode** [Toggle, Momentary]

This determines the behavior of the Harmonic AMS. For details, see “AMS Mode” on page 230.

---

**▼ 6-1: Page Menu Commands**

The number before each command shows its ENTER + number-key shortcut. For more information on these shortcuts, see “ENTER + 0-9: shortcuts for menu commands” on page 147.

## 6-2: EX Percussion

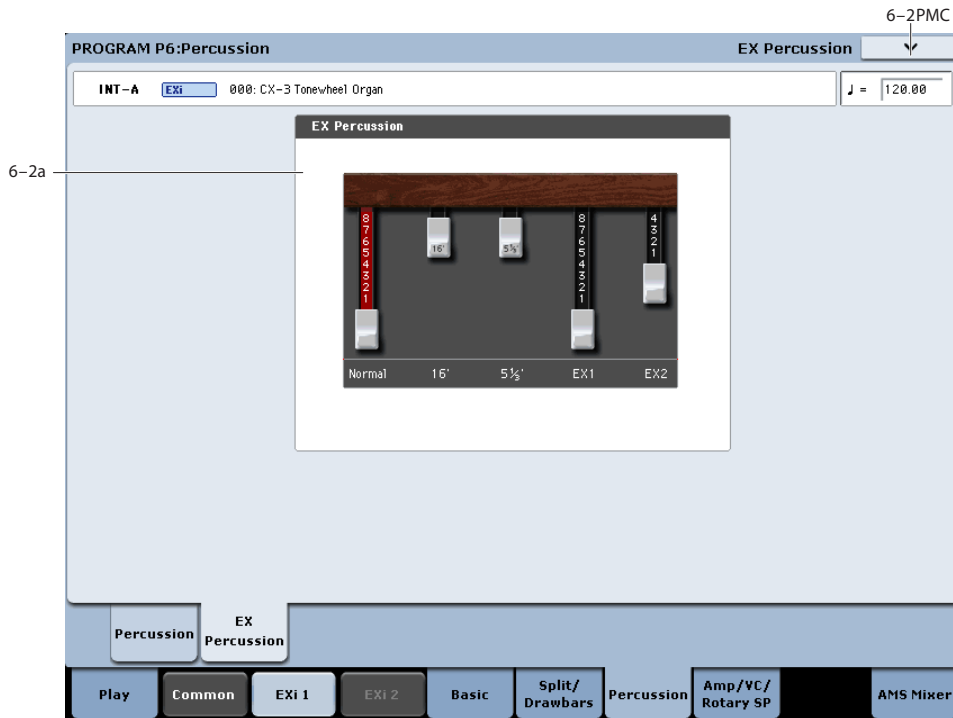

When the **Drawbar Mode** is set to **EX**, the Percussion can use a mix of up to five drawbar pitches, instead of just one.

These include 2-2/3' or 4' (depending on the setting of the Percussion Harmonic parameter), 16', 5-1/3', and the pitches of the first two EX drawbars. You can set the levels for each of the five drawbars independently.

This section is grayed out when **Drawbar Mode** is set to **Normal**.

### 6-2a: EX Percussion

#### Normal Percussion [0...8]

This sets the volume of the 2nd or 3rd harmonic (2-2/3' or 4' drawbars), depending on the setting of the **Percussion Harmonic** parameter.

#### 16' [0...8]

This sets the volume of the 16' drawbar within the Percussion pulse.

#### 5 1/3' [0...8]

This sets the volume of the 5-1/3' drawbar within the Percussion pulse.

#### EX Drawbar 1 [0...8]

This sets the volume of EX Drawbar 1 within the Percussion pulse.

#### EX Drawbar 2 [0...8]

This sets the volume of EX Drawbar 2 within the Percussion pulse.

### ▼ 6-2: Page Menu Commands

The number before each command shows its ENTER + number-key shortcut. For more information on these shortcuts, see "ENTER + 0-9: shortcuts for menu commands" on page 147.

- 0: **Write Program**. For more information, see "Write Program" on page 147.
- 1: **Exclusive Solo**. For more information, see "Exclusive Solo" on page 147.

## Program P7: Amp, V/C, Rotary Speaker

### 7-1: Amp & V/C



#### 7-1a: Amp

##### Amp Type [Type 1, Type 2, Pre Amp]

This selects one of two amp models, or a direct line-out from the organ's preamp.

**Type 1** is a standard powered amp for organ, producing a warm, fat tone.

**Type 2** yields a less colored tone, with more high frequencies than Type 1.

**PreAmp** is the sound of a direct line-out from the organ.

**Important:** Since Pre Amp models a direct line-out, it disables the Rotary Speaker entirely. To use the Rotary speaker, set **Amp Type** to Type 1 or Type 2 instead.

##### Amp Gain [00...99]

This adjusts the gain when **Amp Type** is set to **Type 1** or **Type 2**. It does not apply if the **Amp Type** is set to **PreAmp**.

**Expression** also adjusts the drive into the Amp section. With higher **Amp Gain** settings, you'll get more overdrive and distortion as you increase the **Expression** amount. For more information, see "4-2b: Expression," on page 230.

##### AMS [List of AMS Sources]

This selects an AMS source to modulate the **Amp Gain**. For a list of AMS sources, see "Alternate Modulation Source (AMS) List" on page 1091.

##### Intensity [-99...+99]

This controls the depth and direction of the AMS modulation of **Amp Gain**.

#### 7-1b: EQ

##### Treble [-10...+10]

This adjusts the high frequency range of the amp, as selected by **Amp Type**.

##### Mid [-10...+10]

This adjusts the mid-frequency range of the amp, as selected by **Amp Type**.

##### Bass [-10...+10]

This adjusts the low frequency range of the amp, as selected by **Amp Type**.

#### 7-1c: Vibrato/Chorus

Vibrato/Chorus is a traditional organ effect, similar to but not the same as other chorus effects. It adds varying degrees of LFO-driven flutter and richness to the timbre, and combines nicely with the rotary speaker.

In addition to the six traditional presets, the CX-3 allows you to create your own custom settings, which can then be modulated via AMS.

There is a single Vibrato/Chorus effect, and each set of drawbars can either be routed through the effect or go straight on to the rotary speaker and outputs.

**Upper Drawbars V/C** [Off, On]

This routes the upper drawbars through the Vibrato/Chorus.

**AMS** [List of AMS Sources]

This selects an AMS source to turn Vibrato/Chorus on or off for the Upper Drawbars.

**AMS Mode** [Toggle, Momentary]

This determines the behavior of the Vibrato/Chorus AMS for the Upper drawbars. For details, see “AMS Mode” on page 230.

**Lower Drawbars V/C** [Off, On]

This routes the lower drawbars through the Vibrato/Chorus.

**AMS** [List of AMS Sources]

This selects an AMS source to turn Vibrato/Chorus on or off for the Upper Drawbars. For a list of AMS sources, see “Alternate Modulation Source (AMS) List” on page 1091.

**AMS Mode** [Toggle, Momentary]

This determines the behavior of the Vibrato/Chorus AMS for the Upper drawbars. For details, see “AMS Mode” on page 230.

**Input Trim** [000...100]

This controls the input level to the Vibrato/Chorus.

It applies only to the set(s) of drawbars routed through the Vibrato/Chorus, via the V/C On/Off buttons above. You can use this to compensate for volume level differences between the output of the Vibrato/Chorus and the dry signal, so that the volume stays constant when you switch the V/C on or off.

Note that the output volume of the V/C will vary, depending on the selected Preset or the settings of the Custom parameters.

**Mode** [Preset/Custom]

When **Mode** is set to **Preset**, the Vibrato/Chorus will use the settings under Preset, below. These are the classic V1-3 and C1-3 settings.

When **Mode** is set to **Custom**, the Vibrato/Chorus uses the settings under Custom, below. These allow you to create your own versions of the effect.

---

**7-1d: Preset**

These parameters are available only if the **Mode**, above, is set to **Preset**.

**Type** [V1, C1, V2, C2, V3, C3]

This selects one of the six classic Vibrato/Chorus presets. “V” stands for Vibrato, and “C” stands for Chorus.

**AMS** [List of AMS Sources]

This selects an AMS source to modulate the **Type**. For a list of AMS sources, see “Alternate Modulation Source (AMS) List” on page 1091.

**Intensity** [-05...+05]

This controls the depth and direction of the AMS modulation for the **Type**.

---

**7-1e: Custom**

These parameters are available only if the **Mode**, above, is set to **Custom**.

**Mix** [0...100]

This adjusts the balance between the Vibrato and Chorus effects. **0** is all Vibrato; **100** is all Chorus.

**AMS** [List of AMS Sources]

This selects an AMS source to modulate the **Mix**. For a list of AMS sources, see “Alternate Modulation Source (AMS) List” on page 1091.

**Intensity** [-100...+100]

This controls the depth and direction of the AMS modulation for **Mix**.

**Depth** [0...100]

This sets the depth of Vibrato/Chorus modulation. Higher values mean greater pitch and volume modulation.

**AMS** [List of AMS Sources]

This selects an AMS source to modulate the **Depth**. For a list of AMS sources, see “Alternate Modulation Source (AMS) List” on page 1091.

**Intensity** [-100...+100]

This controls the depth and direction of the AMS modulation for **Depth**.

**Speed** [0.2Hz...20Hz]

This controls the speed of the Vibrato/Chorus LFO.

0 is 0.02Hz; 230 is 20 Hz; and 180 is 7Hz. Try around 179 for the magic C3 frequency.

**AMS** [List of AMS Sources]

This selects an AMS source to modulate the **Speed**. For a list of AMS sources, see “Alternate Modulation Source (AMS) List” on page 1091.

**Intensity** [-20Hz...0Hz...+20Hz]

This controls the depth and direction of the AMS modulation for **Speed**.

---

**7-1f: Main Output**

**Output Level** [000...127]

This controls the overall output level, after the Amp section and the Expression controls. In other words, this affects only the volume of the sound, and not the tonal character.

**AMS** [List of AMS Sources]

This selects an AMS source to modulate the **Output Level**. For a list of AMS sources, see “Alternate Modulation Source (AMS) List” on page 1091.

**Intensity** [-127...+127]

This controls the depth and direction of the AMS modulation for **Output Level**.

**Pan** [Random, L001...C064...R127]

This controls the stereo pan of the organ. A setting of **L001** places the sound at the far left, **C064** in the center, and **R127** to the far right.

When this is set to **Random**, the Pan position will change at each note-on. Note that all notes of the CX-3 share the same Pan value, and will move together to the new position.

You can also set the Pan directly from the Control Surface knobs. To do so:

1. Press the Control Surface **Timbre/Track** button.
2. Set the **MIXER KNOBS** switch to **INDIVIDUAL PAN**.
3. Move **Knob 1** to set the pan for **EXi 1**, and **Knob 2** to set the pan for **EXi 2**.

**MIDI** You can also control pan via MIDI Pan (CC#10). A CC#10 value of 0 or 1 places the sound at the far left, 64 places the sound at the location specified by the **Pan** parameter, and 127 places the sound at the far right.

**Note:** you can select Random pan only from the on-screen UI, and not from MIDI or the Control surface.

**AMS** [List of AMS Sources]

This selects an AMS source to modulate Pan. Note that all notes of the organ share the same Pan value. For a list of AMS sources, see “Alternate Modulation Source (AMS) List” on page 1091.

**Intensity** [-99...+99]

This controls the depth and direction of the AMS modulation for Pan.

▼ **7-1: Page Menu Commands**

The number before each command shows its ENTER + number-key shortcut. For more information on these shortcuts, see “ENTER + 0-9: shortcuts for menu commands” on page 147.

- **0: Write Program.** For more information, see “Write Program” on page 147.
- **1: Exclusive Solo.** For more information, see “Exclusive Solo” on page 147.

**7-2: Rotary Speaker**

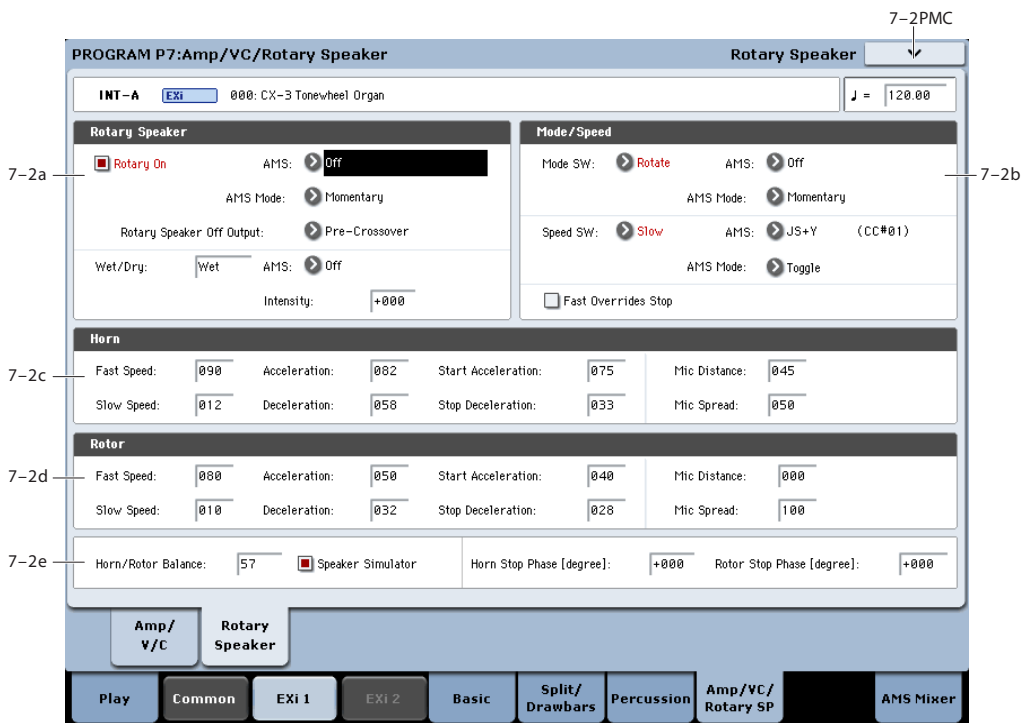

**7-2a: Rotary Speaker**

**Important:** To use the Rotary Speaker, the **Amp Type** must be set to Type 1 or Type 2. If it’s set to Pre Amp, the Rotary Speaker is disabled. For more information, see “Amp Type” on page 238.

**Rotary On** [Off, On]

This enables and disables the Rotary Speaker. It’s different from simply stopping the rotation (which you can do with the **Mode** parameter, below); instead, this is like unplugging the organ from the rotary speaker entirely.

When the Rotary Speaker is turned off, the tone is determined by the **Rotary Speaker Off Output** parameter, below.

**AMS** [List of AMS Sources]

This selects an AMS source to turn the Rotary Speaker on or off.

**AMS Mode** [Momentary, Toggle]

This determines the behavior of the Rotary Speaker on/off AMS. For details, see "AMS Mode" on page 230.

**Rotary Speaker Off Output** [Pre-Crossover, Post-Crossover]

This determines the sound when the Rotary Speaker is turned Off, above. It also determines the "dry" signal in the Wet/Dry mix; for details, see "Wet/Dry" on page 241.

**Post-Crossover** is the default, and matches the CX-3. With this setting, the speaker simulator and speaker crossover will still be active, even when the Rotary Speaker is disabled. Use this if you like the CX-3 sound, and are *not* sending the organ through a separate Rotary Speaker in the Insert Effects.

**Pre-Crossover** yields a tone without the effects of the speaker simulator and crossovers. Use this setting if you'll be sending the organ through a separate Rotary Speaker in the Insert Effects.

**Wet/Dry** [Dry,1:99...99:1,Wet]

This adjusts the balance between the dry signal coming into the Rotary Speaker and the output of the effect.

The "dry" signal is either the pre-crossover or post-crossover input, as selected by the **Rotary Speaker Off Output** parameter; for more information, see "Rotary Speaker Off Output" on page 241.

**AMS** [List of AMS Sources]

This selects an AMS source to modulate the Wet/Dry mix. For a list of AMS sources, see "Alternate Modulation Source (AMS) List" on page 1091.

**Intensity** [-100...+100]

This controls the depth and direction of the Wet/Dry AMS modulation.

**7-2b: Mode/Speed**

**Mode**

**Mode Switch** [Rotate, Stop]

This lets you stop the motion of the Rotary Speaker. Even when stopped, the speaker will still affect the timbre.

The horn and rotor can each take different amounts of time to start and stop their rotation. For more information, see "7-2c: Horn" on page 241 and "7-2d: Rotor" on page 242.

**AMS** [List of AMS Sources]

This selects an AMS source to start and stop the Rotary Speaker.

**AMS Mode** [Momentary, Toggle]

This determines the behavior of the Mode switch AMS. For details, see "AMS Mode" on page 230.

**Speed**

**Speed Switch** [Fast/Slow]

The Rotary Speaker has two basic speeds, and this allows you to switch between the two. You can set the speeds of the horn and rotor sections separately for both the Fast and Slow settings, as well as the time that it takes them to speed up and slow down. For more information, see "7-2c: Horn" on page 241 and "7-2d: Rotor" on page 242.

**AMS** [List of AMS Sources]

This selects an AMS source to switch between the Slow and Fast speeds.

**AMS Mode** [Toggle, Momentary]

This determines the behavior of the Speed switch AMS. For details, see "AMS Mode" on page 230.

**Fast Overrides Stop** [Off, On]

When this is enabled, switching the **Speed** to **Fast** via AMS will always push the Rotary Speaker into Fast mode - even if it had previously been stopped. Switching the **Speed** back to **Slow** will stop it again.

When Fast Overrides Stop is disabled, if the speaker is stopped, it will stay stopped regardless of Speed AMS.

**7-2c: Horn**

The Horn carries the high frequencies of the Rotary Speaker. You can independently control the Slow and Fast speeds of the horn, as well as the time it takes to speed up or slow down. You also have separate control over the amount of time that the horn takes to stop rotating entirely, and the time that it takes to resume rotation after being stopped.

**Fast Speed** [000...100]

This specifies the speed of the Horn when the **Speed Switch** is set to **Fast**.

**Slow Speed** [000...100]

This specifies the speed of the Horn when the **Speed Switch** is set to **Slow**.

**Acceleration** [000...100]

This sets how long it takes the Horn to change from the **Slow** speed to the **Fast** speed.

**Deceleration** [000...100]

This sets how long it takes the Horn to change from the **Fast** speed to the **Slow** speed.

**Start Acceleration** [000...100]

This sets how long it takes the Horn to come up to speed after the **Mode Switch** has changed from **Stop** to **Rotate**.

**Stop Deceleration** [000...100]

This sets how long it takes the horn to come to rest after the **Mode Switch** has changed from **Rotate** to **Stop**.

**Mic**

The Rotary Speaker model includes two pairs of stereo mics - one pair for the Horn, and the other for the Rotor.

**Horn Mic Distance** [000...100]

This adjusts the distance between the Horn and its microphones. Lower values bring the mics closer to the speaker.

**Horn Mic Spread** [000...100]

This adjusts the distance between the two Horn microphones, to widen the stereo field. Higher values increase the stereo effect.

---

**7-2d: Rotor**

The rotor carries the low frequencies of the Rotary Speaker. Its parameters are identical to those of the Horn, above.

**Fast Speed** [000...100]

This specifies the speed of the Rotor when the **Speed Switch** is set to **Fast**.

**Slow Speed** [000...100]

This specifies the speed of the Rotor when the **Speed Switch** is set to **Slow**.

**Acceleration** [000...100]

This sets how long it takes the Rotor to change from the **Slow** speed to the **Fast** speed.

**Deceleration** [000...100]

This sets how long it takes the Rotor to change from the **Fast** speed to the **Slow** speed.

**Start Acceleration** [000...100]

This sets how long it takes the Rotor to come up to speed after the **Mode Switch** has changed from **Stop** to **Rotate**.

**Stop Deceleration** [000...100]

Specifies the time it will take for the Rotor to actually come to rest after rotation is switched off.

This sets how long it takes the Rotor to come rest after the **Mode Switch** has changed from **Rotate** to **Stop**.

**Mic**

The Rotary Speaker model includes two pairs of stereo mics - one pair for the Rotor, and the other for the Horn.

**Rotor Mic Distance** [000...100]

This adjusts the distance between the Rotor and its microphones. Lower values bring the mics closer to the speaker.

**Rotor Mic Spread** [000...100]

This adjusts the distance between the two Rotor microphones, to widen the stereo field. Higher values increase the stereo effect.

---

**7-2e: Horn/Rotor****Horn/Rotor Balance** [Rotor, 1...99, Horn]

This sets the output balance between the high frequencies of the Horn and the low frequencies of the Rotor.

**Speaker Simulator** [Off, On]

This enables and disables modeling of the speaker tone. Note that if the **Rotary Speaker Off Output** is set to **Pre-Crossover**, the speaker simulation will also be left out of the dry signal.

**Horn Stop Phase** [Free, -180...+180]

When the **Mode Switch** is set to **Stop**, the Horn gradually comes to rest pointing one way or another. This allows you to control where it will stop.

**Free** lets it come to rest naturally, at a more or less random spot. The other settings, **-180** to **+180**, let you force it to land in a specific position.

The speaker position has a dramatic effect on the tone, so specifying a fixed position allows you to achieve consistent timbral results.

**Rotor Stop Phase** [Free, -180...+180]

This determines where the Rotor will land when the **Mode Switch** is set to **Stop**. For more details, see "Horn Stop Phase," above.

---

**▼ 7-2: Page Menu Commands**

The number before each command shows its **ENTER** + number-key shortcut. For more information on these shortcuts, see "ENTER + 0-9: shortcuts for menu commands" on page 147.

- **0: Write Program**. For more information, see "Write Program" on page 147.
- **1: Exclusive Solo**. For more information, see "Exclusive Solo" on page 147.



## Program P9: AMS Mixer

The AMS Mixers combine two AMS sources into one, or process an AMS source to make it into something new.

For instance, they can add two AMS sources together, or use one AMS source to scale the amount of another. You can also use them to modify the response of realtime controllers.

The AMS Mixer outputs appear in the list of AMS sources, just like other controllers.

This also means that the original, unmodified inputs to the AMS Mixers are still available as well. For instance, if you use Aftertouch as an input to a AMS Mixer, you can use the processed version of the Aftertouch to control one AMS destination, and the original version to control another.

Finally, you can cascade the two AMS Mixers together, by using AMS Mixer 1 as an input to AMS Mixer 2.

### 9-1: AMS Mixer

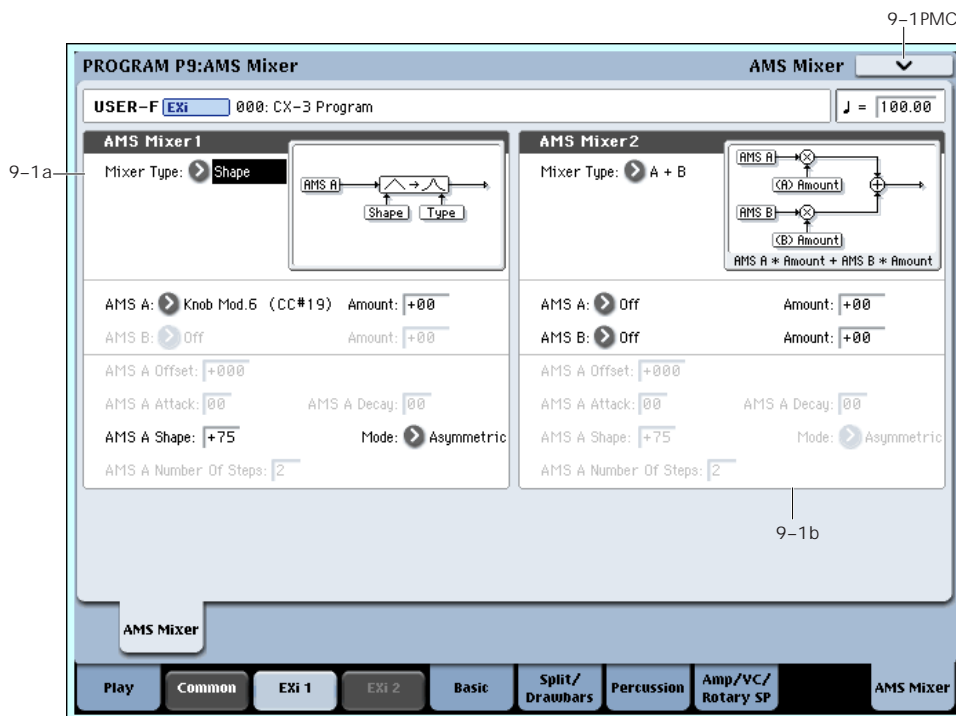

#### 9-1a: AMS Mixer 1 AMSource

**Mixer Type** [A+B, Amt AxB, Offset, Smoothing, Shape, Quantize]

This controls the type of processing performed by AMS Mixer 1.

**A+B** adds two AMS sources together. For more information, see “A+B” on page 99.

**Amt AxB** scales the amount of one AMS source with the other. See “Amt A x B” on page 99 for more details.

**Offset** adds or subtracts a constant value to or from an AMS source. For more information, see “Offset” on page 100.

**Smoothing** creates more gentle transitions between values, smoothing out abrupt changes such as a quick move on a joystick or a sharp edge on an LFO. For details, see “Smoothing” on page 101.

**Shape** adds curvature to the AMS input. For an in-depth description, see “Shape” on page 101.

**Quantize** turns smooth transitions into discrete steps. See “Quantize” on page 102 for more information.

**Gate** chooses between two AMS inputs (or fixed values) based on a third AMS source. See “Gate” on page 103 for more information.

#### 9-1b: AMS Mixer 2 AMSource

This is the second AMS Mixer. Its parameters are exactly the same as those of AMS Mixer 1, above.

#### ▼ 9-1: Page Menu Commands

The number before each command shows its ENTER + number-key shortcut. For more information on these shortcuts, see “ENTER + 0-9: shortcuts for menu commands” on page 147.

- 0: **Write Program**. For more information, see “Write Program” on page 147.
- 1: **Exclusive Solo**. For more information, see “Exclusive Solo” on page 147.

## CX-3: Tone Adjust

CX-3 Tone Adjust Default Settings

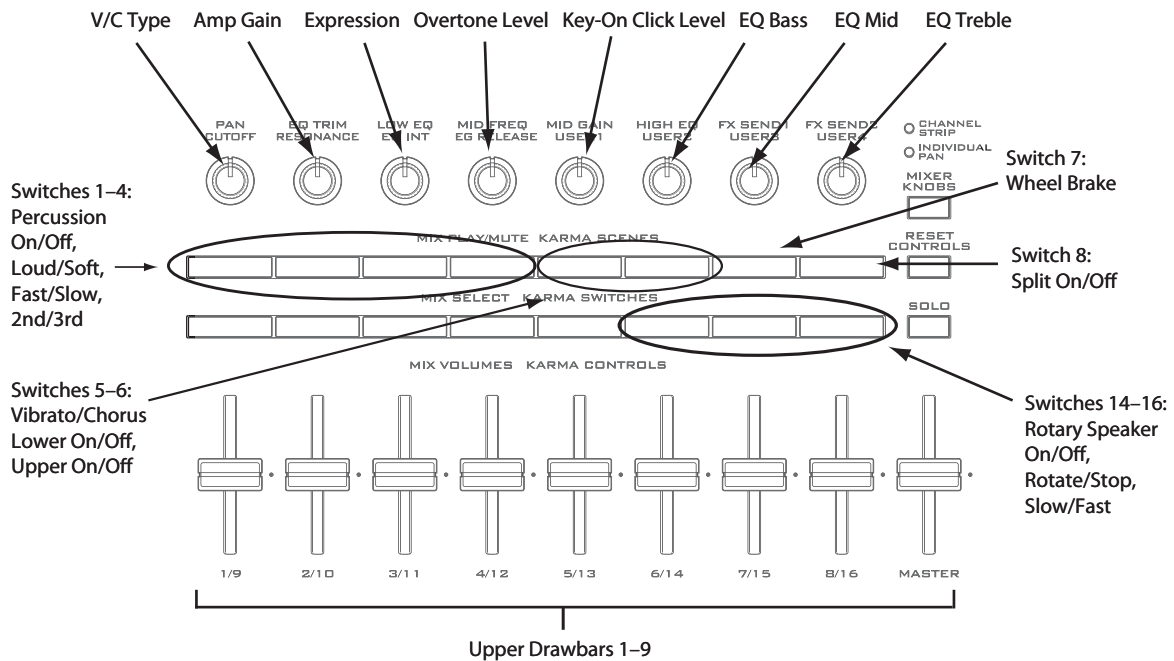

Tone Adjust provides an elegant physical interface to the CX-3's parameters. Most of the factory sounds use the default layout, as shown above.

You can also customize the layout for individual sounds, if desired. For instance, most of the factory sounds use the sliders for the upper drawbars; if you like, you can re-assign them to the lower drawbars instead.

For more information about Tone Adjust, please see "0-9f: Tone Adjust," on page 30.

### CX-3 Tone Adjust parameters

The CX-3 is substantially different from other EXi instruments, so it does not support the Common Tone Adjust parameters. Instead, it adds a number of its own, unique parameters, as described below.

All of these parameter are absolute, which means that they over-write the stored parameter values.

Note that these controls are separate for each EXi, as opposed to being shared by both EXi in the Program.

#### Drawbars

- Upper Drawbars 1-9
- Lower Drawbars 1-9
- Upper EX Drawbars 1-4
- Lower EX Drawbars 1-4
- Noise level
- Leakage level
- Wheel Brake
- Overtone Level
- Key-On Click Level

#### Percussion

- Percussion On/Off
- Level Soft/Loud
- Decay Slow/Fast
- Harmonic 2nd/3rd
- EX Percussion levels 1-5

#### Vibrato/Chorus

- Vibrato/Chorus Type
- Upper Drawbars V/C On/Off
- Lower Drawbars V/C On/Off

#### Expression

- Expression Level

#### Amp

- Amp Gain
- EQ Bass
- EQ Mid
- EQ Treble

#### Split

- Split On/Off

#### Rotary Speaker

- On/Off
- Rotate/Stop
- Slow/Fast

## Changes from the original CX-3

With the KRONOS CX-3, Korg has taken the original, ground-breaking CX-3 model and made it even better. If you'd like to convert sounds from the original CX-3, the following notes describe these changes in detail.

### Noise Level range improved

The Noise Level parameter now offers more fine control over the most useful range of values. When converting sounds, multiply the original CX-3 Noise Level by 10.

### EX Mode enhanced

On the original CX-3, there were four global settings for the EX Mode drawbar frequencies. The KRONOS CX-3 offers four global presets, which match the factory defaults of the original CX-3, and then also allows you to set different frequencies for each Program if desired.

The range of the EX drawbar pitches has also been extended to go all the way down to 16', in semitone steps.

Finally, the KRONOS CX-3 supports keyboard splits with full EX drawbars on both upper and lower sides of the split.

### Split Transpose increased

You can now transpose both sides of the split up or down by up to two octaves, for more flexible zoning on larger keyboards (such as 73- and 88-key instruments).

### Expression parameters per-Program

The expression-related parameters can be set separately for each Program.

### Percussion for either lower or upper drawbars

The percussion can be assigned to either the lower or upper drawbars, instead of just the upper drawbars. This allows you to play a bass line with percussion, as in ELP's "Tarkus."

### Percussion parameters changed to absolute values

Instead of relative offsets, you can directly set the values for Percussion Slow and Fast Decay, and Percussion Loud and Soft.

### Vibrato Chorus custom mode added

In addition to the six traditional presets, you can create your own custom settings, which can then be modulated via AMS.

### Rotary Speaker Mic Modeling

For consistency with the rest of the KRONOS, the value ranges of the mic modeling parameters have been changed slightly. On the original CX-3, they were 0-99; in the KRONOS, they are 0-100.

Additionally, the parameter ranges of the Horn and Rotor Mic Distance parameters are reversed. To convert these parameters from the original CX-3, use the following formula:

Mic Distance = 100-(original CX-3 mic distance)

### Rotary Speaker Acceleration and Deceleration

The Rotary Speaker Acceleration/Deceleration parameters were named "Transit" on the original CX-3. To be consistent with the rest of the system, the KRONOS values range from 0 (slowest) to 100 (fastest), while the original CX-3 went from 99 (slowest) to 0 (fastest).

Additionally, for the Horn only, the maximum acceleration, deceleration, start, and stop rates have been increased to about twice that of the original CX-3. The minimum rates are still the same.

To convert settings from the original CX-3 Horn "Transit" parameters, use the following formula, rounding as necessary:

KRONOS value = (100 - (original CX-3 value))/100 x 52

In other words, the KRONOS value range of 52...0 is equivalent to the original CX-3 range of 0...99, and KRONOS values 53 and higher are all faster than the original CX-3.

To convert settings from the original CX-3 Rotor "Transit" parameters, the formula is:

KRONOS value = 100 - (original CX-3 value)

### Rotary Speaker Stop Phase added

You can now set the phase at which the Horn and Rotor will settle when the Rotary Speaker stops.

## CX-3: Page Menu Commands

---

### Copy Drawbars

This copies drawbar or EX drawbar settings within the CX-3 oscillator.

1. Select “Copy Drawbars” to access the dialog box.

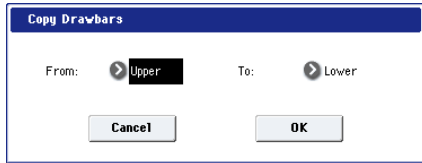

2. Use the “From” field to specify the copy-source drawbars.
3. Use the “To” field to specify the copy-destination drawbars.
4. Press the OK button to execute the Copy Drawbars operation. If you decide to cancel, press the Cancel button.

---

### Swap Drawbars

This exchanges drawbar or EX drawbar settings within the CX-3 oscillator.

1. Select “Swap Drawbars” to access the dialog box.

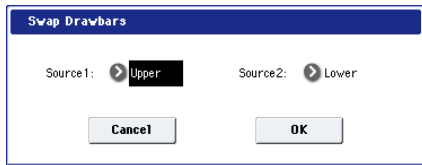

2. Use the “Source1” and “Source2” fields to specify the two sets of drawbars you want to exchange.
3. Press the OK button to execute the Swap Drawbars operation. If you decide to cancel, press the Cancel button.

# EXi: STR-1 Plucked String

## STR-1 Overview

The STR-1 Plucked String offers a comprehensive and sophisticated set of physical modeling synthesis tools, capable of creating both traditional sounds (acoustic and electric guitars and basses, clavinet and harpsichords, harps, bells, electric pianos, ethnic instruments, etc.) and unique, experimental timbres.

Some of the feature highlights include:

- Physically modeled string, including damping, decay, dispersion, nonlinearity, and harmonics
- String excitation via a selection of “pluck” types, a noise generator with saturation and dedicated filter, and any mono samples from ROM, EXs, Sampling Mode, or User Sample Banks (using Korg’s ultra-low-aliasing PCM oscillator, as first introduced in the HD-1)
- Dual multi-mode resonant filters (including Korg’s Multi Filter, as first introduced in the AL-1), plus an additional multi-mode resonant filter dedicated to the string excitation
- Live audio input, including modeled feedback
- Up to 40-voice polyphony
- Four per-voice LFOs, five re-triggerable EGs, two key tracking generators, a string tracking generator, and four AMS mixers
- Access to all standard EXi Program features, including the Common LFO, Common Step Sequencer, Key Track 1 & 2, KARMA, EQ, and effects—as well as layering with any other EXi (including using two STR-1s together!)

STR-1 Overview

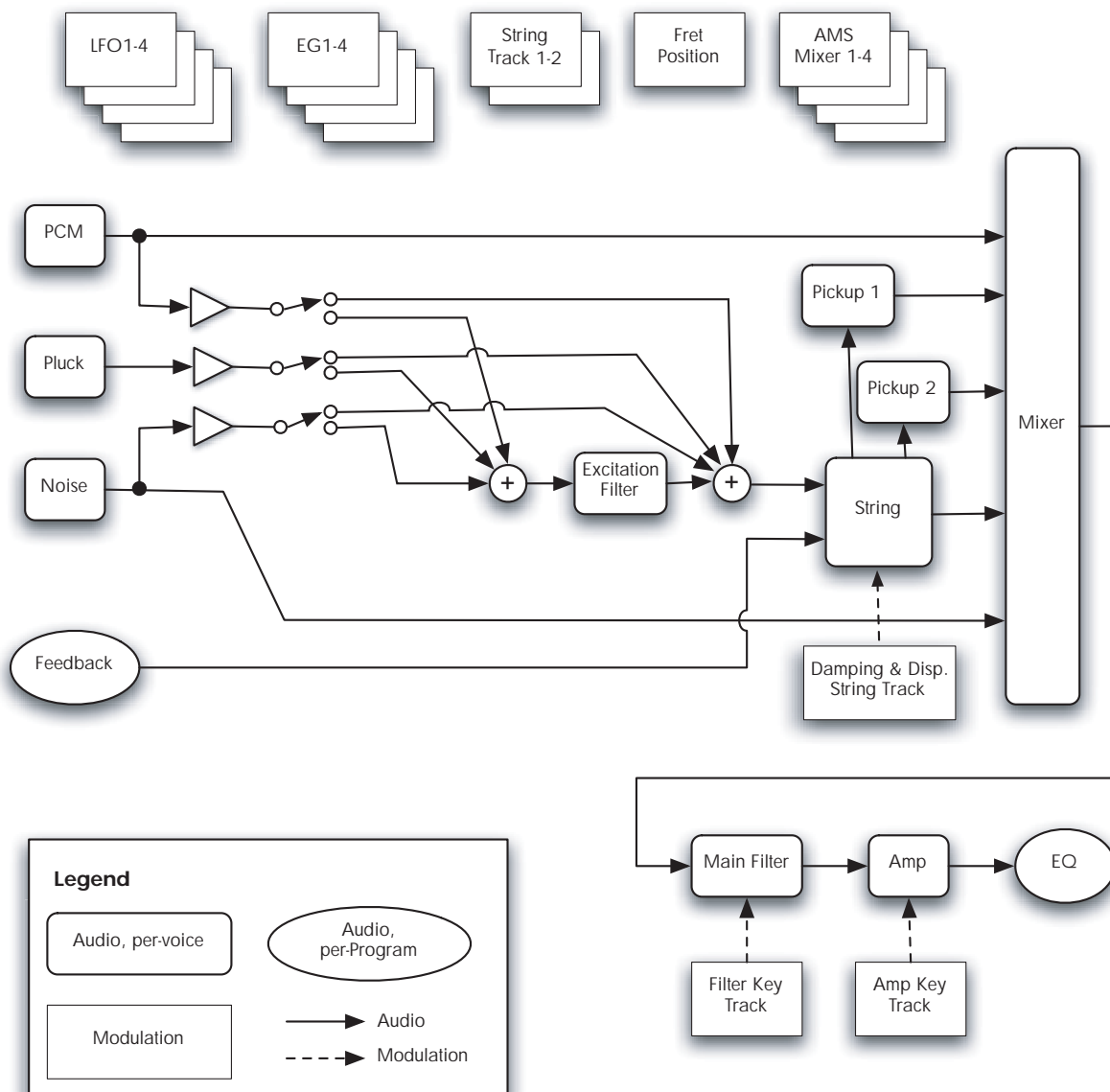

---

### **STR-1 uses EXi fixed resources**

The STR-1 uses EXi fixed resources for its modeled feedback. This uses up a small amount of processing power, even if you're not playing any notes.

Because of this, you can use only sixteen STR-1s simultaneously in a Combination or Song. If other EXis with fixed resources are in use, the maximum number of STR-1s will be reduced accordingly. Each EXi in each Program counts towards the maximum; for instance, a Program with two STR-1s counts as two, not as one.

For more information, see "CX-3 & other EXi: Limitations on EXi fixed resources" on page 420.

---

### **Unsupported EXi Common parameters**

The STR-1 supports all of the EXi Common parameters, except for two of the voice allocation options: **Poly Legato** and **Mono Mode** (Normal/Use Legato Offset).

All of the other voice allocation options are fully supported, including Mono, Mono Legato, Unison, etc.

## EXi Program P0: Play

### 0-1: Main

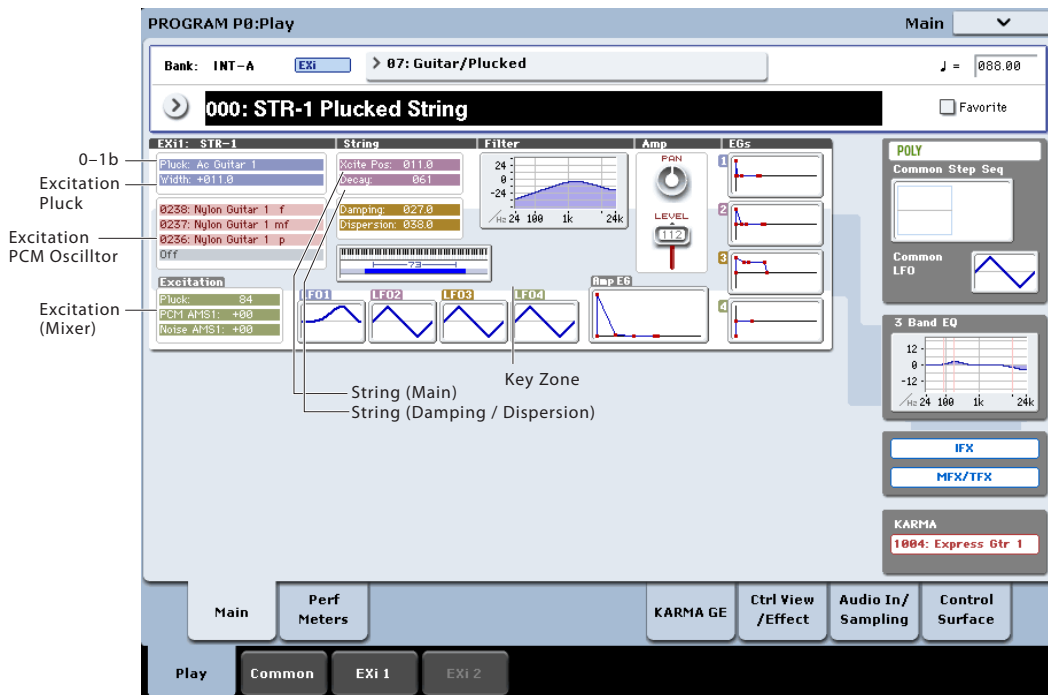

This is the main page of Program mode. For a full description of this page and all of its functions, please see “EXi Program P0: Play” on page 165. This section describes only the overview display, which differs for each individual EXi.

#### 0-1b: Overview and Page Jump

This part of the page shows an overview of the most important settings for the Program’s two EXi instruments. The specific parameters will vary, depending on which EXi are being used. The specific parameters for the STR-1 are described below.

The graphics give you a quick way to check all of these settings at a glance. They also let you jump instantly to any of the displayed parameters. Just touch one of the sections, and you’ll jump to the page containing its parameters. For instance, if you touch the Filter EG graphic, you’ll go to the Filter EG page.

*Tip:* Pressing EXIT several times will always bring you back to this page.

#### Excitation

##### Pluck

This area shows the selected **Pluck Type** and **Width**.

Touch this area to jump to the 4-1 Pluck and Noise page.

##### PCM Oscillator

This area shows the four Multisamples selected for the PCM Oscillator. Colors are used to distinguish between the various possibilities, as detailed below.

- Red: ROM, EXs, and User Sample Bank Multisamples
- Green: Sampling Mode Multisamples
- Grey: Off

Touch this area to jump to the 4-2 PCM Oscillator page.

##### Excitation (Mixer)

This shows the excitation **Level** for the Pluck, and the **AMS1 Intensities** for the Noise Generator and PCM Oscillator (since these levels will often be controlled completely via AMS).

Touch this area to jump to the 4-4 Excitation Mixer page.

##### String

##### String Main

This shows the **Excitation Position** and **Decay** settings for the string.

Touch this area to jump to the 4-5 String Main page.

##### Damping and Dispersion

This shows the **Damping** and **Dispersion** settings for the string.

Touch this area to jump to the 4-6 Damping and Dispersion page.

##### Output

##### Filter

This shows a graphic representation of the filter frequency response, including cutoff and resonance.



Press this area to jump to the 5-1 Filter Basic page.

### **Amp**

This shows the Amp section's **Pan** and **Amp Level** values.

Press this area to jump to the 6-1 Amp page.

### **EGs and LFOs**

#### **EG 1...4, Amp EG Graphics**

These show the shapes of the five EGs. Touch any of them to jump directly to the corresponding edit page.

#### **LFO 1, 2, 3, 4 Graphic**

These show the waveforms and shapes of the four LFOs. Touch any of them to jump directly to the corresponding edit page.

### **Key Zone**

#### **Key Zone**

This shows the key zones for EXi1 and EXi2, as set on the Common section's Program Basic page, in relation to the entire MIDI note range. The range of the 61-, 73-, or 88-note keyboard is also shown, as appropriate.

Press this area to jump to the Program Basic page.

### **Common**

The graphics along the right side of the screen show the most important Common parameters, which are shared by both EXi in the Program. This section will always show the same parameters, regardless of which EXi are being used.

#### **Common Voice Assign Mode**

This shows the voice assign mode of the Program—either POLY or MONO.

Press this area to jump to the Program Basic page.

#### **Common Step Sequencer**

This shows a graphic overview of the Common Step Sequencer.

Press this area to jump to the Common Step Sequencer page.

#### **Common LFO Graphic**

This shows the waveform of the Common LFO.

Press this area to jump to the Common LFO page.

#### **3 Band EQ Graphic**

This shows the mid-sweepable 3-band EQ.

Press this area to jump to the EQ page.

### **IFX, MFX/TFX**

Press the IFX area to jump to the IFX Routing page.

Press the MFX/TFX area to jump to the MFX Routing page.

### **KARMA GE Name**

This shows the name of the selected KARMA GE.

Press this area to jump to the GE Setup/Key Zones page.

## Program P4: String

### 4-1: Pluck and Noise

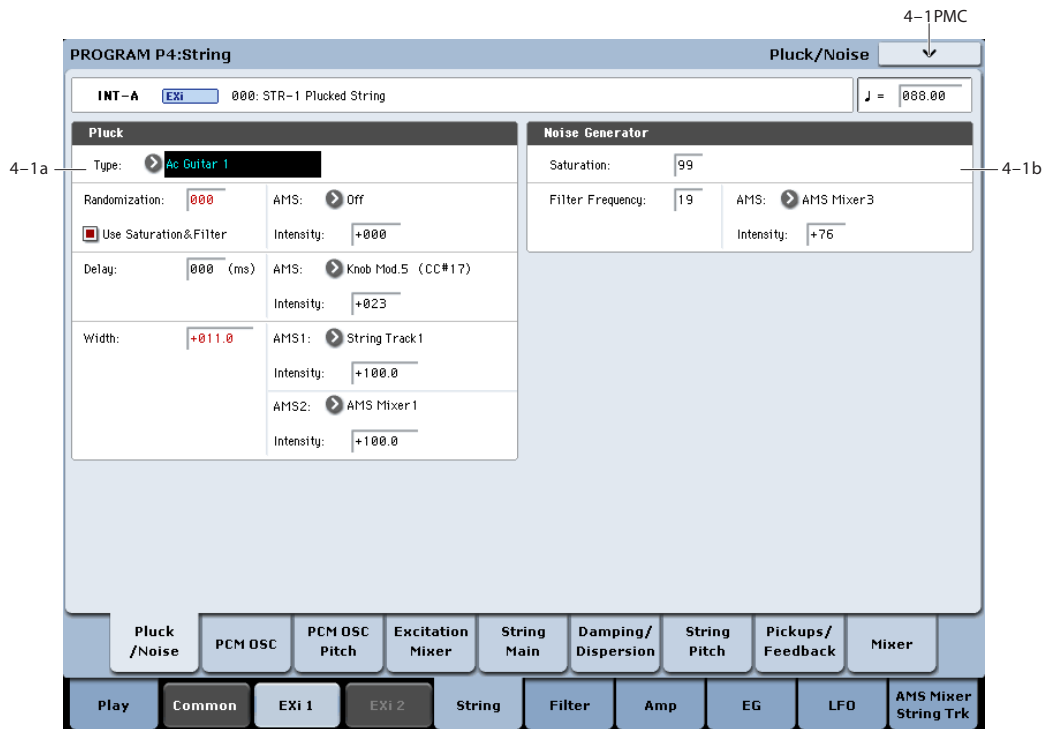

#### 4-1a: Pluck

##### Type [Ac Guitar 1...Harpichord]

This selection models different types of plucking actions, including picks and finger-plucking. The pluck type sets the basic tone of the plucked string.

You can also “pluck” the string using the Noise Generator, as well as PCM samples. You can even combine all three types of excitation together, to create specific tones.

**Ac Guitar 1.** This type is a little unusual, in that it includes the “pluck position” in the pluck sound itself. Because of this, it’s probably best to set the **Excitation Position Tone** to 0, so that the **Excitation Position** itself has no effect. (For more information, see “Tone” on page 262.)

**Ac Guitar 2.** This is similar to A. Guitar 1, but does not include the “pluck position” in the sound. As with most of the other types, it will generally work better with **Excitation Position Tone** set to -100.

**Dark E. Guitar, Bright E. Guitar, Resonant E. Guitar, Dark Jazz Guitar, Bright Jazz Guitar, Brighter Jazz Guitar.** With all of the E. Guitar and Jazz Guitar pluck types, set the **Excitation Position** between 5 and 35.

**Square Pluck.** With randomization turned up, this sounds like bright clav or harpsichord.

**Midrange Pluck.** This is similar to Square Pluck, but with more midrange harmonics.

**Smooth Pulse.** This has very few harmonics, for a mellow and full tone.

**Resonant Pulse.** This is similar to Smooth Pulse, but brighter and more resonant.

**Dark Clav, Midrange Clav, Bright Clav.** These offer variations on clavinet sounds.

**Harpichord.** This type includes small amount of noise before the main pluck.

##### Randomization [0...100]

This adds a small amount of variation to each strike of the pluck, by adding in a small amount of the Noise Generator’s output. The tone of the randomization is affected by the **Use Saturation & Filter** parameter, below.

##### Use Saturation & Filter [Off, On]

This controls whether or not **Randomization**, above, is affected by the Noise Generator’s **Saturation** and **Filter Frequency** parameters.

To use simple white noise for the **Randomization**, which will generally yield the brightest pluck timbre, turn this **Off** (un-checked).

##### AMS [List of AMS Sources]

This selects a modulation source to control the **Randomization**. For a list of AMS sources, see “Alternate Modulation Source (AMS) List” on page 1091.

##### Intensity [-100...+100]

This controls the depth and direction of the **Randomization** AMS modulation.

**Delay (milliseconds)** [0...250]

You can delay the Pluck by up to 250ms after the initial note-on. This lets you create double-strike effects and complex attacks. For instance, try using an envelope with a slow attack time to control the volume or filter cutoff of the PCM Oscillator or Noise Generator, and then combining this with a delayed Pluck.

**AMS** [List of AMS Sources]

This selects a modulation source to control the **Delay**. For a list of AMS sources, see “Alternate Modulation Source (AMS) List” on page 1091.

**Intensity** [-250...+250]

This controls the depth and direction of the **Delay** AMS modulation.

**Width** [-100.0...+100.0]

This models the time that the pick is in contact with the string, which is a combination of the size and thickness of the pick, and the speed at which the pick is moving.

The width adjusts the tone of the initial string excitation; low settings emphasize lower frequencies, and high settings emphasize high frequencies.

To put it another way, **-100.0** is very “wide,” and **+100.0** is very narrow.

Low or negative width settings may cause thumpiness at the high end of the keyboard, but this can be solved using a number of different techniques. For more information, see “Tips for avoiding “thumpy” excitation,” below.

**AMS 1** [List of AMS Sources]

This selects the first modulation source to control the **Width**. For a list of AMS sources, see “Alternate Modulation Source (AMS) List” on page 1091.

**Intensity** [-100.0...+100.0]

This controls the depth and direction of the **Width** AMS modulation.

**AMS 2** [List of AMS Sources]

This selects the second modulation source to control the **Width**. For a list of AMS sources, see “Alternate Modulation Source (AMS) List” on page 1091.

**Intensity** [-100.0...+100.0]

This controls the depth and direction of the second **Width** AMS modulation.

**Tips for avoiding “thumpy” excitation**

To avoid low-end “thumps” at the top end of the keyboard:

- Make sure the duration of the excitation input is about the same as one period of the waveform. To do this when using the Pluck as the excitation, you’ll probably need to use note number or Key Tracking to scale the **Pluck Width** so that it gets more narrow (higher values) as you play higher on the keyboard.
- Similarly, when using the PCM oscillator or noise generator as the excitation, use an EG to control the level at the Excitation mixer (or the cutoff of the Excitation Filter), and then scale the EG times so

that they become shorter as you play higher on the keyboard.

- Try setting the **Excitation Position Tone** to **-100**.
- In the main mixer, use the pickups instead of the direct string output.
- Set the **Excitation Filter Type** to **Highpass**, and track its cutoff frequency with Note Number.
- Set the main **Filter Type** to **Highpass**, and track its cutoff frequency with Note Number. If you are using Filter A as a lowpass filter, set the **Routing** to **Serial** and then make Filter B the highpass filter.

**4-1b: Noise Generator**

The noise generator includes **Saturation**, for creating unique and chaotic noise effects, and a dedicated 1-pole filter to control noise color.

For standard white noise, set the **Saturation** to **0**, and the **Filter Frequency** to **99**.

For colored noise (such as pink noise), set the **Saturation** to **0**, and reduce the **Filter Frequency** as desired.

To create “speckled noise” such as rocket sounds and thunder, set **Saturation** to **99**, and **Filter Frequency** to **10**.

To create key contact noise (such as you might find on vintage analog synths), create speckled noise as described above, and then use a fast EG to control its volume in the mixer.

**Saturation** [0...100]

This control clips the noise signal, for added crunch. Subtle variations in saturation are more noticeable with very low **Filter Frequency** settings (see below), allowing you to create organic, rumbling timbres.

**Filter Frequency** [0...100]

This is a simple, 1-pole lowpass filter for controlling the “color” of the noise.

**AMS** [List of AMS Sources]

This selects the first modulation source to control the noise generator’s **Filter Frequency**. For a list of AMS sources, see “Alternate Modulation Source (AMS) List” on page 1091.

**Intensity** [-100...+100]

This controls the depth and direction of the **Filter Frequency** AMS modulation.

**▼ 4-1: Page Menu Commands**

The number before each command shows its ENTER + number-key shortcut. For more information on these shortcuts, see “ENTER + 0-9: shortcuts for menu commands” on page 147.

- **0: Write Program**. For more information, see “Write Program” on page 147.
- **1: Exclusive Solo**. For more information, see “Exclusive Solo” on page 147.

## 4-2: PCM Oscillator

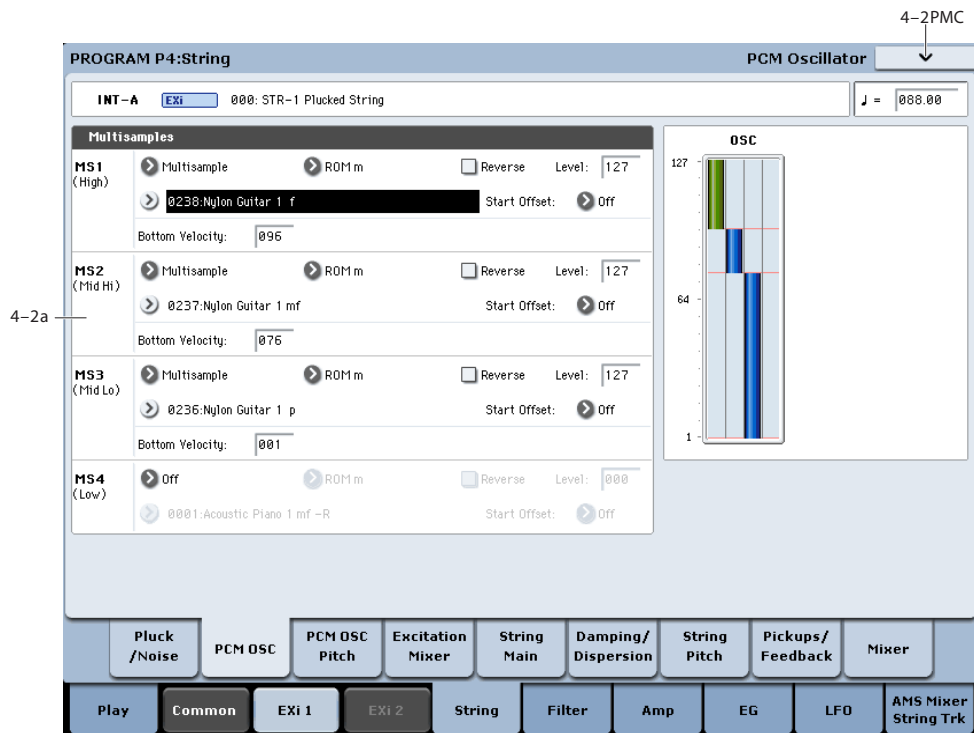

### Using PCM in the STR-1

#### Using PCM samples to “pluck” the string

In addition to the Pluck and the Noise Generator, you can also “pluck” the string with PCM samples. In general, this will work best if you use a fast envelope to control the level of the PCM in the Excitation Mixer, so that it becomes just a short attack transient.

For instance:

1. Follow the steps under “Creating an initialized STR-1 Program” on page 254.
2. Press the EXi 1 tab, to get to the STR-1 parameters.
3. Go to the Excitation Mixer page (P4-4).
4. Set both the Pluck and PCM Levels to 0.
5. Set the PCM Level AMS 1 source to EG 3, and the AMS1 Intensity to 50.
6. Go to the EG 3 page (P7-3).
7. Set the Start and Sustain Levels to 0, and the Attack and Break Levels to 99.
8. As a first pass, set the Attack Time to 0, the Decay Time to 10, and the Slope Time to 2.

With these settings, the **Attack Time** controls how fast the EG attacks, the **Decay Time** sets the duration, and the **Slope Time** controls the decay.

9. Use Key Track or Note Number to modulate the Decay time via AMS, so that it is shorter for higher notes, and longer for lower notes.

If you use looped PCM as the excitation, without EG control of the amplitude, it will tend to sound like bowing. In this case, using a bit of constant **Harmonic Pressure** can produce a good effect; among other things, this removes some energy from the string.

#### Using the string as a comb filter for PCM

You can use the string as a comb filter for the PCM Oscillator. To do so:

1. Follow the steps under “Creating an initialized STR-1 Program” on page 254.
2. Press the EXi 1 tab, to get to the STR-1 parameters.
3. On the PCM Oscillator page (P4-2), set MS1 to use Multisample 0433 POWER SAW.

You can use this technique with any Multisample, but a sawtooth waveform will make the effect particularly clear.

4. On the Excitation Mixer page (4-4), set the Pluck Level to 0, and the PCM Level to 25.
5. On the EG2 (Pitch) page (P7-2), set the Attack Time to 50, and the Decay Time to 70.
6. Set the Break and Sustain Levels to +25.
7. Set the Attack and Decay Curves to +5.
8. On the String Pitch page (P4-7), in the EG section, set the Intensity to +36.00.

EG2 (Pitch) is already selected, by default. In this setup, the string’s pitch controls the frequency of the comb filter.

9. Play a note in the lower part of the keyboard. Notice how the Program makes a sweeping sound, with some resemblance to oscillator sync. That’s the sound of the comb filter.
10. Experiment with the String’s Decay parameter. Decay controls the resonance of the comb filter.
11. Experiment with the Damping and Dispersion parameters.

These can change the character of the comb filter in interesting ways.

### Layering PCM with modeled string timbres

You can also simply layer PCM samples with string timbres. To do so, set the **Filter Routing** to **Parallel**, and then use the Mixer page to route the PCM Oscillator to Filter A, and the String to Filter B (or vice-versa). For more information, see “5-1a: Routing” on page 274, and “4-9: Mixer” on page 272.

### Creating an initialized STR-1 Program

For the examples above, it can be useful to start with the default STR-1 settings. To do so:

1. In Program mode, select INT–A 040 Felix’sDaKat.
2. Press the Common tab, and then the Basic/Vector tab, to go to the Basic/Vector page (P4–4).
3. Under EXi Instrument Type, select STR-1 Plucked String.

Now, you have an initialized STR-1 Program.

---

## 4–2a: Multisamples

This section selects the Multisamples to be used for the string excitation.

### Velocity splits

As mentioned above, each Oscillator has four velocity zones, named MS1 (High) through MS4 (Low). Each of these zones can play a different Multisample, and has separate settings for Level, Start Offset, and so on.

Note that, unlike the HD-1, crossfades and layers are not supported.

### MS1 (High)

These are the settings for the first and highest velocity zone.

If you want to create a simple setup with only a single Multisample, just set up MS1 as desired, and then set the **Bottom Velocity** to 1.

**Type** **[Off, Multisample]**

This selects whether MS1 will play a Multisample, or nothing at all. You can use this to disable any of the four Multisamples.

**Bank** **[List of Multisample Banks]**

There are four types of Multisample Banks: **ROM**, **Sampling Mode**, **EXs**, and **User Sample Banks**.

**ROM** Multisamples are the built-in “factory” sounds, and are always available.

**Smp (Sampling Mode)** Multisamples are the ones that you can see and edit in Sampling Mode. After the abbreviation “Smp,” several different things may appear, as described below.

**Smp: Old RAM** means that this is an older Program pointing to the legacy “RAM” bank. Instead of pointing to a specific User Sample Bank, it will use whatever Multisample data is loaded into Sampling Mode. Updating to the new format is easy; for more information, see “Converting older sounds” on page 155 of the Operation Guide.

**Smp: New Sampling Session** will appear when there’s data in Sampling Mode which hasn’t yet been saved to disk as a User Sample Bank. For instance, this might happen if you’ve loaded an old KSC file, loaded individual Samples or Multisamples, or recorded some new samples. Once the KSC is saved to disk, the name will update to show the file path (as described below).

**Smp: [file name]** will appear when a User Sample Bank has been loaded into Sampling Mode. The name is the file name itself along with those of all its enclosing folders.

**EXs** Multisample banks are PCM expansion sets created especially for the KRONOS. Each has its own unique number; for instance, the ROM Expansion is EXs1, and the Concert Grand Piano expansion is EXs2. Only the currently loaded EXs banks will appear on this menu.

**User Sample Banks** bring the benefits of EXs to your own sample libraries. You can load and play gigabytes of your custom or converted samples at once, using Virtual Memory. The name is shown as a path to the KSC file, including the file name and the names of all enclosing directories. Only the currently loaded User Sample Banks will appear in this menu.

If a sound refers to a User Sample Bank which is not on the internal drive(s), the name will appear as “Unknown Sample Bank [number]” when the bank select dialog is open, shortened to “??[number]” when the dialog is closed.

For more information, see “User Sample Banks” on page 154 of the Operation Guide.

 Note that unlike the HD-1, you can only select mono Multisamples.

**Multisample Select** **[List]**

This parameter lets you select a Multisample for the velocity zone. You can use any mono Multisample, or the left or right channel of a stereo Multisample.

 Some Multisamples may have an upper limit to their keyboard range, over which they may not produce any sound.

*Note:* if the stored selection uses EXs or User Sample Bank data which is not currently loaded, it will not make any sound. As an indication of this, the name will be shown in red. The message “Samples Not Loaded” will also appear at the top of the display. To fix this, load the required sample data.

### Multisample Select menu

To select a Multisample:

1. Press the Multisample Select popup button to open the Multisample select menu.
2. Use the tabs to select a category and sub-category.
3. Select a Multisample from within that category/sub-category.
4. Press the OK button to confirm your selection, or press the Cancel button to exit without making a change.

The list shows all of the mono Multisamples in the Bank. If the Bank contains stereo multisamples, you'll also see the left and right channels as separate, mono multisamples, with -L and -R appended to the end of the name.

### Reverse [Off, On]

This lets you play the selected multisample backwards, without looping.

*Note:* If the individual samples within a Multisample are already set to Reverse, they will still play in reverse, regardless of this setting.

*Note:* Reverse is not available for EXs Multisamples loaded using Virtual Memory. To use reverse with EXs data, set the Load Method to RAM. For more information, see "Change load method" on page 766.

**On (checked):** The Multisample will play back in reverse.

**Off (unchecked):** The Multisample will play back normally.

### Level [0...127]

This sets the basic volume level of the multisample. Use this to adjust the balance between the four velocity zones.

The Excitation Mixer, main Mixer, and Amp sections can modify this basic level extensively with envelopes, LFOs, keyboard tracking, and other modulation; for more information, see "4-4: Excitation Mixer," on page 259, "4-9: Mixer," on page 272, and "6-1: Amp," on page 283.

 Depending on the multisample, high **Level** settings may cause distortion when playing many notes at a time. If this occurs, lower the **Level**.

With Sampling Mode Multisamples, each Sample also has a "+12dB" option. If this is turned on, the Sample will play back approximately 12dB louder. You can configure this parameter for each Sample in Sampling mode. For more information, see "+12dB" on page 701.

### Start Offset [Off, 1st...8th]

In addition to simply starting playback from the beginning, ROM and EXs Multisamples can have up to 8 different pre-programmed alternate starting points.

Similarly, Sampling Mode and User Sample Bank Multisamples can play either from the beginning of the waveform, or from the loop start point.

#### Start Offsets: ROM and EXs

With ROM and EXs Multisamples, the Start Offset specifies whether to use the normal start point (**Off**), or to use one of the alternate start points (**1st–8th**).

Some ROM and EXs Multisamples may have fewer than 8 pre-programmed points, in which case only the available points can be selected.

#### Start Offsets: Sampling Mode and User Sample Banks

With Sampling Mode and User Sample Bank Multisamples, only Off and 1st are available. **Off** uses the normal start point, and **1st** uses the loop start instead. **2nd** through **8th** will be grayed out.

### Bottom Velocity [1...127]

This sets the lowest velocity at which the Multisample or will sound. MS1's Bottom Velocity can be equal to, but not lower than, than that of MS2.

#### MS2...3 and MS4 (Low)

These are the settings for the remaining velocity zones. The parameters for MS2 and MS3 are exactly the same as those for "MS1 (High)," above.

The parameters for MS4 (Low) are also similar to those for MS1, except that MS4 has no setting for Bottom Velocity (which is always fixed at 1).

---

## ▼ 4-2: Page Menu Commands

The number before each command shows its ENTER + number-key shortcut. For more information on these shortcuts, see "ENTER + 0-9: shortcuts for menu commands" on page 147.

- 0: **Write Program.** For more information, see "Write Program" on page 147.
- 1: **Exclusive Solo.** For more information, see "Exclusive Solo" on page 147.
- 2: **Remap MS/Sample Banks.** For more information, see "Remap MS/Sample Banks" on page 163.

## 4-3: PCM Oscillator Pitch

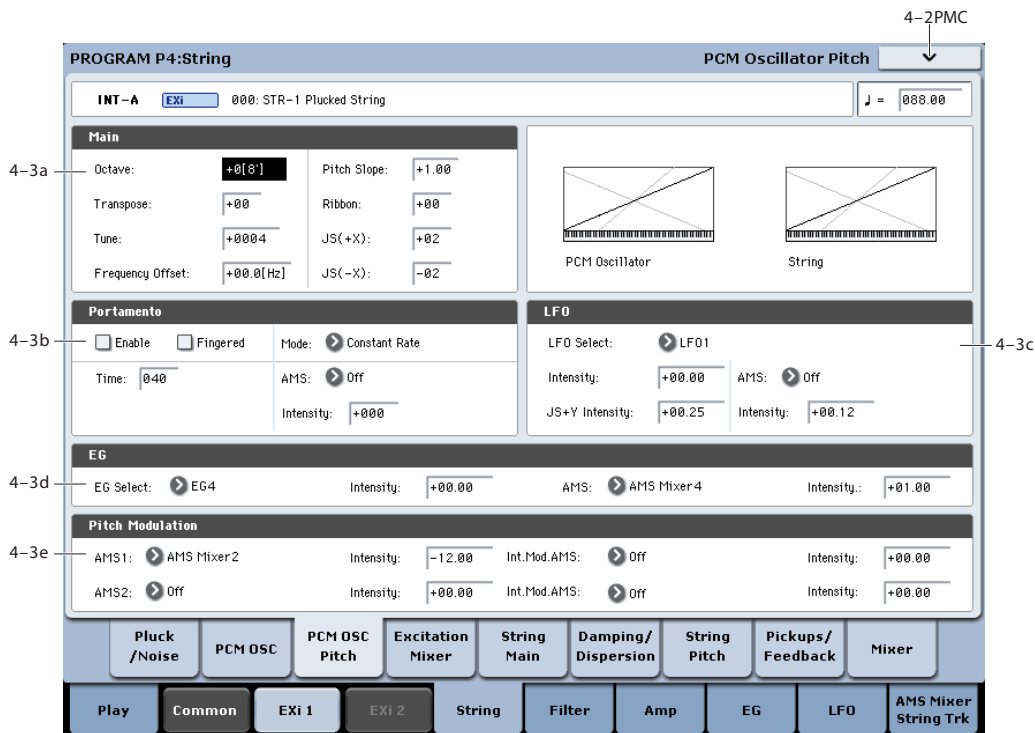

This section controls the pitch modulation for the PCM oscillator.

**Important:** when using the PCM Oscillator as an excitation for the string, the “pitch” of the PCM will affect the *timbre* of the string, and not the pitch of the overall sound.

On the other hand, when the string is used as a resonator or comb filter (by setting the string’s **Decay** and **Damping** to moderate values), the PCM Oscillator *will* control the overall pitch of the sound.

### 4-3a: Main

**Octave** [-2[32’], -1[16’], +0[8’], +1[4’]]

This sets the basic pitch of the PCM Oscillator, in octaves. The default is +0[8’].

**Transpose** [-12...+12]

This adjusts the pitch in semitones, over a range of  $\pm 1$  octave.

**Tune** [-1200...+1200]

This adjusts the pitch in cents, over a range of  $\pm 1$  octave. A cent is 1/100 of a semitone.

**Frequency Offset** [-10.0Hz ... +10.0Hz]

This adjusts the pitch by increments of 0.1 Hz.

**Frequency Offset** is different from **Tune** in that, when used to detune the two oscillators, it can create a constant beat frequency across the range of the keyboard.

**Pitch Slope** [-1.00...+0.00...+2.00]

Normally, this should be set to the default of +1.00.

**Positive (+)** values cause the pitch to rise as you play higher on the keyboard, and **negative (-)** values cause the pitch to *fall* as you play higher on the keyboard.

When this is set to 0, playing different notes on the keyboard won’t change the pitch at all; it will be as if you’re always playing C4. This can be useful for special effects sounds, for instance.

If you want to create more complex effects, you can use one of the Key Track generators as a source for Pitch Modulation AMS.

**Ribbon** [-60...+60 semitones]

You can use the ribbon controller for pitch-bend. This parameter specifies, in semitones, the ribbon’s pitch-bend range.

**Positive (+)** values make the pitch rise when you press the ribbon controller to the right of center, and **negative (-)** values will cause the pitch to fall.

When you lift off of the ribbon, the pitch will snap back to the center (unless you’re using the SW1/2 “Ribbon Lock” feature). So, by tapping on the right edge of the ribbon and then releasing quickly, you can create guitar-style “hammer-on” effects.

**JS+X** [-60...+60 semitones]

This sets the maximum amount of pitch bend, in semitones, when you move the joystick to the right. For normal pitch bend, set this to a positive value.

**JS-X** [-60...+60 semitones]

This sets the maximum amount of pitch bend, in semitones, when you move the joystick to the left. For normal pitch bend, set this to a negative value.



### 4-3b: Portamento

Portamento lets the pitch glide smoothly between notes, instead of changing abruptly.

#### Portamento and MIDI

If Portamento is either enabled for both the String and the PCM, or off for both, then MIDI CCs 5 (Portamento Time) and 65 (Portamento on/off) affect both the String and the PCM.

If Portamento is enabled for only one of the two, only that element can be affected by the MIDI CCs. The other element will always have Portamento off, regardless of the MIDI CCs.

#### Enable [Off, On]

**On (checked):** Turns on Portamento, so that pitch glides smoothly between notes.

**Off (unchecked):** Turns off Portamento. This is the default state.

#### Fingered [Off, On]

This parameter allows you to control Portamento through your playing style. When it's enabled, playing legato will turn on Portamento, and playing detached will turn it off again.

This option is only available when Portamento Enable is turned on.

**On (checked):** Turns on Fingered Portamento.

**Off (unchecked):** Turns off Fingered Portamento.

#### Mode [Constant Rate, Constant Time]

Constant Rate means that Portamento will always take the same amount of time to glide a given distance in pitch - for instance, one second per octave. Put another way, gliding several octaves will take much longer than gliding a half-step.

Constant Time means that Portamento will always take the same amount of time to glide from one note to another, regardless of the difference in pitch. This is especially useful when playing chords, since it ensures that each note in the chord will end its glide at the same time.

#### Time [000...127]

This controls the portamento time. Higher values mean longer times, for slower changes in pitch. When **Time** is set to 0, the pitch will be reached instantly—just as if Portamento **Enable** was turned **Off**.

#### AMS [List of AMS Sources]

This selects an AMS source to control the **Portamento Time**. For a list of AMS sources, see "Alternate Modulation Source (AMS) List" on page 1091.

The modulation occurs only at note-on. This means that you can change the time for the *next* pitch glide, but you can't change any glides which are already in progress.

#### Intensity [-127...+127]

This controls the depth and direction of the **Portamento Time** AMS modulation.

### 4-3c: LFO

#### LFO Select [LFO 1, LFO 2, LFO 3, LFO 4, Common LFO]

This selects an LFO to modulate the PCM Oscillator's pitch.

The **LFO Intensity**, **JS+Y Intensity**, and **AMS** are all summed together to produce the final amount of LFO pitch modulation.

#### LFO Intensity [-48.00...+48.00]

This controls the initial effect of the LFO on the pitch, in semitones, before any JS+Y or AMS modulation.

**Negative (-)** settings will invert the phase of the LFO.

Both the String and PCM Pitch LFO Intensities are scaled by MIDI CC#77.

#### JS+Y Intensity [-48.00...+48.00]

Moving the joystick "up" from the center detent position, away from yourself, produces the JS+Y controller. You can use this to scale the amount of the LFO applied to the pitch. This parameter sets the maximum amount of LFO modulation added by JS+Y, in semitones.

As this value is **increased**, moving the joystick in the +Y direction will cause the LFO to produce deeper pitch modulation.

**Negative (-)** settings will invert the phase of the LFO. You can also use this to reduce the initial amount of the LFO, as set by **LFO1 Intensity**, above.

#### AMS [AMS Sources]

This selects an AMS modulation source to scale the amount of the LFO applied to pitch.

For a list of AMS sources, see "Alternate Modulation Source (AMS) List" on page 1091.

#### Intensity [-48.00...+48.00]

This controls the depth and direction of the LFO AMS modulation, in semitones.

### 4-3d: Pitch EG

#### EG Select [EG 1 (Filter), EG 2 (Pitch), EG 3, EG 4, Amp EG]

This selects an EG to modulate the PCM Oscillator pitch.

There are four assignable EGs, in addition to the Amp EG. Each of these can be used as a modulation source to control a wide variety of parameters.

In the midst of all this flexibility, we thought it would also be good to provide a little structure. With this in mind, EG 1 is named EG 1 (Filter) and EG 2 is labeled EG 2 (Pitch).

Please take these names as suggestions, rather than restrictions. If you like, you're free to use these EGs to control any EG or AMS destination, or to use other EGs to control Filter Frequency and Pitch.

**Intensity** [-48.00...+48.00]

This controls the initial effect of the Pitch EG on the PCM Oscillator, in half-steps, before any AMS modulation.

The Pitch EG's shape can swing all the way from +99 to -99. When the Intensity is set to a **positive (+)** value, positive values from the EG raise the pitch, and negative values lower the pitch.

When the Intensity is set to a **negative (-)** value, the effect of the EG is reversed; positive EG values mean *lower* pitches, and negative EG values mean *higher* pitches.

**AMS** [AMS Sources]

This selects an AMS modulation source to scale the amount of the Pitch EG applied to the PCM Oscillator.

For a list of AMS sources, see "Alternate Modulation Source (AMS) List" on page 1091.

**Intensity** [-48.00...+48.00]

This controls the depth and direction of the pitch EG AMS modulation. The AMS modulation and the initial Intensity are added together to determine the Pitch EG's final effect.

---

**4-3e: Pitch Modulation****AMS 1** [List of AMS Sources]

This selects the first modulation source for controlling the PCM Oscillator's pitch. For a list of AMS sources, see "Alternate Modulation Source (AMS) List" on page 1091.

**Intensity** [+/-48.00 semitones]

This controls the depth and direction of the AMS 1 pitch modulation, in semitones.

**Intensity Mod AMS** [List of AMS Sources]

You can modulate AMS 1's Intensity from another AMS source. This selects that source.

**Intensity** [+/-48.00 semitones]

This controls the depth and direction of the Intensity Mod AMS, in semitones. The result is summed with the main AMS 1 Intensity to produce the final pitch modulation amount.

**AMS 2** [List of AMS Sources]

This selects a second modulation source for controlling the PCM Oscillator's pitch. For a list of AMS sources, see "Alternate Modulation Source (AMS) List" on page 1091.

**Intensity** [+/-48.00 semitones]

This controls the depth and direction of the AMS 2 pitch modulation, in semitones.

**Intensity Mod AMS** [List of AMS Sources]

You can modulate AMS 2's Intensity from another AMS source. This selects that source.

**Intensity** [+/-48.00 semitones]

This controls the depth and direction of the Intensity Mod AMS, in semitones. The result is summed with the main AMS 2 Intensity to produce the final pitch modulation amount.

---

**▼ 4-3: Page Menu Commands**

The number before each command shows its ENTER + number-key shortcut. For more information on these shortcuts, see "ENTER + 0-9: shortcuts for menu commands" on page 147.

- **0: Write Program.** For more information, see "Write Program" on page 147.
- **1: Exclusive Solo.** For more information, see "Exclusive Solo" on page 147.

## 4-4: Excitation Mixer

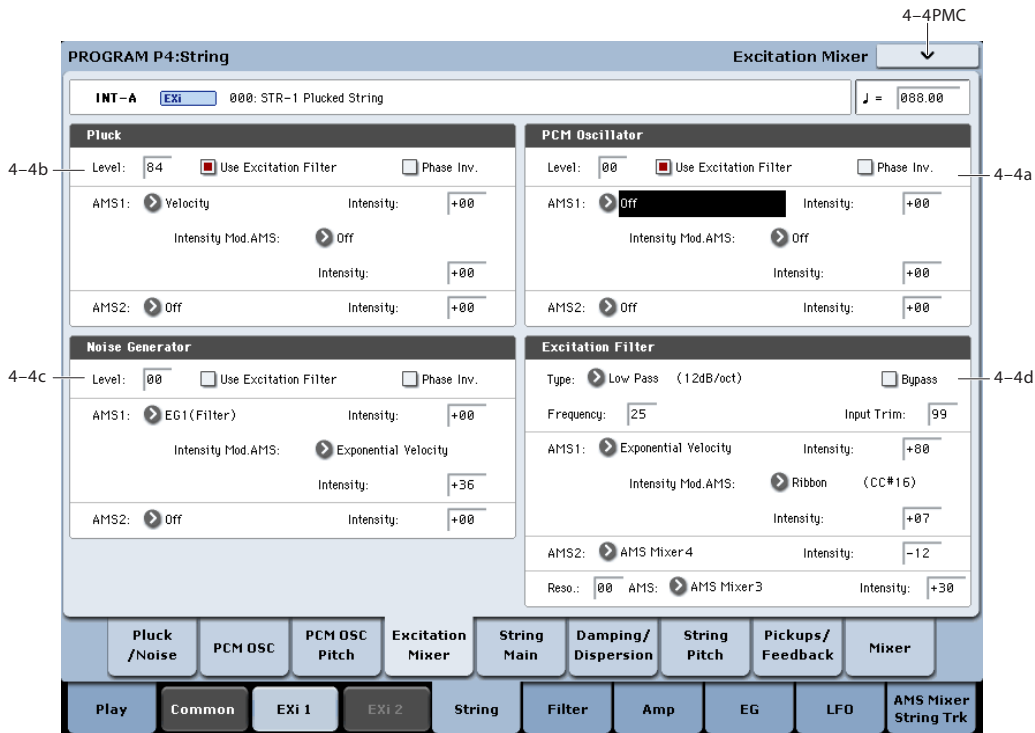

### 4-4a: PCM Oscillator

**Level** [0...100]

This controls the PCM Oscillator's input level to the String.

**Phase Invert** [Off, On]

This inverts the phase of the PCM Oscillator's input to the String. If you use two inputs, and one has an inverted phase, it's as if they were pushing the string in opposite directions.

**Use excitation filter** [Off, On]

This check-box sets whether or not the signal goes through the Excitation Filter, which controls the tone of the signal going into the string.

**AMS 1** [List of AMS Sources]

This selects the first modulation source to control the **PCM Oscillator Level**. For a list of AMS sources, see "Alternate Modulation Source (AMS) List" on page 1091.

**Intensity** [-100...+100]

This controls the depth and direction of the **PCM Oscillator Level** AMS modulation.

**Intensity Mod AMS** [List of AMS Sources]

This selects an AMS source to modulate the intensity of AMS 1.

**Intensity** [-100...+100]

This controls the depth and direction of the **Intensity Mod AMS**.

**AMS 2** [AMS Sources]

This selects a second modulation source to control the **PCM Oscillator Level**. For a list of AMS sources, see "Alternate Modulation Source (AMS) List" on page 1091.

**Intensity** [-100...+100]

This controls the depth and direction of **AMS 2**.

### 4-4b: Pluck

These parameters control the Pluck Table's input level to the String. They are identical to those for the PCM Oscillator; for more information, see "4-4a: PCM Oscillator" on page 259.

### 4-4c: Noise Generator

These parameters control the Noise Generator's input level to the String. They are identical to those for the PCM Oscillator; for more information, see "4-4a: PCM Oscillator" on page 259.

### 4-4d: Excitation Filter

This is a 2-pole, resonant multimode filter, for tailoring the excitation to the string.

**Note:** MIDI CCs 74 (Cutoff) and 71 (Resonance) do not affect this filter.

**Filter Type** [Low Pass, High Pass, Band Pass, Band Reject]

The filter will produce very different results depending on the selected filter type.

**Low Pass.** This cuts out the parts of the sound which are **higher** than the cutoff frequency. Low Pass is the most common type of filter, and is used to make bright timbres sound darker.

**High Pass.** This cuts out the parts of the sound which are **lower** than the cutoff frequency. You can use this to make timbres sound thinner or more buzzy.

**Band Pass.** This cuts out all parts of the sound, both highs and lows, except for the region around the cutoff frequency. Since this filter cuts out both high and low frequencies, its effect can change dramatically depending on the cutoff setting and the oscillator's multisample.

With low resonance settings, you can use the Band Pass filter to create telephone or vintage phonograph sounds. With higher resonance settings, it can create buzzy or nasal timbres.

**Band Reject.** This filter type—also called a notch filter—cuts only the parts of the sound directly around the cutoff frequency. Try modulating the cutoff with an LFO to create phaser-like effects.

*Filter Types and Cutoff Frequency*

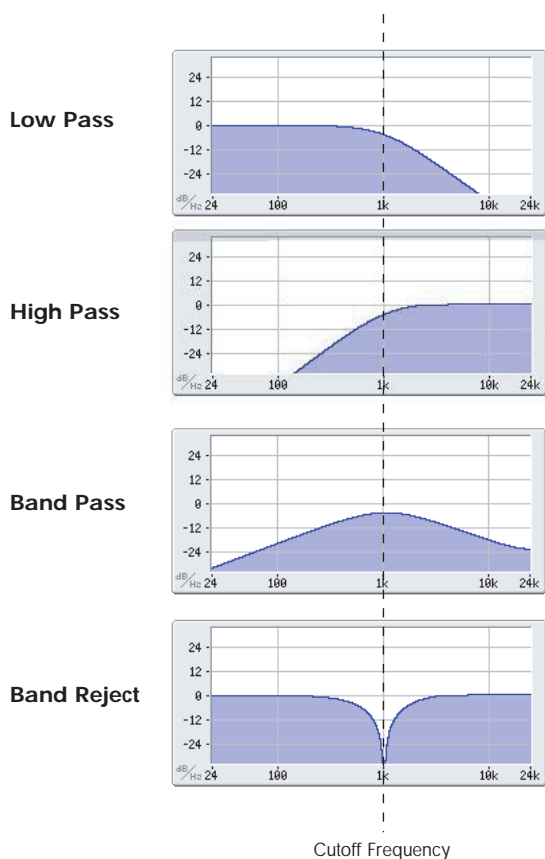

**Bypass** [Off, On]

This lets you bypass the filter completely.

If **Bypass** is **Off**, the filter functions normally.

When **Bypass** is **On**, the filter has no effect on the excitation signal.

**Trim** [00...100]

This adjusts the volume level at the input to the filter. If you notice that the sound is distorting, especially with high Resonance settings, you can turn the level down here.

Note that the filter will not clip internally.

**Frequency** [00...100]

This controls the cutoff frequency of Filter A, in increments of 1/10 of an octave. The specific effect of the cutoff frequency will change depending on the selected **Filter Type**, as described above.

**AMS 1** [List of AMS Sources]

This selects the first modulation source for controlling the **Frequency**. For a list of AMS sources, see “Alternate Modulation Source (AMS) List” on page 1091.

**Intensity** [-100...+100]

This controls the depth and direction of the AMS 1 **Frequency** modulation.

**Intensity Mod AMS** [List of AMS Sources]

You can modulate AMS 1’s Intensity from another AMS source. This selects that source.

**Intensity** [-100...+100]

This controls the depth and direction of the Intensity Mod AMS. The result is summed with the main AMS 1 Intensity to produce the final **Frequency** modulation amount.

**AMS 2** [List of AMS Sources]

This selects a second modulation source for controlling the **Frequency**. For a list of AMS sources, see “Alternate Modulation Source (AMS) List” on page 1091.

**Intensity** [-100...+100]

This controls the depth and direction of the AMS 2 **Frequency** modulation.

**Resonance** [00...100]

Resonance emphasizes the frequencies around the cutoff frequency.

When this is set to **0**, there is no emphasis, and frequencies beyond the cutoff will simply diminish smoothly.

At medium settings, the resonance will alter the timbre of the filter, making it sound more nasal, or more extreme.

At very high settings, the resonance can be heard as a separate, whistling pitch.

To make the resonance track the keyboard pitch, see “Key Follow,” on page 280.

**AMS** [AMS Sources]

This selects a modulation source to control the **Resonance** amount. For a list of AMS sources, see “Alternate Modulation Source (AMS) List” on page 1091.

**Intensity** [-100...+100]

This controls the depth and direction of the **Resonance** modulation.

▼ 4-4: Page Menu Commands

The number before each command shows its ENTER + number-key shortcut. For more information on these shortcuts, see “ENTER + 0-9: shortcuts for menu commands” on page 147.

- 0: **Write Program**. For more information, see “Write Program” on page 147.
- 1: **Exclusive Solo**. For more information, see “Exclusive Solo” on page 147.

4-5: String Main

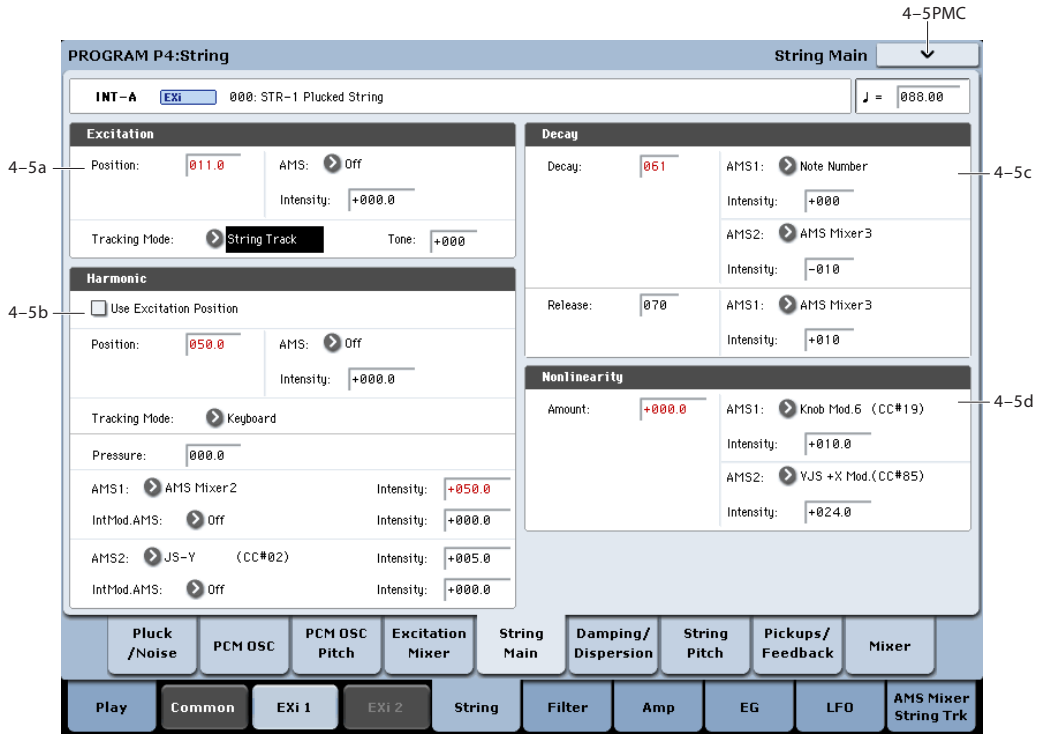

4-5a: Excitation

The **Excitation** is the force that makes the string start to vibrate. For a physical string, this might be a guitar pick, a fingernail, a hammer on a clavinet, a plectrum on a harpsichord, and so on.

**Position** [0...100.0]

This models the position of the excitation (such as the pluck) along the string, which has a strong effect on the timbre.

**Important:** the **Tone** parameter, below, must be non-zero in order for **Position** to have any effect.

**0.0** is one end of the string, at the bridge; **100.0** is the other end of the string, at the nut (just before the headstock). Usually, values between 8.0 and 25.0 should work well.

**50.0** is the middle of the string. The timbres of different values are approximately symmetric around this position, except for very near the ends of the string. In other words, 60.0 produces a similar timbre to 40.0, 75.0 is similar to 25.0, and so on. The delay between the excitation and the pickups will change, however.

Excitation Position

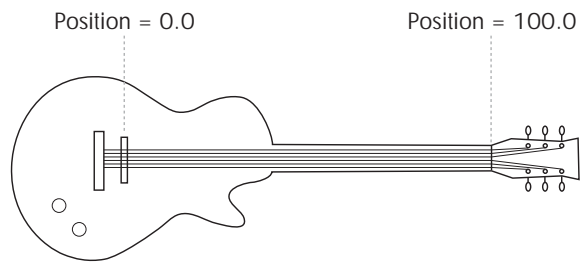

**How Position affects the timbre**

Depending upon the **Position**, some overtones will be emphasized, and others de-emphasized. At specific positions, certain overtones will disappear completely, as detailed below.

You can also think of the **Position** as a fraction of the total string length. For instance, 50.0 means that the excitation is half-way along the string; 33.3 means that excitation is 1/3 of the way along the string; 25.0 is 1/4 of the way along the string, and so on.

Reaching back into math class for a moment, the number under the fraction is called the denominator. For instance, the denominator of 1/5 is 5.

As a rule of thumb, harmonics which are multiples of the denominator will be silent. For instance, if the **Position** is set to 20.0, the ratio is 1/5, and so every fifth harmonic will be silent: 5, 10, 15, etc. This is like a comb filter, with successive, evenly-spaced notches.

The graphic below shows the shape of this comb filter, and the resulting basic harmonic structure. (Comb filters are named because their shape looks a little like the teeth of a comb.)

*Harmonic structure with Position = 20.0 (ratio = 1/5)*

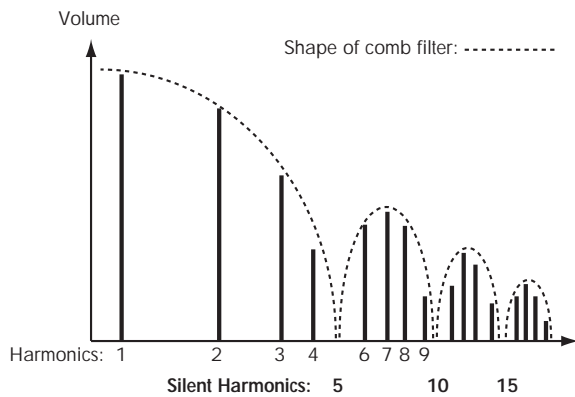

The table below shows a few more settings which cancel out specific harmonics:

*Effect of Excitation Position on harmonic structure*

Position	Ratio of string length	Effect
50.0	1/2	Odd harmonics are silent, like a square-wave.
33.3	1/3	Every third harmonic is silent: 3, 6, 9 etc.
25.0	1/4	Every fourth harmonic is silent: 4, 8, 12 etc.
20.0	1/5	Every fifth harmonic is silent: 5, 10, 15 etc.

You can also adjust the positions of the two Pickups, which produce similar comb filtering effects. (For more information, see “4-8a: Pickup 1” on page 270.) The filtering produced by the excitation position and the two pickups is cumulative, and can produce complex patterns of peaks and valleys in the overall frequency response.

**AMS [List of AMS Sources]**

This selects a modulation source to control the **Position**. Modulation is applied only at note-on; while the note is sounding, changing the modulation has no effect. For a list of AMS sources, see “Alternate Modulation Source (AMS) List” on page 1091.

**Intensity [-100.0...+100.0]**

This controls the depth and direction of the **Position** modulation.

**Tracking Mode [String Track, Keyboard]**

This controls the relationship between the pickup **Position** and the pitch.

**String Track** scales the position according to the current String, as set in the String Track section.

**Keyboard** scales the position according to pitch, without taking the String settings into account. This might be more appropriate for clav sounds, for instance.

**Tone [-100...+100]**

This controls the affect of the **Position** on the overall tone. When **Tone** is set to 0, **Position** has no effect.

-100 is generally the most realistic, although other settings may give good results depending on the particular excitation signal. -100 also works well to counteract the low-end “thump” which can be caused by low-frequency excitation signals, including plucks with very low (or negative) **Width** values.

Other **Tone** settings will make the comb filter described under **Position**, above, work differently. Settings between -100 and 0 will reduce the effect of the filter, until—at 0—it has no effect at all. Positive settings will make the filter work in reverse, reinforcing harmonics instead of eliminating them.

**What does Tone do?**

When you pluck a real string, the string vibrates outward in both directions from the excitation position. These two vibrations bounce off their respective ends of the string, return in the opposite direction, and interact with each other along the way, affecting the timbre of the string.

In the real world, this can't be changed—but the Tone parameter lets you bend the physics a bit. This is useful, in part, because some of the things you can use to “pluck” the string—such as a PCM sample—aren't things you could use in the real world, either. The Tone parameter gives you another tool adjust the way that these unusual excitations affect the timbre.

Put simply, Tone lets you pluck the same string twice, in the same place, with the waves from each pluck moving in only one direction. One of these plucks—think of it as the one that moves the wave “forward”—always works in the physical way. Tone controls the pluck that moves the wave “backwards.”

*“Plucking” the string with different Tone settings*

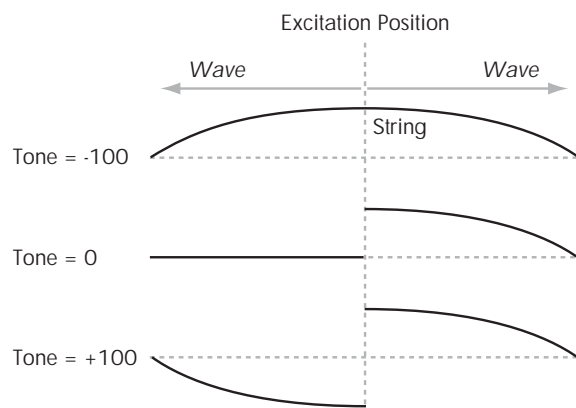

### 4-5b: Harmonic

This models pressing down lightly (or firmly) in the middle of the string, like playing harmonics on a guitar.

**Use Excitation Position** [Check-box]

This makes the harmonic use the same position as the excitation, including AMS modulation. Using this option creates an interesting hybrid pluck/chime timbre.

When this is checked, the rest of the Position parameters will be grayed out.

**Position** [0...100.0]

This controls the position at which the string is being pressed down. As when playing harmonics on a real string, the harmonic will be loudest when the position aligns with the harmonic series.

When the Harmonic **Tracking Mode** is set to **Keyboard**, it's easy to make the position match a specific harmonic, as shown below. When **Tracking Mode** is set to **String**, the values below are correct for the open-string notes only; on other notes, the harmonics will line up with slightly higher values.

*Harmonic Position and the Harmonic Series, when Tracking Mode = Keyboard*

Position Value	Harmonic	Pitch
100.0	Fundamental	Unison
50.0	1st	1 octave up
33.3	2nd	1 octave + fifth
25.0	3rd	2 octaves up
20.0	4th	2 octaves + maj. third
16.6	5th	2 octaves + fifth
14.2	6th	2 octaves + flat seventh
12.5	7th	3 octaves up

If **Use Excitation Position** is On, this parameter is grayed out.

**AMS** [List of AMS Sources]

This selects a modulation source to control the **Position**. For a list of AMS sources, see "Alternate Modulation Source (AMS) List" on page 1091.

If **Use Excitation Position** is On, this parameter is grayed out.

**Intensity** [-100.0...+100.0]

This controls the depth and direction of the **Position** modulation.

If **Use Excitation Position** is On, this parameter is grayed out.

**Tracking Mode** [String Track, Keyboard]

This controls the relationship between the harmonic **Position** and the pitch.

**String Track** scales the position according to the current String, as set in the String Track section.

**Keyboard** scales the position according to pitch, without taking the String settings into account. This might be more appropriate for clav sounds, for instance.

If **Use Excitation Position** is On, this parameter is grayed out.

**Pressure** [0.0...100.0]

This controls how hard the string is being pressed down. Non-zero settings can create interesting special effects—but for standard use, this should be left at 0.0, and then modulated via AMS. For instance:

1. Follow the instructions under "Creating an initialized STR-1 Program" on page 254.
2. Assign EG3 to Harmonic AMS1, and set the Intensity to +100.0.
3. On the EG3 page (P7-3), set the Break and Sustain levels to +00.
4. Adjust the Decay Time between 0 and 20, and listen to the way the sound changes.

This controls the amount of time that the string is being pressed down. As you increase this time, the harmonic tone will become more and more prominent. Around 18-20, the harmonic tone takes over completely. As you increase from 20 to 50, the tone becomes more pure, and less bright.

**AMS 1** [List of AMS Sources]

This selects the first modulation source to control the **Pressure**. Often, it will make sense to use an envelope here. For a list of AMS sources, see "Alternate Modulation Source (AMS) List" on page 1091.

**Intensity** [-100.0...+100.0]

This controls the depth and direction of the **Pressure** modulation.

**Intensity Mod AMS** [AMS Sources]

This selects a AMS modulation source to scale the intensity of **Pressure AMS 1**. For a list of AMS sources, see "Alternate Modulation Source (AMS) List" on page 1091.

**Intensity** [-100.0...+100.0]

This controls the depth and direction of the **Intensity Mod AMS**. Even if the main AMS **Intensity** is set to 0, **Intensity Mod AMS** can still control the final amount of AMS over the full +/-100 range.

**AMS 2** [List of AMS Sources]

This selects the second modulation source to control the **Pressure**. For a list of AMS sources, see "Alternate Modulation Source (AMS) List" on page 1091.

**Intensity** [-100.0...+100.0]

This controls the depth and direction of the **Pressure** modulation.

**Intensity Mod AMS** [AMS Sources]

This selects a AMS modulation source to scale the intensity of **Pressure AMS 2**. For a list of AMS sources, see "Alternate Modulation Source (AMS) List" on page 1091.



**Intensity** [-100.0...+100.0]

This controls the depth and direction of the **Intensity Mod AMS**. Even if the main AMS **Intensity** is set to 0, **Intensity Mod AMS** can still control the final amount of AMS over the full +/-100 range.

**4-5c: Decay****Decay** [0...100]

This controls the overall decay time of the string without affecting frequency content. This interacts with **Damping**, which controls the decay time for high frequencies. For more information, see “4-6a: Damping” on page 265.

**Note:** the **Amp EG** still controls the output level of the STR-1 as a whole, so the final decay time will be a combination of the **String Decay** and the **Amp EG**. As a general rule, the **Amp EG** can make the overall decay time shorter than the **String Decay**, but not longer.

For instance, if the **String Decay** is set to a high value (for a long decay), but the **Amp EG Decay** is short, the final result will be a short decay.

For more information, see “6-3: Amp EG” on page 286.

**AMS 1** [List of AMS Sources]

This selects the first modulation source to control the **Decay**. For a list of AMS sources, see “Alternate Modulation Source (AMS) List” on page 1091.

**Intensity** [-100...+100]

This controls the depth and direction of **AMS1**.

**AMS 2** [List of AMS Sources]

This selects a second modulation source to control the **Decay**. For a list of AMS sources, see “Alternate Modulation Source (AMS) List” on page 1091.

**Intensity** [-100...+100]

This controls the depth and direction of **AMS 2**.

**Release** [0...100]

This sets the overall release time for the string—the time that it takes to fade away after note-off.

**Note:** the **Amp EG** still controls the output level of the STR-1 as a whole, so the final release time will be a combination of the **String Release** and the **Amp EG**. For more information, see “Decay,” above.

**AMS** [List of AMS Sources]

This selects a modulation source to control the **Release**. For a list of AMS sources, see “Alternate Modulation Source (AMS) List” on page 1091.

**Intensity** [-100...+100]

This controls the depth and direction of the **Release** modulation.

**4-5d: Nonlinearity****Amount** [-100.0...100.0]

This models the instability of the string’s bridge. Greater nonlinearity means a less rigid bridge. At higher levels, this causes the characteristic buzzing sound of some non-western stringed instruments, such as the sitar.

**AMS1** [List of AMS Sources]

This selects the first modulation source to control the **Nonlinearity**. For a list of AMS sources, see “Alternate Modulation Source (AMS) List” on page 1091.

**Intensity** [-100.0...+100.0]

This controls the depth and direction of the **Nonlinearity** modulation.

**AMS2** [List of AMS Sources]

This selects a second modulation source to control the **Nonlinearity**. For a list of AMS sources, see “Alternate Modulation Source (AMS) List” on page 1091.

**Intensity** [-100.0...+100.0]

This controls the depth and direction of the second **Nonlinearity** modulation.

**▼ 4–5: Page Menu Commands**

The number before each command shows its ENTER + number-key shortcut. For more information on these shortcuts, see “ENTER + 0-9: shortcuts for menu commands” on page 147.

- **0: Write Program.** For more information, see “Write Program” on page 147.
- **1: Exclusive Solo.** For more information, see “Exclusive Solo” on page 147.

## 4-6: Damping and Dispersion

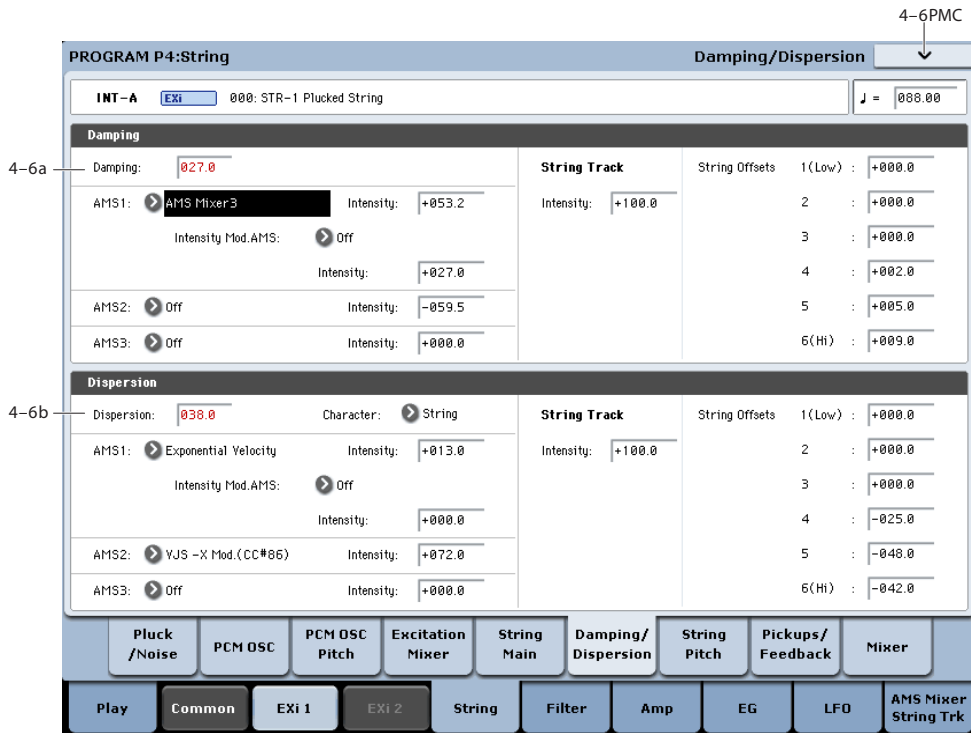

### 4-6a: Damping

#### Damping [0...100.0]

This controls the decay time for the string's high frequencies. Higher settings mean a shorter high frequency decay time, for a bright attack and a more mellow sustained tone. Lower settings let the string ring brightly for a longer period of time.

**Damping** interacts with the **Decay** parameter, which controls the overall decay time. For more information, see "4-5c: Decay" on page 264.

To create a comb-filtered effect with PCM or audio input, instead of a string model, set **Damping** to a moderate value.

#### AMS 1 [List of AMS Sources]

This selects the first modulation source to control the **Damping**. For a list of AMS sources, see "Alternate Modulation Source (AMS) List" on page 1091.

#### Intensity [-100.0...+100.0]

This controls the depth and direction of the **Damping** AMS modulation.

#### Intensity Mod AMS [List of AMS Sources]

This selects an AMS source to modulate the intensity of **AMS 1**.

#### Intensity [-100.0...+100.0]

This controls the depth and direction of the **Intensity Mod AMS**.

#### AMS 2 [List of AMS Sources]

This selects a second modulation source to control the **Damping**. For a list of AMS sources, see "Alternate Modulation Source (AMS) List" on page 1091.

#### Intensity [-100.0...+100.0]

This controls the depth and direction of **AMS 2**.

#### AMS 3 [List of AMS Sources]

This selects a third modulation source to control the **Damping**. For a list of AMS sources, see "Alternate Modulation Source (AMS) List" on page 1091.

#### Intensity [-100.0...+100.0]

This controls the depth and direction of **AMS 3**.

#### String Track

#### String Track Intensity [-100.0...+100.0]

This controls the overall depth and direction of **String Tracking's** effect on the **Damping**. You can adjust the offsets for each string using the **Strings 1...6** parameters, as described below.

#### String 1...6 AMSource [-100.0...+100.0]

These set the individual **Damping** offsets for the six Strings, as set under "9-9b: Strings" on page 291. These values are also available for modulating other parameters via AMS; they appear in the AMS list as **Damping String Track**.

---

## 4-6b: Dispersion

### Dispersion [0...100.0]

This models the rigidity of the string. Higher values correspond to thicker-gauge strings, and increase the inharmonicity of the string. ("Inharmonicity" means that the pitches of the overtones become out of tune with the fundamental.) At extreme values, it will create bell-like timbres, as if you were hitting a bar of metal.

**Dispersion** can be modulated by three AMS sources, which are added to the Dispersion setting.

### Character [Bell, String]

This changes the way that the upper harmonics become detuned as **Dispersion** is increased.

With the **Bell** setting, as you increase the **Dispersion** amount, the lower harmonics will go out of tune gradually, but the upper harmonics will do so very steeply. The higher the harmonic, the more out-of-tune it will become. The resulting inharmonicity is similar to the sound of a bell.

With the **String** setting, the upper harmonics will still become more out of tune than the lower harmonics, but with a more gradual slope. Up to moderately high **Dispersion** settings, this retains a string-like character.

### AMS 1 [List of AMS Sources]

This selects the first modulation source to control the **Dispersion**. For a list of AMS sources, see "Alternate Modulation Source (AMS) List" on page 1091.

### Intensity [-100.0...+100.0]

This controls the depth and direction of the **Dispersion** AMS modulation.

### Intensity Mod AMS [List of AMS Sources]

This selects an AMS source to modulate the intensity of AMS 1.

### Intensity [-100.0...+100.0]

This controls the depth and direction of the **Intensity Mod AMS**.

### AMS 2 [List of AMS Sources]

This selects a second modulation source to control the **Dispersion**. For a list of AMS sources, see "Alternate Modulation Source (AMS) List" on page 1091.

### Intensity [-100.0...+100.0]

This controls the depth and direction of AMS 2.

### AMS 3 [List of AMS Sources]

This selects a third modulation source to control the **Dispersion**. For a list of AMS sources, see "Alternate Modulation Source (AMS) List" on page 1091.

### Intensity [-100.0...+100.0]

This controls the depth and direction of AMS 3.

## String Track

### String Track Intensity [-100.0...+100.0]

This controls the overall depth and direction of **String Track's** effect on **Dispersion**. You can adjust the offsets for each individual string using the **String 1...6** parameters, as described below.

### String 1...6 AMSSource [-100...+100]

These set the individual **Dispersion** offsets for the six Strings, as set under "9-9b: Strings" on page 291. For instance, you might set the lower strings to greater values, to model typical guitar strings.

These values are also available for modulating other parameters via AMS; they appear in the AMS list as **Disp. String Track**.

---

## ▼ 4-6: Page Menu Commands

The number before each command shows its ENTER + number-key shortcut. For more information on these shortcuts, see "ENTER + 0-9: shortcuts for menu commands" on page 147.

- 0: **Write Program**. For more information, see "Write Program" on page 147.
- 1: **Exclusive Solo**. For more information, see "Exclusive Solo" on page 147.

## 4-7: String Pitch



### 4-7a: Main

**Octave** [-2[32'], -1[16'], +0[8'], +1[4']

This sets the basic pitch of the String, in octaves. The default is +0[8'].

**Transpose** [-12...+12]

This adjusts the pitch in semitones, over a range of ±1 octave.

**Tune** [-1200...+1200]

This adjusts the pitch in cents, over a range of ±1 octave. A cent is 1/100 of a semitone.

**Pitch Slope** [-1.00...+0.00...+2.00]

Normally, this should be set to the default of +1.00.

**Positive (+)** values cause the pitch to rise as you play higher on the keyboard, and **negative (-)** values cause the pitch to *fall* as you play higher on the keyboard.

When this is set to 0, playing different notes on the keyboard won't change the pitch at all; it will be as if you're always playing C4. This can be useful for special effects sounds, for instance.

If you want to create more complex effects, you can assign key tracking as an AMS source.

**Ribbon** [-60...+60 semitones]

You can use the ribbon controller for pitch-bend. This parameter specifies, in semitones, the ribbon's pitch-bend range.

**Positive (+)** values make the pitch rise when you press the ribbon controller to the right of center, and **negative (-)** values will cause the pitch to fall.

When you lift off of the ribbon, the pitch will snap back to the center (unless you're using the SW1/2 "Ribbon Lock" feature). So, by tapping on the right edge of the ribbon and then releasing quickly, you can create guitar-style "hammer-on" effects.

**JS+ X** [-60...+60 semitones]

This sets the maximum amount of pitch bend, in semitones, when you move the joystick to the right. For normal pitch bend, set this to a positive value.

**JS- X** [-60...+60 semitones]

This sets the maximum amount of pitch bend, in semitones, when you move the joystick to the left. For normal pitch bend, set this to a negative value.

### 4-7b: Portamento

Portamento lets the pitch glide smoothly between notes, instead of changing abruptly.

#### Portamento and MIDI

If Portamento is either enabled for both the String and the PCM, or off for both, then MIDI CCs 5 (Portamento Time) and 65 (Portamento on/off) affect both the String and the PCM.

If Portamento is enabled for only one of the two, only that element can be affected by the MIDI CCs. The other element will always have Portamento off, regardless of the MIDI CCs.

**Enable** [Off, On]

**On (checked):** Turns on Portamento, so that pitch glides smoothly between notes.

**Off (unchecked):** Turns off Portamento. This is the default state.

**Fingered** [Off, On]

This parameter allows you to control Portamento through your playing style. When it's enabled, playing legato will turn on Portamento, and playing detached will turn it off again.

This option is only available when Portamento Enable is turned on.

**On (checked):** Turns on Fingered Portamento.

**Off (unchecked):** Turns off Fingered Portamento.

**Mode** [Constant Rate, Constant Time]

Constant Rate means that Portamento will always take the same amount of time to glide a given distance in pitch - for instance, one second per octave. Put another way, gliding several octaves will take much longer than gliding a half-step.

Constant Time means that Portamento will always take the same amount of time to glide from one note to another, regardless of the difference in pitch. This is especially useful when playing chords, since it ensures that each note in the chord will end its glide at the same time.

**Time** [000...127]

This controls the portamento time. Higher values mean longer times, for slower changes in pitch. When **Time** is set to 0, the pitch will be reached instantly—just as if Portamento **Enable** was turned **Off**.

**AMS** [List of AMS Sources]

This selects an AMS source to control the **Portamento Time**. For a list of AMS sources, see "Alternate Modulation Source (AMS) List" on page 1091.

The modulation occurs only at note-on. This means that you can change the time for the *next* pitch glide, but you can't change any glides which are already in progress.

**Intensity** [-127...+127]

This controls the depth and direction of the **Portamento Time** AMS modulation.

**4-7c: LFO****LFO Select** [LFO 1, LFO 2, LFO 3, LFO 4, Common LFO]

This selects an LFO to modulate the String's pitch.

The **LFO Intensity**, **JS+ Y Intensity**, and **AMS** are all summed together to produce the final amount of LFO pitch modulation.

**LFO Intensity** [-48.00...+48.00]

This controls the initial effect of the LFO on the pitch, in semitones, before any JS+Y or AMS modulation.

**Negative (-)** settings will invert the phase of the LFO.

Both the String and PCM Pitch LFO Intensities are scaled by MIDI CC#77.

**JS+Y Intensity** [-48.00...+48.00]

Moving the joystick "up" from the center detent position, away from yourself, produces the JS+Y controller. You can use this to scale the amount of the

LFO applied to the pitch. This parameter sets the maximum amount of LFO modulation added by JS+Y, in semitones.

As this value is **increased**, moving the joystick in the +Y direction will cause the LFO to produce deeper pitch modulation.

**Negative (-)** settings will invert the phase of the LFO. You can also use this to reduce the initial amount of the LFO, as set by **LFO1 Intensity**, above.

**AMS** [AMS Sources]

This selects an AMS modulation source to scale the amount of the LFO applied to pitch.

For a list of AMS sources, see "Alternate Modulation Source (AMS) List" on page 1091.

**Intensity** [-48.00...+48.00]

This controls the depth and direction of the LFO AMS modulation, in semitones.

**4-7d: Pitch EG****EG Select** [EG 1 (Filter), EG 2 (Pitch), EG 3, EG 4, Amp EG]

This selects an EG to modulate the String pitch.

There are four assignable EGs, in addition to the Amp EG. Each of these can be used as a modulation source to control a wide variety of parameters.

In the midst of all this flexibility, we thought it would also be good to provide a little structure. With this in mind, EG 1 is named EG 1 (Filter) and EG 2 is labeled EG 2 (Pitch).

Please take these names as suggestions, rather than restrictions. If you like, you're free to use these EGs to control any EG or AMS destination, or to use other EGs to control Filter Frequency and Pitch.

**Intensity** [-48.00...+48.00]

This controls the initial effect of the Pitch EG on the String, in half-steps, before any AMS modulation.

The Pitch EG's shape can swing all the way from +99 to -99. When the Intensity is set to a **positive (+)** value, positive values from the EG raise the pitch, and negative values lower the pitch.

When the Intensity is set to a **negative (-)** value, the effect of the EG is reversed; positive EG values mean *lower* pitches, and negative EG values mean *higher* pitches.

**AMS** [AMS Sources]

This selects an AMS modulation source to scale the amount of the Pitch EG applied to the String.

For a list of AMS sources, see "Alternate Modulation Source (AMS) List" on page 1091.

**Intensity** [-48.00...+48.00]

This controls the depth and direction of the pitch EG AMS modulation. The AMS modulation and the initial Intensity are added together to determine the Pitch EG's final effect.

---

## 4-7e: AMS

### AMS 1 [List of AMS Sources]

This selects the first modulation source for controlling the String's pitch. For a list of AMS sources, see "Alternate Modulation Source (AMS) List" on page 1091.

### Intensity [+/-48.00 semitones]

This controls the depth and direction of the AMS 1 pitch modulation, in semitones.

### Intensity Mod AMS [List of AMS Sources]

You can modulate AMS 1's Intensity from another AMS source. This selects that source.

### Intensity [+/-48.00 semitones]

This controls the depth and direction of the Intensity Mod AMS, in semitones. The result is summed with the main AMS 1 Intensity to produce the final pitch modulation amount.

### AMS 2 [List of AMS Sources]

This selects a second modulation source for controlling the String's pitch. For a list of AMS sources, see "Alternate Modulation Source (AMS) List" on page 1091.

### Intensity [+/-48.00 semitones]

This controls the depth and direction of the AMS 2 pitch modulation, in semitones.

### Intensity Mod AMS [List of AMS Sources]

You can modulate AMS 2's Intensity from another AMS source. This selects that source.

### Intensity [+/-48.00 semitones]

This controls the depth and direction of the Intensity Mod AMS, in semitones. The result is summed with the main AMS 2 Intensity to produce the final pitch modulation amount.

---

## ▼ 4-7: Page Menu Commands

The number before each command shows its ENTER + number-key shortcut. For more information on these shortcuts, see "ENTER + 0-9: shortcuts for menu commands" on page 147.

- 0: **Write Program.** For more information, see "Write Program" on page 147.
- 1: **Exclusive Solo.** For more information, see "Exclusive Solo" on page 147.

## 4-8: Pickups and Feedback

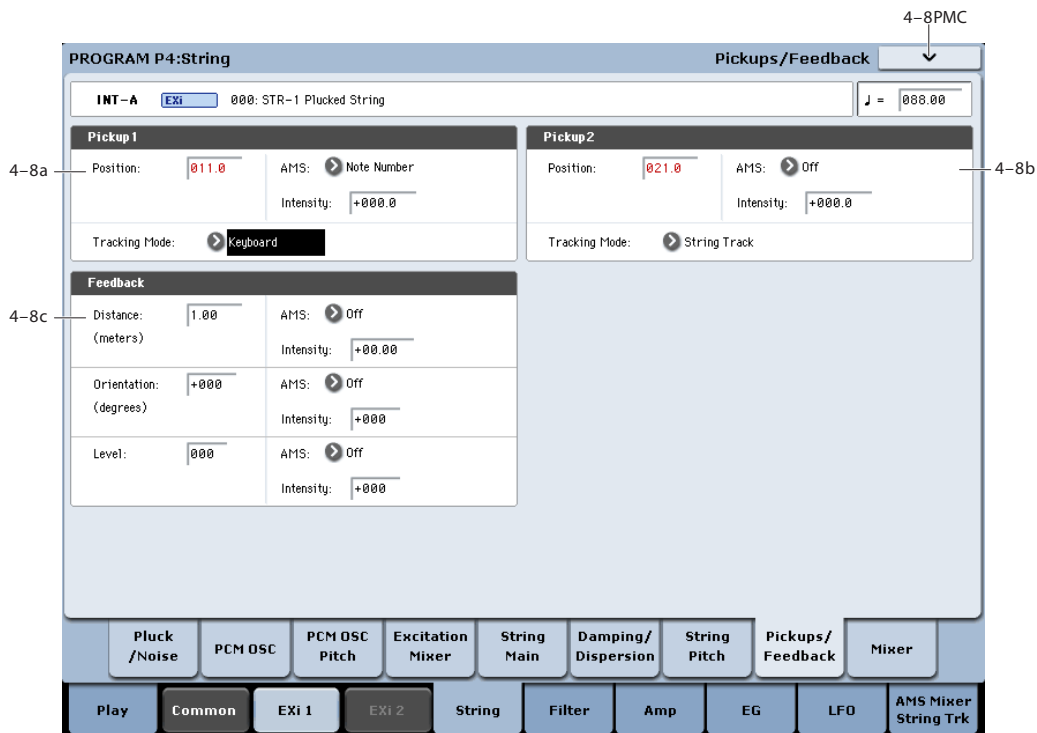

### 4-8a: Pickup 1

#### Position [0...100.0]

This adjusts the location of the pickup along the string. You can modulate this via AMS, to create effects similar to chorusing. Unlike the **Excitation Position**, you can modulate the **Pickup Position** while the note is sounding. Typically, values between 8.0 and 25.0 will work well.

The effect of the **Pickup Position** is similar to that of the **Excitation Position**. The comb filtering produced by the excitation and the two pickups is cumulative, and can produce complex patterns of peaks and valleys in the frequency response.

The position is approximately symmetric around 50 for all of the notes when **Tracking Mode** is set to **Keyboard**; in other words, a value of 60 is roughly the same as 40. When **Tracking Mode** is set to **String**, however, the point of symmetry varies for each note.

For more information, see “How Position affects the timbre” on page 261.

#### Harmonic and Pickup Positions

If the **Pickup Position** is same as the **Harmonic Position**, the pickup won’t produce much sound when **Harmonic Pressure** is applied.

#### Pickup Position and Note

The note being played defines another position along the string. For instance, with a guitar, the note is the position of the finger on the fretboard, as it presses down on the string. This creates a temporary end point for the string. At this end point, the string vibrates very little; beyond it, the string doesn’t vibrate at all.

Pickups don’t “hear” the entire string; they only hear the part of the string directly above them. If that part of the string isn’t vibrating (for instance, if it’s being held down!), there’s very little for a pickup to listen to—and thus the pickup won’t produce much sound, if it produces any at all.

For example, let’s say that you were listening only to **Pickup 1**.

Set the **Pickup Position** to 50 (the middle of the string),<sup>b</sup> and the **Tracking Mode** to **String Track**. The open note of the top string, E4, will sound fine. As you play higher notes, however, the sound will become thinner, until it becomes very quiet at E5.

What happened here?

The pickup stays in same location, right in the middle of the string. With each semitone, the point at which the string is being pressed down moves up one fret. When you reach an octave up (at E5), the string is being pressed down in the middle of the string, right over the pickup.

If you play even higher, the pickup produces no sound since it is now outside the part of the string that is vibrating.<sup>b</sup> (The STR-1 model assumes that your finger can hold down the string perfectly, so that no vibrations get past it.)

The higher the **Pickup Position**, the lower the range in which this can occur. The normal range of a guitar is much less than that of a 73- or 88-note keyboard, and higher pickup positions may make sense (and make sound!) only when playing within that normal guitar range.

Also, note that this can only happen when the **Tracking Mode** is set to **String Track**.



Pickup Position

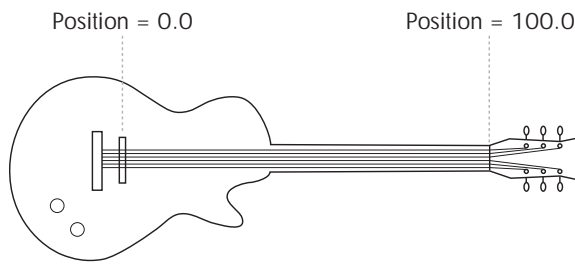

**AMS** [List of AMS Sources]

This selects a modulation source to control the **Position**. Try using an LFO, for instance. For a list of AMS sources, see “Alternate Modulation Source (AMS) List” on page 1091.

**Intensity** [-100.0...+100.0]

This controls the depth and direction of the **Position** AMS modulation.

**Tracking Mode** [String Track, Keyboard, Off]

This controls the relationship between the pickup **Position** and the pitch.

**String Track** scales the pickup position according to the current String, as set in the String Tracking section.

**Keyboard** scales the pickup position according to pitch, without taking the String settings into account. This might be more appropriate for clav sounds, for instance.

**Off** disables pitch-related scaling. This setting works well when sweeping the position via AMS (such as with an LFO) for chorusing effects, as described below.

**Creating “chorusing” with the pickups**

For a chorus-like effect, set the pickup **Tracking Mode** to **Off**, and modulate the pickup position with an LFO. With the pickup **Tracking Mode** set to **Keyboard**, the modulation depth varies with note, so that the depth is large on the low end of the keyboard and small at the top. With the pickup **Tracking Mode** set to **String**, the depth will step to a new value at each open string.

**4-8b: Pickup 2**

This is the second pickup. It has the same parameters as Pickup 1, above.

**4-8c: Feedback**

This lets you route audio from elsewhere in KRONOS through the string. You can use any of the audio inputs, any of the audio outputs, the REC buses, the FX Control buses, or the outputs of any of the Insert, Master, or Total Effects.

The main purpose of this is to process the STR-1 through one or more Insert Effects, such as an overdrive or amp model, and then send that audio back into the STR-1, for traditional electric guitar feedback effects.

All three feedback parameters—**Distance**, **Orientation**, and **Level**—can be modulated in real-time. You can use this to model the classic effect of holding an electric guitar near an amp until it feeds back, and then varying the pitch of the feedback by changing the guitar’s orientation in relation to, and distance from, the amp.

You can also route live or recorded audio through the string an/or filters, in realtime—and we’re sure that you’ll be able to think of other creative uses!

**Source and Channel**

The feedback source and channel (left, right, or L+R summation) are selected by the Input Source and Channel parameters in the current Program, Combination Timbre, or Song Track.

For more information, see “4-2: EXi Audio Input” on page 174 (Program mode), “2-6: EXi Audio Input” on page 461 (Combination mode), and “2-6: EXi Audio Input” on page 573 (Sequencer mode).

**Distance (meters)** [0.23...10.00]

This models the distance of the guitar from the amp. Usually, it’s best to set this very low, but higher settings may produce interesting effects.

**AMS** [List of AMS Sources]

This selects a modulation source to control the **Distance**. For a list of AMS sources, see “Alternate Modulation Source (AMS) List” on page 1091.

**Intensity** [-10.00...+10.00]

This controls the depth and direction of the **Distance** AMS modulation.

**Orientation (degrees)** [-180...+180]

This models turning the guitar away from the amp. Turning the guitar primarily affects the tone of the feedback, but also affects the pitch and the volume.

**AMS** [List of AMS Sources]

This selects a modulation source to control the **Orientation**. For a list of AMS sources, see “Alternate Modulation Source (AMS) List” on page 1091.

**Intensity** [-180...+180]

This controls the depth and direction of the **Orientation** AMS modulation.

**Level** [0...100]

This controls the overall gain of the feedback into the string. Unlike the other feedback parameters, this can be different for each voice.

**AMS** [List of AMS Sources]

This selects a modulation source to control the **Level**. For a list of AMS sources, see “Alternate Modulation Source (AMS) List” on page 1091.

**Intensity** [-100...+100]

This controls the depth and direction of the **Level** AMS modulation.

▼ 4–8: Page Menu Commands

The number before each command shows its ENTER + number-key shortcut. For more information on these shortcuts, see “ENTER + 0-9: shortcuts for menu commands” on page 147.

- 0: **Write Program**. For more information, see “Write Program” on page 147.
- 1: **Exclusive Solo**. For more information, see “Exclusive Solo” on page 147.

4-9: Mixer

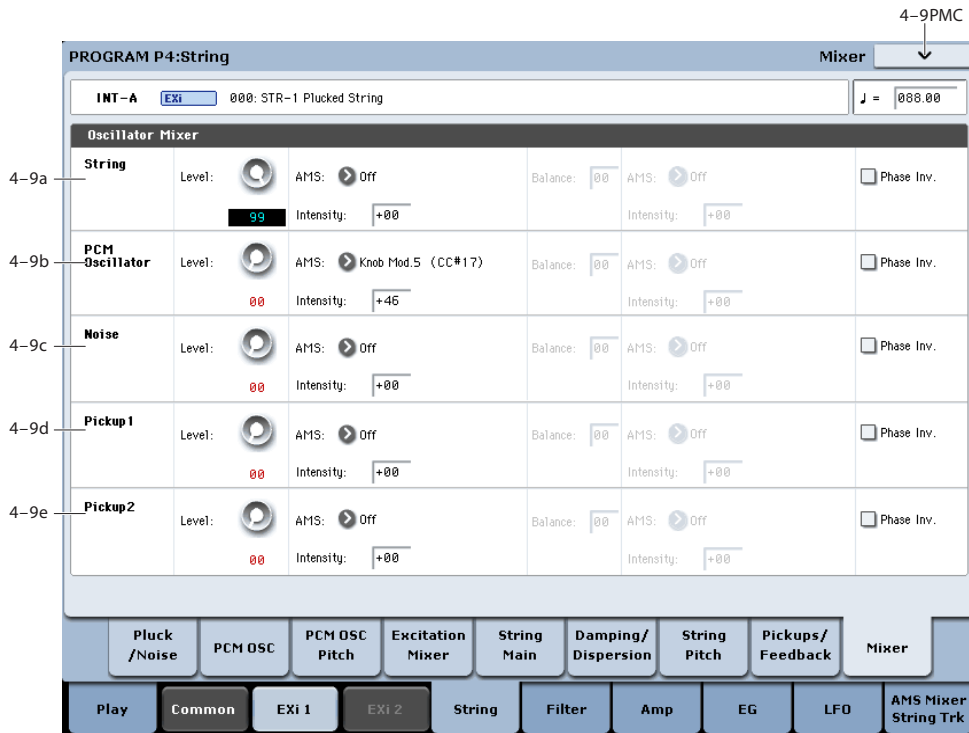

The Mixer page controls the volume levels and filter routing for the main String output, as well as the direct outputs (bypassing the string) of the PCM oscillator and Noise Generator. For instance, you can:

- Control the volume levels for the String, the PCM Oscillator, and the Noise Generator.
- Modulate these volume levels via AMS.
- When the **Filter Routing** is set to either **Serial** or **Parallel**, you can route each of the five elements through Filter A, Filter B, or a combination of the two—and then modulate that routing via AMS. For instance, you can create a layer by setting the **Filter Routing** to **Parallel**, and then sending the PCM Oscillator to Filter A, and the String to Filter B.

4-9a: String

**Level** [0...100]

This controls the volume level for the String.

**AMS** [List of AMS Sources]

This selects an AMS source to control the **String Level**. For a list of AMS sources, see “Alternate Modulation Source (AMS) List” on page 1091.

**Intensity** [-100...+100]

This controls the depth and direction of the **String Level** AMS modulation.

**Balance** [0...100]

This controls the filter routing for the String. It applies only when the **Filter Routing** is set to either **Serial** or **Parallel**; otherwise, it is grayed out.

0 is the default, and means that the String goes into Filter A. If the **Filter Routing** is set to **Serial**, it will also pass through Filter B.

99 means that the String goes into Filter B.

In between, the String will go to a combination of both filters. By modulating the **Balance** via AMS, you can crossfade between routing through Filter A and Filter B. For more information, see “Interaction between the filters and the mixer,” on page 274.

**AMS** [List of AMS Sources]

This selects an AMS source to control the **String Balance**. For a list of AMS sources, see “Alternate Modulation Source (AMS) List” on page 1091.

**Intensity** [-100...+100]

This controls the depth and direction of the **String Balance** AMS modulation.

**Phase Invert** [Off, On]

This inverts the phase of the String.

---

### 4-9b: PCM Oscillator

This controls the volume level and balance for the PCM Oscillator. It has the same parameters as described under “4-9a: String,” above.

---

### 4-9c: Noise

The Noise Generator has the same mixer parameters as described under “4-9a: String,” above.

---

### 4-9d: Pickup 1

Pickup 1 has the same mixer parameters as described under “4-9a: String,” above.

Try inverting the phase for one of the two pickups; this can produce an interesting effect.

---

### 4-9e: Pickup 2

Pickup 2 has the same mixer parameters as described under “4-9a: String,” above.

---

## ▼ 4-9: Page Menu Commands

The number before each command shows its ENTER + number-key shortcut. For more information on these shortcuts, see “ENTER + 0-9: shortcuts for menu commands” on page 147.

- **0: Write Program.** For more information, see “Write Program” on page 147.
- **1: Exclusive Solo.** For more information, see “Exclusive Solo” on page 147.

## Program P5: Filter

### 5-1: Filter Basic

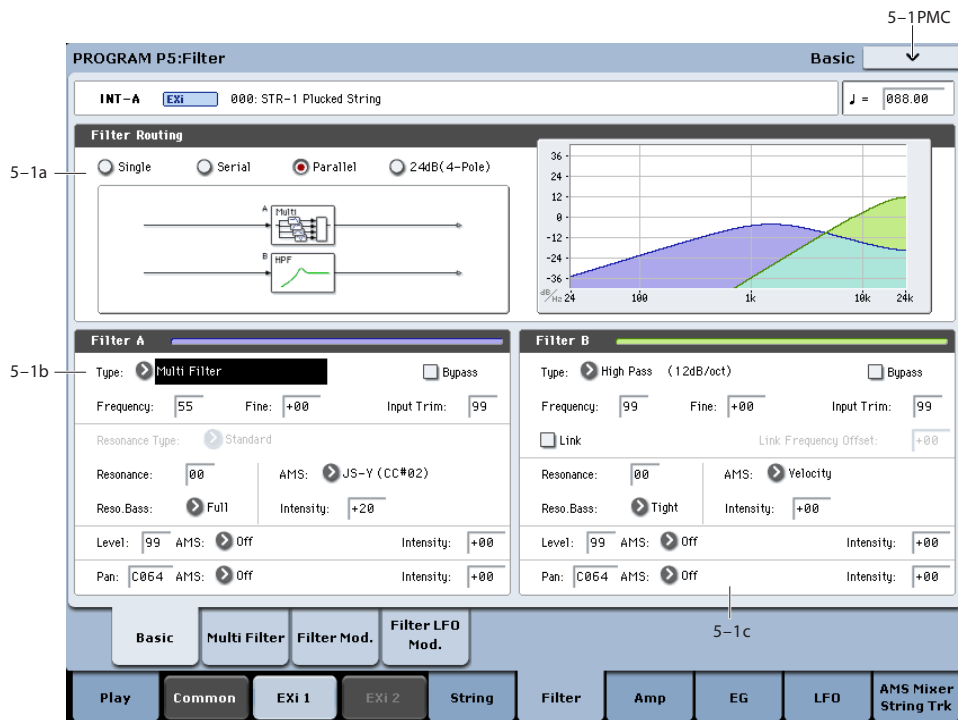

#### Interaction between the filters and the mixer

When the **Filter Routing** is set to either **Single** or **24dB/oct**, the routing from the String section into the Filter section is fairly simple. There's only a single filter, and that filter processes the entire sound.

Things can get more interesting when the **Filter Routing** is set to **Serial** or **Parallel**. In these modes, The Mixer page's **Balance** parameters let you separately control the filter routing for each of the five inputs: the String, the PCM Oscillator, the Noise Generator, Pickup1, and Pickup2.

When an input's **Balance** is set to **0**, it goes into Filter A. (Note that if the **Filter Routing** is set to **Serial**, the signal will also pass through Filter B.)

If the input's **Balance** is set to **99**, it goes directly into Filter B, regardless of whether the routing is set to **Serial** or **Parallel**.

#### Standard serial configuration

To create a standard serial filter configuration:

1. Set the **Filter Routing** to **Serial**.

This connects the output of Filter A to the input of Filter B.

2. Set all of the mixer's **Balance** controls to **0**.

This makes all of the inputs go to Filter A first, and then through Filter B.

#### Standard parallel configuration

To create a standard parallel filter configuration:

1. Set the **Filter Routing** to **Parallel**.

2. Set all of the mixer's **Balance** controls to **50**.

This routes all of the inputs to both filters, at equal volumes.

#### Dual signal paths

You can also send the String through Filter A, and the PCM Oscillator through Filter B (or vice-versa), to create a layered sound. For instance:

1. Set the **Filter Routing** to **Parallel**.

2. Set the **String's Balance** to **0**.

This routes the String to Filter A.

3. Set the **PCM Oscillator's Balance** to **99**.

This routes the PCM Oscillator to Filter B.

#### Anywhere in-between

If an input's **Balance** is set between **1** and **98**, it will go to a combination of both filters—so that many “in between” filter effects are available.

Finally, by modulating an input's **Balance** via AMS, you can crossfade between routing through Filter A and Filter B.

### 5-1a: Routing

#### Filter Routing [Single, Serial, Parallel, 24dB/oct]

There are two filters, Filter A and Filter B. This parameter controls whether one or both of the filters are used, and if both are used, it controls how they are connected to each other.

**Single.** This uses only Filter A as a single 2-pole, 12dB/octave filter (6dB for Band Pass and Band Reject). When this option is selected, the controls for Filter B will be grayed out.

**Serial.** This uses both filters. The output of Filter A is processed through Filter B.

**Parallel.** This also uses both Filter A and Filter B. Unlike Serial, above, the outputs of the two filters are kept separate, with individual control over both level and pan.

**24dB/oct.** This merges both filters to create a single 4-pole, 24dB/octave filter (12dB for Band Pass and Band Reject). In comparison to Single, this option produces a sharper roll-off beyond the cutoff frequency, as well as a slightly more delicate resonance. Many classic analog synths used this general type of filter.

When **24dB/oct** is selected, only the controls for Filter A are active; the controls for Filter B will be grayed out. Also, note that the **Multi Filter** is not available in this mode.

## 5-1b: Filter A

**Filter Type** [Low Pass, High Pass, Band Pass, Band Reject, Multi Filter]

The filter will produce very different results depending on the selected filter type. The selections will change slightly according to the selected **Filter Routing**, to show the correct cutoff slope in dB per octave.

**Low Pass.** This cuts out the parts of the sound which are **higher** than the cutoff frequency. Low Pass is the most common type of filter, and is used to make bright timbres sound darker.

**High Pass.** This cuts out the parts of the sound which are **lower** than the cutoff frequency. You can use this to make timbres sound thinner or more buzzy.

**Band Pass.** This cuts out all parts of the sound, both highs and lows, except for the region around the cutoff frequency. Since this filter cuts out both high and low frequencies, its effect can change dramatically depending on the cutoff setting and the oscillator's multisample.

With low resonance settings, you can use the Band Pass filter to create telephone or vintage phonograph sounds. With higher resonance settings, it can create buzzy or nasal timbres.

**Band Reject.** This filter type—also called a notch filter—cuts only the parts of the sound directly around the cutoff frequency. Try modulating the cutoff with an LFO to create phaser-like effects.

**Multi Filter.** This is a complex filter which is capable of all of the above filter types, and many more besides. For more information, see “5-2: Multi Filter,” on page 277.

The Multi Filter is available only for Filter A, and only when the Filter Routing is set to **Single**, **Serial** or **Parallel**.

### Filter Types and Cutoff Frequency

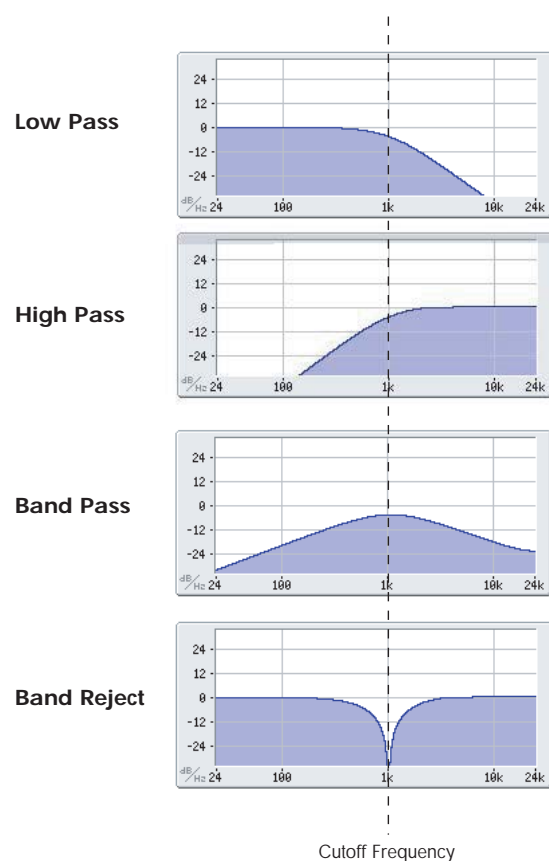

**Bypass** [Off, On]

This lets you bypass Filter A completely.

If **Bypass** is **Off**, Filter A functions normally.

When **Bypass** is **On**, Filter A has no effect on the input signal.

**Trim** [00...99]

This adjusts the volume level at the input to Filter A. If you notice that the sound is distorting, especially with high Resonance settings, you can turn the level down here, or at the Output Level.

Note that the filter will not clip internally, so there is no difference between adjusting the Input Trim and the Output Level. Either of these controls will allow you to minimize clipping later in the signal chain, such as may occur in some effects.

**Output Level** [00...99]

This controls the output level of Filter A. You can use this to balance the volumes of Filters A and B when the Routing is set to Parallel, or to turn down the volume to avoid clipping later in the signal chain.

**AMS** [AMS Sources]

This selects a modulation source to control the **Output Level**. For a list of AMS sources, see “Alternate Modulation Source (AMS) List” on page 1091.

**Intensity** [-99...+99]

This controls the depth and direction of the **Output Level** modulation.

**Frequency** [00...99]

This controls the cutoff frequency of Filter A, in increments of 1/10 of an octave. The specific effect of the cutoff frequency will change depending on the selected **Filter Type**, as described above.

**Frequency Fine** [-99...+99]

This provides fine control of the filter cutoff frequency. Each step of this parameter is equal to 1/100 of a step of the main **Frequency** parameter, above.

**Resonance Type** [Standard, High]

This controls the strength of the filter resonance when the **Filter Routing** is set to **24dB/oct**. When the routing is set to **Single**, **Serial**, or **Parallel**, this parameter is grayed out.

**Standard** provides the resonance character of a typical analog 4-pole filter.

**High** creates a more pronounced resonance.

**Resonance Bass** [Tight, Full]

This controls the character of the filter resonance at low cutoff frequencies. Its effect is most noticeable with high **Resonance** settings.

**Tight** produces a more restrained resonance, similar to a classic, American, wood-paneled monophonic synthesizer.

**Full** produces a wide, boomy resonance, reminiscent of a famous five-voice American synthesizer.

**Resonance** [00...99]

Resonance emphasizes the frequencies around the cutoff frequency.

When this is set to **0**, there is no emphasis, and frequencies beyond the cutoff will simply diminish smoothly.

At medium settings, the resonance will alter the timbre of the filter, making it sound more nasal, or more extreme.

At very high settings, the resonance can be heard as a separate, whistling pitch.

To make the resonance track the keyboard pitch, see “Key Follow,” on page 280.

**Resonance Mod by AMS** [AMS Sources]

This selects a modulation source to control the Resonance amount. For a list of AMS sources, see “Alternate Modulation Source (AMS) List” on page 1091.

**Intensity** [-99...+99]

This controls the depth and direction of the **Resonance** modulation.

**Pan** [Random, L001...C064...R127]

This controls the stereo pan for Filter A's output. It is available only when **Filter Routing** is set to **Parallel**.

When the **Filter Routing** is set to **Single**, **Serial**, or **24dB/oct**, the Pan parameters will be grayed out.

**AMS** [AMS Sources]

This selects an AMS source to modulate **Pan**. For a list of AMS sources, see “Alternate Modulation Source (AMS) List” on page 1091.

**Intensity** [-99...+99]

This controls the depth and direction of the **Pan** AMS modulation.

**5-1c: Filter B**

Filter B is available when the **Filter Routing** is set to **Serial** or **Parallel**. Otherwise, its parameters will be grayed out.

Filter B is almost the same as Filter A, but without the **Multi Filter** mode, and with the addition of the **Link** controls, as described below. For all other parameters, please see the descriptions under “5-1b: Filter A,” on page 275.

**Link** [Off, On]

When **Link** is **On**, most of Filter B's parameters are grayed out, and are instead controlled by the settings for Filter A.

Specifically, Filter B will use Filter A's settings for **Resonance**, **Resonance Bass**, and all Frequency and Resonance modulation settings. Filter B's **Frequency** is also linked to that of Filter A, with an optional frequency offset via the **Link Frequency Offset** parameter, below.

The **Bypass**, **Type**, **Input Trim**, **Output Level**, **Output Level AMS**, **Pan**, and **Pan AMS** parameters are still controlled separately.

**Link Frequency Offset** [-99...+99]

This offsets Filter B's Frequency from that of Filter A, and applies only when **Link** is **On**.

When **Link** is **Off**, this parameter is grayed out.

**▼ 5-1: Page Menu Commands**

The number before each command shows its ENTER + number-key shortcut. For more information on these shortcuts, see “ENTER + 0-9: shortcuts for menu commands” on page 147.

- **0: Write Program**. For more information, see “Write Program” on page 147.
- **1: Exclusive Solo**. For more information, see “Exclusive Solo” on page 147.

## 5-2: Multi Filter

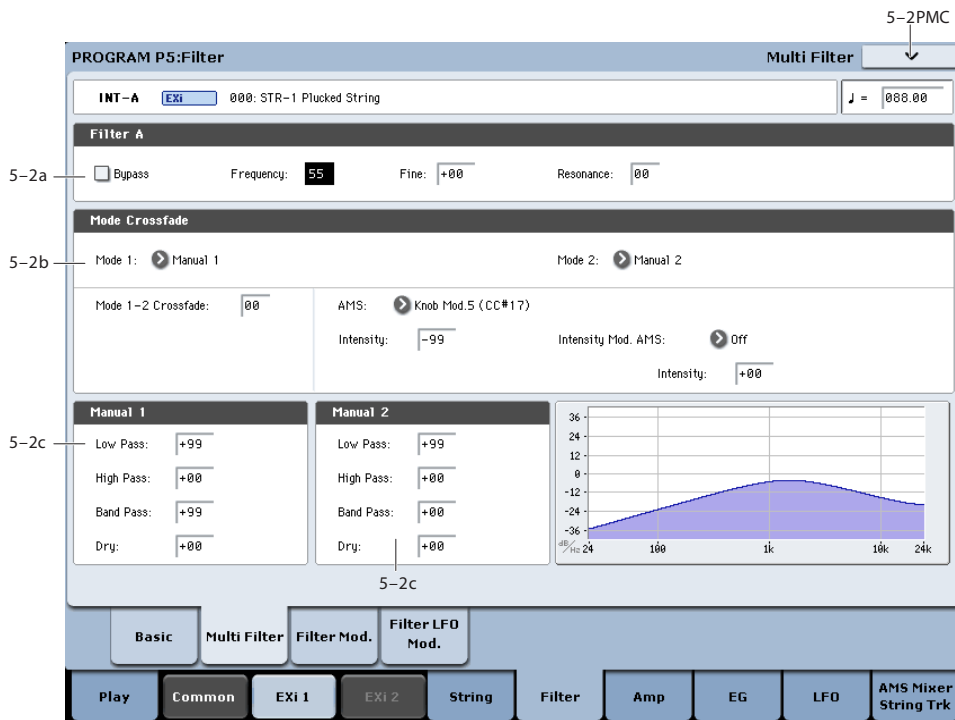

This page is available only when the **Filter A Type** is set to **Multi Filter**.

### What's a Multi Filter?

Standard multimode filters generate lowpass, highpass, and bandpass filters simultaneously - but only allow you to use one of them at a time.

The Multi Filter gives you access to all three filter modes simultaneously, in any combination, along with the dry input signal. You can choose from a large number of preset combinations, or create your own complex filter modes using the Manual controls.

This is capable of some cool sounds in and of itself, but things really get interesting when you use the Crossfade controls. These allow you to crossfade between two of these filter settings (Mode 1 and Mode 2), using AMS sources such as EGs, LFOs, or real-time controllers.

### 5-2a: Filter A

<b>Bypass</b>	[Off, On]
<b>Frequency</b>	[00...99]
<b>Fine</b>	[-99...+99]
<b>Resonance</b>	[00...99]

These are the same as the similarly-named parameters on the Filter Basic page, as described under "5-1b: Filter A" on page 275.

Edits to the values on this page will be reflected on the Filter Basic page, and vice-versa.

### 5-2b: Mode Crossfade

#### Mode 1 [List of filter types]

This sets the filter type for Mode 1.

**Low Pass, High Pass, Band Pass,** and **Band Reject** are the standard filter types. For more information, see "Filter Type," on page 275.

The following types combine two or more filters at equal volumes. **Dry** is the un-filtered input signal. The minus sign ("-") indicates when the phase of a filter is reversed: **LP+BP, LP-BP, LP-HP, BP+HP, BP-HP, Dry+LP, Dry-LP, Dry+BP, Dry-BP, Dry+LP-HP, Dry+LP-BP, Dry+BP-LP, Dry+BP-HP, Dry+HP-LP, Dry+HP-BP, LP+HP+BP.**

**All On** uses the Low Pass, High Pass, Band Pass, and Dry signals at equal volumes.

Manual 1 lets you create your own mix of the filters. For more information, see "5-2c: Manual 1," below.

#### Mode 2 [List of filter types]

Mode 2 has the same selections as Mode 1, except that the list ends with Manual 2 instead of Manual 1.

#### Mode 1-2 Crossfade [0...99]

This fades between the Mode 1 and Mode 2 settings.

0 is all **Mode 1**, 99 is all **Mode 2**, and 1-98 are intermediate values between the two Modes.

#### AMS [AMS Sources]

This selects a modulation source to control the **Mode 1-2 Crossfade**. For a list of AMS sources, see "Alternate Modulation Source (AMS) List" on page 1091.



**Intensity** [-99...+99]

This controls the depth and direction of the **Mode 1-2 Crossfade** modulation.

**Intensity Mod AMS** [List of AMS Sources]

This selects an AMS source to modulate the intensity of the main **Mode 1-2 Crossfade AMS**.

For instance, you can set **AMS** to use one of the LFOs, and then set the **Intensity Mod AMS** to JS -Y. You can then use the joystick to modulate the amount of the LFO.

**Intensity** [-99...+99]

This controls the depth and direction of the **Intensity Mod AMS**.

---

**5-2c: Manual 1**

These parameters let you create your own mix of the filters. When **Mode 1** is set to **Manual 1**, it will use these settings.

You may wonder why Band Reject is not included here. This is because it's not a filter mode per se. Instead, it's created by an equal combination of High Pass and Low Pass. Try it and see!

**Lowpass** [-99...+99]

This controls the volume of the Lowpass filter output. Negative values invert the phase.

**Highpass** [-99...+99]

This sets the volume of the Highpass filter output.

**Bandpass** [-99...+99]

This controls the volume of the Bandpass filter output.

**Dry** [-99...+99]

This sets the volume of the dry signal.

---

**5-2d: Manual 2**

The Manual 2 parameters are identical to those of Manual 1, as described above.

---

**▼ 5-2: Page Menu Commands**

The number before each command shows its ENTER + number-key shortcut. For more information on these shortcuts, see "ENTER + 0-9: shortcuts for menu commands" on page 147.

- 0: **Write Program**. For more information, see "Write Program" on page 147.
- 1: **Exclusive Solo**. For more information, see "Exclusive Solo" on page 147.

## 5-3: Filter Modulation

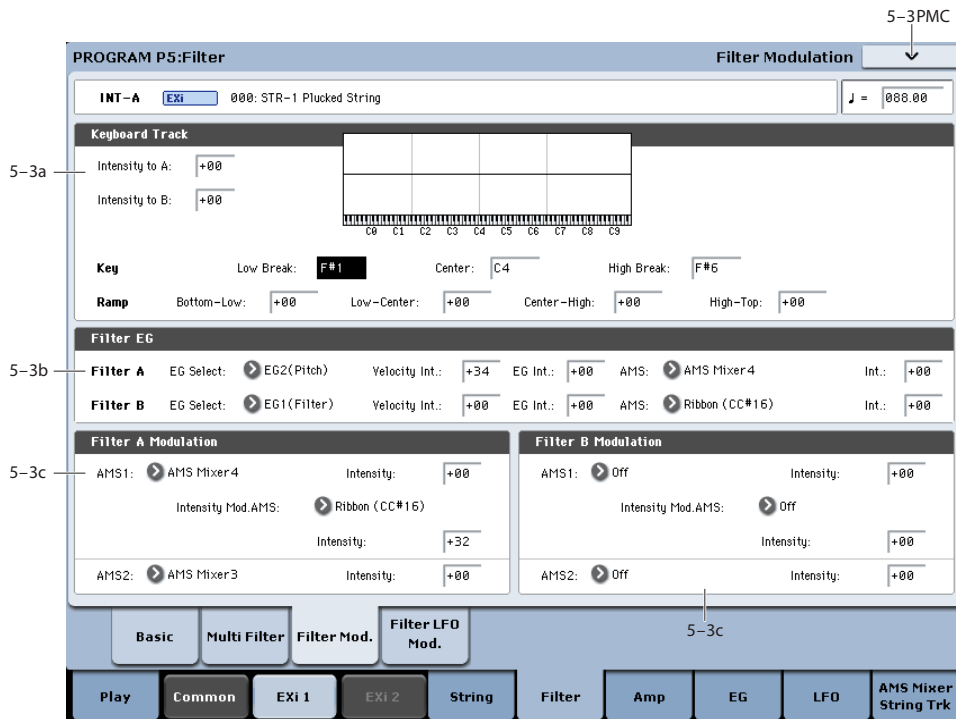

This page contains all of the settings for **Filter Frequency** modulation (except for the LFOs, which are on their own page). Among other things, you can:

- Set up complex keyboard tracking shapes, and control how the tracking affects filter cutoff.
- Control the effect of the Filter Envelope on filter cutoff.
- Assign AMS modulation for filter cutoff.

Filter B is available when the **Filter Routing** is set to **Serial** or **Parallel**. Otherwise, the parameters for Filter B will be grayed out.

### 5-3a: Keyboard Track AMSource

Most acoustic instruments get brighter as you play higher pitches. At its most basic, keyboard tracking recreates this effect by increasing the cutoff frequency of a lowpass filter as you play higher on the keyboard. Usually, some amount of key tracking is necessary in order to make the timbre consistent across the entire range.

The KRONOS keyboard tracking can also be much more complex, since it allows you to create different rates of change over up to four different parts of the keyboard.

The STR-1's Filter keyboard tracking parameters are identical to the HD-1's. For more detailed explanations of the parameters, please see "3-2a: Keyboard Track," on page 72.

There is one difference between the two, however: the STR-1's Filter tracking is affected by Portamento, so that it changes smoothly during glides.

### Intensity to A [-99...+99]

This controls how much the keyboard tracking will affect Filter A's cutoff frequency. The overall effect of the Keyboard Track is a combination of this **Intensity** value and the overall Keyboard Track shape.

### Intensity to B [-99...+99]

This controls how much the keyboard tracking will affect Filter B's cutoff frequency.

**Intensity to B** applies only when the **Filter Routing** is set to **Serial** or **Parallel**, and when **Link** is **Off**. In **Single** and **24dB/oct** modes, or if **Link** is **On**, this parameter is grayed out.

### Key

#### Low Break [C-1...G9]

This sets the breakpoint note between the two lower ramps.

#### Center [C-1...G9]

This sets the center of the keyboard tracking. At this key, the keyboard tracking has no effect on the filter frequency, or on any AMS destinations.

#### High Break [C-1...G9]

This sets the breakpoint note between the two higher ramps.

### Ramp

The effect on the filter cutoff is a combination of the ramp values, as set below, and the Intensity to A and B parameters. When Intensity is set to +99, a ramp of 50 changes the filter frequency by 1 octave for every

octave of the keyboard, and a ramp of +99 changes the frequency by 2 octaves for every octave of the keyboard.

+Inf and -Inf are special settings which create abrupt changes for split-like effects. When a ramp is set to +Inf or -Inf, the keyboard tracking will go to its extreme highest or lowest value over the span of a single key.

For more detailed explanations, please see “3–2a: Keyboard Track,” on page 72

**Bottom-Low** [-Inf, -99...+99, +Inf]

This sets the slope between the bottom of the MIDI note range and the Low Break key. For normal key track, use negative values.

**Low-Center** [-Inf, -99...+99, +Inf]

This sets the slope between the Low Break and Center keys. For normal key track, use negative values.

**Center-High** [-Inf, -99...+99, +Inf]

This sets the slope between the Center and High Break keys. For normal key track, use positive values.

**High-Top** [-Inf, -99...+99, +Inf]

This sets the slope between the High Break key and the top of the MIDI note range. For normal key track, use positive values.

**Key Follow**

To create the classic Key Follow effect, in which the filter frequency tracks the pitch of the keyboard:

1. Set the Filter Frequency to 30.
2. Set the Keyboard Track Intensity to +99.
3. Set the Bottom-Low and Low-Center ramps to -50.
4. Set the Center-High and High-Top ramps to +50.
5. Set the Center Key to C4.

The settings for the Low Break and High Break keys don't matter in this case.

---

**5-3b: Filter EG**

The EGs modulate the Filter A and B cutoff frequencies over time. You can control how strongly they will affect the filters in three different ways:

- Set an initial amount of EG modulation, using the EG Intensity parameters.
- Use velocity to scale the amount of the EG applied to the filter.
- Use any AMS source to scale the amount of the EG applied to the filter.

You can use all three of these at once, and the results are added together to produce the total EG effect.

To set up the EGs themselves, including attack and release times, levels, and so on, see “7-1: EG 1 (Filter),” on page 289.

**Filter A****EG Select** [EG 1 (Filter), EG 2 (Pitch), EG 3, EG 4, Amp EG]

This selects an EG to modulate Filter A's Frequency.

There are four assignable EGs, in addition to the Amp EG. Each of these can be used as a modulation source to control a wide variety of parameters.

In the midst of all this flexibility, we thought it would also be good to provide a little structure. With this in mind, EG 1 is named EG 1 (Filter) and EG 2 is labeled EG 2 (Pitch).

Please take these names as suggestions, rather than restrictions. If you like, you're free to use these EGs to control any EG or AMS destination, or to use other EGs to control Filter Frequency and Pitch.

**Velocity Intensity** [-99...+99]

This lets you use velocity to scale the amount of the EG applied to Filter A.

**EG Intensity** [-99...+99]

This controls the initial effect of the EG on Filter A's cutoff frequency, before any velocity or AMS modulation.

**AMS** [AMS Sources]

This selects an AMS modulation source to scale the amount of the EG applied to Filter A.

For a list of AMS sources, see “Alternate Modulation Source (AMS) List” on page 1091.

**Intensity** [-99...+99]

This controls the depth and direction of the AMS modulation.

**Filter B**

The EG parameters for Filter B are the same as those for “Filter A,” above.

When Link is On, or when the Filter Routing is set to Single or 24dB/oct, all of these parameters are grayed out.

---

**5-3c: Filter Modulation****Filter A Frequency****AMS 1** [AMS Sources]

This selects the first modulation source to control Filter A's Frequency. For a list of AMS sources, see “Alternate Modulation Source (AMS) List” on page 1091.

**Intensity** [-99...+99]

This controls the depth and direction of the Frequency modulation.

**Intensity Mod AMS** [List of AMS Sources]

This selects an AMS source to modulate the intensity of AMS 1.

**Intensity** [-99...+99]

This controls the depth and direction of the Intensity Mod AMS.

**AMS 2** [AMS Sources]

This selects a second modulation source to control Filter A's Frequency. For a list of AMS sources, see “Alternate Modulation Source (AMS) List” on page 1091.

**Intensity** [-99...+99]

This controls the depth and direction of AMS 2.

**Filter B Frequency**

The settings for Filter B are the same as those for “Filter A Frequency,” above.

When **Link** is **On**, or when the Filter Routing is set to **Single** or **24dB/oct**, all of these parameters are grayed out.

▼ **5-3: Page Menu Commands**

The number before each command shows its ENTER + number-key shortcut. For more information on these shortcuts, see “ENTER + 0-9: shortcuts for menu commands” on page 147.

- **0: Write Program.** For more information, see “Write Program” on page 147.
- **1: Exclusive Solo.** For more information, see “Exclusive Solo” on page 147.

**5-4: Filter LFO Mod**

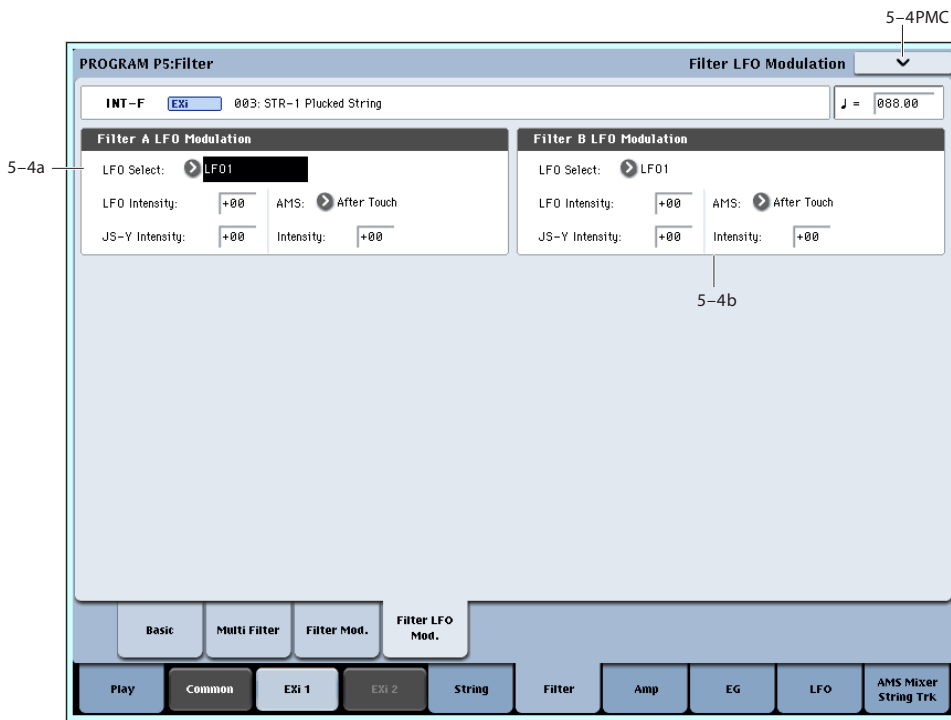

There are three LFO-to-Frequency controls for each filter: a basic amount (**LFO Intensity**), joystick -Y control of LFO amount (**JS- Y Intensity**), and AMS control of LFO amount (**AMS Intensity**). The three controls are summed together to determine the final LFO amount.

**5-4a: Filter A**

**LFO Select** [LFO 1, LFO 2, LFO 3, LFO 4, Common LFO]

This selects an LFO to modulate Filter A’s cutoff frequency.

The **LFO Intensity**, **JS -Y Intensity**, and **AMS** are all summed together to produce the final amount of LFO pitch modulation.

**LFO Intensity** [-99...+99]

This controls the initial effect of the LFO on Filter A’s cutoff frequency, before any JS+Y or AMS modulation.

**Negative (-)** settings will invert the phase of the LFO.

**JS -Y Intensity** [-99...+99]

Moving the joystick “down” from the center detent position, towards yourself, produces the JS -Y controller. You can use this to scale the amount of the LFO applied to Filter A.

This parameter sets the maximum amount of LFO modulation added by JS -Y.

**AMS** [AMS Sources]

This selects an AMS modulation source to scale the amount of the LFO applied to Filter A’s cutoff frequency.

For a list of AMS sources, see “Alternate Modulation Source (AMS) List” on page 1091.

**Intensity** [-99...+99]

This controls the depth and direction of the LFO AMS modulation.

---

### **5-4b: Filter B**

The settings for Filter B are the same as those for “5-4a: Filter A,” above.

When **Link** is **On**, or when the Filter Routing is set to **Single** or **24dB/oct**, all of these parameters are grayed out.

---

### **▼ 5-4: Page Menu Commands**

The number before each command shows its ENTER + number-key shortcut. For more information on these shortcuts, see “ENTER + 0-9: shortcuts for menu commands” on page 147.

- **0: Write Program.** For more information, see “Write Program” on page 147.
- **1: Exclusive Solo.** For more information, see “Exclusive Solo” on page 147.

## Program P6: Amp

These pages let you control the sound's volume (also called "amplitude," or "amp" for short), pan, and the dedicated amp envelopes and keyboard tracking generators. For instance, you can:

- Set the pan position and pan modulation.
- Control amp level and modulation, including keyboard tracking, the amp envelope, LFO modulation, and AMS control.

### 6-1: Amp

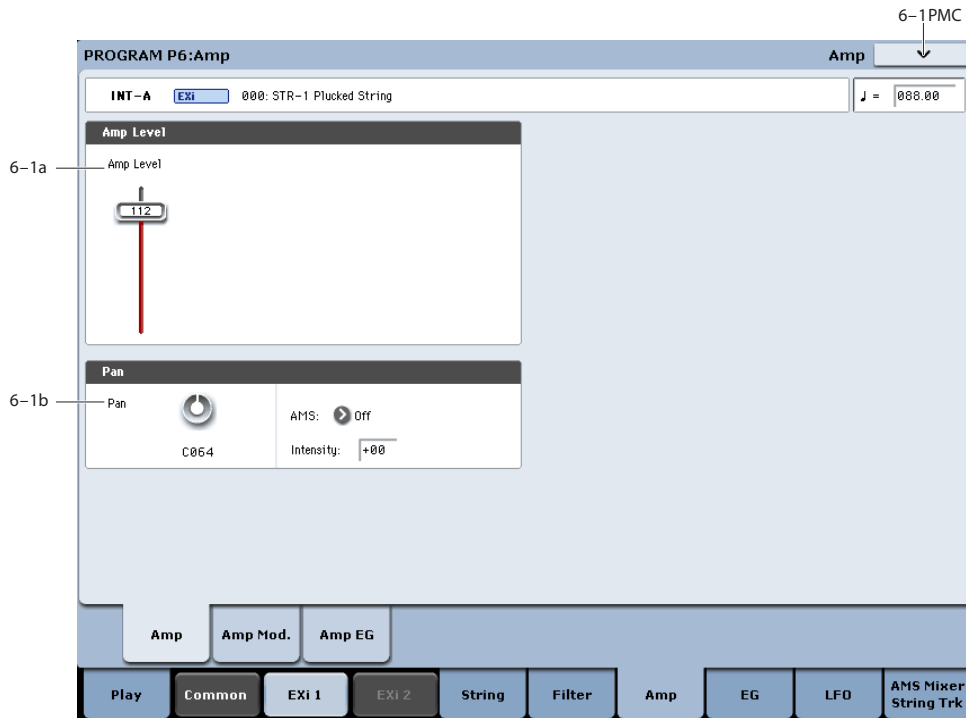

This page controls the basic settings for the Amp section. Here, you can:

- Set the initial volume level.
- Control the pan position and pan modulation.

#### 6-1a: Amp Level

##### Amp Level [0...127]

This controls the basic volume level of the STR-1, before keyboard tracking, velocity, and other modulation.

##### The Control Surface and volume

You can also control the volumes of EXi 1 and 2 directly from the Control Surface sliders. These volume levels are separate parameters, in addition to the individual EXi Amp Levels. To do so:

1. Press the Control Surface Timbre/Track button.
2. Move Slider 1 to set the volume for EXi 1, and Slider 2 for EXi 2.

##### MIDI and volume

**MIDI** You can control the Program's overall volume via MIDI using both Volume (CC#7) and Expression (CC#11). When used one at a time, the two controllers work in exactly the same way: a MIDI value of 127 is equal to the Amp Level setting, and lower values reduce the volume.

If both CC#7 and CC#11 are used simultaneously, the one with the *lower* value determines the maximum volume, and the one with the higher value scales down from that maximum.

#### 6-1b: Pan

##### Pan [Random, L001...C064...R127]

This controls the stereo pan of the EXi. A setting of **L001** places the sound at the far left, **C064** in the center, and **R127** to the far right.

When this is set to **Random**, the pan position will be different for each note-on.

You can also set this Pan parameter directly from the Control Surface knobs. To do so:

1. Press the Control Surface Timbre/Track button.
2. Set the MIXER KNOBS switch to INDIVIDUAL PAN.
3. Move Knob 1 to set the pan for EXi 1, and Knob 2 to set the pan for EXi 2.

**MIDI** You can also control pan via MIDI Pan (CC#10). A CC#10 value of 0 or 1 places the sound at the far left, 64 places the sound at the location specified by the "Pan" parameter, and 127 places the sound at the far right.

Note: you can select Random pan only from the on-screen UI, and not from MIDI or the Control surface.

**AMS**

[AMS Sources]

This selects an AMS source to modulate **Pan**. For a list of AMS sources, see “Alternate Modulation Source (AMS) List” on page 1091.

**Intensity**

[-99...+99]

This controls the depth and direction of the AMS modulation for **Pan**.

For example, if **Pan** is set to C064 and **AMS** is set to Note Number, **positive (+)** intensities will cause the sound to move toward the right as you play higher than C4, and toward the left as you play lower than C4.

Negative (-) intensities will have the opposite effect.

▼ **6-1: Page Menu Commands**

The number before each command shows its ENTER + number-key shortcut. For more information on these shortcuts, see “ENTER + 0-9: shortcuts for menu commands” on page 147.

- **0: Write Program.** For more information, see “Write Program” on page 147.
- **1: Exclusive Solo.** For more information, see “Exclusive Solo” on page 147.

**6-2: Amp Modulation**

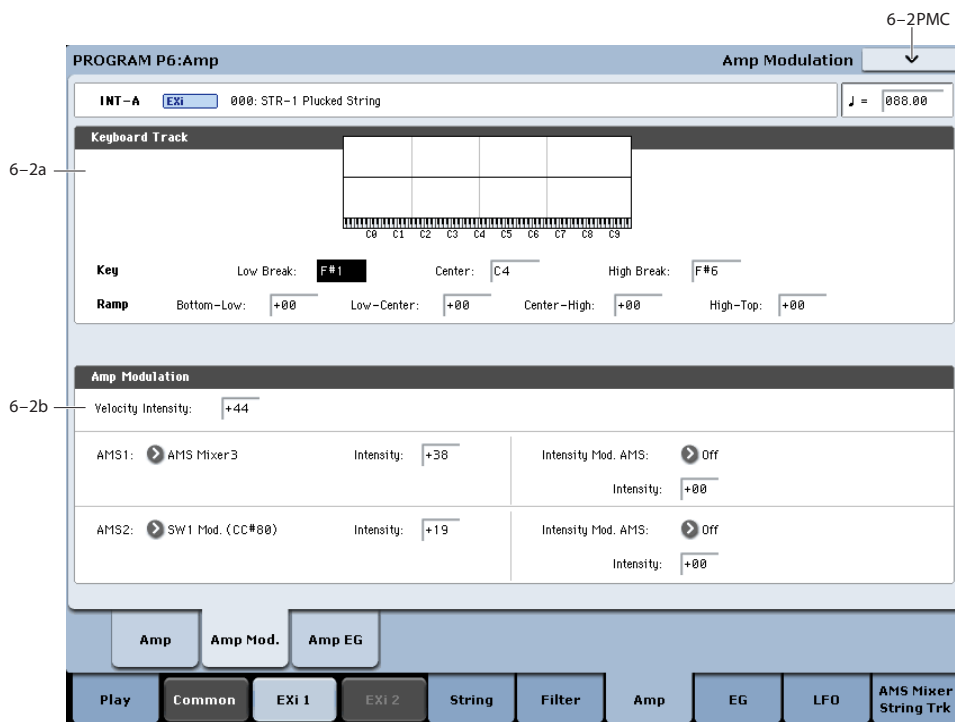

This page contains the settings for the STR-1’s Amp level modulation. Among other things, you can:

- Set up complex keyboard tracking shapes to control the Amp level.
- Assign AMS modulation for the Amp level.
- Control the effect of the LFOs on the Amp level.

The total effects of the modulation can increase the volume to a maximum of two times louder than the Amp Level setting.

**6-2a: Keyboard Track** AMSSource

Keyboard tracking lets you vary the volume as you play up and down the keyboard. Usually, some amount of key tracking is necessary in order to make the volume consistent across the entire range.

The STR-1’s Amp keyboard tracking parameters are identical to the HD-1’s. For more detailed explanations of the parameters, please see “4-2a: Keyboard Track,” on page 84.

There is one difference between the two, however: the STR-1’s Amp tracking is affected by Portamento, so that it changes smoothly during glides.

**Key**

**Low Break** [C-1...G9]

This sets the breakpoint note between the two lower ramps.

**Center** [C-1...G9]

This sets the center of the keyboard tracking. At this key, the keyboard tracking has no effect on the volume, or on any AMS destinations.

**High Break** [C-1...G9]

This sets the breakpoint note between the two higher ramps.



**Ramp**

**Bottom-Low** [-Inf, -99...+99, +Inf]

This sets the slope between the bottom of the MIDI note range and the Low Break key. For normal key track, use negative values.

Ramp	Change in level
-Inf	Silent in one half-step
-99	Silent in one whole-step
-95	Silent in one octave
-48	Silent in two octaves
-25	Silent in four octaves
00	no change
+25	x2 in four octaves
+50	x2 in two octaves
+99	x2 in one octave
+Inf	x2 in one half-step

**Low-Center** [-Inf, -99...+99, +Inf]

This sets the slope between the Low Break and Center keys. For normal key track, use negative values.

**Center-High** [-Inf, -99...+99, +Inf]

This sets the slope between the Center and High Break keys. For normal key track, use positive values.

**High-Top** [-Inf, -99...+99, +Inf]

This sets the slope between the High Break key and the top of the MIDI note range. For normal key track, use positive values.

**6-2b: Amp Modulation**

You can modulate the Amp level by velocity and two AMS sources. Each of the AMS sources also has its own secondary intensity modulation.

This modulation scales the basic Amp level and Amp EG level parameters. If these original levels are low, the maximum volume available with modulation will also be reduced.

Note that there is an upper limit to Amp modulation. Once the volume level reaches double the programmed Amp Level and Amp EG level settings, it cannot be increased any further.

**Velocity Intensity** [-99...+99]

With **positive (+)** values, the volume will increase as you play harder.

With **negative (-)** values, the volume will decrease as you play harder.

**AMS1** [AMS Sources]

This selects the first modulation source for the Amp level. For a list of AMS sources, see "Alternate Modulation Source (AMS) List" on page 1091.

**Intensity** [-99...+99]

This sets the initial amount of **AMS1**. The **Intensity Mod AMS** then adds to this initial amount.

**Intensity Mod AMS** [AMS Sources]

This selects a secondary AMS modulation source to scale the intensity of **AMS1**.

For a list of AMS sources, see "Alternate Modulation Source (AMS) List" on page 1091.

**Intensity** [-99...+99]

This controls the depth and direction of the **Intensity Mod AMS**. Even if the main **AMS1 Intensity** is set to 0, **Intensity Mod AMS** can still control the final amount of **AMS A** over the full +/-99 range.

For example, if **AMS1** is set to **LFO1**, and **Intensity Mod AMS** is set to **After Touch**, **positive** settings mean that aftertouch will increase the amount of **LFO** modulation.

**AMS2** [AMS Sources]

This selects a second modulation source for the Amp level. For a list of AMS sources, see "Alternate Modulation Source (AMS) List" on page 1091.

**Intensity** [-99...+99]

This sets the initial amount of **AMS2**. The **Intensity Mod AMS** then adds to this initial amount.

**Intensity Mod AMS** [AMS Sources]

This selects a secondary AMS modulation source to scale the intensity of **AMS2**.

For a list of AMS sources, see "Alternate Modulation Source (AMS) List" on page 1091.

**Intensity** [-99...+99]

This controls the depth and direction of the **Intensity Mod AMS**. Even if the main **AMS2 Intensity** is set to 0, **Intensity Mod AMS** can still control the final amount of **AMS A** over the full +/-99 range.

**AMS3** [AMS Sources]

This selects a third modulation source for the Amp level. For a list of AMS sources, see "Alternate Modulation Source (AMS) List" on page 1091.

**Intensity** [-99...+99]

This sets the initial amount of **AMS3**.

**▼ 6-2: Page Menu Commands**

The number before each command shows its ENTER + number-key shortcut. For more information on these shortcuts, see "ENTER + 0-9: shortcuts for menu commands" on page 147.

- 0: **Write Program**. For more information, see "Write Program" on page 147.
- 1: **Exclusive Solo**. For more information, see "Exclusive Solo" on page 147.

## 6-3: Amp EG AMSource

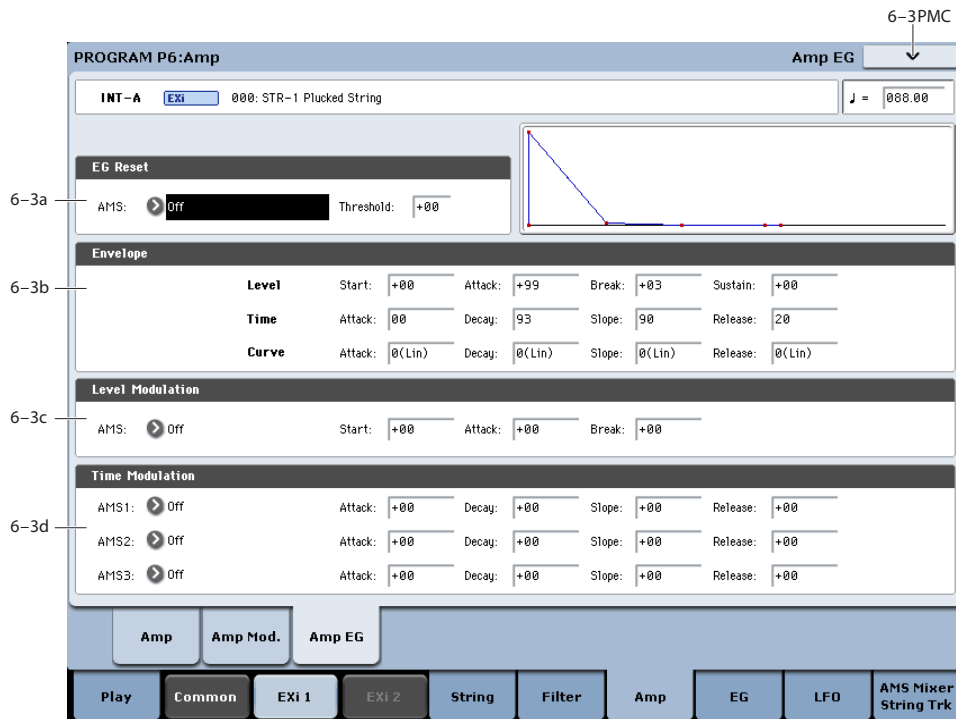

The STR-1's Amp EG is identical to the HD-1's. For more detailed explanations of the Amp EG features, please see "4-3: Amp1 EG," on page 87.

Other envelopes can be used as additional controls via AMS, if desired.

### 6-3a: EG Reset

#### AMS [AMS Sources]

This selects an AMS source to reset the EG to the start point. For instance, you can use a tempo-synced LFO to trigger the EG in a repeating rhythm. This reset is in addition to the initial note-on, which always causes the EG to start.

Note: Once the Amp EG is in its Release segment, it cannot be reset. (Otherwise, the sound might keep playing forever!)

For a list of AMS sources, see "Alternate Modulation Source (AMS) List" on page 1091.

#### Threshold [-99...+99]

This sets the AMS level which will trigger the EG reset. Among other things, you can use this to adjust the exact point in an LFO's phase at which the EG will be reset, effectively controlling its "groove" against other rhythmic effects.

When the threshold is **positive**, the EG triggers when passing through the threshold moving upwards. When the threshold is **negative**, the EG triggers when passing through the threshold moving downwards.

**Note:** with some LFO shapes, and with faster LFO speeds, the LFO may not always reach the extreme values of +99 or -99. In this case, setting the **Threshold** to these values may cause inconsistent behavior, or

may mean that the EG doesn't reset at all. If this happens, reduce the **Threshold** until the EG triggers consistently.

### 6-3b: Amp EG

These parameters specify how the amp EG will change over time.

*Amp EG*

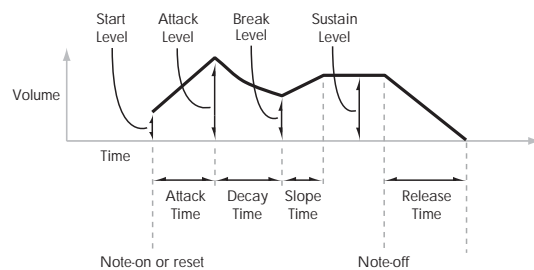

#### Level

##### Start [00...99]

This sets the initial volume level at note-on.

##### Attack [00...99]

This sets the level at the end of the Attack time.

##### Break [00...99]

Break, short for Break Point, sets the level at the end of the Decay time.

##### Sustain [00...99]

This sets the level at the end of the Slope time. Once it reaches the Sustain level, the EG will stay there until note-off (unless it is reset via AMS).

### Time

Higher values mean longer times. For a chart showing equivalents in milliseconds, please see “Time” on page 88.

#### Attack [00...99]

This sets how long the EG takes to move from the Start level to the Attack level.

The minimum attack time is 2/3 of a millisecond—as fast as the most punchy of classic analog synths.

For the fastest possible attack time, you can set the Start level to +99; in this case, the EG will start instantaneously at its maximum value.

#### Decay [00...99]

This sets the time it takes to move from the Attack level to the Break level.

#### Slope [00...99]

This sets how long the EG takes to move from the Break level to the Sustain level. Once it reaches the Sustain level, the EG will stay there until note-off (unless it is reset via AMS).

#### Release [00...99]

This sets how long it takes the EG to move from the Sustain level to silence.

### Curve

Classic analog synth envelopes created curved shapes naturally. The KRONOS goes a step further than vintage synths, however, and lets you control the amount of curvature separately for each of the four envelope segments.

When you change the curvature, the EG times remain the same. However, greater curvature will tend to *sound* faster, because the value changes more quickly at the beginning.

You may find that different amounts of curvature are suitable for segments which go up and segments which go down.

For instance, a curve of 3 is a good default setting for upward segments, such as Attack. On the other hand, a curve of 6 or more is good for downward segments, such as Decay and Release.

#### Attack [0 (Linear), 1...9, 10 (Exp/Log)]

This sets the curvature of the Attack segment - the transition from the Start level to the Attack level.

#### Decay [0 (Linear), 1...9, 10 (Exp/Log)]

This sets the curvature of the Decay segment - the transition from the Attack level to the Break level.

#### Slope [0 (Linear), 1...9, 10 (Exp/Log)]

This sets the curvature of the Slope segment - the transition from the Break level to the Sustain level.

#### Release [0 (Linear), 1...9, 10 (Exp/Log)]

This sets the curvature of the Release segment - the transition from the Sustain level to the Release level.

## 6-3c: Level Modulation

These settings let you use an AMS source to control the Level parameters of the EG. The Start, Attack, and Break levels share a single AMS source, but can each have different modulation intensities.

Note: Once the EG has started a segment between two points, that segment can no longer be modulated. For instance, if the EG is in the middle of the Decay time, you can no longer modulate either the Decay time or the Break level.

This also means that modulating the Start level, Attack level, or Attack time will not affect notes that are already sounding, unless the EG is then reset via AMS.

#### AMS [AMS Sources]

This selects an AMS source to control the EG’s Level parameters.

For a list of AMS sources, see “Alternate Modulation Source (AMS) List” on page 1091.

#### Start [-99...+99]

This controls the depth and direction of the AMS modulation for the Start level.

#### Attack [-99...+99]

This controls the depth and direction of the AMS modulation for the Attack level.

#### Break [-99...+99]

This controls the depth and direction of the AMS modulation for the Break level.

## 6-3d: Time Modulation

These settings let you use three different AMS sources to control the Time parameters of the EG. For each of the three AMS sources, the Attack, Decay, Slope, and Release times each have their own modulation intensities.

#### AMS1 [AMS Sources]

Selects the first AMS source to control the EG’s Time parameters. Velocity and Keyboard Track can both be useful here, for instance.

For a list of AMS sources, see “Alternate Modulation Source (AMS) List” on page 1091.

#### Attack [-99...+99]

This controls the depth and direction of the AMS modulation for the Attack time.

When the AMS source is at its maximum value—for instance, when Velocity is at 127—a setting of +8 will make the segment time almost twice as long, and a setting of -8 will cut the segment time almost in half.

#### Decay [-99...+99]

This controls the depth and direction of the AMS modulation for the Decay time.

#### Slope [-99...+99]

This controls the depth and direction of the AMS modulation for the Slope time.

**Release** **[-99...+99]**

This controls the depth and direction of the AMS modulation for the Release time.

**AMS2 and AMS3**

These select the second and third AMS sources, respectively, for controlling the EG's Time parameters. Each has its own intensities for Attack, Decay, Slope, and Release. The parameters of both AMS2 and AMS 3 are identical to those of AMS1, above.

---

**▼ 6-3: Page Menu Commands**

The number before each command shows its ENTER + number-key shortcut. For more information on these shortcuts, see "ENTER + 0-9: shortcuts for menu commands" on page 147.

- **0: Write Program.** For more information, see "Write Program" on page 147.
- **1: Exclusive Solo.** For more information, see "Exclusive Solo" on page 147.
- **2: Copy Envelope.** For more information, see "Copy Envelope" on page 224.
- **3: Swap Envelope.** For more information, see "Swap Envelope" on page 224.

## Program P7: EG 1-4

The STR-1 has four assignable EGs, in addition to the Amp EG. Each of these can be used as an AMS modulation source to control a wide variety of parameters.

There are also two parameters with dedicated EG modulation inputs: Frequency for Filters A and B. Any of the four EGs can be used for these modulation routings.

In the midst of all this flexibility, we thought it would also be good to provide a little structure. With this in mind, EG 1 is named EG 1 (Filter), and EG2 is named EG 2 (Pitch).

Please take these names as suggestions, rather than restrictions. If you like, you're free to use these envelopes to control any EG or AMS destination, or to use other EGs to control Filter Frequency or Pitch.

---

### 7-1: EG 1 (Filter) AMSource

---

### 7-2: EG 2 (Pitch) AMSource

---

### 7-3: EG 3 AMSource

---

### 7-4: EG 4 AMSource

The STR-1's EGs 1-4 are identical to the AL-1's EG1. For detailed explanations, please see "7-1: EG 1 (Filter)," on page 211.

---

## Program P8: LFO 1-4

The STR-1 has four assignable LFOs, in addition to the EXi Program's Common LFO. Each of these can be used as an AMS modulation source to control a wide variety of parameters.

---

### 8-1: LFO 1 AMSource

---

### 8-2: LFO 2 AMSource

---

### 8-3: LFO 3 AMSource

---

### 8-4: LFO 4 AMSource

The STR-1's LFOs 1-4 are identical to those of the AL-1. For detailed explanations, please see "8-2: LFO 1," on page 217.

## Program P9: AMS Mixers and String Track

### AMS Mixers

The AMS Mixers combine two AMS sources into one, or process an AMS source to make it into something new.

For instance, they can add two AMS sources together, or use one AMS source to scale the amount of another. You can also use them to modify the response of realtime controllers.

The AMS Mixer outputs appear in the list of AMS sources, just like other controllers.

This also means that the original, unmodified inputs to the AMS Mixers are still available as well. For instance, if you use Aftertouch as an input to a AMS Mixer, you

can use the processed version of the Aftertouch to control one AMS destination, and the original version to control another.

Finally, you can cascade the AMS Mixers together—for instance, you can use AMS Mixer 1 as an input to AMS Mixer 2.

### String Track

The **String Track** tracking generators allow you to scale parameters based on the string on which the note is played. This helps to model the sonic characteristics of the different strings, such as different materials (as with the nylon and steel strings of an acoustic guitar), different gauges of strings, and so on.

## 9-1: AMS Mixers 1-2 AMSource

## 9-2: AMS Mixers 3-4 AMSource

The STR-1's AMS Mixers are identical to those of the AL-1 (although the STR-1 has four, to the AL-1's two). For detailed explanations, please see "9-1: AMS Mixer," on page 221.

## 9-9: String Track AMSource

Multi-stringed instruments, such as guitars, often include strings of different thicknesses, or strings created using different techniques or materials. For instance, strings may be:

- Round-wound, flat-wound, or un-wound
- Steel, brass, copper, or nylon
- Thicker (heavy-gauge) or thinner (light-gauge)

For instance, electric guitars may use wound low strings along with un-wound high strings. Similarly, classical guitars generally use nylon treble strings along with wound-metal bass strings.

This means that some strings may sound very distinct from others, quite aside from the differences in pitch. It's almost as if each string was a sub-instrument of its own.

In order to physically model these differences, it's sometimes helpful to modulate certain parameters separately for each string, such as **Damping**, **Decay**, **Dispersion**, **Inharmonicity**, etc.

String Track lets you do exactly this. It's a variation of keyboard tracking, which divides the keyboard into 6 zones, corresponding to 6 strings. You can then set four different offsets for each string: one each for **Damping** and **Dispersion**, and then the two general-purpose **String Track 1** and **2**. All four can be used as AMS sources throughout the STR-1.

**Fret Number AMS Source**

Strings may also change in timbre as you move up the neck, playing higher and higher notes. To model this, you can use an additional AMS source, **Fret Number**.

**Fret Number** provides the distance up the neck for the current note. When the note is an "open string," **Fret Number's** value is zero. As notes move up the fretboard, **Fret Number** increases. Once the next "open string" is reached, **Fret Number** goes back to zero, and starts over again.

**9-9a: Fret Position** AMSource

**Fret Position** **[Open, 1...48]**

This controls the position at which the notes are played along the neck. This can have a significant effect on the timbre, since it may change the string on which a note is played.

To do this, **Fret Position** shifts the relationship between notes played on the keyboard (or via MIDI) and the selected String pitches. This changes the break-points for all of the String Track generators at once.

This means that as the **Fret Position** increases, the same note will be played in higher positions on the neck, using lower strings.

The current fret position (in other words, the combination of **Fret Position** and its AMS) is itself available as the AMS source named, appropriately, **Fret Position**.

**AMS** **[List of AMS Sources]**

This selects a modulation source to control the **Fret Position**. For a list of AMS sources, see "Alternate Modulation Source (AMS) List" on page 1091.

**Intensity** **[-48...+48]**

This controls the depth and direction of the **Fret Position** AMS modulation.

**9-9b: Strings**

**Strings 1-6** **[C-1...G9]**

These six parameters set the pitches of the strings, from the lowest pitch (String 1) to the highest pitch (String 6). These define keyboard zones, as shown below.

The same String settings are used for all String Track generators, including those for Damping and Dispersion. They are also used for the Excitation, Harmonic, and Pickup positions when their **Tracking Mode** parameters are set to **String Track**.

For more information, see "4-5a: Excitation" on page 261, "4-5b: Harmonic" on page 263, "4-6a: Damping" on page 265, "4-6b: Dispersion" on page 266, "4-8a: Pickup 1" on page 270, and "4-8b: Pickup 2" on page 271.

*String Track - strings and zones*

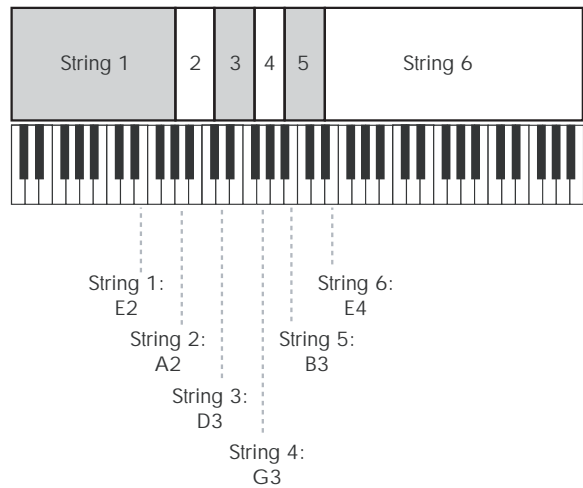

**9-9c: String Track 1** AMSource

**(Strings) 1...6** **[-100.0...+100.0]**

These set individual offsets for the six Strings. You can use these to modulate any AMS destination; they appear in the AMS list as String Track 1.

**9-9d: String Track 2** AMSource

This is a second set of individual String offsets, which appear in the AMS list as String Track 2. The parameters are identical to those of "9-9c: String Track 1," above.



## STR-1: Tone Adjust

STR-1 Tone Adjust Default Settings

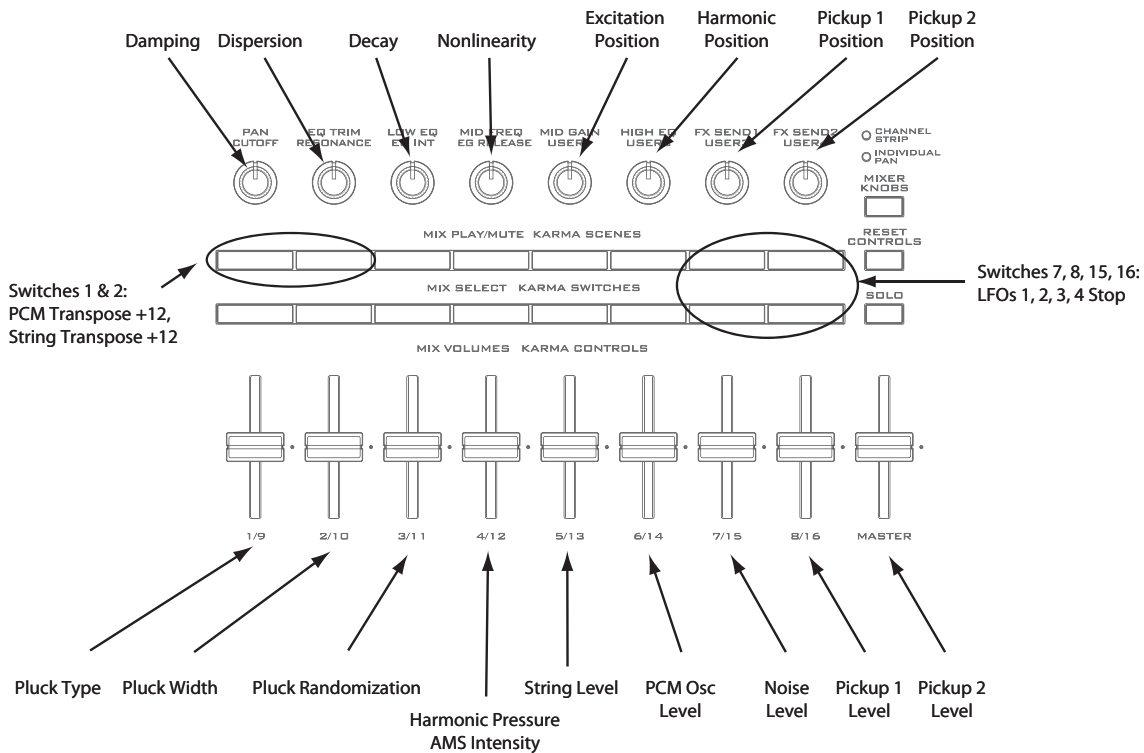

Tone Adjust provides an elegant physical interface to the STR-1's parameters. Most of the factory sounds use the default layout, as shown above. You can also customize the layout for individual sounds, if desired.

For more information about Tone Adjust, please see "0-9f: Tone Adjust," on page 30.

### STR-1 Tone Adjust parameters

The STR-1 supports all of the Common Tone Adjust parameters, as described under "0-9f: Tone Adjust," on page 30. It also adds a number of its own additional parameters, which apply only to the STR-1.

Note that these additional parameters are separate for each EXi, as opposed to being shared by both EXi in the Program.

All of the additional parameters are listed below. Tone Adjust parameters may affect the internal parameters in one of two ways: they may be **Relative**, in which case they scale the existing parameter value, or **Absolute**, in which case they over-write the existing value. Unless otherwise noted, all of the STR-1 parameters are **Absolute**.

The full name of the currently selected parameter is shown in the status line at the top of the Control Surface page, as well as in the popup menu. Some parameters with longer names may show an abbreviation for the slider, knob, and switch labels.

#### Pluck

- Pluck Type
- Pluck Randomization
- Pluck Delay

- Pluck Width
- Pluck Width AMS1 Intensity

#### Noise

- Noise Saturation
- Noise Filter Frequency

#### PCM Oscillator

- PCM Osc MS Select (PROG/0...16383)
- PCM Osc MS Bank (MS: ROM Mono...EXs7 Mono)
- PCM Osc MS Min # (meta)
- PCM Osc MS Max # (meta)
- PCM Osc Start Offset
- PCM Osc Reverse

#### PCM Pitch

- PCM Tune (-1200...+1200, relative)
- PCM Transpose (-12...+12, relative)
- PCM Pitch Slope
- PCM Pitch LFO AMS Intensity

#### Excitation Mixer

- Excitation PCM Oscillator level
- Excitation Pluck Level
- Excitation Noise Level

#### Excitation Filter

- Excitation Filter Type
- Excitation Filter Frequency
- Excitation Filter Resonance

**String**

- Excitation Position
- Harmonic Position
- Harmonic Pressure AMS1 Intensity
- Decay
- Nonlinearity
- Damping
- Dispersion

**String Pitch**

- String Tune (-1200...+1200, relative)
- String Transpose (-12...+12, relative)
- String Pitch Slope
- String Pitch LFO AMS Intensity

**Pickups**

- Pickup 1 Position
- Pickup 2 Position

**Feedback**

- Feedback Level AMS Intensity
- Feedback Distance AMS Intensity
- Feedback Orientation AMS Intensity

**Mixer**

- String Level
- PCM Oscillator Level
- Noise Level
- Pickup 1 Level
- Pickup 2 Level

**Filter A**

In addition to the standard Tone Adjust filter parameters, the STR-1 adds the following:

- Filter A Type
- Filter A Cutoff
- Filter A Resonance
- Filter A EG Intensity
- Filter A LFO Intensity

**Filter B**

Filter B has the same Tone Adjust parameters as Filter A, above.

**Amp**

- Amp AMS 1 Intensity
- Amp AMS 2 Intensity

**EGs**

In addition to supporting the standard Tone Adjust EG parameters, the STR-1 adds the following separate controls for both EG3 and EG4:

- Attack time (relative)
- Decay & Slope time (relative)
- Sustain level (relative)
- Release time (relative)

**LFOs**

In addition to supporting the standard Tone Adjust LFO parameters, the STR-1 adds the following separate controls:

- LFO 1, 2, 3, and 4 Waveform
- LFO 1, 2, 3, and 4 Shape
- LFO 3 Speed (relative)
- LFO 3 Fade (relative)
- LFO 3 Delay (relative)
- LFO 3 Stop
- LFO 4 Speed (relative)
- LFO 4 Fade (relative)
- LFO 4 Delay (relative)
- LFO 4 Stop



# EXi: MS-20EX

## MS-20EX Overview

The MS-20EX is a flexible, semi-modular virtual analog synthesizer. At its heart is a faithful re-creation of the original Korg MS-20, including both its features and its distinctive, often aggressive timbral signature.

To this core, we added features first introduced in the Korg Legacy MS-20 plug-in. Then, we added significant patch-panel modifications inspired by the MS-20's big brother, the MS-50, plus many other KRONOS-only enhancements. Features include:

- Korg's proprietary CMT (Component Modeling Technology)
- Up to 40-voice polyphony
- Two oscillators (including ring modulation), noise generator, and resonant, self-oscillating highpass and lowpass filters
- Many modifications to the Patch Panel, including separate access to VCOs 1 & 2, LPF, HPF, BPF, and VCA
- Two new patchable 2-in, 1-out audio-rate mixers, for combining and scaling audio and control signals
- Original MS-20 HADSR and DAR envelopes, plus four additional multi-stage EGs

- Original MS-20 MG and sample-and-hold, plus four additional LFOs
- AMS modulation of all original MS-20 parameters, along with four AMS Mixers
- Live audio input
- External Signal Processor, with dedicated filters, triggering, and audio-to-CV conversion
- Access to all standard EXi Program features, including the Common LFO, Common Step Sequencer, Key Track 1 & 2, KARMA, EQ, and effects—as well as layering with any other EXi (including using two MS-20EXs together!)

### MS-20EX uses EXi fixed resources

The MS-20EX takes up a very small amount of processing power, even if you're not playing any notes on the keyboard. This amount is around 1/12 that of the CX-3, but if other EXi are using large amounts of fixed resources, the number of MS-20EX that you can load may be limited. Each EXi in each Program counts towards the maximum; for instance, a Program with two MS-20EX's counts as two, not as one.

For more information, see "CX-3 & other EXi: Limitations on EXi fixed resources" on page 420.

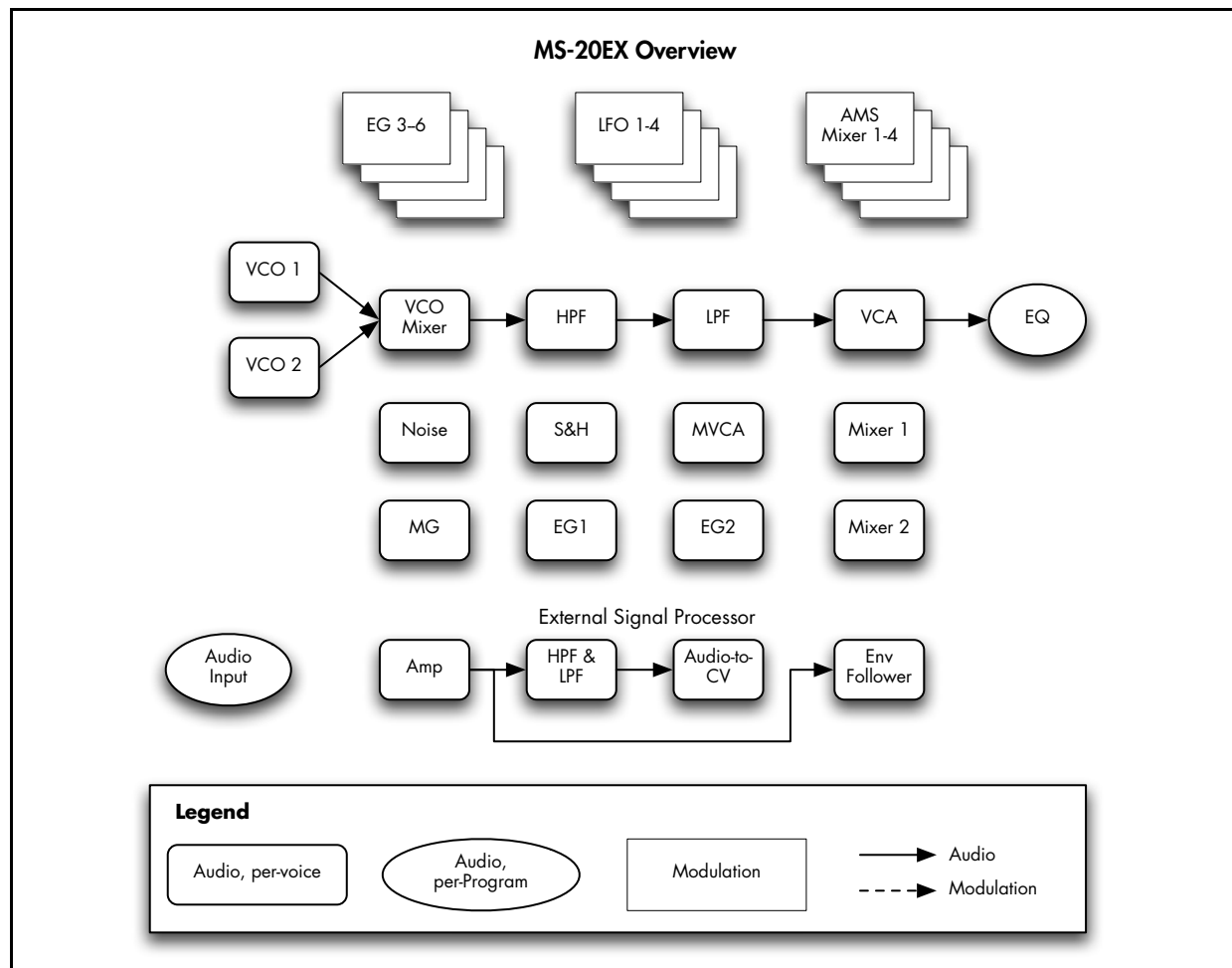

## Unsupported EXi Common parameters

The MS-20EX supports all of the EXi Common parameters, except for two of the voice allocation options: **Poly Legato** and **Mono Mode** (Normal/Use Legato Offset).

All of the other voice allocation options are fully supported, including Mono, Mono Legato, Unison, etc.

## On-screen knobs and switches and the Parameter Details area

### Parameter Details

The LCD displays include graphic knobs for all of the main MS-20EX parameters. These let you view and edit parameters quickly and easily.

You can program any original MS-20 sound using only these knobs. If you want more flexibility and control, however, the MS-20EX offers four additional EGs and LFOs, four AMS mixers, access to the EXi Program's Common LFO, Common Step Sequencer, and Vector features, and AMS modulation for almost every original MS-20 parameter.

The entryway to these advanced features is the Parameter Details area, located in the lower right-hand part of the screen. This shows information for the selected knob or switch, including its parameter group and parameter name, its exact value, and its AMS assignments:

*Parameter Details area*



### Editing on/off switches

To edit an on/off switch, such as the MG KEY SYNC button, simply:

1. Touch the switch to toggle the value.

### Assigning AMS modulation

Most parameters support modulation via AMS. Sources and intensities can be edited in the Parameter Details area:

1. Touch the knob.

If the parameter supports AMS modulation, the Parameter Details area will show one or more AMS sources and intensities.

2. Edit the AMS settings in the Parameter Details area.

**Note:** the graphic knobs always show their stored value. Absolute Tone Adjust settings edit these values, just as if you were editing the parameters themselves, and so the graphics will show the results. However, AMS modulation does not edit the stored value, and so the graphics do not include the results of AMS.

Note also that AMS can sometimes modulate parameters outside the range of the stored values, as if you were pushing the parameter beyond the ends of the knob.

## Using the graphic parameters

### Editing knobs

To edit knobs:

1. Touch the knob.

A yellow square will appear around the knob, showing that it has been selected. The Parameter Details area will change to show the name and value of the current parameter, along with other related information.

2. Use any of the data-entry controls to edit the value.

You can use the value slider, the inc/dec buttons, the rotary dial, or the numeric keypad.

As you edit the value, notice that the graphic knob moves, and that the value in the Parameter Details area changes as well.

## EXi Program P0: Play

### 0-1: Main

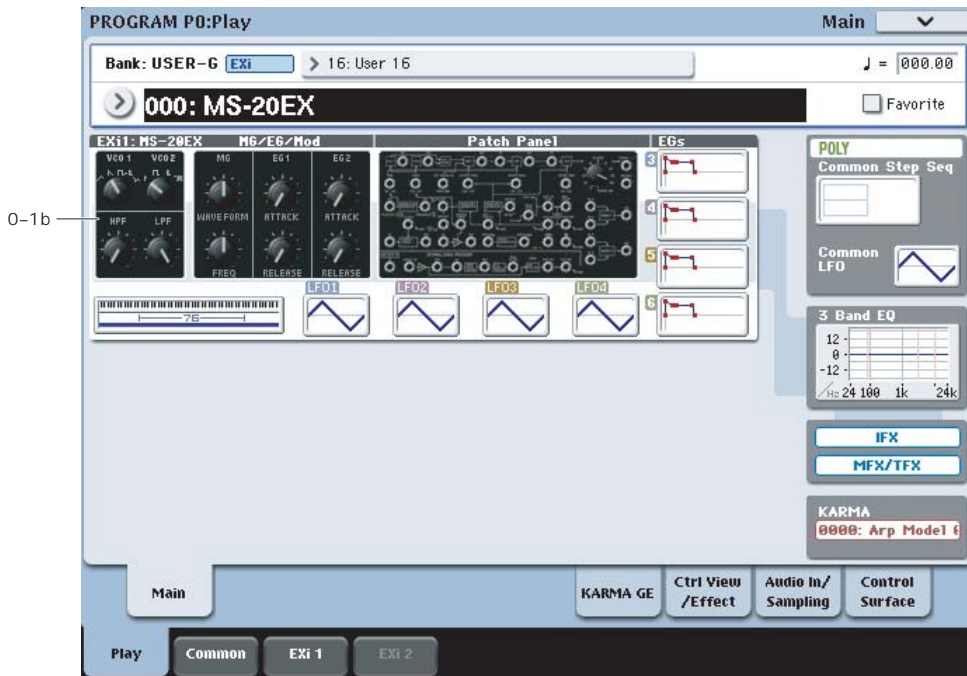

This is the main page of Program mode. For a full description of this page and all of its functions, please see “EXi Program P0: Play” on page 165. This section describes only the overview display, which differs for each individual EXi.

#### 0-1b: Overview and Page Jump

This part of the page shows an overview of the most important settings for the Program’s two EXi instruments. The specific parameters will vary, depending on which EXi are being used. The specific parameters for the MS-20EX are described below.

The graphics give you a quick way to check all of these settings at a glance. They also let you jump instantly to any of the displayed parameters. Just touch one of the sections, and you’ll jump to the page containing its parameters. For instance, if you touch the Filter graphic, you’ll go to the Oscillator and Filter page.

*Tip:* Pressing EXIT several times will always bring you back to this page.

#### Oscillators and Filters

This section shows the waveforms for Oscillators 1 and 2, and the cutoff frequencies for the Highpass and Lowpass filters. Touch this area to jump directly to the Oscillators & Filters page.

#### MG/EG/Mod

This section shows the waveform and frequency of the MG, and the Attack and Release times for EGs 1 and 2. Touch this area to jump directly to the MG, EG, & Modulation page.

#### Patch Panel

This section shows a miniature overview of the Patch Panel, with its cables and jacks. Touch this area to jump directly to the Patch Panel page.

#### EGs and LFOs

##### EG 3...6 Graphics

These show the shapes of the four multi-stage EGs. Touch any of them to jump directly to the corresponding edit page.

##### LFO 1...4 Graphics

These show the waveforms and shapes of the four LFOs. Touch any of them to jump directly to the corresponding edit page.

#### Key Zone

##### Key Zone

This shows the key zones for EXi1 and EXi2, as set on the Common section’s Program Basic page, in relation to the entire MIDI note range. The range of the 61-, 73-, or 88-note keyboard is also shown, as appropriate.

Press this area to jump to the Program Basic page.

#### Common

The graphics along the right side of the screen show the most important Common parameters, which are shared by both EXi in the Program. This section will always show the same parameters, regardless of which EXi are being used.

**Common Voice Assign Mode**

This shows the voice assign mode of the Program—either POLY or MONO.

Press this area to jump to the Program Basic page.

**Common Step Sequencer**

This shows a graphic overview of the Common Step Sequencer.

Press this area to jump to the Common Step Sequencer page.

**Common LFO Graphic**

This shows the waveform of the Common LFO.

Press this area to jump to the Common LFO page.

**3 Band EQ Graphic**

This shows the mid-sweepable 3-band EQ.

Press this area to jump to the EQ page.

**IFX, MFX/TFX**

Press the IFX area to jump to the IFX Routing page.

Press the MFX/TFX area to jump to the MFX Routing page.

**KARMA GE Name**

This shows the name of the selected KARMA GE.

Press this area to jump to the GE Setup/Key Zones page.



# Program P4: Oscillators & Filters

## 4-1: Oscillators & Filters



### 4-1a: Oscillators

#### VOLTAGE CONTROLLED OSCILLATOR 1

**WAVE FORM** [ ^, ▽, □ ↔ ▭, 〰 ]

This sets the basic timbre of Oscillator 1.

**^ (Triangle Wave):** This is a very basic waveform with few harmonics and a soft, rounded tone color. You can create a sine wave by processing the Triangle Wave through the Lowpass Filter. The original MS-20 manual notes that Triangle waves are “excellent for flute, vibes and other such effects.”

**Note:** The Triangle is a little more computationally intensive than the other waveforms, so using it will result in slightly lower polyphony.

**▽ (Sawtooth):** This is the foundation of the traditional, buzzy analog synth sound. The original MS-20 manual describes it this way: “A waveform rich in all the harmonics, and one of the most useful to the synthesist. Used for string, brass, voice and other harmonically rich sounds.”

**□ ↔ ▭ (Square/Pulse Wave):** This is a variable waveform shape, whose timbre depends upon the **PW** setting, as described below.

**〰 (White Noise):** This is an un-pitched sound, containing equal amounts of all frequencies. The original MS-20 manual suggests using this for “wind, surf, gunshot, percussion, and other such effects.”

**PW** [0.00...10.00 (50%...0%)]

This adjusts the pulse width when Oscillator 1’s **Waveform** is set to **Square/Pulse**.

0.00 produces a square wave. Increasing the value produces narrower pulses, until at 10.00 the pulse is so narrow as to be silent.

The original MS-20 didn’t support pulse-width modulation, except by sweeping the knob manually. With the MS-20EX, however, you can modulate **PW** via **AMS**. Try using a medium-speed triangle LFO, or a sweeping EG.

#### More on Pulse Width

Pulse waveforms are simple, rectangular shapes. The Pulse Width sets the percentage of the waveform spent in the “up” position. A few examples are shown in the diagram below. Note that a square wave is just a pulse wave with **PW/PWM** set to 0.00.

The width controls the timbre of the oscillator, from pure and hollow at 0.00 (a square wave) to thin, reedy, and nasal at higher settings.

At the maximum setting of 10.00, the Pulse wave will be silent, since this eliminates the “pulse” altogether.

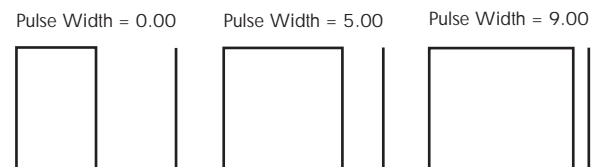



**SCALE** [32', 16', 8', 4']

Adjusts the pitch of Oscillator 1 in steps of an octave. With each halving of the "feet" value, the pitch goes up one octave. For example, 4' is one octave higher than 8', and 16' is one octave lower than 8'.

**VOLTAGE CONTROLLED OSCILLATOR 2****WAVE FORM** [  ,  ,  , RING ]

This sets the basic timbre of Oscillator 2.

 (**Sawtooth**): This produces the traditional, buzzy analog synth sound. For more information, see "WAVE FORM" on page 299.

 (**Square Wave**): This is a hollow-sounding waveform, containing only odd-numbered harmonics. The original MS-20 manual notes that this is used to "simulate reed instruments and other closed pipe sounds."

 (**Pulse Wave**): This is a relatively narrow pulse waveform, with a nasal tone quality and strong upper harmonics. The original MS-20 manual suggests that it be used to "simulate double reed instruments (e.g., the oboe) and certain plucked string sounds (e.g., harpsichord and clavinet)."

**RING (Ring Modulator)**: This setting combines the two VCOs to create sums and differences of all their harmonics, creating a complex tone. The original MS-20 manual describes it this way: "The result is a clangorous, "metallic" sound which is useful for gong, chime and other such effects. **VCO 1** and **VCO 2 SCALE**, **PITCH**, and **PW** all affect the resulting sound, and should be used judiciously to create the desired effect."

**PITCH** [-12.00...+12.00]

This adjusts the pitch of Oscillator 2 up and down by one octave, in one-cent steps. You can create thicker sounds by moving this slightly away from 0.00, so that the two oscillators beat against one another.

**SCALE** [16', 8', 4', 2']

This adjusts the pitch of Oscillator 2 in steps of an octave. Note that the range is one octave higher than that of Oscillator 1.

**PORTAMENTO****TIME** [0.00...10.00]

This controls the amount of time it takes to glide from one pitch to the next.

 This is scaled by MIDI CC#5. You can also enable and disable Portamento using MIDI CC#65 ("Portamento Switch").

**Assigning SW1 or SW2 to Portamento On/Off**

You can use the two assignable switches, SW1 and SW2, to turn portamento on and off.

To do so:

1. Go to Program page 1-8, Controller Setup.
2. Under Panel Switch Assign, set either SW1 or SW2 to Portamento SW (CC#65).

Now, the selected switch will enable and disable Portamento. It will also send the MIDI Portamento controller, CC#65.

 Even if you don't assign SW1/2 to Portamento, you can still use MIDI Controller #65 to turn Portamento on and off.

**FINE TUNE****FINE TUNE** [-5.00...+5.00]

This adjusts the pitch of the oscillators, in steps of 1/5 of a cent (for a total range of +/- 1 semitone).

**FREQUENCY MODULATION**

Each of the FREQUENCY MODULATION controls affects both VCO 1 and VCO 2.

**MG/T.EXT** [0.00...10.00]

If nothing is connected to the patch panel's **TOTAL** input jack, this adjusts the depth of pitch modulation from the MG's Triangle Wave.

If a cable is connected to the **TOTAL** input jack, this controls the depth of pitch modulation from that signal.

For more information, see "TOTAL input jack" on page 309.

 This is scaled by MIDI CC#77.

**EG1/EXT** [0.00...10.00]

If nothing is connected to the patch panel's **FREQ** jack, this controls the depth of pitch modulation from EG 1.

If a cable is connected to the **FREQ** jack, this controls the depth of pitch modulation from that signal.

With nothing connected to the **FREQ** jack, try increasing the **EG1/EXT** value, and then play a note on the keyboard. Notice that the pitch of the note rises and falls corresponding to EG 1's **DELAY**, **ATTACK**, and **RELEASE** controls.

With the normalised connection to EG1, the pitch always starts low, rises to the played note, and then falls again on release. The setting of the EG1/EXT knob determines the low point of this modulation, while the high point stays constant.

You can create a different effect by manually patching the **EG1 OUT** jack into the **FREQ** jack. In this case, the pitch will start at the played note, rise up to the EG1/EXT setting, and then fall back to the played note.

**VCO Mixer**

This mixer controls the levels of the two VCOs into the Highpass Filter.

Note that both filters will show some amount of saturation and overdrive when their input levels are high, and **PEAK** settings are moderate or high. You can control the resulting tone by raising or lowering the VCO levels in this mixer.

**VCO 1 LEVEL** [0.00...10.00]

This adjusts the volume of Oscillator 1.

**VCO 2 LEVEL** [0.00...10.00]

This adjusts the volume of Oscillator 2.

## 4-1b: High Pass Filter

### HPF

This filter cuts out the parts of the sound which are **lower** than the cutoff frequency. You can use this to make timbres sound thinner or more buzzy, or to enhance bass sounds (see “Using the HPF as a sub-oscillator for bass sounds,” below).

**FREQUENCY** [0.00...10.00]

This controls the cutoff frequency of the Highpass Filter.

**PEAK** [0.00...10.00]

Peak controls the resonance of the filter, which emphasizes the frequencies around the cutoff frequency.

When this is set to 0, there is no emphasis, and frequencies beyond the cutoff will simply diminish smoothly.

At medium settings, the resonance will alter the timbre of the filter, making it sound more nasal, or more extreme.

At very high settings, the resonance can be heard as a separate, whistling pitch. Near the maximum setting, the filter will self-oscillate.

### PEAK and filter saturation

If the input level is high, raising the **PEAK** setting will cause increasing amounts of saturation and overdrive, creating a more aggressive tone. To control this, raise or lower the input level at the source—for instance, in the VCO MIXER.

### Using the HPF as a sub-oscillator for bass sounds

With **PEAK** set relatively high, and **FREQUENCY** turned down low, the HPF can—somewhat counter-intuitively—be used to enhance low-end harmonics, creating thunderously deep bass sounds. To do so:

1. Start with a simple bass sound.
  2. On the Patch Panel, connect the KBD CV OUT to the HPF CUTOFF FREQ input.
- This allows the HPF to track the keyboard.
3. Set the HPF **PEAK** to around 7 or 8.
  4. Set the HPF **FREQUENCY** very low, but not quite at 0.
  5. Set the **EG2/EXT** knob to about 5.
  6. While playing the sound, adjust the **FREQUENCY** and **EG2/EXT** settings so that the filter resonance tracks the pitch correctly in the intended playing range.

With this setup, the resonance will only match the oscillator pitches over about one and a half octaves.

### CUTOFF FREQUENCY MODULATION (HPF)

**MG/T.EXT** [0.00...10.00]

If nothing is connected to the patch panel’s **TOTAL** input jack, this adjusts the depth to which the MG will modulate the filter cutoff frequency.

If a cable is connected to the **TOTAL** input jack, this controls the depth of modulation from that signal.

For more information, see “TOTAL input jack” on page 309.

**EG2/EXT** [0.00...10.00]

If nothing is connected to the HPF’s **CUTOFF FREQ** input jack, this adjusts the depth to which EG 2 will modulate the filter cutoff frequency.

If a cable is connected to the HPF’s **CUTOFF FREQ** input jack, this controls the depth of modulation from that signal.

## 4-1c: Low Pass Filter

### LPF

The Lowpass Filter cuts out the parts of the sound which are **higher** than the cutoff frequency. This is the most common type of filter, and is used to make bright timbres sound darker.

**FREQUENCY** [0.00...10.00]

This controls the cutoff frequency of the Lowpass Filter.

**MIDI** This is scaled by MIDI CC#74.

**PEAK** [0.00...10.00]

Peak controls the resonance of the filter, which emphasizes the frequencies around the cutoff frequency. For more information, see “PEAK,” above.

**MIDI** This is scaled by MIDI CC#71.

### CUTOFF FREQUENCY MODULATION (LPF)

**MG/T.EXT** [0.00...10.00]

If nothing is connected to the **TOTAL** input jack, this adjusts the depth to which the MG will modulate the filter cutoff frequency.

If a cable is connected to the **TOTAL** input jack, this controls the depth of modulation from that signal.

For more information, see “TOTAL input jack” on page 309.

**EG2/EXT** [0.00...10.00]

If nothing is connected to the LPF’s **CUTOFF FREQ** input jack, this adjusts the depth to which EG 2 will modulate the filter cutoff frequency.

If a cable is connected to the LPF’s **CUTOFF FREQ** input jack, this controls the depth of modulation from that signal.

**MIDI** This is scaled by MIDI CC#79.

## 4-1d: PITCH

**BEND RANGE** [0.00...12.00]

This sets the maximum amount of pitch bend up and down, in semitones and cents, as controlled by JS X. To use another AMS source for pitch bend, modulate the **TRANSPOSE** parameter instead.

**BEND RANGE** is not modulatable via AMS.

**TRANPOSE** [-24.00...+24.00]

This controls the coarse tuning, in half-steps and cents, up or down two octaves. You can modulate this smoothly via AMS.

**4-1e: PAN & ANALOG****PAN** [Random, L001...C064...R127]

This controls the stereo pan of the MS-20EX, at the very end of the signal chain. A setting of **L001** places the sound at the far left, **C064** in the center, and **R127** to the far right.

When this is set to **Random**, the pan position will be different for each note-on.

You can also set this Pan parameter directly from the Control Surface knobs. To do so:

1. Press the Control Surface Timbre/Track button.
2. Set the MIXER KNOBS switch to INDIVIDUAL PAN.
3. Move Knob 1 to set the pan for EXi 1, and Knob 2 to set the pan for EXi 2.

**MIDI** You can also control pan via MIDI Pan (CC#10). A CC#10 value of 0 or 1 places the sound at the far left, 64 places the sound at the location specified by the “Pan” parameter, and 127 places the sound at the far right.

Note: you can select Random pan only from the on-screen UI, and not from AMS, MIDI or the Control surface.

**ANALOG** [0.00...10.00]

This models the instability of an analog system by adding subtle randomization to the VCO and VCF frequencies.

This parameter is not modulatable.

**4-1f: Parameter Details**

When you touch a knob, a yellow square appears around it, showing that it has been selected.

This area shows details for the selected knob, including its parameter group and parameter name, its exact value, and its AMS assignments.

**Individual parameters and AMS**

The **BEND RANGE** and **ANALOG** parameters are not modulatable. **VCO1/2 WAVE FORM**, **VCO 1/2 SCALE**, and **PAN** have only one AMS source and Intensity, without Intensity Modulation. The rest of the parameters on this page can be modulated by two AMS sources, as described below.

**(Parameter group)**

This shows the group of the parameter (such as **VCO MIXER**).

**(Parameter name) [range depends on parameter]**

This shows the name and exact value of the parameter. You can edit the parameter value with any of the standard data-entry controls.

**AMS** [List of AMS Sources]

This selects a modulation source to control the selected parameter. For a list of AMS sources, see “Alternate Modulation Source (AMS) List” on page 1091.

**Intensity** [range depends on parameter]

This controls the depth and direction of the AMS modulation. For unipolar parameters, the range is the same as that of the selected parameter, in both positive and negative directions. For instance, if the parameter range is 0.00...10.00, the Intensity range will be -10.00...+10.00.

For bipolar parameters, including **VCO 2 PITCH**, **FINE TUNE**, **TRANPOSE**, and **MIXERS 1 & 2 LEVELS A & B**, the range is twice that of the original parameter. For instance, if the original parameter range is -12.00...+12.00, the Intensity range will be -24.00...+24.00. This allows full modulation of the parameter, regardless of the initial setting.

In some cases, you can use AMS to modulate the parameter outside of its original range, for a wider range of values.

**Int. Mod AMS** [List of AMS Sources]

You can modulate the main AMS Intensity from another AMS source. This selects that source.

For a list of AMS sources, see “Alternate Modulation Source (AMS) List” on page 1091.

**Intensity** [range depends on parameter]

This controls the depth and direction of the Intensity Mod AMS. The result is summed with the main AMS Intensity to produce the final modulation amount.

**▼ 4-1: Page Menu Commands**

The number before each command shows its ENTER + number-key shortcut. For more information on these shortcuts, see “ENTER + 0-9: shortcuts for menu commands” on page 147.

- 0: **Write Program**. For more information, see “Write Program” on page 147.
- 1: **Exclusive Solo**. For more information, see “Exclusive Solo” on page 147.



## Program P5: MG, EG, & Modulation

### 5-1: MG, EG, & Modulation

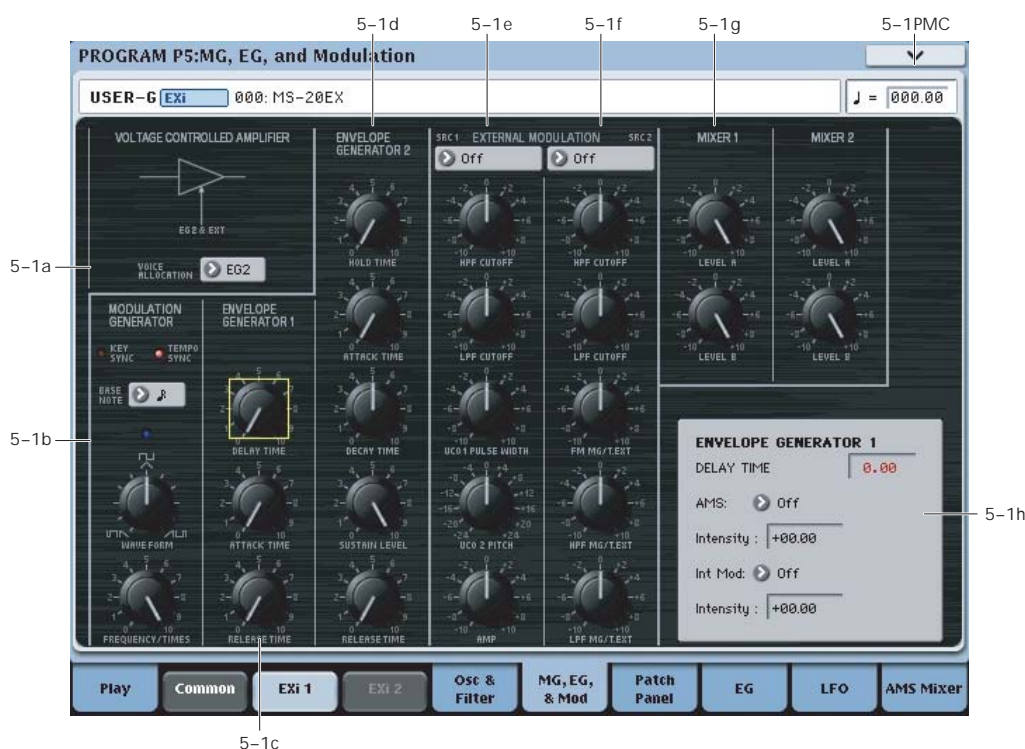

#### 5-1a: VOLTAGE CONTROLLED AMPLIFIER

##### VOICE ALLOCATION [EG1...EG6]

When the EG selected here completes its release stage, the voice will be silenced, and its processor resources freed.

Normally, you should leave this at the default setting, EG2.

If EGs other than EG2 are modulating volume (see below), then select the volume-related EG with the longest release time.

**Note:** the EG selected here cannot be retrigged once it enters its release phase.

##### What does this mean, and when is it useful?

KRONOS allocates processing power automatically as you play and release notes. In order to do this, the system needs to know when a voice has finished playing.

With most EXi, the system does this by looking at the dedicated Amp EG; when the Amp EG completes its release, the system knows that the voice has finished.

The MS-20EX is more complicated than most EXi. Depending on the Patch Panel and AMS settings, several EGs may act together to control the output volume. For instance:

- EG 1 and EGs 3-6 may be routed to the Patch Panel's VCA INITIAL GAIN input
- EGs 3-6 may control the VOLUME knob via AMS

- Via AMS, EGs 3-6 may also control the levels of other modulation sources (such as EGs 1 & 2, the MG, LFOs, etc.) routed through MIXER 1 or MIXER 2, and then patched to the VCA INITIAL GAIN input

To handle all of these possible cases, instead of using a fixed "Amp EG" to determine when the voice is finished playing, the VOICE ALLOCATION parameter lets you select which EG to use.

For best results with any of these special-case setups, set VOICE ALLOCATION to use the volume-related EG with the longest release time.

#### 5-1b: MODULATION GENERATOR (MG)

##### AMSsource

The MG is shared between all MS-20EX voices, similar to the Common LFO. For per-voice modulation, use LFOs1-4 instead.

The saw/triangle and pulse/square waveforms are both generated all of the time, and available separately on the Patch Panel. Each is also available as an AMS source, named MG Tri and MG Pulse, respectively. Note that the AMS versions will have slightly softer edges than the signals available on the Patch Panel, and via the External Modulation sections.

**TEMPO SYNC [ON, OFF]**

Touch the text/LED area to turn **TEMPO SYNC** on and off.

**On (LED lit):** When **TEMPO SYNC** is **On**, the MG synchronizes to the system tempo, as set by either the Tempo knob or MIDI Clock. The MG speed is controlled by the combination of the **BASE NOTE** and **FREQUENCY/TIMES** parameters, below.

**Off (LED dark):** When **TEMPO SYNC** is **Off**, the **FREQUENCY/TIMES** knob determines the speed of the MG, and the **BASE NOTE** setting has no effect.

This parameter is not modulatable via AMS.

**KEY SYNC [ON, OFF]**

Touch the text/LED area to turn **KEY SYNC** on and off.

If this setting is **ON**, the phase is reset for the first note-on in each legato phrase. Subsequent notes in a chord, or notes played legato, do not cause the phase to be reset.

This parameter is not modulatable via AMS.

**BASE NOTE [1/1...1/32]**

When **TEMPO SYNC** is **ON**, this sets the basic speed of the MG, relative to the system tempo. The values range from a 32nd note to a whole note, including triplets. This value is then multiplied by the **FREQUENCY/TIMES** knob, below.

When **TEMPO SYNC** is **OFF**, this parameter has no effect.

This parameter is not modulatable via AMS.

**WAVE FORM [ □ ▽ ... ▽ ▽ ▽ ... ▽ ▽ ]**

This controls the waveform of the **MODULATION GENERATOR**. The MG always generates both the Rectangle and Sawtooth/Triangle waveforms, and each is available simultaneously via the Patch Panel. The **WAVE FORM** knob controls the pulse width of the Rectangle wave, and makes the Sawtooth/Triangle “lean” from left to right, as shown in the graphics.

**FREQUENCY/TIMES [0.00...10.00/16...1]**

If **TEMPO SYNC** is **OFF**, this controls the frequency of the MG.

If **TEMPO SYNC** is **ON**, this multiplies the length of the **BASE NOTE**. For instance, if the **BASE NOTE** is set to a sixteenth note, and Times is set to 3, the MG will cycle over a dotted eighth note. Note that higher values mean a faster MG.

**Frequency/Times LED**

This LED gives a visual indication of the LFO speed. Note that the LED is **on** when the MG’s pulse/square waveform is **low**. Initially, this seems like the opposite of what one might expect. When using the MG to trigger the EGs, however, this makes perfect sense: the EGs start when the LED goes on, and release when the LED goes off.

**5-1c: ENVELOPE GENERATOR 1**

By default, EG 1 is triggered by note-ons. However, you can use the Patch Panel’s **TRIG IN** or **EG 1 TRIG IN** jacks to trigger it from a different source, such as the MG, AMS sources, or the ESP’s **TRIG OUT** jack. For more information, see “TRIG IN jack” on page 311.

EG1 is normalled to VCO frequency modulation (scaled by the **EG1/EXT** knob), as well as the MVCA control input (see “6-1f: Modulation VCA (MVCA)” on page 312).

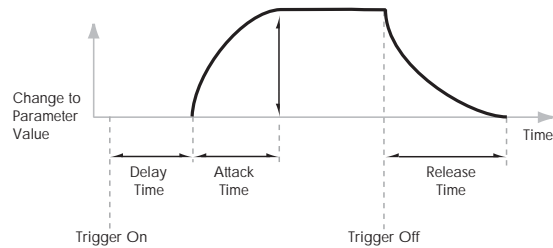
**DELAY TIME [0.00...10.00]**

Adjusts the time from when the trigger occurs (e.g., note-on) until the **ATTACK TIME** starts.

For standard attack-release behavior, set the **DELAY TIME** to 0.00.

**ATTACK TIME [0.00...10.00]**

Adjusts the time from the end of the **DELAY TIME** until the EG reaches its maximum value.

**RELEASE TIME [0.00...10.00]**

Adjusts the time from when the trigger is released (e.g., note-off) until the level decays to zero.

**5-1d: ENVELOPE GENERATOR 2**

By default, EG 2 is triggered by note-ons. However, you can use the Patch Panel’s **TRIG IN** jack to trigger it from a different source, such as the MG, AMS sources, or the ESP’s **TRIG OUT** jack. For more information, see “TRIG IN jack” on page 311.

EG 2 is hard-wired to the VCA, and also normalled to control the HPF and LPF. You can easily use other EGs for the filters, via AMS; using other EGs for the VCA is possible but slightly more tricky, as described under “Using EGs 3-6 to control the amplitude” on page 305.

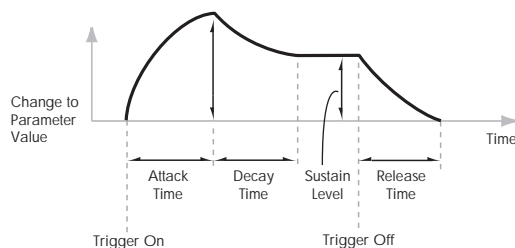

**HOLD TIME [0.00...10.00]**

Adjusts the time for which the input state of the trigger signal (e.g., note-on) is held after the trigger is released.

If the EG is triggered by a very short pulse, it may not have time to complete its attack and decay times before going into release. Increasing the **HOLD TIME** effectively makes the trigger pulse longer, giving the EG more time to complete its attack and decay.

*EG 2 HOLD TIME*

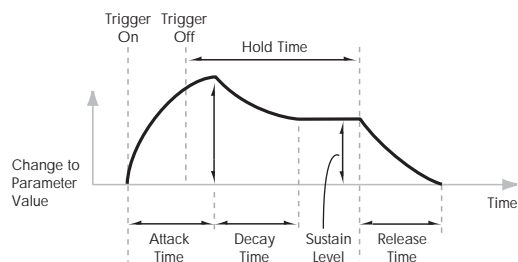

**ATTACK TIME [0.00...10.00]**

Adjusts the time from the EG trigger (e.g., note-on) until the EG reaches its maximum value.

**MIDI** This is scaled by MIDI CC#73.

**DECAY TIME [0.00...10.00]**

Adjusts the time the EG takes to descend from the peak to the sustain level. It also controls the rate at which **SUSTAIN LEVEL**, below, responds to AMS modulation.

**MIDI** This is scaled by MIDI CC#75.

**SUSTAIN LEVEL [0.00...10.00]**

Adjusts the sustain level. The EG will stay at this level until the trigger is released (such as when the note is released). Unlike most other EGs, this level responds to AMS modulation in realtime, moving at the programmed **DECAY TIME**.

**MIDI** This is scaled by MIDI CC#70.

**Note:** with the default connection to the **HPF** and **LPF** frequencies, this setting has a slightly unusual effect. The **SUSTAIN LEVEL** always produces the same effect as the setting of the **FREQUENCY** knob. The **EG2/EXT** setting controls the intensity of the filter modulation during the Attack, Decay, and Release portions of the envelope, but does not affect the Sustain at all.

Effectively, the EG shifts up and down **inversely** to the **SUSTAIN LEVEL**, as shown below. When the **SUSTAIN** is high, the EG shifts down; when the **SUSTAIN** is low, the EG shifts up.

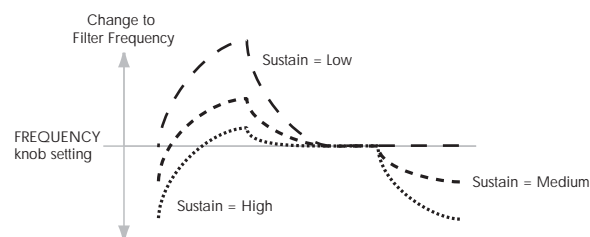

**RELEASE TIME [0.00...10.00]**

Adjusts the time from the trigger release (e.g., note-off) until the level decays to zero.

**MIDI** This is scaled by MIDI CC#72.

**Using EGs 3–6 to control the amplitude**

EG 2 is always connected to the VCA. It's possible, however, to force the VCA to its maximum value at all times, and then use AMS modulation of the main **VOLUME** knob to control the amplitude from any of the multi-segment EGs 3–6. To do so:

1. On the Patch Panel page, select the main **VOLUME** knob.
2. Set the **VOLUME** knob to 0.
3. Set the **VOLUME AMS Intensity** to +10.00.
4. Assign the desired EG (3–6) as the knob's AMS source.
5. Set the **VOICE ALLOCATION** parameter to the same EG.
6. In the Patch Panel, select the Mod Switch jack, which looks like this: 
7. Set the Mod Switch AMS Source to AMS Mixer 1.
8. In AMS Mixer 1, set the **Type** to Gate, the **Source** to Note Number, and the **Threshold** to -99.
9. Set both **Below Threshold** and **At & Above Threshold** to fixed values of +33.

These settings produce a "5 volt" signal on the Patch Panel, which, when connected to the **INITIAL GAIN** input, sets the VCA to its maximum level. This lets you control the amplitude entirely via the **VOLUME AMS**.

10. On the Patch Panel, connect the Mod Switch jack to the **VCA INITIAL GAIN** input.

11. For the EG assigned in step 4, set up the times, levels, and curvatures as desired.

Remember to use curvature on the EG segments, for an analog feel!

**5-1e: EXTERNAL MODULATION 1**

**Source [Off, MG Tri, MG Pulse, EG 1, EG 1 REV, EG 2, EG 2 REV, List of AMS Sources]**

This selects the modulation source to control the parameters below. For a list of AMS sources, see "Alternate Modulation Source (AMS) List" on page 1091.

**HPF CUTOFF [-10.00...+10.00]**

Specifies the depth and direction of the modulation applied to the high-pass filter (HPF) **CUTOFF FREQUENCY**.

**LPF CUTOFF [-10.00...+10.00]**

Specifies the depth and direction of the modulation applied to the low-pass filter (LPF) **CUTOFF FREQUENCY**.

**VCO1 PULSE WIDTH [-10.00...+10.00]**

Specifies the depth and direction of the modulation applied to the oscillator 1 (VCO1) **PULSE WIDTH**.



**VCO2 PITCH** [-24.00...+24.00]

Specifies the depth and direction of the modulation applied to the oscillator 2 (VCO2) PITCH, in semitones.

**AMP** [-10.00...+10.00]

Specifies the depth and direction of the modulation applied to the amp (VCA). This scales the combined effect of the VOLUME knob and its AMS modulation.

---

**5-1f: EXTERNAL MODULATION 2****Source** [Off, MG Tri, MG Pulse, EG 1, EG 1 REV, EG 2, EG 2 REV, List of AMS Sources]

This selects the modulation source to control the parameters below. For a list of AMS sources, see "Alternate Modulation Source (AMS) List" on page 1091.

**HPF CUTOFF** [-10.00...+10.00]

Specifies the depth and direction of the modulation applied to the high-pass filter (HPF) CUTOFF FREQUENCY.

**LPF CUTOFF** [-10.00...+10.00]

Specifies the depth and direction of the modulation applied to the low-pass filter (LPF) CUTOFF FREQUENCY.

**FM MG/T.EXT** [-10.00...+10.00]

Specifies the depth and direction of the modulation applied to FREQUENCY MODULATION MG/T.EXT.

**HPF MG/T.EXT** [-10.00...+10.00]

Specifies the depth and direction of the modulation applied to the high-pass filter CUTOFF FREQUENCY MODULATION MG/T.EXT.

**LPF MG/T.EXT** [-10.00...+10.00]

Specifies the depth and direction of the modulation applied to the low-pass filter CUTOFF FREQUENCY MODULATION MG/T.EXT.

---

**5-1g: Mixers****MIXER 1**

This controls the input volumes for the Patch Panel's Mixer 1. For more information, see "MIXER 1" on page 313.

**LEVEL A** [-10.00...+10.00]

This sets the level and polarity of the first input.

**LEVEL B** [-10.00...+10.00]

This sets the level and polarity of the second input.

**MIXER 2**

This controls the input volumes for the Patch Panel's Mixer 2. For more information, see "MIXER 2" on page 313.

**LEVEL A** [-10.00...+10.00]

This sets the level and polarity of the first input.

**LEVEL B** [-10.00...+10.00]

This sets the level and polarity of the second input.

---

**5-1h: Parameter Details**

When you touch a knob, a yellow square appears around it, showing that it has been selected.

This area shows details for the selected knob, including its parameter group and parameter name, its exact value, and its AMS assignments.

**Individual parameters and AMS**

The EXTERNAL MODULATION knobs, BASE NOTE parameter, and TEMPO SYNC and KEY SYNC switches are not modulatable.

The rest of the parameters on this page can be modulated by AMS, as described below.

**(Parameter group)**

This shows the group of the parameter (such as VCO MIXER).

**(Parameter name) [range depends on parameter]**

This shows the name and exact value of the parameter. You can edit the parameter value with any of the standard data-entry controls.

**AMS** [List of AMS Sources]

This selects a modulation source to control the selected parameter. For a list of AMS sources, see "Alternate Modulation Source (AMS) List" on page 1091.

**Intensity** [range depends on parameter]

This controls the depth and direction of the AMS modulation. For more information, see "Intensity" on page 302.

**Int. Mod AMS** [List of AMS Sources]

You can modulate the main AMS Intensity from another AMS source. This selects that source.

**Intensity** [range depends on parameter]

This controls the depth and direction of the Intensity Mod AMS. The result is summed with the main AMS Intensity to produce the final modulation amount.

---

**▼ 5-1: Page Menu Commands**

The number before each command shows its ENTER + number-key shortcut. For more information on these shortcuts, see "ENTER + 0-9: shortcuts for menu commands" on page 147.

- **0: Write Program.** For more information, see "Write Program" on page 147.
- **1: Exclusive Solo.** For more information, see "Exclusive Solo" on page 147.

## Program P6: Patch Panel

### 6-1: Patch Panel

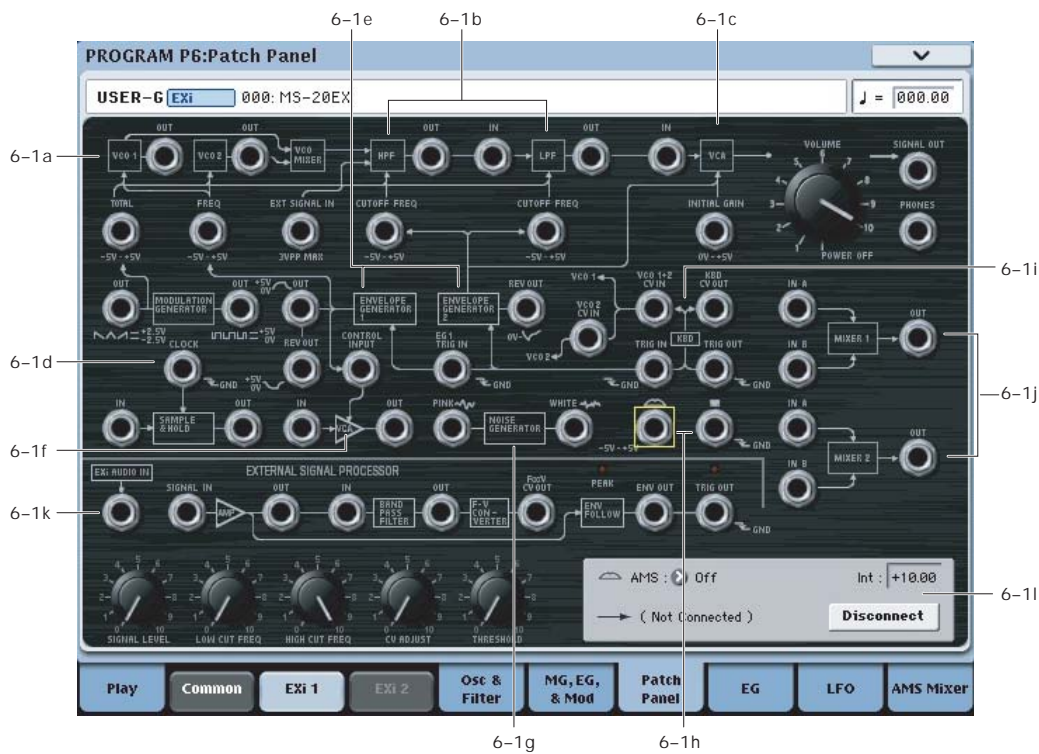

### Using the Patch Panel

#### Basic patching rules

Most of the main sections of the MS-20EX, including the VCOs, filters, MG, EGs, and so on, are connected by default, even without using any patch cables. The lines and arrows on the Patch Panel show these “normal” signal paths.

Plugging a cable into an input jack disconnects the “normal” path, and uses the signal from the cable instead. For example, the MG is normalled to the TOTAL input jack. If you connect the EG1 OUT jack to the TOTAL input, this disconnects the MG.

Each input can be connected to a single output, and no more (although a single *output* can be connected to multiple *inputs*, as described below). If you want to route two outputs to a single input, use one of the mixers to merge the outputs first.

Plugging a cable into an output jack lets you use the signal elsewhere on the patch panel, and does not interrupt the “normal” path. You can also connect a single output to any number of inputs, if you like; this is sometimes called a “mult.” The signal strength remains the same, as if you were using a distribution amplifier.

Connections from one input to another, or from one output to another, are not allowed.

#### Making connections

To make a connection between two patch points:

1. **Touch one of the two jacks (either input or output).**

A yellow square will appear around the selected jack. The Detail Panel will also show the name of the selected jack, and what it is connected to.

2. **Touch the same jack again.**

The yellow square will begin to blink, showing that you’re about to make a connection. To cancel this and return to the normal selected state, just touch the same jack a third time.

3. **Touch the other jack.**

The two jacks will now be connected.

#### Deleting connections

To delete a connection between two patch points:

1. **Touch the input jack.**

Note: you can also select the output jack. However, if the output is connected to more than one input, all of the connections from that output will be affected.

2. **Press the Disconnect button in the Detail Panel.**

The selected connection will be deleted.

To delete all connections from an output:

1. **Touch the output jack.**

2. **Press the Disconnect button in the Detail Panel.**

All of the output’s connections will be deleted. This is convenient if an output has been connected to multiple inputs, and you want to clear all of them at once.

### Clearing all connections from the Patch Panel

To completely clear the Patch Panel, so that you can start from scratch:

1. Open the menu, and select the **Delete All Connections** command.

All connections will be deleted.

### Different jacks have different voltage scales

Pay attention to the voltage indications (0~+5, -5V~+5V, 5Vp-p, GND, etc.) on the Patch Panel, and their relationships to the block diagram and signal flow chart.

For instance, if you connect a -5~+5V control signal to a 0~+5V input jack, nothing will happen during the -5~0V portion of the control signal. It will only operate from 0V to +5V. Always consider both the characteristics of the output and the input.

*Patch Panel modifications - new inputs/outputs shown in red*

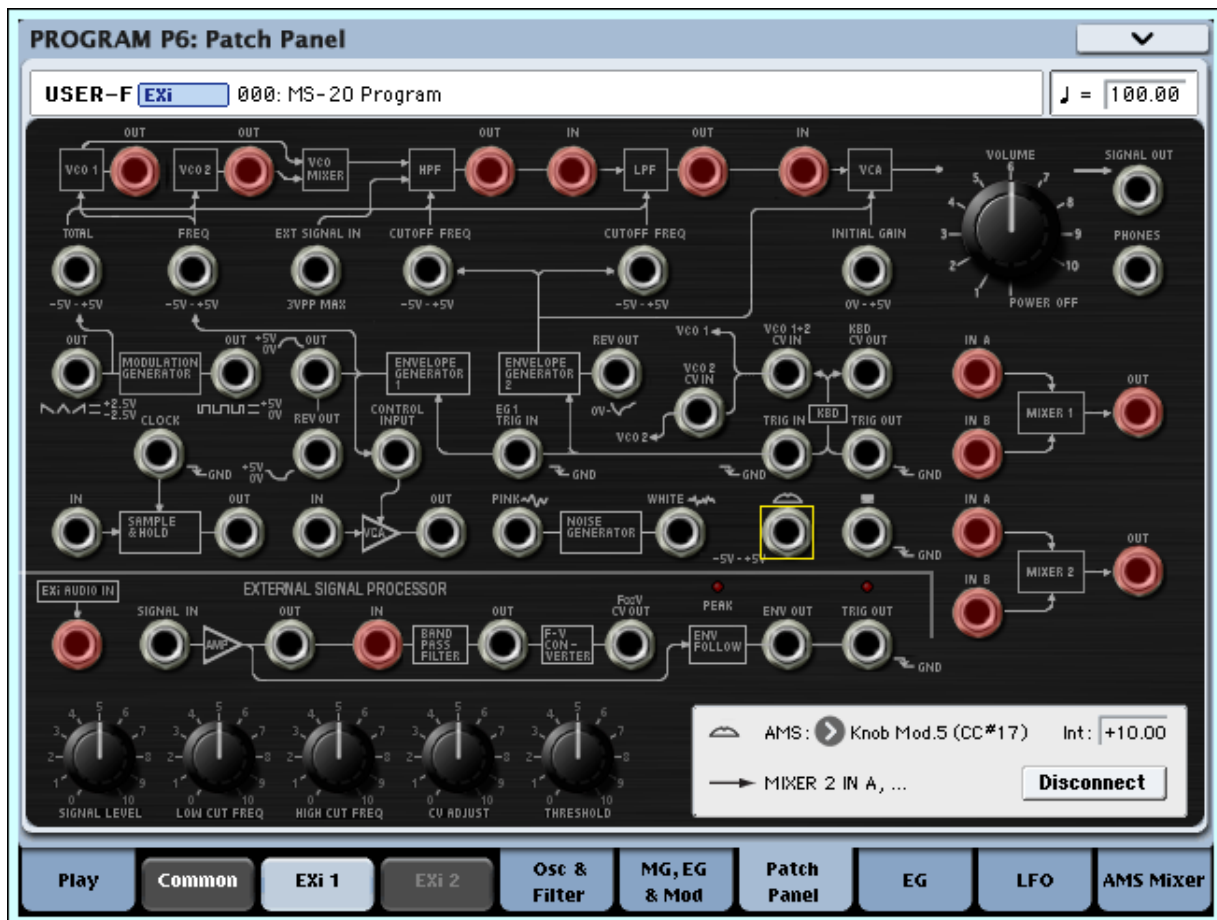

### Patch Panel modifications

In comparison to the original MS-20, the MS-20EX has some important additional features on the Patch Panel. These include:

- Individual access to each of the two oscillators, two filters, and final VCA
- Separate EXi AUDIO INPUT and BAND PASS FILTER IN, which allow you to route signals through the band pass filter and/or frequency-to-cv converter, while using the audio input separately
- Dual two-input mixers with phase inversion

These modifications open up many new possibilities, such as:

- Route VCO 1 through the HPF, and VCO 2 through the LPF (or vice-versa)

- Mix VCO 1 and VCO 2 together, and then route the mix through the HPF and LPF in parallel, instead of in series
- Use AMS of the MIXER LEVELS to modulate the relative levels of these parallel filters, from physical controllers, LFOs, EGs, etc.
- Route any audio source (such as a VCO or the NOISE GENERATOR) through the BAND PASS FILTER, and then mix the results back in to either the HPF or LPF, or to the final VCA
- Invert the polarity of a modulation or audio signal via MIXER 1 or 2
- Use VCO1 or 2 to modulate LPF or HPF cutoffs, or VCA gain
- Reverse the order of the LPF and HPF (most noticeable with high PEAK settings)
- ...and many more avenues for you to explore on your own.

**Tip: Creating self-triggering patches**

Normally, new notes and EGs 1 and 2 are triggered by playing notes on the keyboard. They don't have to be, however. You can use the MG Square/Pulse output, the Trig Out of the External Signal Processor, or AMS signals from the Wheel or Switch jacks to trigger one or both EGs.

**Note:** EGs 1 and 2 trigger when the input is at 0 ("low"), such as when the MG Square/Pulse is in the bottom portion of the waveform. The MG's indicator LED is on during this portion of the waveform.

You can also use AMS (such as LFOs) to reset EGs 3-6, if desired. Finally, the Common Step Sequencer and LFO can also be reset via a selection of controllers, including the Vector EG CCs.

Even when a patch is self-triggering, it will only play when a note is played on the keyboard, held by the damper pedal, or held via the Program Basic page's **Hold** parameter. When the note is released (by lifting up on the keyboard or damper pedal, or turning off **Hold**), the EG selected by the **VOICE ALLOCATION** parameter will automatically enter its release phase, and will no longer re-trigger. All other EGs will continue to re-trigger, according to the Patch Panel and AMS settings.

In some cases, you may want some elements of the patch to re-trigger automatically, while others are still triggered from the keyboard. To allow the keyboard to act as a trigger while you are holding the sustain pedal (or while **Hold** is enabled):

1. Select the **KBD TRIG OUT** jack.
2. In the **Parameter Details** box, set **Trigger On to Note Gate**.

For more information, see "KBD TRIG OUT jack" on page 316.

**6-1a: VCOs 1 and 2**



For descriptions of the VCO parameters, see "4-1a: Oscillators" on page 299.

**(VCO 1) OUT jack**

This Patch Panel modification provides the output of VCO 1.

**(VCO 2) OUT jack**

This Patch Panel modification provides the output of VCO 2.

**TOTAL input jack**

This input modulates the frequencies of VCOs 1 and 2, the HPF, and the LPF. It's normalled to the MG sawtooth/triangle output, but you can use patch cables to connect any other modulation source.

Each of the destinations has a knob to scale the amount of modulation from the TOTAL input. For more information, see:

- VCO 1 and 2 pitch: "MG/T.EXT" on page 300
- HPF frequency: "MG/T.EXT" on page 301
- LPF frequency: "MG/T.EXT" on page 301

**FREQ input jack**

This input modulates the frequencies of VCOs 1 and 2. The signal is scaled by the EG1/EXT knob, as described under "EG1/EXT" on page 300.

**VCO CV (Control Voltage) inputs**



**VCO 1+2 CV IN jack**

This controls the basic pitch of both VCO1 and VCO2.

Normally, this signal comes from the notes played on the keyboard (or via MIDI). You can patch other signals into this jack to create special effects, or to follow the pitch of an external audio input.

**VCO 2 CV IN jack**

This is similar to "VCO 1+2 CV IN jack," above, but affects VCO 2 only.

**6-1b: HPF and LPF**

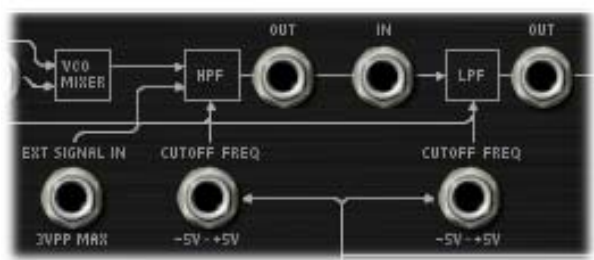

**EXT SIGNAL IN jack**

This is a direct input to the HPF, summed with the output of the VCO Mixer.

**(HPF) CUTOFF FREQ input jack**

This input modulates the cutoff frequency of the Highpass Filter.

**(HPF) OUT jack**

This Patch Panel modification provides the output of the Highpass Filter.



**(LPF) CUTOFF FREQ input jack**

This input modulates the cutoff frequency of the Lowpass Filter.

**(LPF) IN jack**

This Patch Panel modification provides a direct input to the Lowpass Filter.

**(LPF) OUT jack**

This Patch Panel modification provides the output of the Lowpass Filter.

**6-1c: VCA, VOLUME, and outputs****VCA IN jack**

This Patch Panel modification provides a direct input to the main VCA.

**INITIAL GAIN input jack**

The VCA is internally patched to the output of EG 2.

This jack allows an external controller to vary the VCA *in addition to* EG 2.

When the sum of both controllers reaches 5 volts, no further changes in volume will occur.

**VOLUME [POWER OFF, 0.01...10.00]**

This controls the basic volume level of the MS-20EX. Note that you can modulate this via AMS, for each individual voice; for more information, see “Using EGs 3-6 to control the amplitude” on page 305.

**The Control Surface and volume**

You can also control the volumes of EXi 1 and 2 directly from the Control Surface sliders. These volume levels are separate parameters, in addition to the individual EXi Amp Levels. To do so:

1. Press the Control Surface Timbre/Track button.
2. Move Slider 1 to set the volume for EXi 1, and Slider 2 for EXi 2.

**MIDI and volume**

**MIDI** You can control the Program’s overall volume via MIDI using both Volume (CC#7) and Expression (CC#11). When used one at a time, the two controllers work in exactly the same way: a MIDI value of 127 is equal to the **VOLUME** setting, and lower values reduce the volume.

If both CC#7 and CC#11 are used simultaneously, the one with the *lower* value determines the maximum volume, and the one with the higher value scales down from that maximum.

**SIGNAL OUT jack**

On the original MS-20, this was the final output. With the MS-20EX, you may find it useful for routing the overall output signal back into the patch—such as for creating a feedback loop.

Note that connecting to this jack does not mute the output signal.

**PHONES output jack**

On the original MS-20, this was used for headphones (of course!). With the MS-20EX, you can use it to route the overall output signal back into the patch, as with the “SIGNAL OUT jack,” above.

Since its original purpose was to drive headphones, the gain of the **PHONES** output is about 15dB higher than that of the **SIGNAL OUT**. It also clips (with distortion) at around -5dB below the max output level.

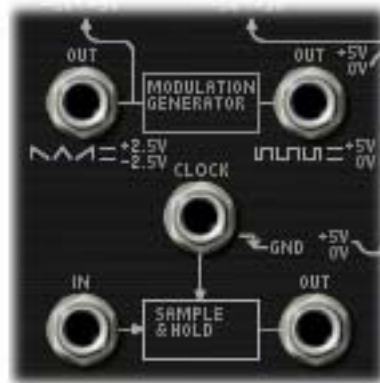
**6-1d: MODULATION GENERATOR and SAMPLE & HOLD****MODULATION GENERATOR (MG)**

The MG has separate outputs for its two basic waveforms, so that you can use both simultaneously.

For descriptions of the MG parameters, see “5-1b: MODULATION GENERATOR (MG)” on page 303.

**OUT jack (saw/triangle)**

This is the output for the saw/triangle waveform. The signal is centered around zero, from -5.00 to +5.00.

**OUT jack (pulse/square)**

This is the output for the pulse/square waveform. The signal is unipolar, from 0.00 to 10.00.

**Note:** when used through AMS and EXTERNAL MODULATION, the signal ranges for both the saw/triangle and pulse/square are -10.00 to +10.00.

**SAMPLE & HOLD**

The **SAMPLE & HOLD** can generate a stepped output from any varying input. You can use this to create random filter or pitch effects, arpeggios, quantized LFOs or EGs, and so on.

To use the **SAMPLE & HOLD**, there must be a trigger source connected to the **CLOCK** input, and some sort of signal (such as the **NOISE GENERATOR**, **VCOs**, **AMS** sources etc.) connected to the **IN** jack.

When the **CLOCK** input is high, the **OUT** jack will carry a slightly filtered version of the signal from the **IN** jack. If the **CLOCK** input goes high for a very brief period of time, then the input from that instant will be “held” at the output. The output then stays “held” until the next time that the **CLOCK** input goes high.

**Important:** the trigger at the **CLOCK** input must be very brief. When using the MG Rectangle waveform as the trigger, for instance, turn the **WAVEFORM** knob to the extreme right position; this produces a very sharp pulse.

With this caveat in mind, you can use the MG or the LFOs to trigger the **CLOCK** at regular intervals, or trigger it manually using a switch, keyboard trigger out, or other signal.

### CLOCK input jack

This input controls the timing of the S&H, as described above.

### IN jack

This is the input to the S&H. You can connect this to the noise generator, a VCO, an LFO, etc.

### OUT jack

This is the output of the S&H, which carries the held, “steppy” signal.

### Creating the classic sample-and-hold effect

To create the classic random-stepping sample-and-hold effect, for rhythmic, bubbling filters or “computer noise” pitch effects:

1. Connect the **WHITE** or **PINK** output of the **NOISE GENERATOR** to the **SAMPLE & HOLD IN** jack.
2. Connect the **MG RECTANGLE** output to the **CLOCK** input.
3. On the **MG, EG, & MODULATION** page, turn the **MG WAVEFORM** knob all the way to the right.
4. Connect the **SAMPLE & HOLD OUT** to the modulation destination.

For instance, the **LPF CUTOFF FREQ IN** jack, or the **VCO 1+2 CV IN** jack.

5. Adjust the **MG FREQUENCY** to control the speed of the sample & hold effect.

### Generating a random value at note-on

Using noise as the input signal, you can generate a random value at note-on by connecting the **KBD TRIG OUT** to the **CLOCK** input. This will also let through additional values at note-off, which may or may not be desirable.

If you’d prefer to generate a random value at note-on only:

1. Connect the **WHITE** or **PINK** output of the **NOISE GENERATOR** to the **SAMPLE & HOLD IN** jack.
2. Connect the **Switch** output to the **CLOCK** input.
3. Leave the **Switch AMS** source set to **Off**.

With the **AMS** source set to **Off**, it will automatically trigger the **CLOCK** at note-on, but not do anything else.

Of course, you can also route a real **AMS** source to the **CLOCK** input, and trigger it manually or via an **LFO**, **Step Sequencer**, etc.

For a more diffuse, “splatty” effect, try connecting **EG1 REV** to the **CLOCK** input.

## 6-1e: ENVELOPE GENERATORS 1 and 2

### EG outputs

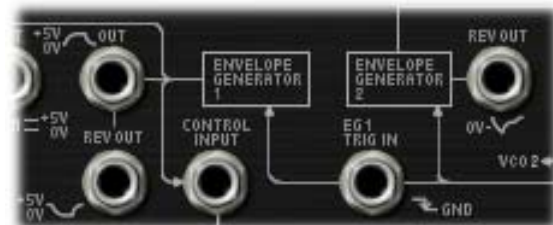

For descriptions of the EG parameters, see “5-1c: ENVELOPE GENERATOR 1” on page 304, and “5-1d: ENVELOPE GENERATOR 2” on page 304.

### EG 1 OUT jack

This allows you to route **EG 1** to another point on the Patch Panel.

Note that, when manually connected to the **VCO FREQ** input, this produces a different result than the normalised signal; for more information, see “EG1/EXT” on page 300.

### EG 1 REV OUT jack

This is the inverted shape of **EG 1**. The signal starts at the maximum value, falls to 0, and then releases back to the maximum value.

### EG 2 REV OUT jack

This is the inverted shape of **EG 2**. The signal starts at the maximum value, falls to 0, rises up to the sustain level, and then releases back to the maximum value.

### Trigger inputs



### TRIG IN jack

This lets you use an external trigger sources (such as the **MG** rectangle output, the trigger output of the **ESP**, or a switch controller via **AMS**) to trigger both **EG 1** and **EG 2**.

The EGs trigger when the **TRIG IN** moves from high to low, such as when the **MG** Rectangle wave switches to the bottom portion of the waveform. When the **TRIG IN** signal goes high again, the EGs enter their release phase.

Note that the **MG**’s **LED** is **on** when it is **low**. Initially, this seems like the opposite of what one might expect. When using the **MG** to trigger the EGs, however, this makes perfect sense: the EGs start when the **LED** goes on, and release when the **LED** goes off.

**EG 1 TRIG IN jack**

This is similar to the TRIG IN jack, above, but it triggers Envelope Generator 1 only.

**6-1f: Modulation VCA (MVCA)**

This is a second VCA, intended for scaling modulation signals.

For instance, to create a delayed vibrato:

1. Connect the MG triangle wave output to the MVCA input
2. Connect the MVCA output to the TOTAL input  
EG 1 is normalled to the CONTROL input, so without any additional connections, you can simply:
3. Adjust the EG 1 Delay and Attack controls to create the desired delay and fade-in times

**CONTROL INPUT jack**

This controls the level of the MVCA. It's normalled to the EG 1 output, but you can patch in any other control signal. This input includes built-in lowpass filtering, which acts as a smoother on the control signal.

**IN jack**

This is the input to the VCA. Unlike the CONTROL INPUT, this does not have any lowpass filtering.

**OUT jack**

This is the output of the VCA—the input signal scaled by the control signal.

**6-1g: NOISE GENERATOR**

These outputs provide pink and white noise, respectively. You can use these as sound sources or as modulation signals.

**PINK output jack**

Pink noise has a darker sound than white noise, with reduced high frequency components.

**WHITE output jack**

White noise is classic broad-band noise.

Note that white noise is also available as a waveform in VCO 1.

**6-1h: Mod Wheel and Mod Switch**

The Mod Wheel and Switch jacks allow you to select any AMS source (controllers, EGs, LFOs, step sequencer etc.), scale it via Intensity, and then route the signal into the patch panel.

For more information, see “Mod Wheel and Mod Switch” on page 316.

**(Mod Wheel) jack**

This lets you select, scale, and route the first AMS signal. This could be the Mod Wheel, if you wish—but it could also be any other AMS source.

**(Mod Switch) jack**

This lets you select, scale, and route the second AMS signal. You can use any AMS source, including continuous sources such as LFOs and EGs; the selection is not limited to on/off switches.

**6-1i: Keyboard Trigger and CV outputs****KBD CV OUT jack**

This allows you to route the keyboard's control voltage (which is a signal representing the current note) to other parts of the synthesizer.

**KBD TRIG OUT jack**

Whenever you play a key on the keyboard, a trigger signal is generated.

Using the Parameter Details box, you can select whether this trigger represents **Note Gate + Sustain**, or **Note Gate** only.

**Note Gate + Sustain** is the default, and is most appropriate for general use.

**Note Gate** is useful for keyboard trigger operation within self-triggering patches. For more information, see “Tip: Creating self-triggering patches” on page 309.



## 6-1j: MIXERS 1 and 2



### MIXER 1

This is a simple 2-in, 1-out mixer; you can use it for merging and scaling either control or audio signals. Note that you can also use this to invert the polarity of a signal.

The levels of inputs A and B are controlled by knobs on the MG, EGs, and Modulation page, and can be modulated via AMS; for more information, see “5-1g: Mixers” on page 306.

#### IN A jack

This is the first input to the mixer.

#### IN B jack

This is the second input to the mixer.

#### OUT jack

This is the merged output of IN A and IN B.

### MIXER 2

This is a second 2-in, 1-out mixer, identical to “MIXER 1,” above.

#### IN A jack

This is the first input to the mixer.

#### IN B jack

This is the second input to the mixer.

#### OUT jack

This is the merged output of IN A and IN B.

## 6-1k: EXTERNAL SIGNAL PROCESSOR (ESP)

### **Important: the ESP is only active when notes are played**

The ESP can process live audio inputs, feedback from effects, or any other audio from within the KRONOS—as well as audio from within the MS-20EX itself. Note, however, that the ESP is only active when a voice is being played on the MS-20EX.

It’s easy to make a patch in which only the incoming audio is heard, with the built-in VCOs completely silent—but you still need to press a key (or play a note via MIDI) in order to activate the MS-20EX. You can use the EXi Common **Hold** parameter to keep the note “held down” indefinitely, if you like.

For more information, see “Using the External Signal Processor (ESP)” on page 315, and “Tip: Creating self-triggering patches” on page 309.

### Audio Inputs



### EXi AUDIO IN jack

This mono input lets you route audio from elsewhere in KRONOS through the MS-20EX. You can use any of the audio inputs, any of the audio outputs, the REC buses, the FX Control buses, or the outputs of any of the Insert, Master, or Total Effects.

You can also route live or recorded audio through the MS-20EX, in real-time—and we’re sure that you’ll be able to think of other creative uses!

The audio input source and channel (left, right, or L+R summation) are selected by the Input Source and Channel parameters in the current Program, Combination Timbre, or Song Track.

For more information, see “4-2: EXi Audio Input” on page 174 (Program mode), “2-6: EXi Audio Input” on page 461 (Combination mode), and “2-6: EXi Audio Input” on page 573 (Sequencer mode).

Once you’ve selected the desired audio source, you can connect the EXi AUDIO IN jack to any input on the Patch Panel. For instance, you can route the audio through the HPF, LPF, or BPF, mix it with the built-in VCOs and noise generator, and so on. You can also use the ESP to convert the audio to a trigger or CV source, as described under “Using the External Signal Processor (ESP),” on page 315.

The EXi AUDIO IN is monophonic, but you can use two MS-20EX together to process stereo signals:

1. Create a double EXi Program, and assign both EXi1 and EXi2 to use the MS-20EX.
2. In the EXi Audio Input parameters, assign the left channel to EXi1, and the right channel to EXi2.
3. Pan the output of EXi1 to the left, and the output of EXi2 to the right.

**NOTE:** In the Legacy MS-20 plug-in, the audio input is normalled to the HPF’s Ext Signal Input. To enable more flexibility in patching, this signal is *not* normalled in the MS-20EX. When converting sounds from the Legacy plug-in, the EXi audio input should be patched to the Ext Signal In jack.

**SIGNAL IN jack**

This is the input to the External Signal Processor. To use this with live audio input, connect the EXi AUDIO IN jack to the SIGNAL IN jack.

**SIGNAL LEVEL knob** [0.00...10.00]

This adjusts the volume of the signal connected to the SIGNAL IN jack.

This knob has over 50dB of gain at the maximum setting of 10.00. Unity gain (+0dB) is at 3.75; 5.00 is about +4dB, and 7.50 is about +12dB.

If the input level is high, setting above unity gain will cause increasing amounts of saturation and overdrive, creating a more aggressive tone.

**(SIGNAL) OUT jack**

This is the signal from the SIGNAL IN jack, scaled by the SIGNAL LEVEL control.

**BAND PASS FILTER**

The Bandpass filter includes separate controls for high and low cut, and passes through only the audio between those two frequencies. It's normalised to the input of the Frequency-to-Voltage converter, for fine-tuning the incoming audio.

You can also use this filter to process audio signals, or to sculpt the Noise Generator's output for particular modulation effects. You can even use it as a third filter for the VCOs, in addition to the HPF and LPF.

**Note:** Even at the widest settings for high and low cut, there will still be some attenuation of the highest and lowest frequencies.

**(BAND PASS FILTER) IN jack**

This Patch Panel modification provides a direct input to the Bandpass filter. This means that you can use the filter separately from the Envelope Follower, if desired.

**LOW CUT FREQ knob** [0.00...10.00]

This knob adjusts the low-cut frequency of the Bandpass filter. Only frequencies **higher** than this will pass through the filter.

**HIGH CUT FREQ knob** [0.00...10.00]

This knob adjusts the high-cut frequency of the Bandpass filter. Only frequencies **lower** than this will pass through the filter.

**(BAND PASS FILTER) OUT jack**

This is the output of the Bandpass filter.

**Frequency-to-Voltage (F×V) CONVERTER**

This converter generates a "control voltage" signal based on the pitch of the audio input, which you can then use to control the pitch of the VCOs.

**CV ADJUST knob** [0.00...10.00]

Adjust this so that the input signal and the synthesizer's output signal are the same pitch. For more information, see "Using the External Signal Processor (ESP)" on page 315.

**F×V CV OUT jack**

This is the output of the F-V CONVERTER. You can connect this to the VCO 1+2 CV IN or VCO 2 CV IN jacks, to control the oscillator pitch.

**ENVELOPE FOLLOWER and TRIG OUT**

The ENVELOPE FOLLOWER creates a control signal out of the audio input level. For instance, you could connect the ENV OUT to the LPF CUTOFF FREQ input, to create an auto-wah filter.

The ENVELOPE FOLLOWER takes its input from the volume-scaled SIGNAL IN, right after the SIGNAL LEVEL knob.

Similarly, the TRIG OUT creates a trigger signal from the input. Use the THRESHOLD knob to set the volume level at which the trigger occurs.

**PEAK LED** [Off, On]

This LED shows that the ENVELOPE FOLLOWER is at its peak value. You can use this as an aid when adjusting the input signal's level and/or frequency content for optimal performance.

**ENV OUT jack**

This is the output of the ENVELOPE FOLLOWER. Connect this to any modulation input.

**THRESHOLD knob** [0.00...10.00]

This sets the volume level at which the trigger occurs. Adjust this to match the

**TRIG OUT jack**

This is the trigger generated from the audio signal. You can connect this to the EG 1&2 TRIG IN jack, the EG1 TRIG IN jack, or the SAMPLE & HOLD CLOCK input.

**TRIG OUT LED** [Off, On]

This LED shows that input signal is over the trigger THRESHOLD, and that the trigger output is on. You can use this as an aid when adjusting the

**THRESHOLD**, **LOW CUT FREQ** and **HIGH CUT FREQ** controls, or when using other controls to modify the input signal.

### Using the External Signal Processor (ESP)

You can use the ESP to control the MS-20EX from an external monophonic audio source, such as a melody played on a guitar. Just like the original MS-20, the MS-20EX will trigger its EGs and track the pitch of the guitar—with varying degrees of accuracy. Of course, the unpredictability is part of the charm...

Note that this will only work with single-note input, such as melodies; polyphonic input will not work properly.

You can also use the ESP as a modulation source when processing audio signals through the MS-20EX. This can be very useful with drums, for instance; you can use the input signal to trigger EGs, use the ESP's envelope follower to modulate the filters, and so on.

**Important:** the ESP only works if an MS-20EX note is being played! You can use the Hold parameter, or a damper pedal, to sustain a single note indefinitely if desired.

To set up the ESP for external control:

1. If you are using a live input, connect the instrument or microphone to the KRONOS audio inputs, and set up the gain accordingly.
2. On the EXi Audio Input page, select the desired input.

For more information, see “4-2: EXi Audio Input” on page 174 (Program mode), “2-6: EXi Audio Input” on page 461 (Combination mode), and “2-6: EXi Audio Input” on page 573 (Sequencer mode).

3. On the Patch Panel, connect the EXi AUDIO INPUT to the SIGNAL IN.
4. Play a note on the keyboard, or via MIDI. Use either the damper pedal or the HOLD parameter to keep the note sustained.

The ESP is only active when a note is being played.

5. Increase the THRESHOLD while watching the TRIG OUT light, until it lights when playing at medium to high volumes.

The light shows when the signal is over the trigger threshold.

6. Connect the ESP's TRIG OUT jack to the TRIG IN jack.

This makes EG1 and EG2 respond to the ESP's trigger output, instead of the keyboard.

7. Connect the ENV OUT jack to the VCA's INITIAL GAIN jack.

This makes the VCA level follow the amplitude of the ESP's signal, as generated by the envelope follower.

8. Connect the F×V CV OUT jack to the VCO 1+2 CV IN jack (or the VCO 2 CV IN jack).

This makes the pitch of the VCOs follow the pitch of the ESP's signal.

9. In the BAND PASS FILTER, set the LOW CUT FREQ to 10.00 and HIGH CUT FREQ to 0.00.

10. Play the highest note the ESP is to pick up, and slowly increase the HIGH CUT until the desired pitch is picked up.

11. Play the lowest note and slowly decrease the LOW CUT until the note is picked up.

These measures help to refine the CV converter's response to the input signal.

12. Set the CV ADJUST control so that the pitch matches that of the input instrument.

The MS-20EX should now respond to the audio input, as if you were playing on the keyboard.

## 6-1I: Parameter Details

The parameter details box shows different information depending on whether the current selection is an input or output jack, a knob, or one of the two assignable mod sources (the wheel and switch).

### Input and Output Jacks

If a jack is selected, this area shows the name of the selected jack on the top line, and the jack(s) to which it is connected on the bottom line, to the right of the arrow. If nothing is connected to the jack, the bottom line reads “(No Connection).”

If the selected jack is an output connected to multiple inputs, only the first connection is shown, followed by an ellipsis.



### Disconnect button

Pressing the **Disconnect** button clears all cables connected to the jack.

**Mod Wheel and Mod Switch**

In addition to the functionality described under “Input and Output Jacks,” above, these jacks allow you to select any AMS source, use Intensity to scale the signal, and then route it into the patch panel.

Note that the Mod Switch can use any AMS source, including continuous sources such as LFOs and EGs; it is not limited to on/off switches.



**AMS [List of AMS Sources]**

This selects the modulation source to route into the patch panel. For a list of AMS sources, see “Alternate Modulation Source (AMS) List” on page 1091.

**Important:** on the original MS-20, the Mod Wheel was a bipolar modulation source—meaning that the center position produced no modulation, moving down from the center made the value lower, and moving up from the center made the value higher.

The MS-20EX has a number of bipolar modulation sources, including the LFOs, EGs 3-6, and the Common Step Sequencer. JS+Y (the equivalent of the Mod Wheel), on the other hand, is unipolar.

You can use an AMS Mixer to convert JS+Y into a bipolar signal, if you like. To do so:

1. On the AMS Mixer page, set the Mixer Type to Offset.
2. Select JS+Y as AMS A.
3. Set AMS A Offset to -99.
4. Set AMS A Amount to +199.

These settings shift JS+Y down and then double its range, creating a bipolar signal.

5. In the Patch Panel, set the Mod Wheel jack to use the AMS Mixer (instead of JS+Y).

The Mod Wheel jack will now carry the bipolar JS+Y signal.

**Int (Intensity) [range depends on parameter]**

This controls the depth and polarity of the AMS signal.

**KBD TRIG OUT jack**

In addition to the functionality described under “Input and Output Jacks,” above, this jack lets you select the trigger type, as below.

**Trigger On [Note Gate + Sustain, Note Gate]**

**Note Gate + Sustain** is the default, and is most appropriate for general use.

**Note Gate** is useful for keyboard trigger operation within self-triggering patches. For more information, see “Tip: Creating self-triggering patches” on page 309.

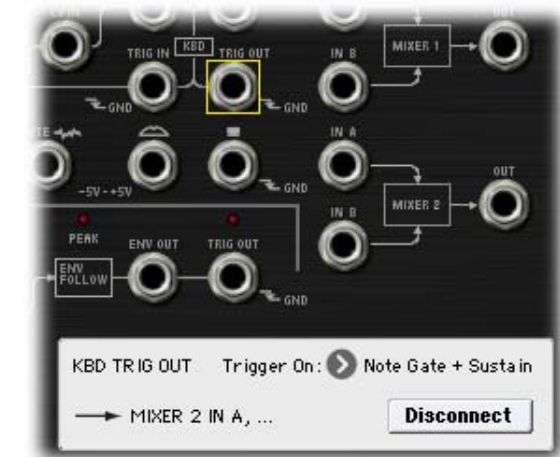

**Knobs**

If a knob is selected, this area shows its parameter group and parameter name, its exact value, and its AMS assignments. All six Patch Panel knobs, including Master Volume, are modulatable.



**(Parameter group)**

This shows the group of the parameter (such as VCO MIXER).

**(Parameter name) [range depends on parameter]**

This shows the name and exact value of the parameter. You can edit the parameter value with any of the standard data-entry controls.

**AMS [List of AMS Sources]**

This selects a modulation source to control the selected parameter. For a list of AMS sources, see “Alternate Modulation Source (AMS) List” on page 1091.

**Int (Intensity) [range depends on parameter]**

This controls the depth and direction of the AMS modulation.

### ▼ 6-1: Page Menu Commands

The number before each command shows its ENTER + number-key shortcut. For more information on these shortcuts, see “ENTER + 0-9: shortcuts for menu commands” on page 147.

- 0: **Write Program**. For more information, see “Write Program” on page 147.
- 1: **Exclusive Solo**. For more information, see “Exclusive Solo” on page 147.
- 2: **Delete All Connections**. For more information, see “Delete All Connections” on page 321.

## Program P7: EG 3-6

The MS-20EX has four assignable EGs, in addition to the original MS-20 EGs 1 and 2. Each of these can be used as an AMS modulation source to control a wide variety of parameters.

### 7-1: EG 3 AMSource

### 7-2: EG 4 AMSource

### 7-3: EG 5 AMSource

### 7-4: EG 6 AMSource

The MS-20EX’s EGs 3-6 are identical to the AL-1’s EG1. For detailed explanations, please see “7-1: EG 1 (Filter),” on page 211.

## Program P8: LFO 1-4

The MS-20EX has four assignable LFOs, in addition to the original MS-20 MG and the EXi Program’s Common LFO. Each of these can be used as an AMS modulation source to control a wide variety of parameters.

### 8-1: LFO 1 AMSource

### 8-2: LFO 2 AMSource

### 8-3: LFO 3 AMSource

### 8-4: LFO 4 AMSource

The MS-20EX’s LFOs 1-4 are identical to those of the AL-1. For detailed explanations, please see “8-2: LFO 1,” on page 217.

---

## Program P9: AMS Mixers

The AMS Mixers combine two AMS sources into one, or process an AMS source to make it into something new.

For instance, they can add two AMS sources together, or use one AMS source to scale the amount of another. You can also use them to modify the response of realtime controllers.

The AMS Mixer outputs appear in the list of AMS sources, just like other controllers.

This also means that the original, unmodified inputs to the AMS Mixers are still available as well. For instance, if you use Aftertouch as an input to a AMS Mixer, you can use the processed version of the Aftertouch to control one AMS destination, and the original version to control another.

Finally, you can cascade the AMS Mixers together—for instance, you can use AMS Mixer 1 as an input to AMS Mixer 2.

---

### 9-1: AMS Mixers 1-2

---

### 9-2: AMS Mixers 3-4

The MS-20EX's AMS Mixers are identical to those of the AL-1 (although the MS-20EX has four, to the AL-1's two). For detailed explanations, please see "9-1: AMS Mixer," on page 221.



## MS-20EX: Tone Adjust

MS-20EX Tone Adjust Default Settings

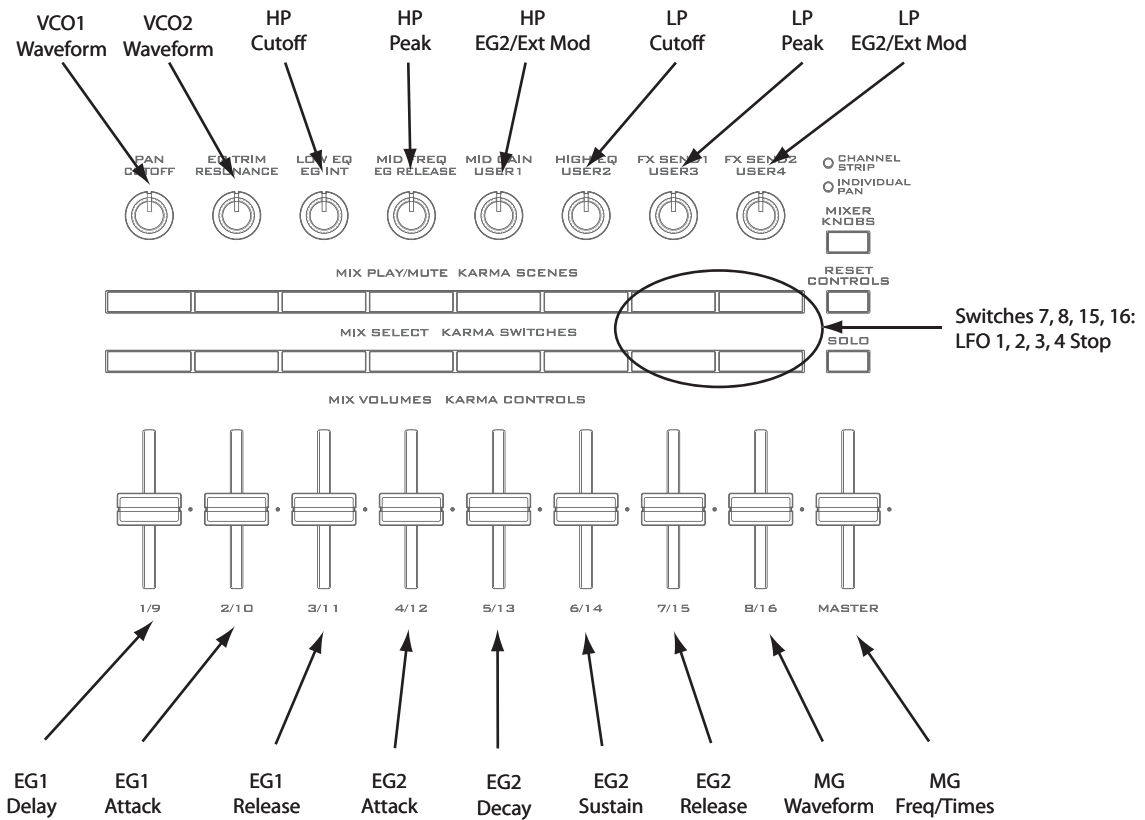

Tone Adjust provides an elegant physical interface to the MS-20EX's parameters. Most of the factory sounds use the default layout, as shown above. You can also customize the layout for individual sounds, if desired.

For more information about Tone Adjust, please see "0-9f: Tone Adjust," on page 30.

### Common Tone Adjust parameters

These parameters affect both EXi 1 and 2. Except as noted below, the Common Tone Adjust parameters behave as described under "Common Tone Adjust Parameters," on page 32.

**Filter Cutoff.** (-99...+99, CC#74)

This scales the cutoff frequency of the lowpass filter. To adjust the highpass filter, use the separate, MS-20EX-specific Tone Adjust parameters.

**Filter Resonance.** (-99...+99, CC#71)

This scales the resonance (**PEAK**) of the lowpass filter. To adjust the highpass filter, use the separate, MS-20EX-specific Tone Adjust parameters.

**Filter EG Intensity.** (-99...+99, CC#79)

This scales the **EG2/EXT** knob for the lowpass filter.

**Amp Velocity Intensity.** (-99...+99)

Not supported.

**Filter/Amp EG Attack Time.**

(-99...+99, CC#73)

This scales the attack time of EG2, which is normalised to both filter cutoff and amplitude.

**Filter/Amp EG Decay Time.**

(-99...+99, CC#75)

This scales the decay time of EG2. It interacts with CC# 75.

**Filter/Amp EG Sustain Level.**

(-99...+99, CC#70)

This scales the sustain level of EG2.

**Filter/Amp EG Release Time.**

(-99...+99, CC#72)

This scales the release time of EG2.

**Filter EG, Amp EG, and Pitch EG Attack Time, Decay Time, Sustain Level, Release Time** are not supported by the MS-20EX.

**Pitch LFO1 Intensity.** (-99...+99, CC#77)

This scales the **FREQUENCY MODULATION MG/T.TEXT** knob. (Note that this controls the amount of pitch modulation, but does not necessarily apply to LFO1.)

### MS-20EX Tone Adjust parameters

In addition to the Common Tone Adjust parameters listed above, the MS-20EX adds a number of its own parameters.

Note that these additional parameters are separate for each EXi, as opposed to being shared by both EXi in the Program.



All of the additional parameters are listed below. Tone Adjust parameters may affect the internal parameters in one of two ways: they may be **Relative**, in which case they scale the existing parameter value, or **Absolute**, in which case they over-write the existing value. Unless otherwise noted, all of the MS-20EX parameters are **Absolute**.

The full name of the currently selected parameter is shown in the status line at the top of the Control Surface page, as well as in the popup menu. Some parameters with longer names may show an abbreviation for the slider, knob, and switch labels.

### VCO1

VCO1 Wave Form

VCO1 PW

VCO1 Scale

### VCO2

VCO2 Wave Form

VCO2 Pitch

VCO2 Scale

### PORTAMENTO

Portamento Time

### FINE TUNE

Fine Tune

### FREQUENCY MODULATION

Freq Mod MG/T.Ext

Freq Mod EG1/Ext

### VCO Mixer

VCO 1 Level

VCO 2 Level

### HPF

HPF Frequency

HPF Peak

### CUTOFF FREQUENCY MODULATION (HPF)

HPF Mod MG/T.Ext

HPF Mod EG2/Ext

### LPF

LPF Frequency

LPF Peak

### CUTOFF FREQUENCY MODULATION (LPF)

LPF Mod MG/T.Ext

LPF Mod EG2/Ext

### PITCH

Bend Range

Transpose

### MODULATION GENERATOR (MG)

MG Key Sync

MG Tempo Sync

MG Base Note

MG Frequency

MG Times

MG Wave Form

### ENVELOPE GENERATOR 1

EG1 Delay Time

EG1 Attack Time

EG1 Release Time

### ENVELOPE GENERATOR 2

EG2 Hold Time

EG2 Attack Time

EG2 Decay Time

EG2 Sustain Level

EG2 Release Time

### MIXER 1

Mixer 1 Level A

Mixer 1 Level B

### MIXER 2

Mixer 2 Level A

Mixer 2 Level B

### EXTERNAL SIGNAL PROCESSOR

ESP Signal Level

ESP Low Cut Freq

ESP High Cut Freq

ESP CV Adjust

ESP Threshold

### EGs

The MS-20EX adds the following separate controls for EGs 3, 4, 5 and 6:

- Attack time (relative)
- Decay & Slope time (relative)
- Sustain level (relative)
- Release time (relative)

### LFOs

In addition to supporting the standard Tone Adjust LFO parameters, the MS-20EX adds the following separate controls:

- LFO 1, 2, 3, and 4 Waveform
- LFO 1, 2, 3, and 4 Shape
- LFO 3 Speed (relative)
- LFO 3 Fade (relative)
- LFO 3 Delay (relative)
- LFO 3 Stop
- LFO 4 Speed (relative)
- LFO 4 Fade (relative)
- LFO 4 Delay (relative)
- LFO 4 Stop

---

## MS-20EX: Page Menu Commands

---

### Delete All Connections

This command removes all of the connections from the Patch Panel, so that you can start from a blank slate.



# EXi: PolysixEX

## PolysixEX Overview

The PolysixEX is a rich-sounding, easy-to-use, high-polyphony virtual analog synth (up to 180 voices!). It combines the features and sonic character of the classic Korg Polysix (and the Legacy Polysix plug-in) with many additional capabilities unique to the KRONOS. Features include:

- Korg's proprietary CMT (Component Modeling Technology)
- Up to 180-voice polyphony
- Oscillator, sub-oscillator, and 4-pole resonant lowpass filter
- Dedicated chorus/ensemble/phaser effects
- Classic ADSR envelope, plus two multi-stage EGs
- Classic "MG" LFO, plus two multi-waveform LFOs
- Easy-to-use, sample-accurate arpeggiator
- Extensive AMS modulation, plus four AMS mixers

- Access to all standard EXi Program features, including the Common LFO, Common Step Sequencer, Key Track 1 & 2, KARMA, EQ, and effects—as well as layering with any other EXi (including using two PolysixEXs together!)

### PolysixEX uses EXi fixed resources

The PolysixEX uses EXi fixed resources for its built-in effects. These take up a small amount of processing power, even if you're not playing any notes.

Because of this, you can use only 16 PolysixEXs simultaneously in a Combination or Song. If other EXis with fixed resources are in use, the maximum number of PolysixEXs will be reduced accordingly. Each EXi in each Program counts towards the maximum; for instance, a Program with two PolysixEXs counts as two, not as one.

For more information, see "CX-3 & other EXi: Limitations on EXi fixed resources" on page 420.

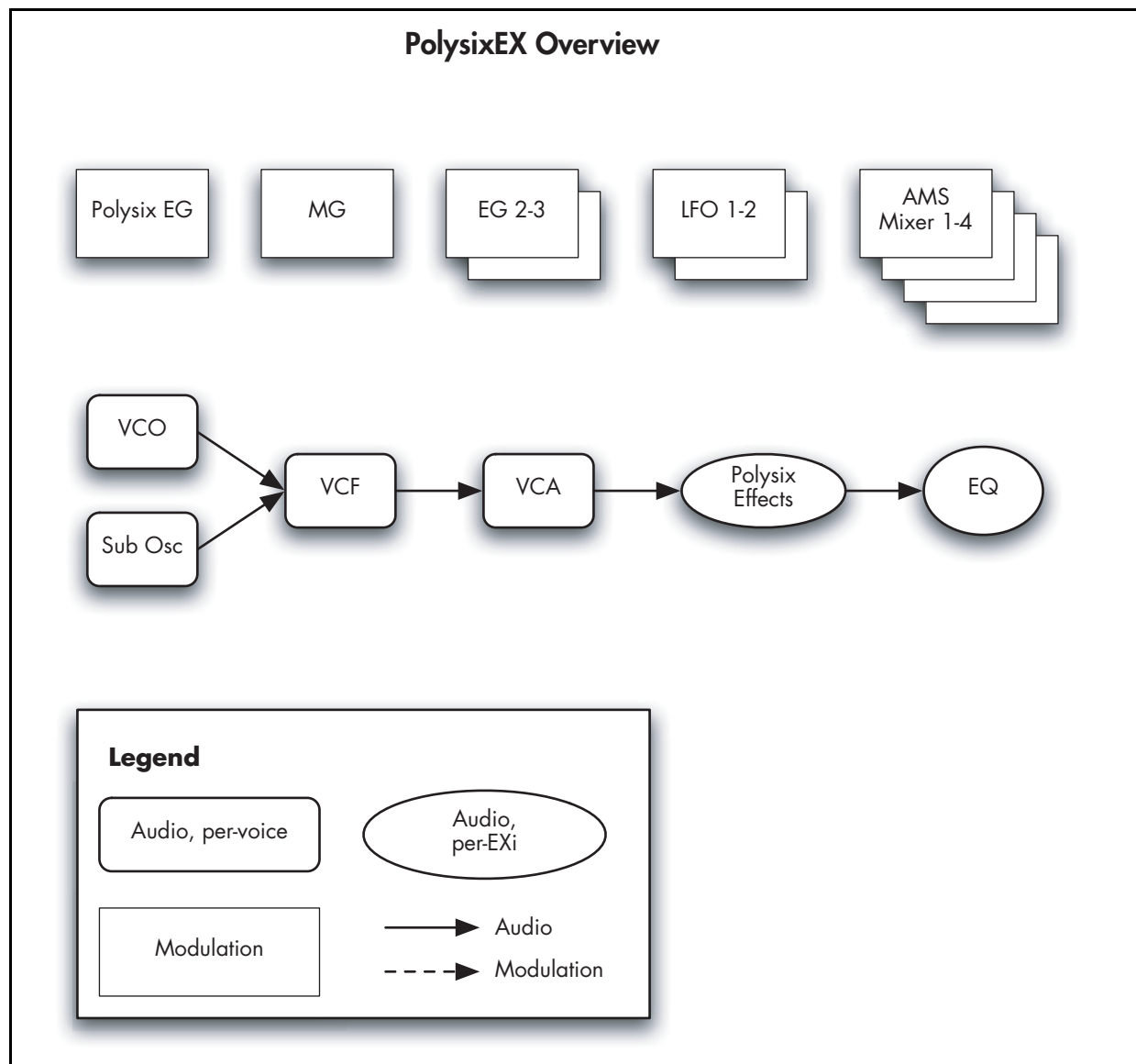

## Unsupported EXi Common parameters

The PolysixEX supports all of the EXi Common parameters, except for two of the voice allocation options: **Poly Legato** and **Mono Mode** (Normal/Use Legato Offset).

All of the other voice allocation options are fully supported, including Mono, Mono Legato, Unison, etc.

## On-screen knobs and switches and the Parameter Details area

### Parameter Details

The LCD displays include graphic knobs and switches for all of the main PolysixEX parameters. These let you view and edit parameters quickly and easily. Almost all of the original Polysix parameters fit onto a single KRONOS page.

You can program any original Polysix sound using only these knobs and switches. If you want more flexibility and control, however, the PolysixEX offers two additional EGs and LFOs, four AMS mixers, access to the EXi Program's Common LFO, Common Step Sequencer, and Vector features, and AMS modulation for almost every original Polysix parameter.

The entry way to these advanced features is the Parameter Details area, located in the lower right-hand part of the screen:

*Parameter Details area*

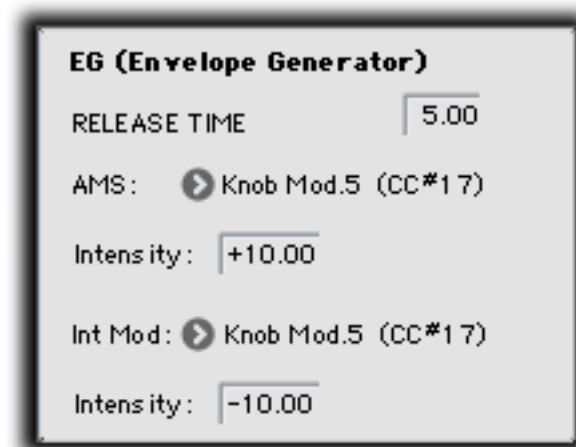

The Parameter Details area shows information for the selected knob or switch, including its parameter group and parameter name, its exact value, and its AMS assignments.

### Using the graphic parameters

#### Editing knobs and sliding switches

To edit knobs and sliding switches, such as the three-position **MG MODE** switch:

1. **Touch the knob or switch.**

A yellow square will appear around the knob or switch, showing that it has been selected. The Parameter Details area will change to show the name and value of the current parameter, along with other related information.

2. **Use any of the data-entry controls to edit the value.**

You can use the value slider, the inc/dec buttons, the rotary dial, or the numeric keypad.

As you edit the value, notice that the graphic knob or switch moves, and that the value in the Parameter Details area changes as well.

#### Editing on/off switches

To edit an on/off switch, such as the **MG KEY SYNC** button, simply:

1. **Touch the switch to toggle the value.**

### Assigning AMS modulation

Most parameters support modulation via AMS. Sources and intensities can be edited in the Parameter Details area:

1. **Touch the knob or switch.**

If the parameter supports AMS modulation, the Parameter Details area will show one or more AMS sources and intensities.

2. **Edit the AMS settings in the Parameter Details area.**

**Note:** the graphic knobs and switches always show their stored value. Absolute Tone Adjust settings edit these values, just as if you were editing the parameters themselves, and so the graphics will show the results. However, AMS modulation does not edit the stored value, and so the graphics do not include the results of AMS.

Note also that AMS can often modulate parameters outside the range of the stored values, as if you were pushing the parameter beyond the ends of the knob.

### Poly, Unison, Chord, and Hold

The original Polysix had four switches to select different voice-allocation options, including **POLY**, **UNISON** (mono), **CHORD**, and **HOLD**. In the KRONOS, all of these functions (and many more besides) are available on the Program Basic page.

## EXi Program P0: Play

### 0-1: Main



This is the main page of Program mode. For a full description of this page and all of its functions, please see “EXi Program P0: Play” on page 165. This section describes only the overview display, which differs for each individual EXi.

#### 0-1b: Overview and Page Jump

This part of the page shows an overview of the most important settings for the Program’s two EXi instruments. The specific parameters will vary, depending on which EXi are being used. The specific parameters for the PolysixEX are described below.

The graphics give you a quick way to check all of these settings at a glance. They also let you jump instantly to any of the displayed parameters. Just touch one of the sections, and you’ll jump to the page containing its parameters. For instance, if you touch the Filter graphic, you’ll go to the Oscillator and Filter page.

*Tip:* Pressing EXIT several times will always bring you back to this page.

#### VCO/VCF/EG/MG

This section shows the most important oscillator, filter, envelope, and modulation generator parameters. Touch this area to jump directly to the main PolysixEX page.

#### Arpeggiator

This section shows the arpeggiator parameters. Touch this area to jump directly to the Modulation & Arpeggiator page.

#### EGs and LFOs

##### EG 2,3 Graphics

These show the shapes of the two multi-stage EGs. Touch either of them to jump directly to the corresponding edit page.

##### LFO 1,2 Graphics

These show the waveforms and shapes of the two LFOs. Touch either of them to jump directly to the corresponding edit page.

#### Key Zone

##### Key Zone

This shows the key zones for EXi1 and EXi2, as set on the Common section’s Program Basic page, in relation to the entire MIDI note range. The range of the 61-, 73-, or 88-note keyboard is also shown, as appropriate.

Press this area to jump to the Program Basic page.

#### Common

The graphics along the right side of the screen show the most important Common parameters, which are shared by both EXi in the Program. This section will always show the same parameters, regardless of which EXi are being used.

#### Common Voice Assign Mode

This shows the voice assign mode of the Program—either POLY or MONO.

Press this area to jump to the Program Basic page.

**Common Step Sequencer**

This shows a graphic overview of the Common Step Sequencer.

Press this area to jump to the Common Step Sequencer page.

**Common LFO Graphic**

This shows the waveform of the Common LFO.

Press this area to jump to the Common LFO page.

**3 Band EQ Graphic**

This shows the mid-sweepable 3-band EQ.

Press this area to jump to the EQ page.

**IFX, MFX/TFX**

Press the IFX area to jump to the IFX Routing page.

Press the MFX/TFX area to jump to the MFX Routing page.

**KARMA GE Name**

This shows the name of the selected KARMA GE.

Press this area to jump to the GE Setup/Key Zones page.



# Program P4: Main

## 4-1: Main

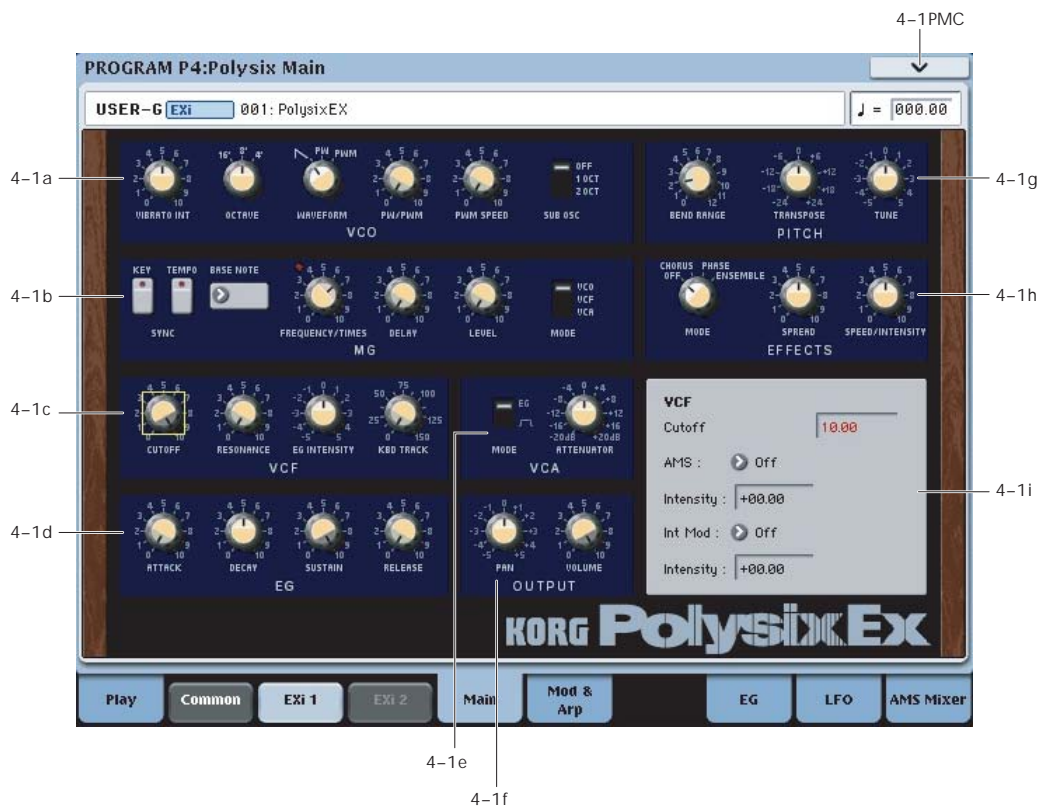

### 4-1a: VCO

#### VIBRATO INT [0.00...10.00]

Moving the joystick “up” from the center detent position, away from yourself, produces the JS+Y controller (MIDI CC#1). On the PolysixEX, JS+Y normally controls **VIBRATO**—the amount of the MG applied to VCO pitch.

**VIBRATO INT** controls the intensity of this modulation, up to +/- 2 semitones. To disable JS+Y’s control of **VIBRATO**, set this to **0.00**.

Note that this is optimized for fairly small amounts of pitch modulation. For more dramatic effects, set the MG’s **MODE** to **VCO**, and adjust the depth via the MG’s **LEVEL** knob.

Alternatively, you can modulate **TRANSPOSE** or **TUNE** via AMS.

**MIDI** **VIBRATO INT** is scaled by MIDI CC#77.

#### OCTAVE [16’, 8’, 4’]

This sets the VCO’s coarse tuning, in octaves.

#### WAVEFORM [SAW, PW, PWM]

This selects the VCO’s waveform.

**SAW** produces a sawtooth wave—the traditional buzzy analog synth sound.

**PW** produces square and pulse waveforms; for more information, see “PW/PWM,” below.

**PWM** is similar to **PW**, but uses a dedicated LFO to modulate the waveform. The speed of the LFO is controlled by “**PWM SPEED**,” below. The **PW/PWM** setting determines the maximum width.

#### PW/PWM [0.00...10.00]

When **WAVEFORM** is set to **PW**, this directly controls the shape of the waveform.

When **WAVEFORM** is set to **PWM**, this controls the maximum pulse width when being modulated by the dedicated PWM LFO. When **PW/PWM** is set to **0.00**, the LFO will have no effect.

#### More on Pulse Width

Pulse waveforms are simple, rectangular shapes. The Pulse Width sets the percentage of the waveform spent in the “up” position. A few examples are shown in the diagram below. Note that a square wave is just a pulse wave with **PW/PWM** set to **0.00**.

The width controls the timbre of the oscillator, from pure and hollow at **0.00** (a square wave) to thin and reedy at higher settings.

At the maximum setting of **10.00**, the Pulse wave will be very quiet, since the “pulse” goes up and then down again almost instantly.

The real magic of the pulse wave comes when you modulate the width, using either **AMS** or the dedicated **PWM LFO**. With **AMS**, try using a medium-speed triangle LFO, or a sweeping **EG**.

## Pulse waveform at different widths

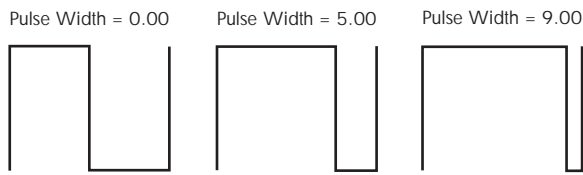
**PWM SPEED** [0.00...10.00]

The PolysixEX has an LFO dedicated to pulse width modulation (PWM). This adjusts the speed of that LFO. Note that this applies only when the **WAVEFORM** is set to **PWM**.

The dedicated PWM LFO is shared between all the PolysixEX voices, similar to the Common LFO.

If you'd like more flexible PWM, including per-voice modulation, you can use AMS to modulate the **PW/PWM** parameter directly.

**SUB OSC** [2OCT, 1OCT, OFF]

The VCO includes a sub-oscillator. You can set this to sound either one or two octaves below the main oscillator, or turn it off completely if desired.

**2OCT**: the sub-oscillator will sound at two octaves below the main oscillator.

**1OCT**: the sub-oscillator will sound at one octave below the main oscillator.

**OFF**: disables the sub-oscillator.

**4-1b: MG (Modulation Generator)** AMSource

The MG is shared between all PolysixEX voices, similar to the Common LFO. For per-voice modulation, use **LFO1** or **2** instead.

The MG is available as an AMS source throughout the PolysixEX, in two different versions: **MG** is the unaltered MG signal, and **MG + Delay** is at 0 until the programmed **DELAY** time has elapsed.

**TEMPO SYNC** [Off, On]

Touch the text/LED area to turn **TEMPO SYNC** on and off.

**On (LED lit)**: When **TEMPO SYNC** is **On**, the MG synchronizes to the system tempo, as set by either the Tempo knob or MIDI Clock. The MG speed is controlled by the combination of the **BASE NOTE** and **FREQUENCY/TIMES** parameters, below.

**Off (LED dark)**: When **TEMPO SYNC** is **Off**, the **FREQUENCY/TIMES** knob determines the speed of the MG, and the **BASE NOTE** setting has no effect.

This parameter is not modulatable via AMS.

**KEY SYNC** [Off, On]

If this setting is **ON**, the phase is reset for the first note-on in each legato phrase. Subsequent notes in a chord, or notes played legato, do not cause the phase to be reset.

This parameter is not modulatable via AMS.

**BASE NOTE** [1/1...1/32]

When **TEMPO SYNC** is **ON**, this sets the basic speed of the MG, relative to the system tempo. The values range from a 32nd note to a whole note, including triplets. This value is then multiplied by the **FREQUENCY/TIMES** knob, below.

When **TEMPO SYNC** is **OFF**, this parameter has no effect.

This parameter is not modulatable via AMS.

**FREQUENCY/TIMES** [0.00...10.00/16...1]

If **TEMPO SYNC** is **OFF**, this controls the frequency of the MG.

If **TEMPO SYNC** is **ON**, this multiplies the length of the **BASE NOTE**. For instance, if the **BASE NOTE** is set to a sixteenth note, and Times is set to 3, the MG will cycle over a dotted eighth note. Note that higher values mean a faster MG.

**DELAY** [0.00...10.00]

Adjusts the time from note-on until the MG is heard.

Note that this affects only the routing selected by the **MODE** parameter, below; the **VIBRATO** always uses the un-delayed MG signal.

**LEVEL** [0.00...10.00]

Adjusts the depth of the effect produced by the MG.

**MODE** [VCA, VCF, VCO]

Selects whether the MG modulates the amplitude (**VCA**), the filter cutoff (**VCF**), or the pitch (**VCO**).

**4-1c: VCF****CUTOFF** [0.00...10.00]

This controls the cutoff frequency of the 24dB lowpass filter. Sounds above this frequency are removed, making the timbre darker.

MIDI This is scaled by MIDI CC#74.

**RESONANCE** [0.00...10.00]

Resonance emphasizes the frequencies around the cutoff frequency.

When this is set to **0**, there is no emphasis, and frequencies beyond the cutoff will simply diminish smoothly.

At medium settings, the resonance will alter the timbre of the filter, making it sound more nasal, or more extreme.

At very high settings, the resonance can be heard as a separate, whistling pitch. Near the maximum setting, the filter will self-oscillate.

MIDI **RESONANCE** is scaled by MIDI CC#7.

**EG INTENSITY** [-5.00...+5.00]

Specifies the depth and direction to which the EG will affect the cutoff frequency.

MIDI This is scaled by MIDI CC#79.

**KBD TRACK [0.0...150.0]**

Adjusts the depth to which the cutoff frequency will change according to the note number, centered at C3.

With a setting of 100, the change in cutoff frequency will be proportionate to the change in pitch (1 octave in pitch = 1 octave in filter frequency).

**Note:** unlike some of the other EXi, the PolysixEX keyboard tracking does not include the effects of pitch bend. This matches the behavior of the original synthesizer. If desired, you can create the same effect by using JS X as an AMS source for the **VCF CUTOFF**.

**4-1d: EG**

EG

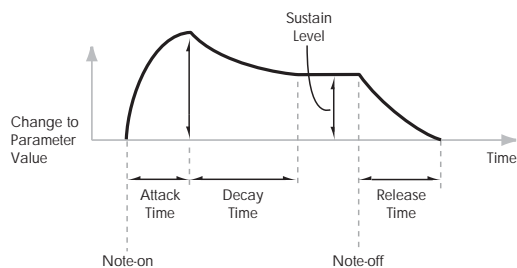

**ATTACK [0.00...10.00]**

Adjusts the time from note-on until the maximum level is reached.

**MIDI** This is scaled by MIDI CC# 73.

**DECAY [0.00...10.00]**

Adjusts the time the EG takes to descend from the peak to the sustain level.

**MIDI** This is scaled by MIDI CC# 75.

**SUSTAIN [0.00...10.00]**

Adjusts the sustain level. The EG will stay at this level until the note is released.

**MIDI** This is scaled by MIDI CC# 70.

**RELEASE [0.00...10.00]**

Adjusts the time from the note-off until the level decays to zero.

**MIDI** This is scaled by MIDI CC# 72.

**Using separate EGs for the VCF and VCA**

Unlike the original Polysix, the PolysixEX lets you use separate EGs for the VCF and the VCA. To do so:

1. Set the VCA MODE switch to EG.
2. Set the VCF EG INTENSITY to 0.00.
3. Select the CUTOFF parameter.
4. In the Parameter Details panel for CUTOFF, select EG2 as the AMS source.
5. Set the AMS Intensity as desired.

Now, the original EG will control the VCA, and EG2 will control the VCF.

**4-1e: VCA**

VCA stands for Voltage Controlled Amplifier, which is the circuit that controls the volume of an analog synthesizer.

**MODE [EG, Gate]**

This selects the main control source for the volume.

**EG** means that the volume is controlled by the ADSR envelope.

You can also use EGs 2 or 3 to modulate the main **VOLUME** parameter via AMS.

**Gate** means that the volume goes to maximum immediately at note-on, and falls to silence immediately at note-off.

**ATTENUATOR [-20.0...+20.0dB]**

Adjusts the volume up or down by 20dB, in 0.1 dB increments. This is separate from the main **VOLUME** knob, below.

Also, unlike **VOLUME**, the **ATTENUATOR** is per-voice, which means that you can modulate it via per-voice AMS sources such as EGs, LFOs 1 and 2, key tracking, etc.

**4-1f: OUTPUT**

**PAN [Random, L001...C064...R127]**

This controls the stereo pan of the PolysixEX, at the very end of the signal chain. A setting of **L001** places the sound at the far left, **C064** in the center, and **R127** to the far right.

When this is set to **Random**, the pan position will be different for each note-on.

You can also set this Pan parameter directly from the Control Surface knobs. To do so:

1. Press the Control Surface Timbre/Track button.
2. Set the MIXER KNOBS switch to INDIVIDUAL PAN.
3. Move Knob 1 to set the pan for EXi 1, and Knob 2 to set the pan for EXi 2.

**MIDI** You can also control pan via MIDI Pan (CC#10). A CC#10 value of 0 or 1 places the sound at the far left, 64 places the sound at the location specified by the "Pan" parameter, and 127 places the sound at the far right.

Note: you can select Random pan only from the on-screen UI, and not from AMS, MIDI or the Control Surface.

Note that this is a post-effects pan, while **Unison Stereo Spread** is pre-effects:

Pan via **Unison Stereo Spread** -> PolysixEX Effects (stereo) -> **PAN** knob (stereo in-out)

In the PolysixEX, **PAN** affects all voices at once, and so it cannot be modulated by per-voice AMS sources such as EGs or LFOs 1 and 2.

**VOLUME** [0.00...10.00]

This controls the main output level. It affects all voices at once, and so it cannot be modulated by per-voice AMS sources such as EGs or LFOs 1 and 2.

For per-voice modulation, use the **ATTENUATOR** parameter instead. For more information, see “ATTENUATOR” on page 329.

---

**4-1g: PITCH****BEND RANGE** [0.00...12.00]

This sets the maximum amount of pitch bend up and down, in semitones and cents, as controlled by JS X. To use another AMS source for pitch bend, modulate the **TRANSPOSE** or **TUNE** parameters instead.

**BEND RANGE** is not modulatable via AMS.

**TRANSPOSE** [-24.00...+24.00]

This controls the coarse tuning, in half-steps and cents, up or down two octaves. You can modulate this smoothly via AMS.

**TUNE** [-5.00...+5.00]

This adjusts the pitch of the oscillators, in steps of 1/5 of a cent, for a total range of +/- 1 semitone.

---

**4-1h: EFFECTS****MODE** [OFF, CHORUS, PHASE, ENSEMBLE]

Switches the effect mode. Choose from chorus, phase, and ensemble.

**SPREAD** [0.00...10.00]

Adjusts the width to which the effect sound will be panned.

**SPEED/INTENSITY** [0.00...10.00]

Adjusts the speed or intensity of the effect.

If **MODE** is set to **Chorus** or **Phase**, this adjusts the speed. If **Ensemble** is selected, this adjusts the depth.

---

**4-1i: Parameter Details**

When you touch a knob or switch, a yellow square appears around it, showing that it has been selected.

The Parameter Details area shows information for this selected item, including its parameter group and parameter name, its exact value, and its AMS assignments.

**Individual parameters and AMS**

**PITCH BEND RANGE** is not modulatable via AMS.

The **PAN** knob and a number of switches are modulatable by a single AMS source, as described under “Pan knob and Switches,” below. The rest of the continuous knobs on this page are modulatable via two AMS sources, as detailed under “Knobs,” below.

**(Parameter group)**

This shows the group of the parameter (such as **VCO**).

**(Parameter name) [range depends on parameter]**

This shows the name and exact value of the parameter. You can edit the parameter value with any of the standard data-entry controls.

**Knobs****AMS** [List of AMS Sources]

This selects a modulation source to control the selected parameter. For a list of AMS sources, see “Alternate Modulation Source (AMS) List” on page 1091.

**Intensity** [range depends on parameter]

This controls the depth and direction of the AMS modulation. For unipolar parameters, the range is the same as that of the selected parameter, in both positive and negative directions. For instance, if the parameter range is 0.00...10.00, the Intensity range will be -10.00...+10.00.

For bipolar parameters, including **FILTER EG INTENSITY**, **VCA ATTENUATOR**, **TRANSPOSE**, and **TUNE**, the range is twice that of the original parameter. For instance, if the original parameter range is -24.00...+24.00, the Intensity range will be double that: -48.00...+48.00. This allows full modulation of the parameter, regardless of the initial setting.

In some cases, you can use this to modulate the parameter outside of its original range, for a wider range of values.

**Int Mod** [List of AMS Sources]

You can modulate the main AMS Intensity from another AMS source. This selects that source. For a list of AMS sources, see “Alternate Modulation Source (AMS) List” on page 1091.

**Intensity** [range depends on parameter]

This controls the depth and direction of the Intensity Mod. The result is summed with the main AMS Intensity to produce the final modulation amount.

**Pan knob and Switches**

The **PAN** knob and the **OCTAVE**, **WAVEFORM**, **SUB OSC**, **VCA MODE**, **MG MODE**, and **EFFECTS MODE** switches can each be modulated from a single AMS source.

**TEMPO SYNC**, **KEY SYNC**, and **BASE NOTE** are not modulatable.

**AMS** [List of AMS Sources]

This selects a modulation source to control the selected parameter. For a list of AMS sources, see “Alternate Modulation Source (AMS) List” on page 1091.

**Intensity** [range depends on parameter]

This controls the depth and direction of the AMS modulation. The range is the same as the selected parameter, in both positive and negative directions.

---

**▼ 4-1: Page Menu Commands**

The number before each command shows its **ENTER** + number-key shortcut. For more information on these shortcuts, see “ENTER + 0-9: shortcuts for menu commands” on page 147.

- 0: **Write Program.** For more information, see “Write Program” on page 147.
- 1: **Exclusive Solo.** For more information, see “Exclusive Solo” on page 147.

# Program P5: Modulation & Arpeggiator

## 5-1: Modulation & Arpeggiator



### 5-1a: EXTERNAL MODULATION

The External Modulation section offers an easy way to assign modulation to multiple destinations at once, using any AMS source. Note that most parameters also include dedicated AMS modulation, via the Parameter Details area.

#### Source 1

#### SOURCE 1 [List of AMS Sources]

This selects the modulation source to control the parameters below. For a list of AMS sources, see “Alternate Modulation Source (AMS) List” on page 1091.

#### VCO PULSE WIDTH [-10.00...+10.00]

Specifies the depth and direction of the modulation applied to the oscillator (VCO) PW/PWM.

#### VCF CUTOFF [-10.00...+10.00]

Specifies the depth and direction of the modulation applied to the filter (VCF) CUTOFF.

#### VCA GAIN [-10.00...+10.00]

Specifies the depth and direction of the modulation applied to the amp (VCA).

#### MG LEVEL [-10.00...+10.00]

Specifies the depth and direction of the modulation applied to the MG (Modulation Generator) LEVEL.

### Source 2

This allows you to route a second AMS source to the same list of mod destinations. The parameters are identical to those under “Source 1,” above.

### 5-1b: ARPEGGIATOR

#### ON/OFF [Off, On]

Switches the arpeggiator on/off.

#### KEY SYNC [Off, On]

If this setting is ON, the arpeggiator will be reset at the beginning of each legato phrase.

This parameter is not modulatable.

#### TEMPO SYNC [Off, On]

Touch the text/LED area to turn TEMPO SYNC on and off.

**On (LED lit):** When TEMPO SYNC is On, the arpeggiator synchronizes to the system tempo, as set by either the Tempo knob or MIDI Clock. The arpeggiator speed is controlled by the combination of the BASE NOTE and SPEED/TIMES parameters, below.

**Off (LED dark):** When TEMPO SYNC is Off, the FREQUENCY/TIMES knob determines the speed of the arpeggiator, and the BASE NOTE setting has no effect.

This parameter is not modulatable via AMS.



**BASE NOTE** [1/1...1/32]

When **TEMPO SYNC** is **ON**, this sets the basic speed of the arpeggiator, relative to the system tempo. The values range from a 32nd note to a whole note, including triplets. This value is then multiplied by the **SPEED/TIMES** knob, below.

When **TEMPO SYNC** is **OFF**, this parameter has no effect.

This parameter is not modulatable via AMS.

**SPEED/TIMES** [0.00...10.00/16...1]

If **TEMPO SYNC** is **OFF**, this controls the speed of the arpeggiator.

If **TEMPO SYNC** is **ON**, this multiplies the length of the **BASE NOTE**. For instance, if the **BASE NOTE** is set to a sixteenth note, and **Times** is set to 3, each arpeggiator step will last for a dotted eighth note. Note that higher values mean a faster arpeggio.

**RANGE** [1OCT, 2OCT, FULL]

Specifies the range in which the arpeggiator will play the pattern. **FULL** plays the pattern over 6 octaves.

**MODE** [UP/DOWN, DOWN, UP]

Selects the pattern that the arpeggiator will play.

**LATCH** [Off, On]

Specifies whether the arpeggiator will continue playing even after note-off occurs.

**5-1c: ANALOG**

**ANALOG** [0.00...10.00]

This models the instability of an analog system by adding subtle randomization to the VCO and VCF frequencies.

This parameter is not modulatable.

**5-1d: Parameter Details**

This area shows details for the selected knob, including its parameter group and parameter name, its exact value, and its AMS assignments.

**Individual parameters and AMS**

Only the **ARPEGGIATOR** parameters are modulatable via AMS; the **EXTERNAL MODULATION** and **ANALOG** knobs, the **BASE NOTE** parameter, and the **TEMPO SYNC** and **KEY SYNC** switches are not modulatable.

Note that the **ARPEGGIATOR** affects all voices at once, and so it cannot be modulated by per-voice AMS sources such as EGs or LFOs 1 and 2.

**(Parameter group)**

This shows the group of the parameter (such as **ARPEGGIATOR**).

**(Parameter name) [range depends on parameter]**

This shows the name and exact value of the parameter. You can edit the parameter value with any of the standard data-entry controls.

**SPEED/TIMES knob**

**AMS** [List of AMS Sources]

This selects the first modulation source to control the selected parameter. For a list of AMS sources, see "Alternate Modulation Source (AMS) List" on page 1091.

**Intensity** [range depends on parameter]

This controls the depth and direction of the AMS modulation. The range is the same as the selected parameter, in both positive and negative directions. For instance, if the parameter range is 0.00...10.00, the Intensity range will be -10.00...+10.00.

**Int Mod** [List of AMS Sources]

You can modulate the main AMS Intensity from another AMS source. This selects that source.

For a list of AMS sources, see "Alternate Modulation Source (AMS) List" on page 1091.

**Intensity** [range depends on parameter]

This controls the depth and direction of the Intensity Mod. The result is summed with the main AMS Intensity to produce the final modulation amount.

**Multi-position Switches**

Multi-position switch parameters, including **RANGE** and **MODE**, have only a single AMS/Intensity pair, as below.

**AMS** [List of AMS Sources]

This selects a modulation source to control the selected parameter. For a list of AMS sources, see "Alternate Modulation Source (AMS) List" on page 1091.

**Intensity** [range depends on parameter]

This controls the depth and direction of the AMS modulation. The range is the same as the selected parameter, in both positive and negative directions.

**On/Off Switches**

On/off switch parameters, including **ARPEGGIATOR ON/OFF** and **LATCH**, have only a single AMS/Intensity pair, as below.

**AMS** [List of AMS Sources]

This selects a modulation source to control the selected parameter. For a list of AMS sources, see "Alternate Modulation Source (AMS) List" on page 1091.

**AMS Mode** [Toggle, Momentary]

This parameter controls the way in which the switch AMS works.

When this is set to **Toggle**, the switch will alternate between on and off. For instance, if **LATCH** is set to **Off**, and **AMS** is assigned to a footswitch, the first press will cause the arpeggiator latch to turn on, and the next press will turn it off again.

**Momentary** means that the switch value is changed only while the controller is enabled. Continuing the example from above, when the footswitch is pressed down, the arpeggiator latch will turn on; when the footswitch is released, the latch will turn it off again.



AMS lets you switch to the opposite of the programmed setting. For instance, if **LATCH** is set to **On**, and the **AMS Mode** is set to **Momentary**, then pressing down on the footswitch would cause the latch to turn off.

If you set AMS to use a continuous controller, such as the Joystick, values of 0-63 are as if the switch was off, and values of 64-127 are as if the switch was on.

Finally - note that the assignable switches, **SW1** and **SW2**, can themselves be set to either momentary or toggle modes, and these settings are reflected by the switch LEDs. Individual parameter mode settings, such as the **LATCH** AMS Mode, do *not* affect the LEDs.

So, if you're using SW1 or SW2 as the AMS source, it's best to set the AMS Mode to Momentary, and then just let the switch itself determine the momentary/toggle behavior.

---

### ▼ 5-1: Page Menu Commands

The number before each command shows its ENTER + number-key shortcut. For more information on these shortcuts, see "ENTER + 0-9: shortcuts for menu commands" on page 147.

- **0: Write Program.** For more information, see "Write Program" on page 147.
- **1: Exclusive Solo.** For more information, see "Exclusive Solo" on page 147.

---

## Program P7: EG 2-3

The PolysixEX has two assignable EGs, in addition to the original EG. Each of these can be used as an AMS modulation source to control a wide variety of parameters.

---

### 7-1: EG 2 AMSource

---

### 7-2: EG 3 AMSource

The PolysixEX's EGs 2 and 3 are identical to the AL-1's EG1. For detailed explanations, please see "7-1: EG 1 (Filter)," on page 211.

---

## Program P8: LFO 1-2

The PolysixEX has two assignable LFOs, in addition to the original Polysix MG and the EXi Program's Common LFO. Each of these can be used as an AMS modulation source to control a wide variety of parameters.

---

### 8-1: LFO 1 AMSource

---

### 8-2: LFO 2 AMSource

The PolysixEX's LFOs 1 and 2 are identical to those of the AL-1. For detailed explanations, please see "8-2: LFO 1," on page 217.

---

## Program P9: AMS Mixers

---

### 9-1: AMS Mixers 1-2 AMSource

---

### 9-2: AMS Mixers 3-4 AMSource

The PolysixEX's AMS Mixers are identical to those of the AL-1 (although the PolysixEX has four, to the AL-1's two). For detailed explanations, please see "9-1:

AMS Mixer," on page 221.

# PolysixEX: Tone Adjust

PolysixEX Tone Adjust Default Settings

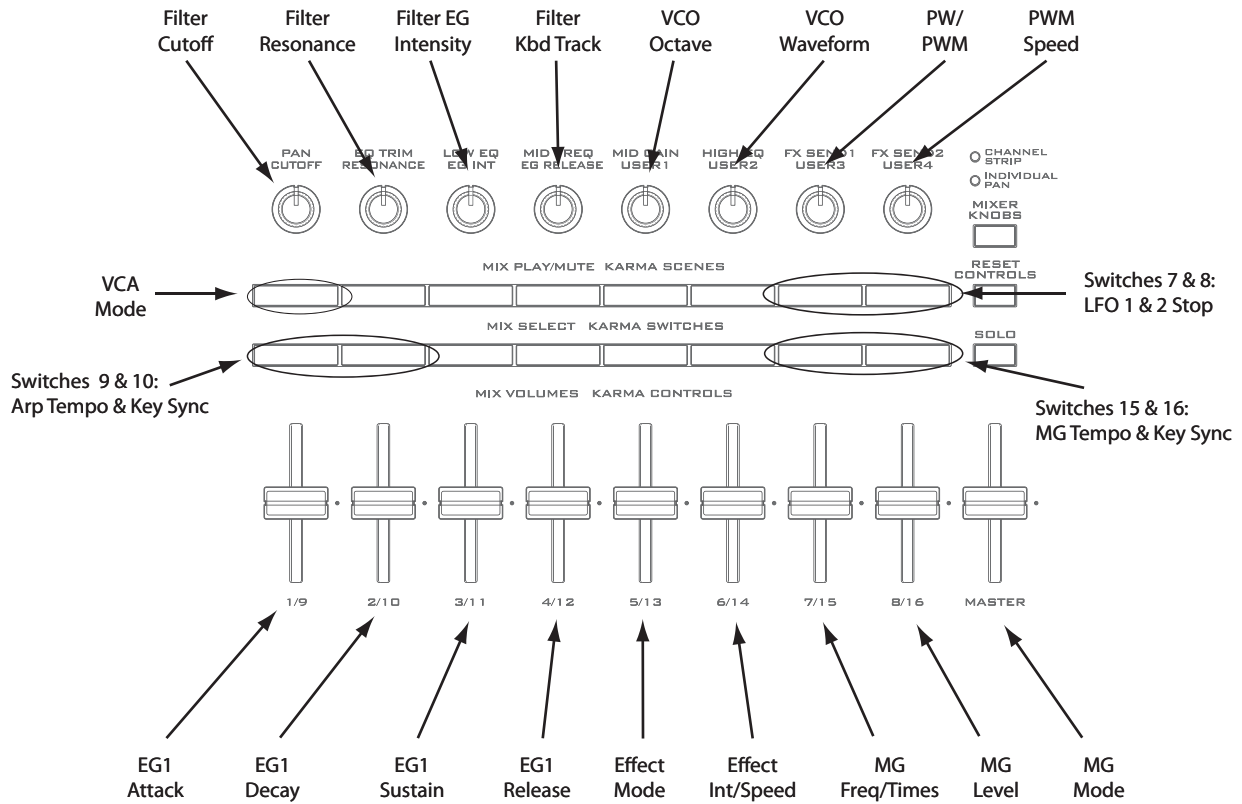

Tone Adjust provides an elegant physical interface to the PolysixEX's parameters. Most of the factory sounds use the default layout, as shown above. You can also customize the layout for individual sounds, if desired.

For more information about Tone Adjust, please see "0–9f: Tone Adjust," on page 30.

## Common Tone Adjust parameters

These parameters affect both EXi 1 and 2. Except as noted below, the Common Tone Adjust parameters behave as described under "Common Tone Adjust Parameters," on page 32.

**Amp Velocity Intensity.** (–99...+99)  
Not supported.

**Filter/Amp EG Attack Time.** (–99...+99, CC#73)  
This scales the attack time of the PolysixEX EG. It interacts with CC# 73.

**Filter/Amp EG Decay Time.** (–99...+99, CC#75)  
This scales the decay time of the PolysixEX EG. It interacts with CC# 75.

**Filter/Amp EG Sustain Level.** (–99...+99, CC#70)  
This scales the sustain level of the PolysixEX EG. It interacts with CC# 70.

**Filter/Amp EG Release Time.** (–99...+99, CC#72)  
This scales the release time of the PolysixEX EG. It interacts with CC# 72.

**Filter EG, Amp EG, and Pitch EG Attack Time, Decay Time, Sustain Level, Release Time** are not supported by the PolysixEX.

**Pitch LFO1 Intensity.** (–99...+99, CC#77)  
This scales the VIBRATO INT parameter.

## PolysixEX Tone Adjust parameters

In addition to the Common Tone Adjust parameters listed above, the PolysixEX adds a number of its own parameters.

Note that these additional parameters are separate for each EXi, as opposed to being shared by both EXi in the Program.

All of the additional parameters are listed below. Tone Adjust parameters may affect the internal parameters in one of two ways: they may be **Relative**, in which case they scale the existing parameter value, or **Absolute**, in which case they over-write the existing value. Unless otherwise noted, all of the PolysixEX parameters are **Absolute**.

The full name of the currently selected parameter is shown in the status line at the top of the Control Surface page, as well as in the popup menu. Some parameters with longer names may show an abbreviation for the slider, knob, and switch labels.

**VCO**

Vibrato Int  
Vibrato Int AMS Int  
VCO Octave  
VCO Waveform  
PW/PWM  
PW/PWM AMS Int  
PWM Speed  
PWM Speed AMS Int  
Sub Osc  
Sub Osc AMS Int

**VCF**

Filter Cutoff  
Filter Cutoff AMS Int  
Filter Resonance  
Filter Resonance AMS Int  
Filter EG Intensity  
Filter EG Intensity AMS Int  
Filter Keyboard Track

**VCA**

VCA Mode  
Attenuator  
Attenuator AMS Int

**EG**

EG Attack Time  
EG Attack Time AMS Int  
EG Decay Time  
EG Decay Time AMS Int  
Sustain Level  
Sustain Level AMS Int  
Release Time  
Release Time AMS Int

**OUTPUT**

Volume  
Volume AMS Int

**MODULATION GENERATOR (MG)**

MG Key Sync  
MG Tempo Sync  
MG Base Note  
MG Frequency  
MG Frequency AMS Int  
MG Sync Times  
MG Sync Times AMS Int  
MG Delay  
MG Level  
MG Level AMS Int  
MG Mode

**PITCH**

Transpose  
Transpose AMS Int  
Tune  
Tune AMS Int

**EFFECTS**

Effect Mode  
Effect Spread  
Effect Spread AMS Int  
Effect Speed/Intensity  
Effect Speed AMS Int

**ARPEGGIATOR**

Arpeg On/off  
Arpeg Key Sync  
Arpeg Tempo Sync  
Arpeg Base Note  
Arpeg Speed  
Arpeg Speed AMS Int  
Arpeg Times  
Arpeg Times AMS Int  
Arpeg Range  
Arpeg Mode  
Arpeg Latch

**EGs**

The following controls are available for both EG2 and EG3:

- Attack time (relative)
- Decay & Slope time (relative)
- Sustain level (relative)
- Release time (relative)

**LFOs**

In addition to supporting the standard Tone Adjust LFO parameters, the PolysixEX adds the following separate controls:

- LFO 1 and 2 Waveform
- LFO 1 and 2 Shape

# EXi: MOD-7 Waveshaping VPM Synthesizer

## MOD-7 Overview

The MOD-7 is a powerful, semi-modular synthesizer, combining Variable Phase Modulation (VPM), waveshaping, ring modulation, PCM sample playback, and subtractive synthesis. Exceptionally versatile, the MOD-7 produces everything from classic FM keyboards and bells to rhythmic soundscapes, from cut-through-the-mix synth basses to sparkling, epic pads.

VPM refers to Korg's patented contributions to Frequency Modulation (FM) synthesis; for more information, see "VPM and FM Synthesis" on page 341.

Features include:

- Six VPM Oscillators. Each can be used as a sine, saw, triangle, square, or waveshaping oscillator with FM and ring modulation, or as a waveshaping and/or ring mod processor for other signals.
- 101 different waveshaping tables, whose response can be controlled via modulatable drive and offset.
- A PCM sample playback oscillator using Korg's ultra-low-aliasing PCM technology, as first introduced in the HD-1. This supports four-way velocity-switching between any mono samples from ROM, EXs, Sampling Mode, or User Sample Banks.
- Dual multi-mode resonant filters (including Korg's Multi Filter, as first introduced in the AL-1).
- Three patchable, modulatable 2-in, 1-out mixers for combining and scaling audio signals.
- Noise generator with dedicated filter and saturation.
- Live audio input.
- Patch Panel allows free connection of all components, including the six VPM Oscillators, PCM oscillator, noise generator, real-time audio input, three modulatable mixers, and two filters. Connections can include multiple cables from a single output, hybrid serial/parallel routings, and feedback paths.
- "Vast" sample-mangling capabilities, with incredible flexibility and power. Use samples as FM modulators, and create incredibly rich processing environments combining multiple stages of filtering, waveshaping, and ring modulation, patched together however you'd like.
- Up to 52 voices of polyphony.
- Import classic FM sounds from the DX7.
- Four per-voice LFOs, ten re-triggerable EGs, nine key-tracking generators, eight AMS mixers, and a per-voice step sequencer.
- Access to all standard EXi Program features, including the Common LFO, Common Step Sequencer, Key Track 1 & 2, KARMA, EQ, and effects—as well as layering with any other EXi

(including two MOD-7s together, for 12 VPM oscillators!)

---

## MOD-7 uses EXi fixed resources

The MOD-7 uses EXi fixed resources for its audio input. This takes up a very small amount of processing power, even if you're not playing any notes on the keyboard. The amount is tiny—around 1/96 that of the CX-3—but if other EXi are using large amounts of fixed resources, the number of MOD-7 that you can load in a Combination or Song may be limited.

Each EXi in each Program counts towards the maximum; for instance, a Program with two MOD-7s counts as two, not as one.

For more information, see "CX-3 & other EXi: Limitations on EXi fixed resources" on page 420.

---

## Unsupported EXi Common parameters

The MOD-7 supports all of the EXi Common parameters, except for two of the voice allocation options: **Poly Legato** and **Mono Mode** (Normal/Use Legato Offset).

All of the other voice allocation options are fully supported, including Mono, Mono Legato, Unison, etc.

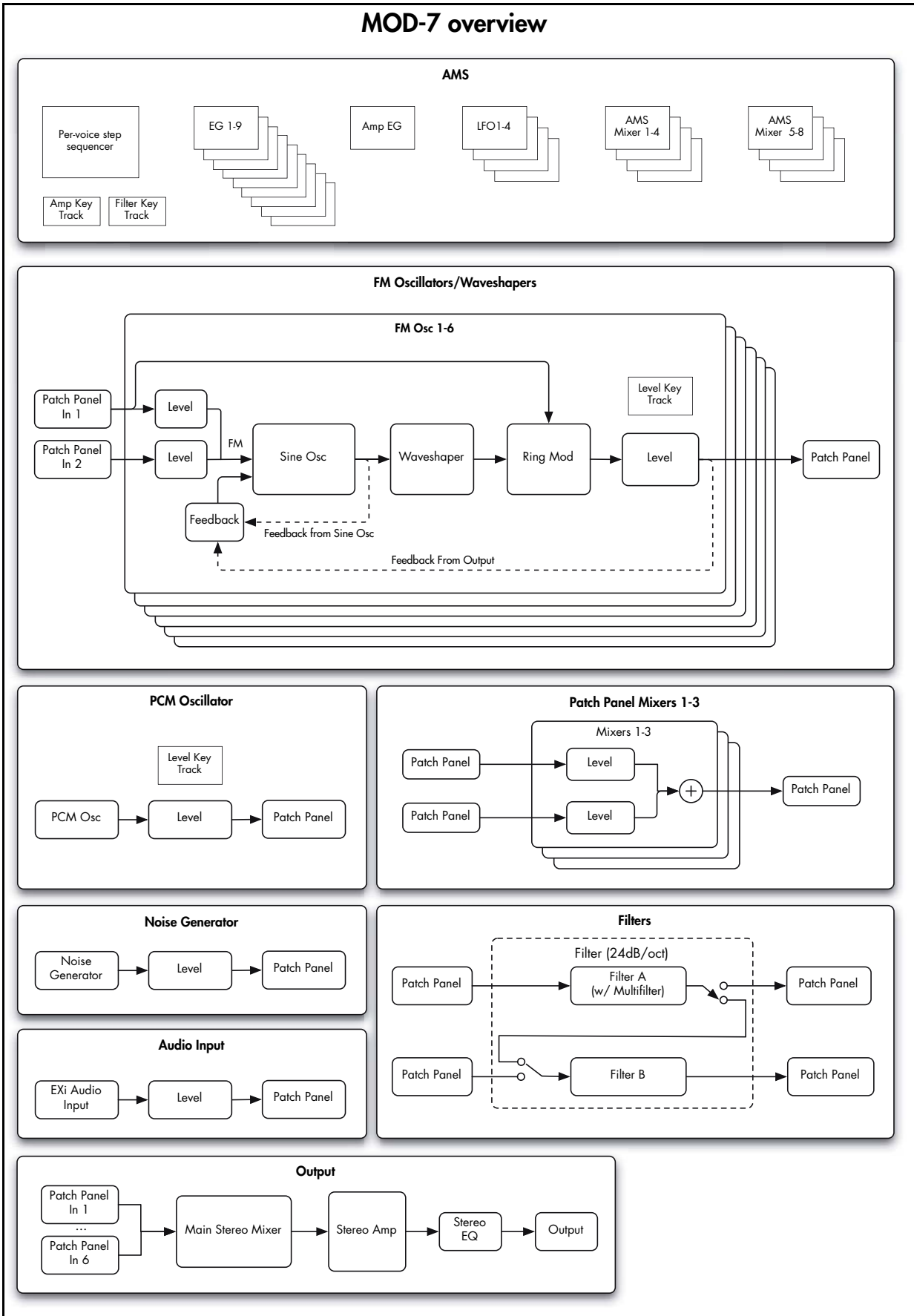

## Using the Parameter Details area

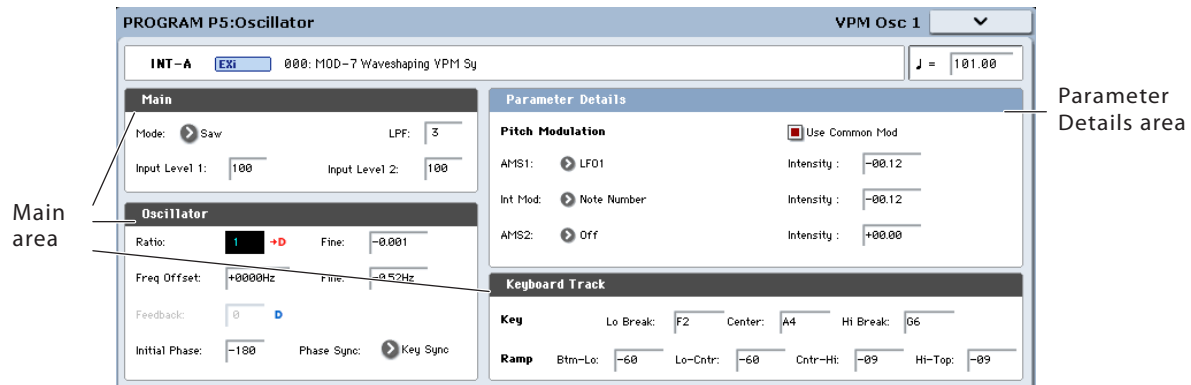

### Overview

The LCD displays are divided into two sections. The first is the main part of the display, which includes all of the major MOD-7 parameters. This provides quick access to different functions, and an easy-to-read overview of the current settings.

The other section is the Parameter Details area, located in the upper right-hand part of the screen. This area shows information for the selected parameter, such as descriptive graphics and AMS assignments.

### Assigning AMS modulation

Parameters which have AMS modulation shown only in the Parameter Details area are marked with either a blue "D" or a red "D" (for "Details") and an arrow. The

blue "D" indicates that the Parameter Details area includes the possibility of AMS modulation, but that none is assigned; the red "D" and arrow show that an AMS source is already assigned

To edit AMS settings in the Parameter Details area:

1. Touch the parameter in the main area of the display.

If the parameter supports AMS modulation, the Parameter Details area will show one or more AMS sources and intensities.

2. Edit the AMS settings in the Parameter Details area.

Note that AMS can often modulate parameters outside the range of the stored values, as if you were pushing the parameter beyond the ends of the knob.

## Loading DX sounds

### Overview

The MOD-7 can load sounds created for the vintage DX7. There are thousands of these sounds available on the internet, providing a massive pre-existing library of timbres (in addition to the many sounds created exclusively for the MOD-7!). Try searching for "DX7 SysEx download."

Once loaded, you can bring these vintage sounds up to date using all of the MOD-7's unique features, layer them with other EXi, and process them with KARMA and the KRONOS effects.

The conversion works by reading .SYX format System Exclusive files. This format is supported by programs on all major computer operating systems.

### Supported file types

In order to load a file, it must meet the following requirements:

- The file must contain a complete bank of 32 DX7 sounds. Files with only a single sound cannot be loaded.

- The file may contain multiple System Exclusive messages, but only if the main DX7 bank dump is the first of these messages. All subsequent messages in the file will be ignored.

**Note:** some instruments, such as the DX7II, may transmit multiple System Exclusive messages when doing their program data dump, with the main DX7 bank dump coming last. If this set of messages is stored into a single .SYX file, the KRONOS will not be able to load the file.

- The System Exclusive must be in the original, first-generation DX7 format, which was supported by all of the classic 6-operator FM synths as well as the DX9. System Exclusive files from later-generation FM instruments, such as 4-operator "baby DX" synths and the TX81Z, SY77, etc., cannot be loaded.

### Loading a single bank of DX7 sounds

To load a bank of DX7 sounds:

1. Transfer the DX7 .SYX file to KRONOS-readable media, such as a USB flash drive.
2. Connect the media to the KRONOS.

3. Press the front-panel DISK button to enter Disk mode.
4. Go to the Load page.
5. In the Drive Select parameter, select the media from step 2, above.
6. Select the DX7 .SYX file.
7. Press the LOAD button.

A dialog box will appear, allowing you to select a bank into which to load the sounds. Since DX7 banks contain 32 sounds, while a KRONOS bank contains 128, you can also select where to place the DX7 sounds within the KRONOS bank: into Programs 0-31, 32-63, 64-95, or 96-127.

8. Select the bank and Program range into which to load the sounds.

**Important:** If you select an HD-1 bank, it will be changed to an EXi bank, and all of the banks's HD-1 Programs will be erased.

9. Press OK to load the sounds.

The sounds will be loaded into the KRONOS as MOD-7 Programs.

---

### Loading multiple banks of DX7 sounds

If you like, you can load multiple .SYX files at once. To do so:

1. Follow steps 1 through 4 under "Loading a single bank of DX7 sounds," above.
  2. Enable the Multiple Select check-box.
  3. Select the desired DX7 .SYX files.
  4. Press the LOAD button.
- An "Are you sure?" dialog will appear.
5. Press OK.
  6. For each .SYX file, select the bank and Program range to load into.

For more information, see steps 8 and 9 under "Loading a single bank of DX7 sounds," above.

---

### Error messages

If the KRONOS can't read the file, it will show one of two error messages:

**There is no readable data** will appear if the file is shorter than 4104 bytes, or if the SysEx header indicates something other than DX7 Program Bank format.

**File contains unsupported data** will appear if the header is correct, but the data is damaged; for instance, if the file's checksum doesn't match, or if the trailing F7 is missing.

---

### Velocity response

Converted sounds will respond to MIDI velocity in the same way as did the original instruments. In other words, if you play both the original and converted sounds from an external MIDI controller, they should sound the same.

However, the local keyboards on some of the original DX instruments were not capable of producing very high velocities; instead, they might max out around 105 or so. The KRONOS's keyboard, on the other hand, can produce velocities over the full MIDI range, up to 127.

This means that some sounds may be brighter when played from the KRONOS's keyboard, as compared to the original instrument's keyboard. If you like, you can use the **Brightness Vel. Sens.** parameter to reduce the velocity sensitivity to taste. For more information, see "Brightness Vel. Sens." on page 358.



## Synthesis with the MOD-7: a guided tour

### Overview

The tutorials below provide a guided tour of the MOD-7's synthesis capabilities. They start with a little background information, and then dive right into step-by-step instructions for creating simple sounds from scratch, using all of the MOD-7's major features.

Please read each section in order, since the later ones rely on what you've done earlier.

### VPM and FM Synthesis

Variable Phase Modulation (VPM) synthesis refers to Korg's patented contributions to Frequency Modulation (FM) synthesis.

#### Carrier-modulator pairs

In its most basic form, these synthesis methods use a pair of oscillators: a modulator and a carrier. Only the carrier is connected to the audio output. The modulator is not heard directly; instead, its output modulates the frequency (or phase) of the carrier.

This modulation creates changes in timbre. The relative frequencies (or "ratios") of the two oscillators determines which overtones are produced, and the level of the modulator controls the loudness of those overtones.

In general, whole-number ratios produce harmonically related overtones, fine deviations from whole-number ratios produce similar overtones with chorusing, and more complex ratios produce wild, clangorous overtones.

#### Greater complexity

Most modern VPM and FM synths allow more than simple oscillator pairs. For instance, a modulator might itself be modulated, to create a more complex timbre; two modulators might have separate paths into a single carrier; a single modulator might be sent to two or more carriers; and so on. A carrier might both be heard directly, and also act as a modulator on another oscillator. Feedback paths may let a carrier modulate itself.

In the MOD-7, these routings are created on the Patch Panel, by selecting an algorithm, creating patch cables, or a combination of the two.

The more complex the routing and frequency relationships, the more difficult it can be for even experienced sound designers to predict the results. As legend has it, the main breakthrough for FM itself came from a mistake, when FM pioneer John Chowning programmed an LFO with a frequency 100 times faster than he'd intended. When working with the MOD-7, take a cue from his example: keep experimenting, and leave your ears open for "happy accidents."

### VPM, PCM, Waveshaping, and Ring Mod

The MOD-7 combines VPM with PCM sample playback, waveshaping, ring modulation, and dual multimode resonant filters. It's a powerful digital synthesis toolkit, and it can be approached from many different angles, as discussed in the tutorials below.

### More information on the internet

There have been entire books written about FM synthesis. While we'll look at many practical examples of FM in the tutorials below, more theoretical information is unfortunately outside the scope of this manual.

If you are curious to learn more, you can find a great deal of information on the internet, ranging from introductory articles to highly technical academic treatises. Try searching for "FM synthesis" or "frequency modulation synthesis."

### Aliasing

Multiplying one audio-rate signal with another generally causes aliasing, and VPM is no exception. Higher modulator levels can produce aliasing artifacts, from low-level grunge to phantom pitches to, at the extremes, loud white noise. This becomes more of an issue with higher frequencies, such as when playing in the top octaves of the keyboard.

Sometimes, these artifacts may be useful as part of the overall timbre; other times, they may be unwelcome guests. The most valuable tool to mitigate aliasing is Key Tracking, which lets you reduce the modulator levels at higher frequencies, while keeping them stronger at lower frequencies. The MOD-7 includes dedicated multi-point key tracking for each VPM Oscillator.

### Creating an initialized MOD-7 Program

For the tutorials below, we'll need to start with an initialized MOD-7 Program. To do this:

1. **In Program mode, select factory Program I-A 050, "Cat On aMoJo."**
2. **Press the Common button, to go to the EXi Common pages.**
3. **Press the Basic/Vector tab.**

The Basic/Vector pages will appear on the upper row of tabs.

4. **Press the Program Basic tab.**

Now, you should be on the Program Basic page.

5. **Change the EXi1 Instrument Type from CX-3 Tonewheel Organ to MOD-7 Waveshaping VPM Synthesizer.**

That's it; you now have an initialized MOD-7 Program, plus a bit of reverb for ear-candy. The Control Surface is also set to Tone Adjust, which we'll take advantage of throughout the tutorial.

If you've already been working with the MOD-7, and want to return to an initialized state:

1. Select the **EXi1 Instrument Type** parameter.
2. Use the **Dec ▾** button to change it to **PolysixEX**.
3. Use the **Inc △** button to toggle it back to **MOD-7**.

---

## Individual oscillators and subtractive synthesis

Each of the six VPM Oscillators can be used on its own, to generate sine, saw, triangle, or square waveforms, plus timbres created by waveshaping. You can layer multiple VPM Oscillators together, modulate their volumes, and process them through filters for standard subtractive synthesis.

---

### Layering six saw oscillators

Let's start by creating a simple sound with six layered sawtooth oscillators.

1. Follow the instructions under **"Creating an initialized MOD-7 Program,"** above.

2. Press the **EXi1** button.

The MOD-7's tabs will appear on the right.

3. Press the **Patch Panel** tab.

The Patch Panel will appear. This shows all of the basic building blocks of the MOD-7, including all of the oscillators, filters, mixers, and so on.

The Algorithm name is shown in the upper left-hand corner. By default, it's set to **Blank Patch**.

4. Open the **Algorithm pop-up**, and select **05: All carriers -> 4-pole**.

5. Press **OK** to confirm the selection and close the popup.

As a shortcut, you can also select the Algorithm name on the Patch Panel page, and then enter the Algorithm number from the numeric keypad.

Notice that the lines on the Patch Panel have changed. These show the normalled connections between the various blocks. ("Normalled" is a term used in patchbays and modular synths, meaning the default internal connections between patch points.)

**05 All carriers -> 4-pole** has outputs from all six VPM Oscillators mixed into a single filter.

The VPM Oscillators are shown as a line of six boxes, running from 1 at the top to 6 at the bottom. The boxes are labeled simply with the numbers 1 through 6. Each has two input jacks, colored red, and one output jack, colored blue.

6. Touch the **blue circle (the output)** on **VPM Oscillator 1**.

A yellow highlight box will appear around the output jack, to show that the jack is selected.

Look in the upper right-hand corner of the page. This is the Parameter Details area; it shows additional information about the selected item. In this case, it will show that you've selected the output of VPM Oscillator 1, along with the output level and the inputs to which it is connected (if any). It also has two buttons: **Jump** and **Disconnect**.

7. Press the **Jump** button.

This takes you to the selected block's page—in this case, the VPM Oscillator 1 page. You can use this shortcut with any of the blocks on the Patch Panel.

8. On the **VPM Oscillator 1** page, set the **Mode** to **Saw**.

This controls the basic timbre of the oscillator.

9. Set the **Ratio Fine** to **+0.004**.

This causes the pitch to be very slightly higher than nominal. We're going to detune all six oscillators, to create a fat, stacked sawtooth timbre.

10. Using the tabs, select each of the other VPM Oscillators in turn. For each one, set the **Mode** to **Saw**, and set the **Ratio Fine** as noted below.

- Osc 2: -0.004
- Osc 3: +0.008
- Osc 4: -0.008
- Osc 5: +0.014
- Osc 6: -0.014

Now, try playing the keyboard. It should sound like a thick, detuned sawtooth timbre, with a "digital" tone quality.

To warm it up a bit, let's make it so each oscillator starts with a random phase.

11. For each of the VPM Oscillators, set the **Phase Sync (in the Oscillator section)** to **Random**.

Notice how this makes the sound more full and rounded.

---

### Hands-on control with Tone Adjust

The default Tone Adjust settings give you hands-on control of the most important MOD-7 parameters. Notice that, to the Left of the Control Surface, the Tone Adjust button is lit. This means that the Control Surface knobs, sliders, and switches will control the Tone Adjust parameters.

Let's try this out, continuing from the above:

1. Use **Switches 1–6** to turn **VPM Oscillators 1-6 on and off**.
2. Use **Sliders 1–6** to adjust the volumes of **VPM Oscillators 1–6**.

In this sound, turning off or reducing the volume of the higher-numbered oscillators will reduce the timbre's "fatness."

3. While playing, turn **Knob 7 to the Left**.

By default, Knob 7 controls Filter A's cutoff, so turning it creates a filter sweep.

For a graphic showing all of the default Tone Adjust assignments, see “MOD-7: Tone Adjust” on page 385.

## VPM (aka FM)

### Basic VPM

To start using VPM in earnest, simply connect the output of one VPM Oscillator to the input of another. You can do this either by selecting an algorithm, or creating a patch cable. For instance:

1. Follow the instructions under “Creating an initialized MOD-7 Program,” above.
2. Press the EXi1 button, and then press the Patch Panel tab.

The Patch Panel will appear.

3. Set the Algorithm to 08: 2 + 2 + 2 -> Parallel Filters.

This groups the six VPM Oscillators into three carrier-modulator pairs.

4. On the Control Surface, press switches 3 through 6, so that their LEDs turn off.

This mutes VPM Oscillators 3–6. We’ll only be working with Oscillators 1 and 2.

5. Lower Slider 1 to the bottom of its range, and play the keyboard.

Lowering Slider 1 turns VPM Oscillator 1’s volume all the way down. This means that you’ll hear only VPM Oscillator 2, which plays a pure sine wave.

6. While playing the keyboard, slowly raise Slider 1 to the middle of its range, or slightly higher.

As you raise Slider 1, listen to how the timbre changes to be increasingly bright. What you’re hearing is FM synthesis: VPM Oscillator 1 is modulating VPM Oscillator 2. By controlling the level of VPM Oscillator 1, Slider 1 controls the amount of modulation.

In this algorithm, using standard FM terms, VPM Oscillator 1 is a modulator, and VPM Oscillator 2 is a carrier.

7. While playing the keyboard, very slowly rotate Knob 1.

Knob 1 controls the Ratio, or fundamental pitch, of VPM Oscillator 1. Since VPM Oscillator 1 is acting as a modulator, this changes the timbre of the sound.

8. Experiment with different settings of Slider 1 and Knob 1.

Notice how Knob 1 changes the overtone frequencies created by the FM, while Slider 1 changes their intensity.

9. While playing the keyboard, press the Control Surface’s Switch 1 to turn it on and off.

This enables and disables VPM Oscillator 1. When it’s off, you’ll hear VPM Oscillator 2 on its own: a pure sine wave. When programming, this is a handy way to find out how an individual VPM Oscillator is affecting the overall sound.

### Feedback

Continuing from the above, let’s take a brief look at **Feedback**. This causes the VPM Oscillator to modulate itself, essentially acting as both the carrier and the modulator at the same time.

1. Press Switch 1, so that its LED is off.

This mutes VPM Oscillator 1.

2. Play the keyboard.

Notice that the sound is now a sine wave, since we’re hearing only the un-modulated VPM Oscillator 2.

3. Go to the VPM Osc 2 page.

If you’re still on the Patch Panel page, you can do this by selecting any of the jacks on Osc 2 and then pressing the Jump button in Parameter Details.

Otherwise, select the Osc tab, and then the VPM Osc 2 tab.

4. While playing the keyboard, slowly raise the Feedback parameter to about 65.

Notice how the sound becomes brighter, almost like sweeping the filter on an analog synth. In fact, when **Feedback** is at 65, the sound is very close to a sawtooth waveform.

You can modulate the **Feedback** level, and also choose between two different feedback paths. For more information, see “Feedback” on page 367.

### Phase

In some cases, the phase relationship between the carrier and modulator has an interesting effect on the sound. Continuing from the above:

1. Lower VPM Osc 2’s Feedback to 0.

2. Go to the VPM Osc 1 page.

3. In VPM Osc 1, set the Ratio to 1.

Now, both VPM Osc 1 and 2 are set to the same Ratio, for the most basic FM timbre: a carrier/modulator ratio of 1.

4. Press Switch 1, so that its LED is On.

5. Set Slider 1 to the middle of its range.

6. While playing the keyboard, slowly increase VPM Osc 1’s Phase from 0 to 90.

Notice how the timbre changes.

Phase has a strong effect with carrier/modulator ratios of 1:1 and 2:1, but is much more subtle (or not noticeable at all) at other ratios.

---

## Detuning

Let's look at what happens when the carrier and modulator are slightly out-of-tune. Continuing from the above:

1. Set VPM Osc 1's Phase back to 0.
2. While playing the keyboard, use the Inc button to change VPM Osc 1's Freq Offset from +0000Hz to +0001 Hz.

Notice how this introduces a chorus effect into the sound.

3. While playing the keyboard, use the Dec button to change the Freq Offset back to +0000Hz.

Notice how the sound becomes more flat and static. A small amount of detuning can add a lot of interest to the sound.

4. While playing the keyboard, use the Inc button to change VPM Osc 1's Ratio Fine from +0.000 to +0.003.

This also adds a chorusing effect. There's a difference between changing the Ratio and the Freq Offset, however, as we'll see next:

5. Play different ranges of the keyboard: low, middle, and high, including all the way up to the top of the keyboard.

Notice how the speed of the chorus effect gets faster as you play higher. With Freq Offset, on the other hand, the speed stays the same across the keyboard. Each is useful for different purposes.

6. While playing the keyboard (arpeggios, for instance), use the VALUE slider to sweep VPM Osc 1's Ratio Fine throughout its range.

Notice how the effect changes with broader detuning, including new frequencies appearing both above and below the root pitch.

---

## Envelopes and VPM

Each VPM Oscillator can have its own volume envelope. As we've noticed by using Control Surface Slider 1, changing the level of a modulator affects the intensity of the FM. Envelopes let you create interesting timbres by varying that intensity over time.

Continuing from the above:

1. Set VPM Osc 1's Ratio Fine back to +0.000.

The main Ratio should still be set to 1.

2. Set the Output Level to 75.
3. Notice that the Output section's EG Select is set to EG1.

---

## Filtered VPM

Vintage FM synths didn't have filters. If you wanted the sound to be darker, or thinner, or change in timbre at all, you had to make it happen using FM.

Filtering adds another dimension to VPM, both in terms of timbral possibilities and ease of use. For instance, if you like the basic timbre but want it to be a little more mellow, you can use a lowpass filter.

This is the EG assigned to control the VPM Osc's volume. By default, EGs 1-6 are assigned to VPM Osc 1-6.

4. Go to the EG1 page, by pressing first the EG tab and then the EG1 tab.

5. Set the Break and Sustain Levels to 00.

Each note now has a "bowww" sound at the attack.

6. While playing the keyboard, go to the Control Surface and experiment with different settings of Knob 1 and Slider 1.

These change the Ratio and Output Level of VPM Osc 1. Notice the different sounds that this creates. Slider 1 will often work well in the mid-to-low ranges; don't keep it at the maximum level!

Next, let's create a more percussive sound:

7. In EG1, set the Decay Curve to 10(Exp).

8. Set the Decay Time to 22.

9. While playing the keyboard, go to the Control Surface and experiment with different settings of Knob 1 and Slider 1.

Depending on the Ratio (as set by Knob 1), this creates percussive sounds with woody or metallic characters.

---

## Modulating Ratio

So far, we've been using Tone Adjust to control Ratio. You may also sometimes want to modulate this with other controllers, or even with LFOs, EGs, and so on.

Ratio is one way of looking at pitch. On the MOD-7, you can modulate each VPM Oscillator's pitch in semitones and cents, just as with other KRONOS EXi. To do so, continuing from above:

1. Set VPM Osc 1's Ratio to 4.

Notice that the Parameter Details area, in the upper right of the screen, now has the heading "Pitch Modulation." This appears when any of the Ratio or Freq Offset parameters are selected.

2. Set AMS1 to SW1 Mod (CC#80), and Intensity to +12.00.

Now, pressing SW1 will raise the pitch of VPM Osc 1 by an octave.

3. Press SW1, to turn it on.

Notice how this changes the timbre of the attack.

4. Change AMS1 to LFO1.

Now, the pitch is modulated by LFO1. This gives the attack a swooping character, kind of like of a water droplet.

FM sweeps and resonant filter sweeps have different qualities; use each for what it does best, or use them together. Use highpass or bandpass filters, resonance, or the MultiFilter to achieve sounds impossible with FM alone.

Filters can even be used in-between modulators and carriers, as part of the VPM processing chain.

## Filtering the VPM output

Filtering the output of a set of VPM Oscillators is simple and effective. To do so:

1. Follow the instructions under “Creating an initialized MOD-7 Program” on page 341.
2. On the MOD-7 Patch Panel, set the Algorithm to 08: 2 + 2 + 2 -> Parallel Filters.
3. On the Control Surface, press switches 3 through 6, so that their LEDs turn off.

This mutes VPM Oscillators 3–6.

4. Go to the VPM Osc 1 page.

Remember that you can jump to this page directly from the Patch Panel. Just select one of the jacks on VPM Osc 1, and press the Jump button in the Parameter Details area.

5. Set the Output section’s EG Select to None.

This means that the volume will be at its maximum, unaffected by an EG.

6. Go to the Filter Basic page, by pressing first the Filter tab and then the Basic tab.
7. Set Filter A’s Resonance to 65.
8. While playing, move Slider 1 and Knob 7, and compare the different effects that they create.

Slider 1 controls the VPM Osc 1 Level, and thus the intensity of the FM on VPM Osc 2. Knob 7 controls Filter A’s Frequency, and so moving it creates a filter sweep.

## Filtering VPM modulators

You can also use filters as part of the VPM processing chain, between modulators and carriers. To do so, continuing from the above:

1. Go to the Patch Panel page.
2. Select Input 1 of the Main Mixer.

The Main Mixer is the tall block on the far right of the Patch Panel, and Input 1 is the top-most jack. Look in the Parameter Details area to verify that you’ve selected Main Mix and In 1.

## PCM as a VPM modulator

All of the examples above use VPM Oscillators as modulators, but you can also use the PCM Oscillator, Noise Generator, and the EXi Audio Input as modulators.

For instance, here are two quick tutorials in using PCM as an FM modulator, which was a popular feature on a few later-generation vintage FM synths.

### Single Multisample as VPM modulator

1. Follow the instructions under “Creating an initialized MOD-7 Program” on page 341.
2. On the Patch Panel page, press the button to the left of the Algorithm name to open the Algorithm Select pop-up.

3. Set In 1’s Level to 0.

When you select a jack, its level is always selected as well. So, you can use the data entry controls immediately, without needing to select the on-screen Level parameter.

4. Touch Filter A’s output (the blue jack) twice, so that the yellow highlight box is blinking.

This shows that the jack is ready to be connected via a patch cable.

5. Touch the first input jack on VPM Osc 4.

There should now be a brown cable connecting the output of Filter A to In 1 of VPM Osc 4.

Look in the Parameter Details area, and verify that it says Osc 4 at the top. Also, verify that the middle line reads In 1 ---> Filter A, Out.

You’ve now created a complex VPM patch, like this:

VPM Osc 1 -> VPM Osc 2 -> Filter A -> VPM Osc 4

6. Go to Filter A, and set its Resonance to 00.
7. On the Control Surface, press switch 4, so that its LED turns on.

This turns on VPM Osc 4.

8. Also on the Control Surface, set Slider 1 to the middle, and move Slider 2 all the way up.

9. Experiment with moving Knob 7 and Slider 2.

Knob 7 controls Filter A cutoff, and Slider 2 controls VPM Osc 2 Level. Listen to the different effects.

Note that VPM Osc 2 is now a modulator, affecting the timbre of VPM Osc 4. We aren’t hearing VPM Osc 2 directly.

10. Move Slider 2 to the top of its range.

Slider 2 controls the output volume of VPM Osc 2.

11. Set Filter A’s Type to Band Pass.

12. While playing, sweep Knob 7 between the minimum (all the way left) and the middle.

This produces interesting sounds—definitely filter-like, but not the same as using a filter in traditional subtractive synthesis.

3. In the Algorithm Select popup, select the Processing tab.

This small set of algorithms is designed for processing PCM or the EXi Audio Input through one or more VPM Oscillators.

4. Select Algorithm 51, PCM -> 1 -> 4-pole.

5. Go to the PCM Mod page.

To do so, select the Osc tab and then the PCM Mod tab.

6. Set the Octave to +1[4’].

Since VPM Osc 1’s Ratio is set to 1, this creates an FM ratio of 2:1.

7. Set the Output Level to 67.

8. Set the Velocity Sens to +050.

This lets velocity control the output level.

**9. Go to the PCM Oscillator page, and select different Multisamples for MS1.**

The choice of Multisample dramatically affects the sound. You can use any mono Multisamples, including ROM, EXs, User Sample Banks, and Sampling Mode data. Try these to start:

- Choir: 203 Voice-Choir
- Wavestation: 0597 “puh”
- Wavestation: 0619 VS 35
- SE 1: 1200 House Hits

---

**Velocity-switched Multisamples**

Of course, you can also velocity switch between different Multisamples. Continuing from the above:

**1. On the PCM Osc page, all MS1...4’s Type parameters to Multisample.****2. Set MS1...4’s Multisamples as follows:**

- MS1: 0510: MuteGtr2
- MS2: 0511: MuteGtr3

- MS3: 0509: MuteGtr1
- MS4: 0518: BassHarm

**3. Next, set the Bottom Velocities as follows:**

- MS1: 110
- MS2: 95
- MS3: 080

(MS4’s Bottom Velocity is always set to 1.)

**4. Go to the PCM Mod page.****5. Set the Output Level to 100, and the Octave to +0[8].****6. Play the keyboard at different velocities, and notice how the timbre changes.**

PCM samples can often be very bright and harmonically complex. When using bright or complex signals as FM modulators, high levels going into the carrier may result in lots of noise; to get good results, you may need to lower the modulator’s level significantly. You might also try processing the PCM (or any bright modulator signal) through a lowpass or bandpass filter, before sending it into the carrier.

---

**Waveshaping**

Waveshaping processes an input through a table, changing its timbre. You can use this in two different but related ways.

First, waveshaping offers a wide array of waveform options for the VPM Oscillator. There are 101 tables to choose from, and the way that the table interacts with the input signal can be modulated in real-time.

Second, waveshaping lets you process any signal, including PCM samples, the outputs of other oscillators, or real-time audio input. This capability provides a vast amount of sound-mangling potential, and has been a central feature of several classic digital synths.

For more information, see “5–4c: Waveshaper” on page 368.

---

**Creating different waveforms**

As with most other synthesis techniques, modulation is what really makes waveshaping come alive. Even without any modulation, however, waveshaping opens up a wide range of different waveforms, which can be useful both on their own, and as elements in an FM chain.

**1. Follow the instructions under “Creating an initialized MOD-7 Program” on page 341.****2. Go to the VPM Osc 1 page.****3. Set the Mode to Sine + Waveshaper.****4. In the Waveshaper section, set Key Slope to 1.**

**Key Slope** scales the **Drive** as you play higher and lower, primarily to minimize aliasing. 1 is a very mild setting, reducing **Drive** by 0.2dB per octave above C4.

**5. Set the Table to Linear.****6. Use Inc to step through tables; listen to the sound.**

Each of these simple, static waveforms can be altered—sometimes dramatically—by using **Offset** and **Drive**, even without any real-time modulation. They’ll also have different effects depending on the input signal; a complex, acoustic Multisample will give different results than a simple sine wave.

---

**Using Offset**

By modulating offset, we can make a quick-and-simple reed piano sound, using only a single VPM Oscillator.

Continuing from the above:

**1. In the Waveshaper section of VPM Osc 1, set the Offset to +090.****2. In the Parameter Details area, set Offset AMS to Exponential Velocity, and set Intensity to -090.****3. Set Drive to -06dB.****4. Set Makeup Gain to +06dB.****5. Set the Table to Pickup1.**

In the popup list, **Pickup1** is near the top of the first column.

**6. Set Key Slope to 5.**

The steps are in 0.2dB/octave, so 5 is 1dB/octave.

**7. Play the keyboard, and notice how the sound changes at different velocities.**

## Creating evolving timbres

Next, let's see how waveshaping sounds when modulated from an envelope. Continuing from the above:

1. Go to the EG3 page.
  2. Set the Attack Time to 70, and the Decay Time to 90.
  3. Set both the Break and Sustain Levels to 00.
- This creates an envelope which sweeps slowly up and down.
4. Go to the VPM Osc 1 page.
  5. Set Offset to +000.
  6. In Parameter Details, set Offset AMS Intensity to +000.
  7. Set the Drive to -36dB.
  8. In Parameter Details, set Drive AMS to EG3, and Intensity to +36dB.

By modulating the Drive, EG3 changes the way that the table interacts with the input signal—creating an effect that varies over time.

9. Set the Table to Forest.

In the popup list, Forest is near the top of the fourth column.

10. While playing the keyboard, use Inc to step through the different tables.

This is a fairly slow envelope, so for this example just play simple chords, and hold them to hear the sound as the EG sweeps through the table.

## Waveshaping and VPM

Continuing from the above:

1. Go to the Patch Panel page.
2. Touch VPM Osc 1's Output jack twice, so that the yellow square starts to blink.
3. Touch VPM Osc 2's Input 1 jack.

A patch cable will appear, connecting VPM Osc 1's Output to VPM Osc 2's Input 1.

4. Similarly, touch VPM Osc 2's Output jack twice, and then touch Input 1 on the Main Mixer.

Input 1 is the top-most jack on the Main Mixer, just below the Parameter Details area. VPM Osc 1 is connected to this jack by default, as you can see by the thin black line. The new patch cable replaces that normalised connection, so now we'll hear only VPM Osc 2.

5. Press the front-panel Tone Adjust button.

This will be useful later, so that we can easily adjust VPM Osc 1's Level with Slider 1.

Next, let's get rid of the Drive modulation, so that we can hear the table on its own:

6. Go to the VPM Osc 1 page.
7. Set Drive to 0dB.
8. In Parameter Details, set Drive AMS Intensity to 0dB.
9. Set the Table to Linear.

This will sound just as if Osc 1 was set to the Sine waveform.

10. Use Inc to step through the tables, and experiment with different settings of Slider 1 (VPM Osc 1 Output Level).

Start with Slider 1 around the mid-point, and keep trying out different levels as you listen to the different tables. The brighter the modulator's waveform, the less level you'll need. If the level is too high, you'll start to hear noise and grit.

Finally, let's bring back the EG3 modulation of Drive:

11. Set Drive to -36dB.
12. In Parameter Details, set Drive AMS Intensity to +36dB.
13. Again, use Inc to step through the tables, and experiment with different settings of Slider 1.

## Waveshaping and PCM

You can use waveshaping to alter any mono sample in the KRONOS, including sounds from ROM, EXs, User Sample Banks, and Sampling Mode.

Continuing from the above:

1. Go to the Patch Panel.
2. Select Algorithm 51, PCM -> 1 -> 4-pole.
3. Open the menu, and select the Delete All Connections command.

An "Are you sure?" dialog will appear.

4. Press OK to confirm the deletion.

All of the cables will disappear, returning the algorithm to its default state.

5. Go to the PCM Osc page.
6. Set MS1 Multisample to 0330:El.Bass-Slap Muted.
7. Go to the PCM Mod page.
8. Set Velocity Sens +050.

This makes the level respond to velocity. Since the waveshaper's effect changes with the input level, this means that velocity will also affect the timbre.

9. Go to the VPM Osc 1 page.
10. Set the Mode to Waveshaper.

This means that VPM Osc 1 is no longer an oscillator per se; instead, it's functioning as a waveshaper, processing the output of the PCM Oscillator.

11. Set the Table to Resonant2.

In the popup list, Resonant2 is near the middle of the third column.

12. Set Drive to -30dB.
13. In Parameter Details, Set Drive AMS to EG3, and set the Intensity to +30dB.
14. Set Offset to +50.
15. In Parameter Details, Set Offset AMS to Exponential Velocity, and set the Intensity to -50.
16. Set the Makeup Gain to +24dB.

17. Play a slow bass line on the keyboard.

Notice the "filter sweep" sound. This comes entirely from modulating the drive through the table; by itself, the multisample has a very dark tone.



---

## Waveshaping and filtered PCM

Using PCM with waveshaping produces unique results, but it can also be tricky to control. You'll probably need to experiment to find which tables best match a particular Multisample. Often, waveshaping works better with darker input sounds, so it may be useful to patch in a lowpass filter between the PCM and the VPM Oscillator.

Continuing from the above:

1. Go to the PCM Osc page.
2. Set MS1 Multisample to 0201:Voice-Pop Ah.
3. Go to the Patch Panel.
4. Connect the PCM Osc Output to Filter A's Input.
5. Connect Filter A's Output to VPM Osc 1's Input 1.
6. Connect VPM Osc 1's Output to Input 1 on the Main Mixer.

Now, the signal flow is PCM -> Filter A -> VPM Osc 1 -> Output.

### 7. Play the keyboard.

At this point, the sound is pretty buzzy. Let's see what the filter will do:

8. While playing a chord in the middle of the keyboard, move Knob 7 so that it's slightly to the left of center.

This lowers the cutoff frequency of the filter, so that the sound changes from buzzy to mellow—but the waveshaper is still having a strong effect.

---

## Waveshaping, PCM, and VPM

You can use Waveshaping, PCM, and VPM simultaneously, for even more complex timbres.

Continuing from the above:

1. Go to the PCM Mod page.
2. Set Freq Offset to +01.0.

---

## Ring Modulation

Ring modulation takes two input signals, and creates new frequencies based on those inputs. It can create everything from subtle brightening effects to wild, dissonant, gong-like timbres.

In the MOD-7, each VPM Oscillator includes a ring modulator. You can use this to process any combination of VPM, PCM, noise, and real-time audio input. You can also modulate the wet/dry crossfade of the ring modulator, in real-time.

For more information, see "5-4e: Ring Modulator" on page 373.

---

## Subtle motion

Let's first look at a subtle use of ring modulation, to create some motion in a simple sawtooth timbre.

1. Follow the instructions under "Creating an initialized MOD-7 Program" on page 341.

To start, we'll create an envelope for modulation:

The PCM will be a modulator in this sound, and so this adds a little chorus effect to the end result.

3. Go to the VPM Osc 1 page.

4. Set the Mode to Sine + Waveshaper.

Now, VPM Osc 1 works as an oscillator again, and we're back in the realm of FM synthesis. The filtered PCM sound is the modulator, and the VPM Osc is the carrier.

5. Set Input Level 1 to 80.

This controls the intensity of the modulation from the filtered PCM.

6. Set the Table to Mixture4.

In the popup list, Mixture4 is near the bottom of the second column.

7. Set Drive to -36dB.

8. In Parameter Details, set the Drive AMS Intensity to +30dB.

This means that the input won't quite use the entire table, and leaves room for Offset to move the active region of the table without clipping.

9. Experiment with different settings of Knob 7.

This controls the cutoff frequency of Filter A. This filter isn't processing the output of VPM Osc 1; it's just affecting the modulator signal going *into* VPM Osc 1. VPM Osc 1 itself is connected directly to the Main Mixer, bypassing the filters.

Finally, note that all of the examples above used only a single VPM Oscillator—just a fraction of the MOD-7's resources. You can process PCM through all six VPM Oscillators, in serial or parallel. For an example of this, listen to factory MOD-7 Program USER-F 049, "Dancing Waveshapes." This processes the PCM through all six VPM Oscillators in parallel, including both VPM and waveshaping. Each creates a different timbre, and rhythmically triggered envelopes switch between them in turn.

2. Go to the EG3 page.

3. Set the Attack Time to 70, and the Decay Time to 90.

4. Set both the Break and Sustain Levels to 00.

Next, let's connect VPM Osc 2 to VPM Osc 1:

5. Go to the Patch Panel.

6. Connect VPM Osc 2's Output to VPM Osc 1's Input 1.

7. Go to the VPM Osc 2 page.

8. Set the Ratio to 2.

9. In Parameter Details, set Pitch Modulation AMS1 to EG3, and set the Intensity to +00.10.

This small amount of pitch modulation will create a more subtle ring modulation effect.

10. Go to the VPM Osc 1 page.

11. Set the Mode to Saw.

12. Set Input Level 1 to 0.

This means that VPM Osc 2 will only affect the ring modulator.

**13. Set the LPF to 50.**

**14. Play the keyboard; so far, this is a simple sawtooth sound.**

**15. On the VPM Osc 1 page, select the Ring Mod Crossfade parameter.**

**16. In Parameter Details, set the Crossfade AMS to EG3, and the Intensity to 100.**

Now, EG3 is doing two things: it's changing the pitch of VPM Osc 2, and fading the ring modulation in and out. Together, this creates a fluttering, rolling effect.

---

## Attack transient

Next, we'll use ring modulation to create an attack transient. Continuing from the above:

- 1. Go to the EG3 page.**
- 2. Set the Attack Time to 00, and the Decay Time to 40.**
- 3. Go to the VPM Osc 2 page.**
- 4. Set the Mode to Saw.**
- 5. Set the LPF to 60.**
- 6. Select the Ratio parameter.**

This makes the Pitch Modulation parameters appear in the Parameter Details area.

**7. Change the AMS1 Intensity to +02.00.**

This will result in a stronger ring modulation effect.

**8. Go to the VPM Osc 1 page.**

**9. Set the Mode to Sine.**

This makes the effect of the ring modulation more obvious, when crossfaded in and out.

**10. Play the keyboard.**

Now, the ring modulation is creating a chiff at the start of the note.

---

## Extreme sweep

For a more surreal ring modulation effect:

- 1. Go to the EG3 page.**
- 2. Set the Decay Time to 80.**
- 3. Go to the VPM Osc 2 page.**
- 4. Set the Ratio Fine to +0.002.**

This will create a little motion in the sustained sound, after the initial sweep is complete.

- 5. Go to the VPM Osc 1 page.**
- 6. Set the Mode to Saw.**
- 7. Set the Ring Mod Crossfade to Ring Mod.**
- 8. In Parameter Details, set the AMS Intensity to 000.**

Now, the output will contain only the ring mod sound. Previously, the sound had crossfaded between the dry and ring mod timbres.

**9. Play a chord on the keyboard, and hold it until the sound settles.**

---

## Conclusion

We've now looked at most of the synthesis techniques provided by the MOD-7, including subtractive, VPM, PCM + VPM, waveshaping, and ring modulation. To step beyond the basics, try looking through some of the factory sounds to see how they work. There's still much more to discover, and we hope that you enjoy playing and working with the MOD-7 as much as we do!

## EXi Program P0: Play

### 0-1: Main

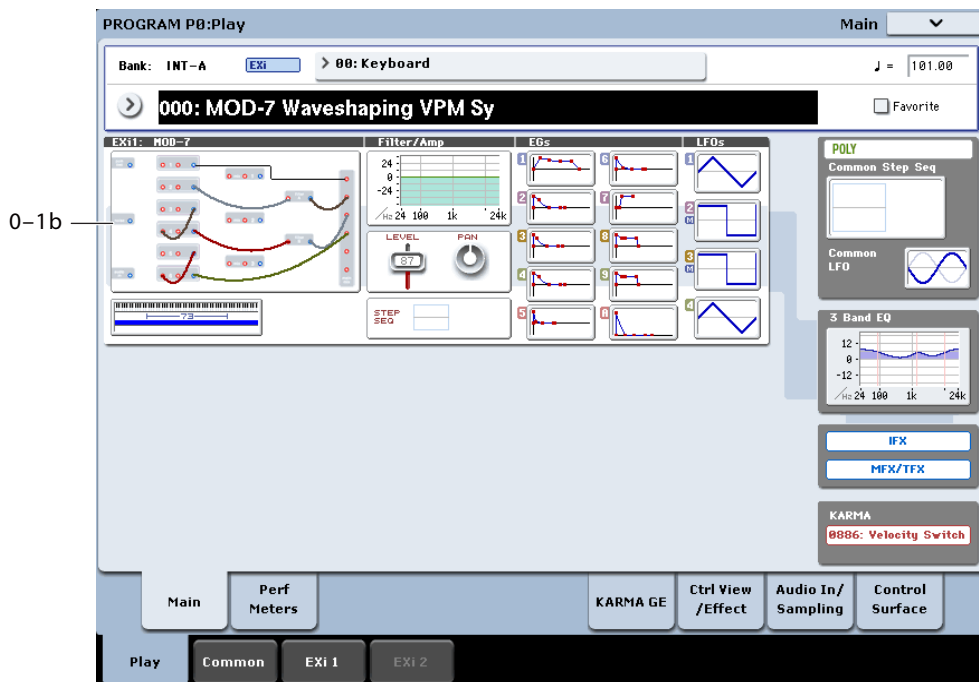

This is the main page of Program mode. For a full description of this page and all of its functions, please see “EXi Program P0: Play” on page 165. This section describes only the overview display, which differs for each individual EXi.

#### 0-1b: Overview and Page Jump

This part of the page shows an overview of the most important settings for the Program’s two EXi instruments. The specific parameters will vary, depending on which EXi are being used. The specific parameters for the MOD-7 are described below.

The graphics give you a quick way to check all of these settings at a glance. They also let you jump instantly to any of the displayed parameters. Just touch one of the sections, and you’ll jump to the page containing its parameters. For instance, if you touch the Filter graphic, you’ll go to the Oscillator and Filter page.

*Tip:* Pressing EXIT several times will always bring you back to this page.

#### Patch Panel

This section shows a miniature version of the patch panel, including patch cables and the selected algorithm’s normalised connections. Touch this area to jump directly to the Patch Panel page.

#### Filter

##### Filter

This shows a graphic representation of the filter frequency response, including cutoff and resonance.

Press this area to jump to the Filter Basic page.

#### Amp

##### Pan, Amp Level

This shows the Amp section’s Pan and Amp Level values.

Press this area to jump to the Amp page.

#### EGs, LFOs, and Step Sequencer

##### EG Graphics

These show the shapes of all 10 EGs, including EGs 1-9 and the Amp EG. Touch either of them to jump directly to the corresponding edit page.

##### LFO 1-4 Graphics

These show the waveforms and shapes of the four LFOs. Touch them to jump directly to the corresponding edit page.

If the LFO is synchronized to tempo, a small “M” appears under the LFO number (short for “MIDI Clock”).

##### Step Sequencer

This shows a graphic overview of the per-voice Step Sequencer.

Press this area to jump to the Step Sequencer page.

#### Key Zone

##### Key Zone

This shows the key zones for EXi1 and EXi2, as set on the Common section’s Program Basic page, in relation to the entire MIDI note range. The range of the 61-, 73-, or 88-note keyboard is also shown, as appropriate.

Press this area to jump to the Program Basic page.

### **Common**

The graphics along the right side of the screen show the most important Common parameters, which are shared by both EXi in the Program. This section will always show the same parameters, regardless of which EXi are being used.

### **Common Voice Assign Mode**

This shows the voice assign mode of the Program—either POLY or MONO.

Press this area to jump to the Program Basic page.

### **Common Step Sequencer**

This shows a graphic overview of the Common Step Sequencer.

Press this area to jump to the Common Step Sequencer page.

### **Common LFO Graphic**

This shows the waveform of the Common LFO.

Press this area to jump to the Common LFO page.

### **3 Band EQ Graphic**

This shows the mid-sweepable 3-band EQ.

Press this area to jump to the EQ page.

### **IFX, MFX/TFX**

Press the IFX area to jump to the IFX Routing page.

Press the MFX/TFX area to jump to the MFX Routing page.

### **KARMA GE Name**

This shows the name of the selected KARMA GE.

Press this area to jump to the GE Setup/Key Zones page.

## Program P4: Patch Panel

### 4-1: Patch Panel

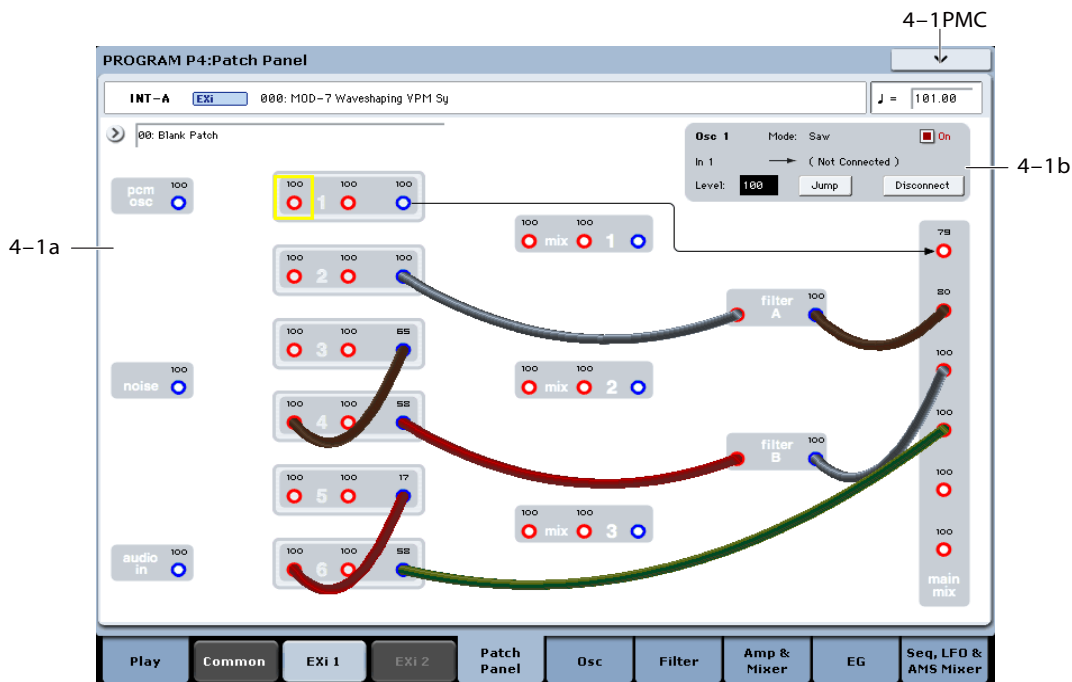

The patch panel shows an overview of most components in the MOD-7, and lets you:

- Control the connections between components (oscillators, filters, mixers, and so on) by selecting algorithms and/or using patch cables
- Edit input and output levels for all components
- Jump directly to the detailed editing pages for all components

### Using the Patch Panel

#### Algorithms

Depending on the selected algorithm, many of the MOD-7 elements (VPM oscillators, PCM oscillator, Noise Generator, filters, mixers, etc.) are connected by default, even without using any patch cables. The lines and arrows on the Patch Panel show these “normal” signal paths.

You can change any and all of these default connections using patch cables, as desired. Plugging a cable into an *input* jack disconnects the “normal” path, and uses the signal from the cable instead. Plugging a cable into an *output* jack does not affect the normal path, since a single output can be connected to any number of inputs.

For more information on using algorithms, see “4-1a: Algorithm Select” on page 353.

#### Basic patching rules

Inputs are colored red, and outputs are colored blue.

Each input can be connected to a single output, and no more (although a single *output* can be connected to multiple *inputs*, as described below). If you want to route two outputs to a single input, use one of the mixers to merge the outputs first.

Plugging a cable into an output jack lets you use the signal elsewhere on the patch panel, and does not interrupt the “normal” path. You can also connect a single output to any number of inputs, if you like; this is sometimes called a “mult.” The signal strength remains the same, as if you were using a distribution amplifier.

Connections from one input to another, or from one output to another, are not allowed.

### Creating and deleting connections

#### Making connections

To make a connection between two patch points:

1. **Touch one of the two jacks (either input or output).**

A yellow square will appear around the selected jack. The Detail Panel will also show the name of the selected jack, and what it is connected to.

2. **Touch the same jack again.**

The yellow square will begin to blink, showing that you’re about to make a connection. To cancel this and return to the normal selected state, just touch the same jack a third time.

3. **Touch the other jack.**

The two jacks will now be connected.

## Deleting connections

To delete a connection between two patch points:

### 1. Touch the input jack.

Note: you can also select the output jack. However, if the output is connected to more than one input, all of the connections from that output will be affected.

### 2. Press the Disconnect button in the Detail Panel.

The selected connection will be deleted.

To delete all connections from an output:

### 1. Touch the output jack.

### 2. Press the Disconnect button in the Detail Panel.

All of the output's connections will be deleted. This is convenient if an output has been connected to multiple inputs, and you want to clear all of them at once.

## Clearing all connections from the Patch Panel

To completely clear the Patch Panel, so that you can start from scratch:

### 1. Open the menu, and select the Delete All Connections command.

All connections will be deleted.

## Setting input and output levels

You can edit the main input and output levels for each block directly from the Patch Panel. To do this:

### 1. Select the jack whose input level you want to edit.

For instance, select Input 2 of VPM Oscillator 4.

### 2. Use the standard data-entry controls to set the level as desired.

Note that modulation can affect these levels, as well—so you may have to look at the individual edit pages to get the complete picture.

## Jumping directly to edit pages

You can jump to the detailed edit pages for any of the blocks shown on the Patch Panel. To do this:

### 1. Select a jack on the block that you want to edit.

You can select any input or output on the block.

### 2. Press the Jump button in the Parameter Details area, at the top right of the display.

This will take you directly to the page of the selected jack's block. For instance, if you've selected one of the inputs or outputs of VPM Oscillator 2, pressing **Jump** will take you to the **VPM Osc 2** page.

## Muting oscillators

The PCM Oscillator and each VPM Oscillator can be muted temporarily, so that you can hear their effect on the sound. To do this, select any of the block's input or output jacks, and edit the check-box in the parameter details area. You can also use Tone Adjust buttons 1-6 (VPM Osc 1-6) and 9 (PCM), which are assigned to these parameters by default.

## Filter B and 4-pole routing

When the filter **Routing** is set to **4-pole**, only Filter A is active. Filter B no longer passes any audio from input to output, and both input and output jacks are grayed out.

Any cables previously connected to Filter B will remain in place, with their color changed to black & red to indicate the filter's disabled status.

## 4-1a: Algorithm Select

### Algorithm

[List]

Algorithms do three things:

- They create a set of default connections between the elements on the Patch Panel, which can then be altered as you wish using patch cables.
- As part of these connections, they set the Link parameters for Mixers 1, 2, and 3, as well as the Filter's 4-pole/Parallel parameter.
- They specify which VPM Oscillators are carriers, and which are modulators. This affects the way that the Macro parameters work. You can edit these settings after selecting an Algorithm, if desired, to account for changes due to user-created patch cables or oscillator settings.

### Algorithm groups

The algorithms are divided into several groups, selected by tabs on the left-hand side of the Algorithm Select popup.

**VPM** includes the most useful configurations of VPM Oscillators, routed through either 4-pole or parallel filters. The **PCM** and **Noise** algorithms, below, are primarily based on this set of configurations.

The first entry, **Blank Patch**, is a special algorithm with only the simplest of connections: VPM Oscillator 1 goes straight into the main mixer. Use this if you want to build your own algorithm from the ground up.

**PCM + VPM** offers a selection of VPM configurations layered with PCM samples.

**PCM->Filter->VPM** includes the standard set of configurations, using PCM (through a 2-pole filter) as an FM modulator.

**PCM->VPM -> 4-pole** are similar, but these route the unfiltered PCM directly into the VPM Oscillators, and then processes the result through a 4-pole filter.

**Noise->VPM -> 4-pole** use the Noise Generator as an FM Modulator.

Many of the **PCM** and **Noise** algorithms have two variations, labeled **I** and **II**. In the **I** versions, the PCM or Noise goes to the input of a Modulator; in the **II** versions, the PCM or Noise is routed to the second Carrier input, in parallel with the VPM Modulator.

**Processing** are special algorithms for simple waveshaping, ring modulation, and/or FM modulation with PCM or live audio input.

**Vintage DX** features all of the original DX7 algorithms, without any filtering. Feedback is much more flexible on the MOD-7 than it was on the DX7, and so when the

original algorithms differed only by feedback routing, they've been grouped into a single selection. To disable an external feedback routing, just go to the input jack that the feedback leads to, and set its **Level** to 0.

Remember, you can use patch cables to change any of these algorithms to suit your needs.

**Which algorithm should I use?**

Algorithms are just shortcuts for configuring the Patch Panel. You don't have to use them at all; if you prefer, you can just make all of your connections using patch cables.

The preset algorithms do make it easy to call up commonly-used setups, however.

In general, with more carriers, there's more potential for layering; with fewer carriers, there's more potential for complex and detailed FM modulation.

The "all carriers" algorithms (10, 20, 30, 40, 50, and DX #32) are good for creating thick layers, or for simple additive synthesis (up to 7 partials, plus noise, each with its own EG).

The Processing algorithms are a good place to start if you want to transform a PCM sample into something new, or process a live audio input.

The PCM + VPM algorithms are good for layering samples with VPM.

#	Group	Algorithm
0	VPM	Blank Patch
1		4+2 -> 4-pole
2		3+3 -> 4-pole
3		2+2+2 -> 4-pole
4		2+2+1+1 -> 4-pole
5		All carriers -> 4-pole
6		4+2 -> parallel filters
7		3+3 -> parallel filters
8		2+2+2 -> parallel filters
9		2+2+1+1 -> parallel filters
10	All carriers -> parallel filters	
11	PCM + VPM	PCM+4+2 -> 4-pole
12		PCM+3+3 -> 4-pole
13		PCM+2+2+2 -> 4-pole
14		PCM+2+2+1+1 -> 4-pole
15		PCM+2+1+1+1+1 -> 4-pole
16		PCM+4+2 -> parallel filters
17		PCM+3+3 -> parallel filters
18		PCM+2+2+2 -> parallel filters
19		PCM+2+2+1+1 -> parallel filters
20		PCM+all carriers -> parallel filters

#	Group	Algorithm
21	PCM->Filter->VPM	PCM -> 4+2 -> 2-pole I
22		PCM -> 4+2 -> 2-pole II
23		PCM -> 3+3 -> 2-pole I
24		PCM -> 3+3 -> 2-pole II
25		PCM -> 2+2+2 -> 2-pole I
26		PCM -> 2+2+2 -> 2-pole II
27		PCM -> 2+2+1+1 -> 2-pole I
28		PCM -> 2+2+1+1 -> 2-pole II
29		PCM -> 3+1+1+1 -> 2-pole
30		PCM -> all carriers -> 2-pole
31	PCM->VPM -> 4-pole	PCM -> 4+2 -> 4-pole I
32		PCM -> 4+2 -> 4-pole II
33		PCM -> 3+3 -> 4-pole I
34		PCM -> 3+3 -> 4-pole II
35		PCM -> 2+2+2 -> 4-pole I
36		PCM -> 2+2+2 -> 4-pole II
37		PCM -> 2+2+1+1 -> 4-pole I
38		PCM -> 2+2+1+1 -> 4-pole II
39		PCM -> 3+1+1+1 -> 4-pole
40		PCM -> all carriers -> 4-pole
41	Noise->VPM -> 4-pole	Noise -> 4+2 -> 4-pole I
42		Noise -> 4+2 -> 4-pole II
43		Noise -> 3+3 -> 4-pole I
44		Noise -> 3+3 -> 4-pole II
45		Noise -> 2+2+2 -> 4-pole I
46		Noise -> 2+2+2 -> 4-pole II
47		Noise -> 2+2+1+1 -> 4-pole I
48		Noise -> 2+2+1+1 -> 4-pole II
49		Noise -> 3+1+1+1 -> 4-pole
50		Noise -> all carriers -> 4-pole
51	Processing	PCM -> 1 -> 4-pole
52		PCM -> 1+1+1 -> 4-pole
53		Audio -> 1 -> 4-pole
54		Audio -> 1+1+1 -> 4-pole



#	Group	Algorithm
55	Vintage DX	DX #1 & #2
56		DX #3
57		DX #4
58		DX #5
59		DX #6
60		DX #7, #8, & #9
61		DX #10 & #11
62		DX #12 & #13
63		DX #14 & #15
64		DX #16 & #17
65		DX #18
66		DX #19
67		DX #20
68		DX #21
69		DX #22
70		DX #23
71		DX #24
72		DX #25
73		DX #26 & #27
74		DX #28
75		DX #29
76		DX #30
77		DX #31
78		DX #32

### 4-1b: Parameter Details

This area at the upper right of the display shows information for both the selected jack, and the block containing that jack.

**(Block name)** [PCM Osc, Noise, Audio In, VPM Osc 1...6, Mixer 1...3, Filter A...B, Main Mixer]

This read-only parameter shows the name of the selected block.

**Mode** [Off, Sine, Saw, Triangle, Square, Sine + Waveshaper, Waveshaper, Ring Mod Only]

When a VPM Oscillator is selected, this read-only parameter shows the Oscillator Mode.

**On** [Check-box]

This check-box lets you temporarily mute the output of the block. It duplicates the similarly-named parameter on the Oscillator's page.

**(Jack name)** [Depends on block]

This read-only parameter shows the name of the selected jack, such as Input 1.

**(Connection)** [Jack name]

This read-only parameter shows the jack to which the selected jack is connected, including the normalled connection. If nothing is connected to the jack, the bottom line reads "(No Connection)."

If the selected jack is an output connected to multiple inputs, only the first connection is shown, followed by an ellipse.

If the default connection from Algorithm is active, it is shown in parentheses.

**Input or Output Level** [0...100]

This sets the input or output volume level of the jack. It duplicates the similarly-named parameter on the block's page.

#### Jump

Press the **Jump** button to go directly to the page of the selected jack's block. For instance, if you've selected one of the inputs or outputs of VPM Oscillator 2, pressing **Jump** will take you to the **VPM Osc 2** page.

#### Disconnect button

Pressing the **Disconnect** button clears all cables connected to the jack.

### ▼ 4-1: Page Menu Commands

The number before each command shows its ENTER + number-key shortcut. For more information on these shortcuts, see "ENTER + 0-9: shortcuts for menu commands" on page 147.

- 0: **Write Program**. For more information, see "Write Program" on page 147.
- 1: **Exclusive Solo**. For more information, see "Exclusive Solo" on page 147.
- 2: **Delete All Connections**. For more information, see "Delete All Connections" on page 321.
- 3: **Copy VPM Oscillator**. For more information, see "Copy VPM Oscillator" on page 386.
- 4: **Swap VPM Oscillators**. For more information, see "Swap VPM Oscillators" on page 386.

# Program P5: Oscillators

## 5-1: Osc Main

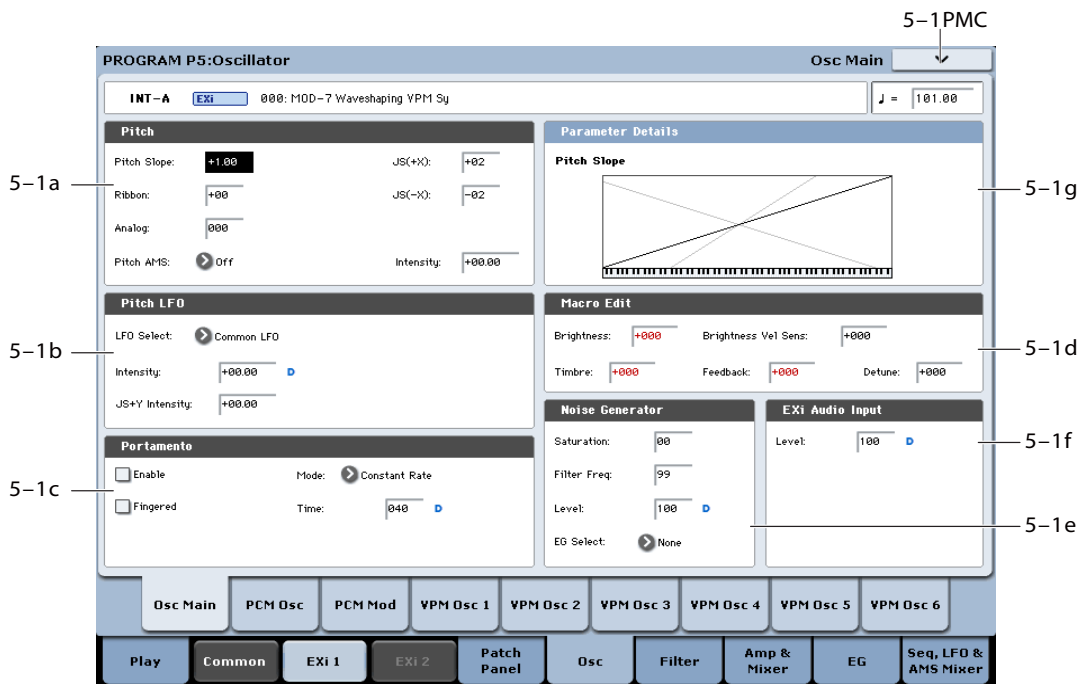

This page includes:

- Pitch slope and portamento settings
- Pitch modulation applied equally to the PCM Oscillator and all six VPM Oscillators (note that individual oscillators have their own pitch modulation, as well)
- Macro parameters, for quick edits to VPM sounds
- Carrier/Modulator settings for the six VPM Oscillators
- Noise Generator settings
- Audio Input settings

*Pitch Slope, pitch, and note*

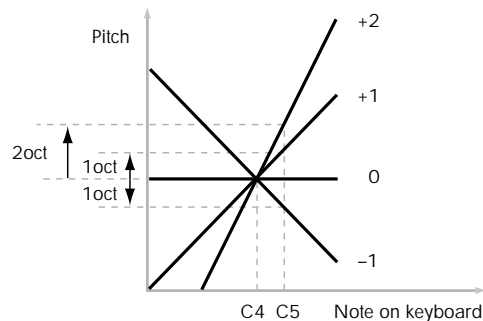

### 5-1a: Pitch

These parameters let you modulate the pitch of the PCM Oscillator and all 6 VPM Oscillators simultaneously, so that the modulation applies equally to all of them.

#### Pitch Slope [-1.00...+0.00...+2.00]

Normally, this should be set to the default of +1.00.

**Positive (+)** values cause the pitch to rise as you play higher on the keyboard, and **negative (-)** values cause the pitch to *fall* as you play higher on the keyboard.

When this is set to 0, playing different notes on the keyboard won't change the pitch at all; it will be as if you're always playing C4. This can be useful for special effects sounds, for instance.

If you want to create more complex effects, you can assign key tracking as an AMS source.

#### Ribbon [-60...+60 semitones]

You can use the ribbon controller for pitch-bend. This parameter specifies, in semitones, the ribbon's pitch-bend range.

**Positive (+)** values make the pitch rise when you press the ribbon controller to the right of center, and **negative (-)** values will cause the pitch to fall.

When you lift off of the ribbon, the pitch will snap back to the center (unless you're using the SW1/2 "Ribbon Lock" feature). So, by tapping on the right edge of the ribbon and then releasing quickly, you can create guitar-style "hammer-on" effects.

#### JS+ X [-60...+60 semitones]

This sets the maximum amount of pitch bend, in semitones, when you move the joystick to the right. For normal pitch bend, set this to a positive value.

**JS- X** [-60...+60 semitones]

This sets the maximum amount of pitch bend, in semitones, when you move the joystick to the left. For normal pitch bend, set this to a negative value.

**Analog** [000...100]

This models the instability of an analog system by adding subtle randomization to the oscillator and filter frequencies. The PCM Oscillator, each VPM Oscillator, and Filters A and B each receive different random values, and the values are different for each new note as well.

**Pitch AMS** [List of AMS Sources]

This selects an AMS source to modulate the pitch of all oscillators simultaneously. For a list of AMS sources, see “Alternate Modulation Source (AMS) List” on page 1091.

**Intensity** [-48.00...+48.00]

This controls the depth and direction of the Pitch AMS modulation, in semitones.

**Pitch Slope Parameter Details**

The **Pitch Slope** graphic appears in the Parameter Details area when any of the Pitch parameters are selected.

**5-1b: Pitch LFO**

**LFO Select** [LFO 1, LFO 2, LFO 3, LFO 4, Common LFO]

This selects an LFO to modulate all oscillators simultaneously. This shared modulation can be useful for vibrato, among other things.

The **LFO Intensity**, **JS+ Y Intensity**, and **AMS** are all summed together to produce the final amount of LFO pitch modulation.

**LFO Intensity** [-48.00...+48.00]

This controls the initial effect of the LFO on the pitch, in semitones, before any JS+Y or AMS modulation.

**Negative (-)** settings will invert the phase of the LFO.

**JS+Y Intensity** [-48.00...+48.00]

Moving the joystick “up” from the center detent position, away from yourself, produces the JS+Y controller. You can use this to scale the amount of the LFO applied to the pitch. This parameter sets the maximum amount of LFO modulation added by JS+Y, in semitones.

As this value is **increased**, moving the joystick in the +Y direction will cause the LFO to produce deeper pitch modulation.

**Negative (-)** settings will invert the phase of the LFO. You can also use this to reduce the initial amount of the LFO, as set by **LFO1 Intensity**, above.

**Pitch LFO Parameter Details**

These items appear in the Parameter Details area when any of the Pitch LFO parameters are selected.

**AMS** [List of AMS Sources]

This selects an AMS modulation source to scale the amount of the LFO applied to pitch.

For a list of AMS sources, see “Alternate Modulation Source (AMS) List” on page 1091.

**Intensity** [-48.00...+48.00]

This controls the depth and direction of the LFO AMS modulation, in semitones.

**5-1c: Portamento**

Portamento lets the pitch glide smoothly between notes, instead of changing abruptly.

**Enable** [Off, On]

**On (checked):** Turns on Portamento, so that pitch glides smoothly between notes.

**Off (unchecked):** Turns off Portamento. This is the default state.

**Fingered** [Off, On]

This parameter allows you to control Portamento through your playing style. When it’s enabled, playing legato will turn on Portamento, and playing detached will turn it off again.

This option is only available when Portamento Enable is turned on.

**On (checked):** Turns on Fingered Portamento.

**Off (unchecked):** Turns off Fingered Portamento.

**Mode** [Constant Rate, Constant Time]

**Constant Rate** means that Portamento will always take the same amount of time to glide a given distance in pitch - for instance, one second per octave. Put another way, gliding several octaves will take much longer than gliding a half-step.

**Constant Time** means that Portamento will always take the same amount of time to glide from one note to another, regardless of the difference in pitch. This is especially useful when playing chords, since it ensures that each note in the chord will end its glide at the same time.

**Time** [000...127]

This controls the portamento time. Higher values mean longer times, for slower changes in pitch. When **Time** is set to **0**, the pitch will be reached instantly—just as if Portamento **Enable** was turned **Off**.

**Portamento Parameter Details**

These items appear in the Parameter Details area when any of the Portamento parameters are selected.

**AMS** [List of AMS Sources]

This selects an AMS source to control the **Portamento Time**. For a list of AMS sources, see “Alternate Modulation Source (AMS) List” on page 1091.

The modulation occurs only at note-on. This means that you can change the time for the *next* pitch glide, but you can’t change any glides which are already in progress.

**Intensity** [-127...+127]

This controls the depth and direction of the **Portamento Time** AMS modulation.

**Assigning SW1 or SW2 to Portamento On/Off**

You can use the two assignable switches, SW1 and SW2, to turn portamento on and off.

To do so:

1. Go to Program page 1-8, Controller Setup.
2. Under Panel Switch Assign, set either SW1 or SW2 to Portamento SW (CC#65).

Now, the selected switch will enable and disable Portamento. It will also send the MIDI Portamento controller, CC#65.

**MIDI** Even if you don't assign SW1/2 to Portamento, you can still use MIDI Controller #65 to turn Portamento on and off.

**5-1d: Macro Edit**

**Brightness** [-100...+100]

This controls the input levels of all Carriers (see "Oscillator Carrier/Modulator Status," below).

**Brightness Vel. Sens.** [-100...+100]

This controls the output level velocity sensitivities of all Modulators.

**Timbre** [-100...+100]

This controls the pitches of all Modulators.

**Feedback** [-100...+100]

This controls the feedback levels of all Carriers.

**Detune** [-100...+100]

This controls the fine-tuning of all Modulators.

**Macro Edit Parameter Details**

**Oscillator Carrier/Modulator Status**

These items appear in the Parameter Details area when any of the Macro parameters are selected. They control the way that each VPM Oscillator responds to the Macro parameters, as detailed below.

**Modulators** are affected by the **Brightness Vel Sens.**, and **Timbre** parameters.

**Carriers** are affected by the **Brightness**, **Feedback** and **Detune** parameters.

The Carrier/Modulator states are set automatically when an **Algorithm** is selected, but may then be edited manually as desired, to match any special configurations on the Patch Panel.

Note that these settings only affect the way that the VPM Oscillators respond to the Macro Parameters; they do not make an oscillator into a Carrier or Modulator per se.

**VPM Osc 1...6s** [Carrier, Modulator]

This controls the way that each VPM Oscillator responds to the Macro parameters, as described above.

**5-1e: Noise Generator**

The noise generator includes **Saturation**, for creating unique and chaotic noise effects, and a dedicated 1-pole filter to control noise color.

For standard white noise, set the **Saturation** to 0, and the **Filter Frequency** to 99.

For colored noise (such as pink noise), set the **Saturation** to 0, and reduce the **Filter Frequency** as desired.

To create "speckled noise" such as rocket sounds and thunder, set **Saturation** to 99, and **Filter Frequency** to 10.

To create key contact noise (such as you might find on vintage analog synths), create speckled noise as described above, and then use a fast EG to control its volume in the mixer.

**Saturation** [0...99]

This control clips the noise signal, for added crunch. Subtle variations in saturation are more noticeable with very low **Filter Frequency** settings (see below), allowing you to create organic, rumbling timbres.

**Filter Freq** [0...99]

This is a simple, 1-pole lowpass filter for controlling the "color" of the noise.

**Level** [0...100]

This sets the basic output level of the Noise Generator. It is also shown in the Parameter Details on the Patch Panel.

**EG Select** [None, EG1...EG9, Amp EG]

This selects any of the 10 EGs to control the Noise Generator's output level.

**None** is the same as if the EG was always at its maximum level.

**Noise Generator Parameter Details**

These items appear in the Parameter Details area when any of the Noise Generator parameters are selected.

**AMS Mode** [Add, Multiply]

To calculate the Noise Generator's output volume, the main **Level** parameter and the selected EG are always multiplied together. If either of these is at 0, the other has no effect. For instance, if the **Level** is set to 0, the EG can't bring the volume back up again.

The **AMS Mode** parameter determines how AMS modulation (including Int Mod) interacts with these other controls.

**Add:** AMS is added in after **Level** and the EG are multiplied together. This means that even if one of these other values is at 0, AMS can still bring up the volume to its maximum.

You can also think of this as having parallel modulation paths: the EG on one side, and AMS on the other.

Expressed mathematically, this is:  
Volume = (Level\*EG)+AMS.

**Multiply:** This is the default, and is similar to the way that most other KRONOS Amp modulation works. AMS is multiplied along with the **Level** and the **EG**. If any of these are at 0, the output will be silent.

Expressed mathematically, this is:  
 $Volume = Level * EG * (1 + AMS)$ .

**AMS [List of AMS Sources]**

This selects a modulation source to control the **Level**. For a list of AMS sources, see "Alternate Modulation Source (AMS) List" on page 1091.

**Intensity [-100...+100]**

This controls the depth and direction of the **Level** modulation.

---

**5-1f: EXi Audio Input**

**Important: the audio input is only active when notes are played**

The MOD-7 can process live audio inputs, feedback from effects, or any other audio from within the KRONOS. Note, however, that the audio input is only active when a voice is being played on the MOD-7.

It's easy to make a patch in which only the incoming audio is heard, with the built-in oscillators completely silent—but you still need to press a key (or play a note via MIDI) in order to activate the MOD-7. You can use the EXi Common **Hold** parameter to keep the note "held down" indefinitely, if you like.

**Level [0...100]**

This sets the basic output level of the Audio Input. It is also shown in the Parameter Details on the Patch Panel.

**EXi Audio Input Parameter Details**

These items appear in the Parameter Details area when any of the EXi Audio Input parameters are selected.

**AMS Mode [Add, Multiply]**

The **AMS Mode** parameter determines how AMS modulation interacts with the **Level** parameter.

**Add:** AMS is added to the **Level**. This means that even if the **Level** is set to 0, AMS can still bring up the volume to its maximum.

Expressed mathematically, this is:  
 $Volume = Level + AMS$ .

**Multiply:** This is the default, and is similar to the way that most other KRONOS Amp modulation works. AMS and **Level** are multiplied together.

Expressed mathematically, this is:  
 $Volume = Level * (1 + AMS)$ .

**AMS [List of AMS Sources]**

This selects a modulation source to control the **Level**. For a list of AMS sources, see "Alternate Modulation Source (AMS) List" on page 1091.

**Intensity [-100...+100]**

This controls the depth and direction of the **Level** modulation.

---

**5-1g: Parameter Details**

The Parameter Details area shows information for the selected item, including explanatory graphics and AMS modulation routings.

- Pitch LFO Modulation appears when any of the Pitch LFO parameters are selected.
- Portamento Modulation appears when any of the Portamento parameters are selected.
- VPM Oscillator 1-6 Carrier/Modulator Status appears when any of the Macro Edit parameters are selected.
- Noise Generator Modulation appears when any of the Noise Generator parameters are selected.
- EXi Audio Input Modulation appears when the EXi Audio Input Level parameter is selected.
- The Pitch Slope graphic appears when any of the Pitch parameters are selected.

---

**▼ 5-1: Page Menu Commands**

The number before each command shows its ENTER + number-key shortcut. For more information on these shortcuts, see "ENTER + 0-9: shortcuts for menu commands" on page 147.

- 0: **Write Program.** For more information, see "Write Program" on page 147.
- 1: **Exclusive Solo.** For more information, see "Exclusive Solo" on page 147.

## 5-2: PCM Osc

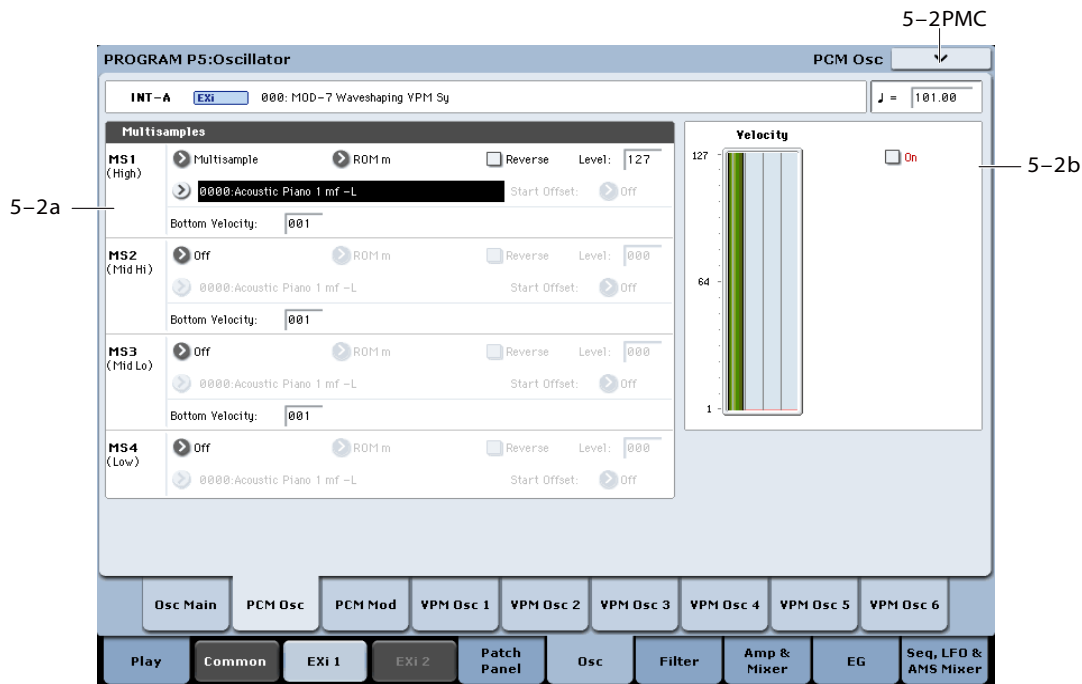

For more information about using PCM in the MOD-7, including hands-on tutorials, see “PCM as a VPM modulator” on page 345, and “Waveshaping” on page 346.

### Overview

#### Disabling the PCM Oscillator

If the PCM Oscillator is not being used, you can disable it to save processing power. You can do this in two ways:

1. Set all MS Type parameters to Off, instead of Multisample.

or:

2. Make sure that the PCM Oscillator is not connected to anything else on the Patch Panel.

This includes both patch cable connections, and the normalised connections of the algorithm. If necessary, select a different algorithm in which the PCM Oscillator is not connected to anything else on the Patch Panel.

### 5-2a: Multisamples

#### Velocity splits

Each Oscillator has four velocity zones, named MS1 (High) through MS4 (Low). Each of these zones can play a different Multisample, and has separate settings for Level, Start Offset, and so on.

Note that, unlike the HD-1, crossfades and layers are not supported.

#### MS1 (High)

These are the settings for the first and highest velocity zone.

If you want to create a simple setup with only a single Multisample, just set up MS1 as desired, and then set the **Bottom Velocity** to 1.

#### Type

[Off, Multisample]

This selects whether MS1 will play a Multisample, or nothing at all. You can use this to disable any of the four Multisamples.

If all four MS are set to Off, the PCM Oscillator will be disabled entirely, saving processing power.

#### Bank

[List of Multisample Banks]

There are four types of Multisample Banks: **ROM, Sampling Mode, EXs, and User Sample Banks.**

**ROM** Multisamples are the built-in “factory” sounds, and are always available.

**Smp (Sampling Mode)** Multisamples are the ones that you can see and edit in Sampling Mode. After the abbreviation “Smp,” several different things may appear, as described below.

**Smp: Old RAM** means that this is an older Program pointing to the legacy “RAM” bank. Instead of pointing to a specific User Sample Bank, it will use whatever Multisample data is loaded into Sampling Mode. Updating to the new format is easy; for more information, see “Converting older sounds” on page 155 of the Operation Guide.

**Smp: New Sampling Session** will appear when there’s data in Sampling Mode which hasn’t yet been saved to disk as a User Sample Bank. For instance, this might happen if you’ve loaded an old KSC file, loaded

individual Samples or Multisamples, or recorded some new samples. Once the KSC is saved to disk, the name will update to show the file path (as described below).

**Smp:** [file name] will appear when a User Sample Bank has been loaded into Sampling Mode. The name is the file name itself along with those of all its enclosing folders.

**EXs** Multisample banks are PCM expansion sets created especially for the KRONOS. Each has its own unique number; for instance, the ROM Expansion is EXs1, and the Concert Grand Piano expansion is EXs2. Only the currently loaded EXs banks will appear on this menu.

**User Sample Banks** bring the benefits of EXs to your own sample libraries. You can load and play gigabytes of your custom or converted samples at once, using Virtual Memory. The name is shown as a path to the KSC file, including the file name and the names of all enclosing directories. Only the currently loaded User Sample Banks will appear in this menu.

If a sound refers to a User Sample Bank which is not on the internal drive(s), the name will appear as “Unknown Sample Bank [number]” when the bank select dialog is open, shortened to “??[number]” when the dialog is closed.

For more information, see “User Sample Banks” on page 154 of the Operation Guide.

 Note that unlike the HD-1, you can only select mono Multisamples.

**Multisample Select** [List]

This parameter lets you select a Multisample for the velocity zone. You can use any mono Multisample, or the left or right channel of a stereo Multisample.

 Some Multisamples may have an upper limit to their keyboard range, over which they may not produce any sound.

*Note:* if the stored selection uses an EXs sample which is not currently loaded, it will not make any sound. As an indication of this, the name will be shown in red. The message “Samples Not Loaded” will also appear at the top of the display. To fix this, load the required EXs sample data.

**Multisample Select menu**

To select a Multisample:

1. Press the **Multisample Select popup button to open the Multisample select menu.**
2. Use the tabs to select a category and sub-category.
3. Select a Multisample from within that category/sub-category.
4. Press the **OK button to confirm your selection, or press the Cancel button to exit without making a change.**

The list shows all of the mono Multisamples in the Bank. If the Bank contains stereo multisamples, you’ll also see the left and right channels as separate, mono multisamples, with -L and -R appended to the end of the name.

**Reverse** [Off, On]

This lets you play the selected multisample backwards, without looping.

*Note:* If the individual samples within a Multisample are already set to Reverse, they will still play in reverse, regardless of this setting.

*Note:* Reverse is not available for EXs Multisamples loaded using Virtual Memory. To use reverse with EXs data, set the Load Method to RAM. For more information, see “Change load method” on page 766.

**On (checked):** The Multisample will play back in reverse.

**Off (unchecked):** The Multisample will play back normally.

**Level** [0...127]

This sets the basic volume level of each multisample. Use this to adjust the balance between the four velocity zones.

 Depending on the multisample, high **Level** settings may cause distortion when playing many notes at a time. If this occurs, lower the **Level**.

With Sampling Mode Multisamples, each Sample also has a **+12dB** option. If this is turned on, the Sample will play back approximately 12dB louder. You can configure this parameter for each Sample in Sampling mode. For more information, see “+12dB” on page 701.

**Start Offset** [Off, 1st...8th]

In addition to simply starting playback from the beginning, ROM and EXs Multisamples can have up to 8 different pre-programmed alternate starting points.

Similarly, Sampling Mode and User Sample Bank Multisamples can play either from the beginning of the waveform, or from the loop start point.

**Start Offsets: ROM and EXs**

With ROM and EXs Multisamples, the Start Offset specifies whether to use the normal start point (**Off**), or to use one of the alternate start points (**1st–8th**).

Some ROM and EXs Multisamples may have fewer than 8 pre-programmed points, in which case only the available points can be selected.

**Start Offsets: Sampling Mode and User Sample Banks**

With Sampling Mode and User Sample Bank Multisamples, only **Off** and **1st** are available. **Off** uses the normal start point, and **1st** uses the loop start instead. **2nd** through **8th** will be grayed out.

**Bottom Velocity** [1...127]

This sets the lowest velocity at which the Multisample or will sound. MS1’s Bottom Velocity can be equal to, but not lower than, than that of MS2.

**MS2 (Mid Hi), MS3 (Mid Lo), and MS4 (Low)**

These are the settings for the second, third, and fourth velocity zones. The parameters for MS2 and MS3 are exactly the same as those for “MS1 (High),” above.



The parameters for MS4 are also similar to those for MS1, except that MS4 has no setting for Bottom Velocity (which is always fixed at 1).

### 5-2b: Velocity Graphic

#### Velocity zone graphic

This is a graphic representation of the velocity zones for MS1-4. The currently selected MS is shown in green.

#### On [Checkbox]

This mutes and un-mutes the PCM Oscillator, for quick comparisons during editing. This checkbox is also shown in the Parameter Details on the Patch Panel.

Note that the PCM Oscillator will still use processing power unless it is not connected on the Patch Panel, or all MS are set to **Off**. For more information, see "Disabling the PCM Oscillator" on page 360.

### ▼ 5-2: Page Menu Commands

The number before each command shows its ENTER + number-key shortcut. For more information on these shortcuts, see "ENTER + 0-9: shortcuts for menu commands" on page 147.

- **0: Write Program.** For more information, see "Write Program" on page 147.
- **1: Exclusive Solo.** For more information, see "Exclusive Solo" on page 147.
- **2: Copy VPM Oscillator.** For more information, see "Copy VPM Oscillator" on page 386.
- **3: Swap VPM Oscillators.** For more information, see "Swap VPM Oscillators" on page 386.
- **4: Remap MS/Sample Banks.** For more information, see "Remap MS/Sample Banks" on page 163.

### 5-3: PCM Mod

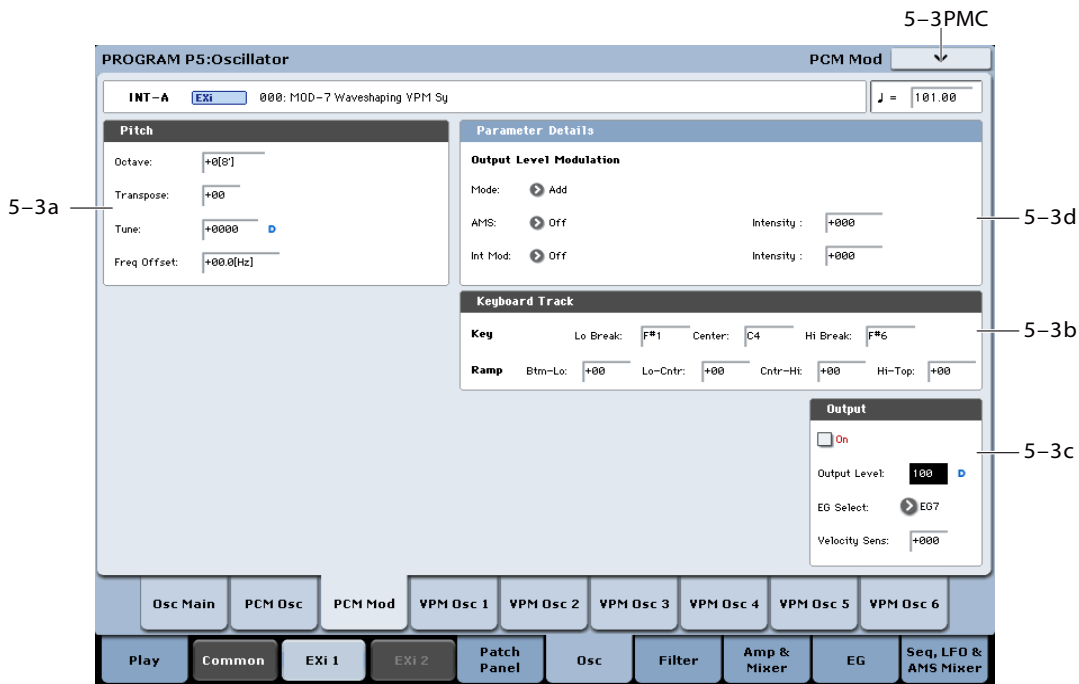

This page provides control of pitch and volume settings and modulation for the PCM Oscillator.

#### 5-3a: Pitch

##### Octave [-2[32'], -1[16'], +0[8'], +1[4']]

This sets the basic pitch of the PCM Oscillator, in octaves. The default is +0[8].

##### Transpose [-12...+12]

This adjusts the pitch in semitones, over a range of ±1 octave.

##### Tune [-1200...+1200]

This adjusts the pitch in cents, over a range of ±1 octave. A cent is 1/100 of a semitone.

##### Frequency Offset [-10.0Hz...+10.0Hz]

This adjusts the pitch by increments of 0.1 Hz. **Frequency Offset** is different from **Tune** in that, when used to detune the two oscillators, it can create a constant beat frequency across the range of the keyboard.

#### Pitch Parameter Details

These items appear in the Parameter Details area when any of the Pitch parameters are selected.

#### Use Common Mod [Checkbox]

When off, the oscillator still responds to the **Pitch** and **Portamento** settings from Pitch Common, but ignores the **LFO** and **AMS** settings.

**AMS1 [List of AMS Sources]**

This selects the first modulation source for controlling the oscillator’s pitch. For a list of AMS sources, see “Alternate Modulation Source (AMS) List” on page 1091.

**Intensity [-48.00...0.00...+48.00]**

This controls the depth and direction of the AMS 1 pitch modulation, in semitones. To easily convert from semitones to FM ratios, see the table below.

Ratio	Pitch in semitones
1	Root pitch
2	+12.00
3	+19.01
4	+24.00
5	+27.83
6	+31.03
7	+33.44 -- 2 octaves + minor seventh (-56 cents)
8	+36.00
9	+38.09 -- 3 octaves + whole tone (+9 cents)
10	+ 39.65 -- 3 octaves + major third (-35 cents)
12	+43.06 -- 3 octaves + fifth (+6 cents)
15	+46.50 -- 3 octaves + major seventh (-50 cents)
16	+48.00

**AMS1 Int. Mod [List of AMS Sources]**

You can modulate AMS 1’s Intensity from another AMS source. This selects that source.

**Intensity [-48.00...0.00...+48.00]**

This controls the depth and direction of the Intensity Mod AMS, in semitones. The result is summed with the main AMS 1 Intensity to produce the final pitch modulation amount.

**AMS2 [List of AMS Sources]**

This selects a second modulation source for controlling the oscillator’s pitch. For a list of AMS sources, see “Alternate Modulation Source (AMS) List” on page 1091.

**Intensity [-48.00...0.00...+48.00]**

This controls the depth and direction of the AMS 2 pitch modulation, in semitones.

**5–3b: Keyboard Track**

The PCM Oscillator has its own keyboard tracking, which is dedicated to modulating the **Output Level** as you play up and down the keyboard. This can be especially convenient when using PCM as a modulator for a VPM Oscillator.

For more details on these parameters, see “5–4d: Keyboard Track” on page 372.

**How it works: Keys and Ramps**

The keyboard tracking works by creating four ramps, or slopes, between five keys on the keyboard. The bottom and top keys are fixed at the bottom and top of

the MIDI range, respectively. You can set the other three keys—named **Low Break**, **Center**, and **High Break**—to be anywhere in between.

The four ramp values control the rate of change between each pair of keys. For instance, if the **Low-Center Ramp** is set to 0, the value will stay the same between the **Low Break** key and the **Center** key.

You can think of the resulting shape as being like two folding doors attached to a hinge in the center. At the **Center** key (the main hinge), the keyboard tracking has no effect. The two folding doors swing out from this center point to create changes in the higher and lower ranges of the keyboard.

**Key**

**Low Break [C–1...G9]**

This sets the breakpoint note between the two lower ramps—the “hinge” of the lower door.

**Center [C–1...G9]**

This sets the center of the keyboard tracking—the main “hinge.” At this key, the keyboard tracking has no effect on the volume, or on any AMS destinations.

**High Break [C–1...G9]**

This sets the breakpoint note between the two higher ramps—the “hinge” of the upper door.

**Entering notes from the keyboard**

You can enter note numbers directly by playing them on the keyboard. To do so:

1. Select one of the **Key** parameters.
2. Hold down the **ENTER** key.
3. While holding **ENTER**, play a note on the keyboard.

**Ramp**

**Bottom-Low [-Inf, -99...+99, +Inf]**

This sets the slope between the bottom of the MIDI note range and the **Low Break** key. For normal key track, use negative values.

**Low-Center [-Inf, -99...+99, +Inf]**

This sets the slope between the **Low Break** and **Center** keys. For normal key track, use negative values.

**Center-High [-Inf, -99...+99, +Inf]**

This sets the slope between the **Center** and **High Break** keys. For normal key track, use positive values.

**High-Top [-Inf, -99...+99, +Inf]**

This sets the slope between the **High Break** key and the top of the MIDI note range. For normal key track, use positive values.

Ramp	Change in level
-Inf	Silent in one half-step
-99	Silent in one whole-step
-95	Silent in one octave
-48	Silent in two octaves
-25	Silent in four octaves

Ramp	Change in level
00	no change
+25	x2 in four octaves
+50	x2 in two octaves
+99	x2 in one octave
+Inf	x2 in one half-step

**Keyboard Track Parameter Details**

The **Keyboard Track** graphic appears in the Parameter Details area when any of the Keyboard Track parameters are selected.

**5-3c: Output**

These parameters control the overall volume of the PCM Oscillator.

**On** **[Checkbox]**

This mutes and un-mutes the entire oscillator, for quick comparisons during editing. This parameter is also shown in the Parameter Details on the Patch Panel.

Note that the oscillator will still use processing power unless either all MS are set to Off, or the PCM Oscillator is not connected to anything on the Patch Panel. For more information, see "Disabling the PCM Oscillator" on page 360.

**Output Level** **[0...100]**

This sets the basic output level of the VPM Oscillator. It is also shown in the Parameter Details on the Patch Panel.

**EG Select** **[None, EG1...EG9, Amp EG]**

This selects any of the 10 EGs to control the Oscillator's output level. By default, EGs 1-6 are assigned to VPM Oscillators 1-6, EG7 is assigned to the PCM Oscillator, and EG8 is assigned to Filter A Cutoff.

**None** is the same as if the EG was always at its maximum level.

**Velocity Sens** **[-100...+100]**

This controls the degree to which output level responds to velocity. Negative settings are useful for creating velocity crossfades.

**Output Level Parameter Details**

These items appear in the Parameter Details area when any of the parameters in the Output section are selected. This includes **On**, **Output Level**, **EG Select**, and **Velocity Sens**.

**AMS Mode** **[Add, Multiply]**

To calculate the PCM Oscillator's output volume, the main **Level** parameter, **Velocity Sens**, **Key Tracking**, and the selected **EG** are always multiplied together. If the value of any of these is at 0, none of the others has any effect. For instance, if the selected **EG** falls to 0, **Key Tracking** can't bring the level back up again.

The **AMS Mode** parameter determines how AMS modulation (including Int Mod) interacts with these other modulators.

**Add:** AMS is added in after **Level**, **Velocity Sens**, **Key Tracking**, and the EG are multiplied together. This means that even if one of the main values is at 0, AMS can still bring up the volume to its maximum.

You can also think of this as having parallel modulation paths: EG, Key Track, and Velocity Sensitivity on one side, and AMS on the other.

Expressed mathematically, this is:  
 $Volume = (Level * EG * Key Track * Vel Sens) + AMS$ .

**Multiply:** This is the default, and is similar to the way that most other KRONOS Amp modulation works. AMS is multiplied along with all of the other modulators.

Expressed mathematically, this is:  
 $Volume = Level * EG * Key Track * Vel Sens * (1 + AMS)$ .

**AMS** **[List of AMS Sources]**

This selects the main modulation source for controlling the **Output Level**. For a list of AMS sources, see "Alternate Modulation Source (AMS) List" on page 1091.

**Intensity** **[-100...+100]**

This controls the depth and direction of the **Output Level** modulation.

**AMS Int. Mod** **[List of AMS Sources]**

You can modulate the AMS Intensity from another AMS source. This selects that source.

**Intensity** **[-100...+100]**

This controls the depth and direction of the Intensity Mod AMS. The result is summed with the main AMS 1 Intensity to produce the final **Output Level** modulation amount.

**5-3d: Parameter Details**

The Parameter Details area shows information for the selected item, including explanatory graphics and AMS modulation routings.

- Pitch Modulation appears when any of the Pitch parameters are selected.
- The **Keyboard Track** graphic appears in the Parameter Details area when any of the Keyboard Track parameters are selected.
- Output Level Modulation appears when any of the Output parameters are selected.

**▼ 5-3: Page Menu Commands**

The number before each command shows its ENTER + number-key shortcut. For more information on these shortcuts, see "ENTER + 0-9: shortcuts for menu commands" on page 147.

- 0: **Write Program**. For more information, see "Write Program" on page 147.
- 1: **Exclusive Solo**. For more information, see "Exclusive Solo" on page 147.
- 2: **Copy VPM Oscillator**. For more information, see "Copy VPM Oscillator" on page 386.

- 3: Swap VPM Oscillators. For more information, see “Swap VPM Oscillators” on page 386.

## 5-4: VPM Osc1

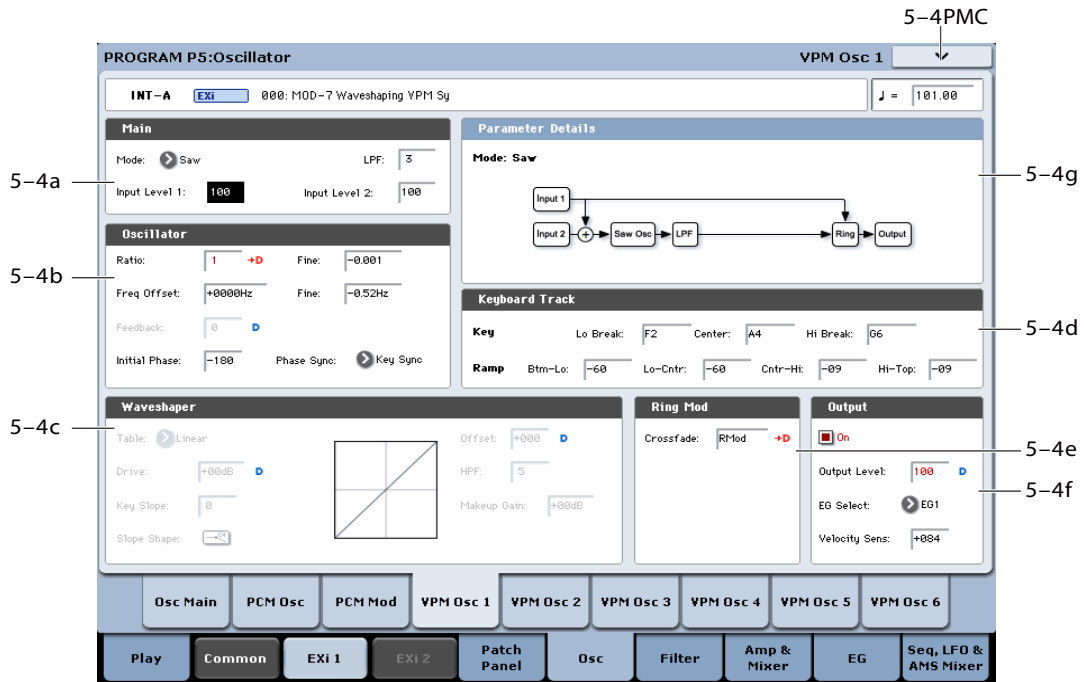

The six VPM Oscillators are the main tools of the MOD-7, and can be used in various ways for both generating waveforms and processing audio. For general information about these different possibilities, please see “Synthesis with the MOD-7: a guided tour” on page 341.

This page controls all aspects of the VPM Oscillator, including:

- Whether it will function as an oscillator on its own, or as a waveshaper or ring modulator for other signals
- All FM-related controls, including input levels, oscillator phase, feedback, and ratio, along with modulation for feedback and pitch
- All waveshaping-related controls, including table selection, drive, offset, keyboard slope, and modulation for drive and offset
- Ring mod crossfade modulation
- Output level and modulation, including keyboard tracking, EG selection, and velocity sensitivity

### 5-4a: Main

**Mode** [Off, Sine, Saw, Triangle, Square, Sine + Waveshaper, Waveshaper, Ring Mod Only]

This selects the basic functionality of the VPM Oscillator. Depending on the selected Mode, other parameters in the VPM Oscillator may be grayed out.

The Mode also affects the required processing power. **Triangle, Square, and Sine + Waveshaper** need the most power, and using them may result in slightly lower polyphony. **Off** requires no processing power at all.

**Off:** This completely disables the VPM Oscillator. If you’re not using the VPM Oscillator at all, set its **Mode** to **Off** in order to save processing power.

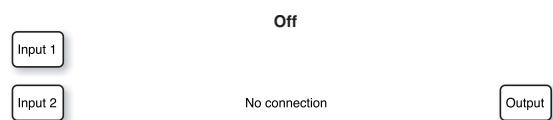

**Sine:** This includes a sine oscillator followed by a one-pole lowpass filter and a ring modulator. **Sine** is the default setting, used for classic FM sounds. Even when using more complex waveforms for FM Modulators, **Sine** is still the normal setting for an FM Carrier.

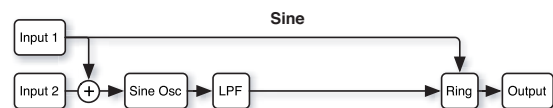

**Saw:** This mode uses FM feedback to create a sawtooth waveform. As with Sine, it includes a one-pole lowpass filter after the oscillator, as well as a ring modulator.

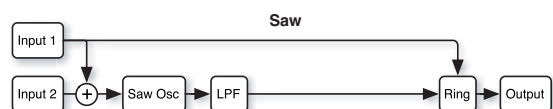

**Triangle:** This mode uses the oscillator to create a triangle waveform, followed by the ring modulator.

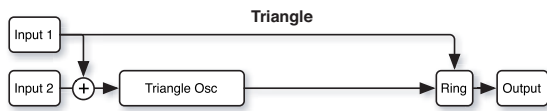

**Square:** This mode uses the oscillator to create a square waveform. There's still a ring modulator before the output.

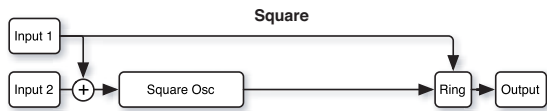

**Sine + Waveshaper:** This is the ultra-super-deluxe mode: sine oscillator, waveshaper, lowpass and highpass filters, and ring modulator. Three scoops, hot fudge sauce, whipped cream, chopped nuts, and a cherry on top.

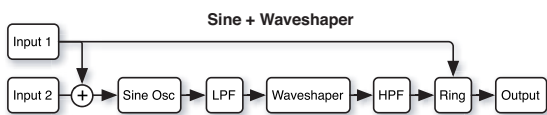

**Waveshaper:** This mode lets you use the waveshaper section to process signals from other sources, such as the other VPM Oscillators, the PCM Oscillator, the audio input, and so on. It includes a one-pole highpass filter after the waveshaper, followed by a ring modulator. Note that this setting disables the internal oscillator.

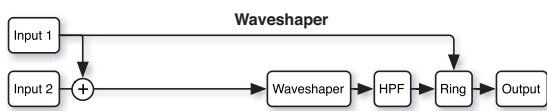

**Ring Mod Only:** In this mode, as the name implies, only the Ring Modulator is active. Input levels have no effect. Input 1 is the Modulator, and Input 2 is the Carrier.

Note: this setting disables the sine oscillator. Use this setting only if you want to use external signals for both the Modulator and the Carrier. If you want to use the internal sine oscillator as the Carrier, set **Mode** to **Sine** instead.

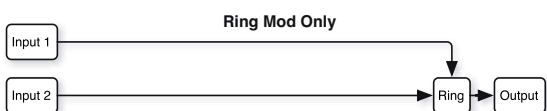

**LPF [0...100]**

This is a one-pole lowpass filter positioned directly after the Sine or Saw oscillators. It is available only when **Mode** is set to **Sine**, **Saw**, or **Sine + Waveshaper**.

**Input Level 1 [0...100]**

This sets the level for the first input. The level applies to both FM and Waveshaping, but it does not affect the direct path from Input 1 to the Ring Modulator.

When **Mode** is set to **Sine**, **Saw**, **Triangle**, **Square**, or **Sine + Waveshaper**, this controls the intensity of the FM from this input.

When **Mode** is set to **Waveshaper**, this controls the basic level going into the Waveshaper, which can be further controlled via the **Drive** parameter.

When **Mode** is set to **Ring Mod Only**, the input level has no effect.

**Input Level 2 [0...100]**

This sets the level for the second input, similar to "LPE," above.

When **Mode** is set to **Ring Mod Only**, the input level has no effect.

**Mode Parameter Details**

A diagram of the selected **Mode's** signal flow appears in the Parameter Details area when any of the Main parameters are selected.

**5-4b: Oscillator**

The Oscillator parameters do not apply when the **Mode** is set to **Off**, **Waveshaper**, or **Ring Mod Only**.

For more information about using the oscillator for VPM/FM, including hands-on tutorials, see "VPM (aka FM)" on page 343.

**Ratio [0...64]**

This sets the basic tuning for the oscillator. You can create in-between settings (including 0.5) by using **Fine**, below.

0 means that the pitch will not change in response to the note number. For the classic DX "fixed frequency" effect, set both **Ratio** and **Ratio Fine** to 0, and then set the **Frequency Offset** and **Frequency Fine** to the desired frequency. Note that with these settings, pitch modulation will have no effect.

1 produces the standard root pitch.

2 produces the first harmonic, 3 the second harmonic, and so on. For more information, see "VPM and FM Synthesis" on page 341.

**Tip: Carrier Ratio near 0 produces chorusing**

In an FM pair, setting the Carrier's **Ratio** and **Frequency Offset** close to 0 reverses the normal relationship between the Carrier and the Modulator. In this case, the Modulator's timbre comes through very clearly, while the Carrier provides only a chorusing effect. Use **Ratio Fine** and/or **Frequency Offset Fine** to control the speed and depth of the chorus.

**(Ratio) Fine [-0.999...0...+0.999]**

This allows you to fine-tune the ratio. You can think of this as the digits to the right of the decimal. For instance, setting the **Ratio** to 0 and **Fine** to +0.500 results in an actual ratio of 0.5, for a pitch one octave lower than standard.

**Frequency Offset [-9999...0000...+9999Hz]**

This produces a static frequency offset, in Hertz, from the pitch set by Ratio.

**(Frequency) Fine [-0.99...+0.99 Hz]**

This adjusts the **Frequency Offset** in 1/100 Hz increments.

**Initial Phase** [-180...0...+180]

This sets the initial phase of the oscillator. The relative phases of the carrier and modulator will affect the sound of FM modulation.

**Tip:** Try creating a simple FM pair, with the carrier's **Ratio** set to 0, and the modulator's **Ratio** set to 1. Set the carrier's **Initial Phase** to +90, and then listen to how the sound changes when you move this up or down by a few degrees. The sound is similar to an electric piano.

**Phase Sync** [Key Sync, Random, Free Run]

**Key Sync** sets the oscillator to the **Initial Phase** value at every key down.

**Random** sets the oscillator to a random value, with the value randomized per oscillator. (This is the same as the AL-1 behavior for random.)

**Free Run** sets the oscillator to **Initial Phase** plus a random value that is the same for all of the EXi's voices, and for all of the VPM Oscillators within those voices. For instance, if a Program has two MOD-7s, the voices for EXi1 would have one random value, and those for EXi2 would have another. To get the vintage DX7 behavior, set oscillators to **Free Run** and set their phase to 0.

**Feedback** [0...100]

**Feedback** is a third FM input, hard-wired in one of two ways to the oscillator's own output, which allows the oscillator to modulate itself. The exact routing depends on the **Feedback Path** parameter; for more information, see "Feedback Path" on page 367.

**Feedback** is available only when **Mode** is set to **Sine** or **Sine + Waveshaper**.

With **Feedback Path** set to **From Sine Osc**, setting **Feedback** to 65 creates a reasonable approximation of a sawtooth waveform. Modulation of **Feedback** will then sound similar to modulating the cutoff frequency of a low-pass filter.

**Pitch Parameter Details**

These items appear in the Parameter Details area when **Ratio**, (**Ratio**) **Fine**, **Freq Offset**, (**Freq Offset**) **Fine**, **Initial Phase**, or **Phase Sync** are selected.

**Note:** when both **Ratio** and **Ratio Fine** are set to 0, pitch modulation will have no effect.

**Use Common Mod** [Checkbox]

**On:** The oscillator will respond to all of the pitch modulation from the Osc Main page. This the default.

**Off:** The oscillator will ignore the Osc Main page's **LFO** and **AMS** settings. It will still respond to the **Pitch** and **Portamento** settings, including **Pitch Slope**, **JS (+X)**, **JS(-X)**, **Ribbon**, and **Analog**. It will also respond to all pitch-related EXi Common parameters, such as **Chord** and **Scale**.

**AMS1** [List of AMS Sources]

This selects the first modulation source for controlling the oscillator's pitch. For a list of AMS sources, see "Alternate Modulation Source (AMS) List" on page 1091.

**Intensity** [-48.00...0.00...+48.00]

This controls the depth and direction of the AMS 1 pitch modulation, in semitones. To easily convert from semitones to FM ratios, see the table below.

Ratio	Pitch in semitones
1	Root pitch
2	+12.00
3	+19.01
4	+24.00
5	+27.83
6	+31.03
7	+33.44 -- 2 octaves + minor seventh (-56 cents)
8	+36.00
9	+38.09 -- 3 octaves + whole tone (+9 cents)
10	+ 39.65 -- 3 octaves + major third (-35 cents)
12	+43.06 -- 3 octaves + fifth (+6 cents)
15	+46.50 -- 3 octaves + major seventh (-50 cents)
16	+48.00

**AMS1 Int. Mod** [List of AMS Sources]

You can modulate AMS 1's Intensity from another AMS source. This selects that source.

**Intensity** [-48.00...0.00...+48.00]

This controls the depth and direction of the Intensity Mod AMS, in semitones. The result is summed with the main AMS 1 Intensity to produce the final pitch modulation amount.

**AMS2** [List of AMS Sources]

This selects a second modulation source for controlling the oscillator's pitch. For a list of AMS sources, see "Alternate Modulation Source (AMS) List" on page 1091.

**Intensity** [-48.00...0.00...+48.00]

This controls the depth and direction of the AMS 2 pitch modulation, in semitones.

**Feedback Parameter Details**

These items appear in the Parameter Details area when **Feedback** is selected.

**Feedback Path** [From Sine Osc, From Output]

This controls the source of the **Feedback** signal.

**From Sine Osc** routes the feedback directly from the output of the Sine Oscillator. The rest of the VPM Oscillator signal chain, including the LPF, HPF, Waveshaper, ring modulator, and output volume control, will not affect the feedback. Use this option when you want the feedback timbre to be independent from the output volume.

**From Output** routes the feedback from the output of the entire VPM Oscillator signal chain. When the Oscillator Mode is set to Sine, this produces the feedback structure of classic FM synths.

Feedback Path

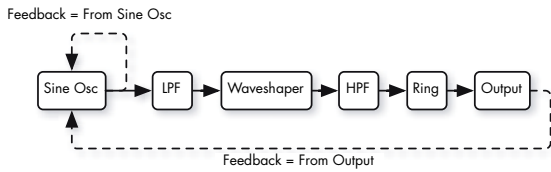

AMS

[List of AMS Sources]

This selects an AMS source to control the Feedback. For a list of AMS sources, see "Alternate Modulation Source (AMS) List" on page 1091.

Intensity

[-100...+100]

This controls the depth and direction of the AMS modulation for Feedback.

5-4c: Waveshaper

This section is available only when the Mode is set to Sine + Waveshaper or Waveshaper.

Note that, if the same oscillator is using both FM and waveshaping, they occur in that order: first the sine oscillator is modulated by the inputs, and then the result is waveshaped.

For more information about using the waveshaper, including hands-on tutorials, see "Waveshaping" on page 346.

Table

[List of tables]

This selects the table used by the waveshaper. The waveshaping effect will be a combination of the input signal (including both the waveform and the signal level), the selected table, and the settings for Drive and Offset.

Linear, Sine->Tri, and Step

**Linear:** This simple table does not alter the signal, as long as levels are within the range of the table. Extremely high input levels, or Drive settings over 0dB, may still cause clipping. Non-zero values of Offset may also cause clipping on either the positive or negative side, changing the waveform's symmetry.

**Sine->Tri:** With full-scale sine input, this table creates a triangle waveform. If you just want to create a triangle waveform, setting the Mode to Triangle will work a little better, but this table allows you to use Drive and Offset in creative ways.

For a basic triangle waveform, set the Key Slope to 1, and set the Key Slope Mode to roll off only above C4. For more mellow, sine-like tones, reduce the Drive; for sharper timbres, increase it.

**Step:** This table creates soft clipping. Increasing the input level and/or Drive creates harder clipping.

With a full-scale sine wave, the output is something like a soft square wave, with Offset being similar to pulse width.

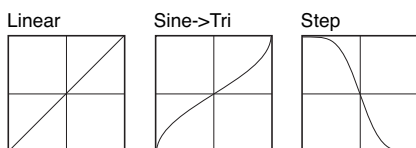

Sines

With sine wave input, these tables produce output similar to a simple FM pair with the Carrier:Modulator ratio set to 0:1. Drive functions like the FM input level, and responds well to AMS modulation. With full-scale input, Drive settings over 0dB will cause clipping.

The tables differ only in their maximum brightness. Sine4 is the brightest, for the broadest range of timbres. Sine2 is darker, and Sine is darker still; these offer finer control with Drive modulation, for more subtle coloration.

**Sine4:** When Drive is at 0dB, this table is like 0:1 FM with the carrier level at maximum. To produce a similar effect to Sine2, reduce the Drive by 6dB; to produce a similar effect to Sine, reduce the Drive by 12dB.

**Sine and Sine2:** These are darker versions of Sine4.

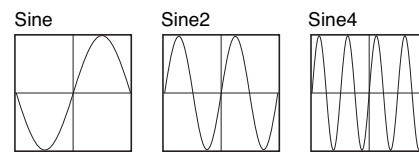

Pickups

These tables simulate electromagnetic pickups, such as those of an electric piano. Drive functions as the signal gain.

To create electric piano sounds, use a sine wave as input, and assign an EG to modulate Drive; it should be around 0dB at first, and then decay exponentially to a very low value. Offset controls the distance between the pickup and the center of the tine; typically, values close to 0 will work well.

**Pickup1:** This simulates a bright electromagnetic pickup.

**Pickup2:** This creates a different amount of saturation; its tone is slightly darker than Pickup1.

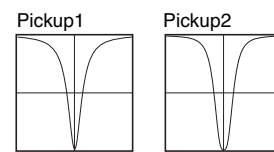

Tanh

**Tanh2, 4, and 8:** These create soft clipping, similar to the Step. Vary the Drive to control the amount of distortion. 2, 4, and 8 produce increasing amounts of clipping. Full-scale sine wave input will produce output similar to a soft-edged square wave.

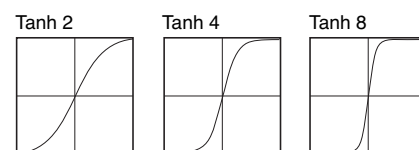

Additive

While the Additive tables can produce interesting results with any input signal, they produce the described results only with a full-scale sine wave. Reducing the Drive (or the level of the sine wave input) will diminish the level of the additive



harmonics, making the result sound more like the original sine. Dynamic modulation of Drive may sound similar to a filter opening and closing.

**Add Saw 3Harm:** This produces the first three harmonics of a sawtooth.

**Add Square 3Harm:** This produces the first three harmonics of a square wave.

**Add Tri 3Harm:** This produces the first three harmonics of a triangle wave.

**Add 12345:** This produces harmonics 1 through 5 with equal amplitude, similar to a filtered pulse waveform.

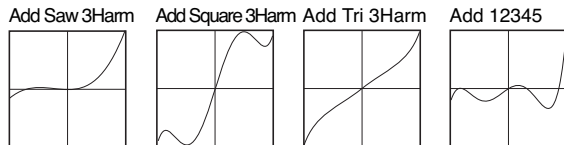

**Add 1Plus2:** This produces the fundamental plus the 2nd harmonic at equal amplitude, and sounds like an 8' + 4' organ stop.

**Add 1Plus3:** This produces the fundamental plus the 3rd harmonic at equal amplitude, and sounds like an 8' + 2 2/3' organ stop.

**Add 1Plus4:** This produces the fundamental plus the 4th harmonic at equal amplitude, and sounds like an 8' + 2' organ stop.

**Add 1Plus5:** This produces the fundamental plus the 5th harmonic at equal amplitude, and sounds like an 8' + 1 3/5' organ stop.

**Add 1Plus6:** This produces the fundamental plus the 6th harmonic at equal amplitude, and sounds like an 8' + 1 1/3' organ stop.

**Add 1Plus7:** This produces the fundamental plus the 7th harmonic at equal amplitude.

**Add 1Plus8:** This produces the fundamental plus the 8th harmonic at equal amplitude, and sounds like an 8' + 1' organ stop.

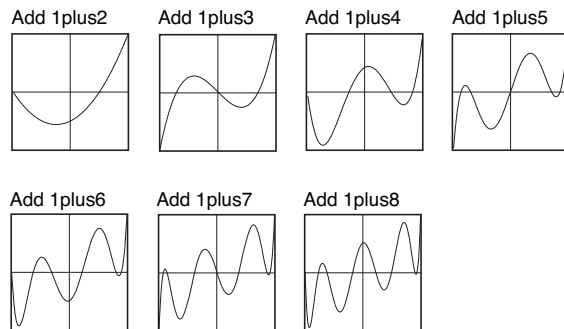

**Multipliers**

**Sine Octave:** With full-scale sine input, this produces a sine wave one octave higher than the input, and clips above 0 dB.

**Sine 2Octave:** With full-scale sine input, this produces a sine wave two octaves higher than the input signal. With decreasing Drive settings, it jumps down to the original octave—producing an interesting effect when Drive is modulated. More complex input signals can also produce good results.

**Triangle4:** This is similar to Sine4, except that it uses a triangle shape. It produces output similar to a simple FM pair with the Carrier:Modulator ratio set to 0:1, and the carrier set to a triangle wave. Drive functions like the FM input level, and responds well to AMS modulation. With full-scale input, Drive settings over 0dB will cause clipping.

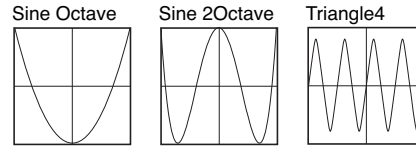

**TX Waves**

**TX Wave 2, 3, 4, 7, and 8:** With full-scale sine input, these produce waveforms similar to those of classic 4-operator FM synths. Modulate Drive below 0dB for a more sine-like sound.

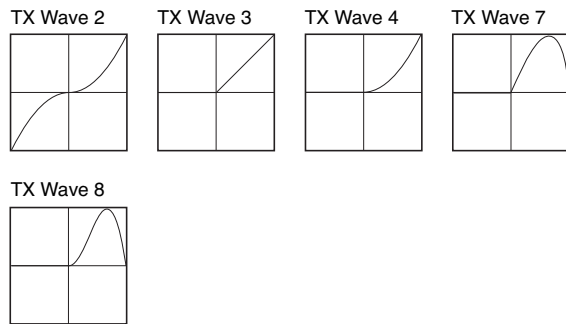

**Tube and Diode**

**Tube:** This is a soft-clipping table, for simulating analog saturation. The combination of input level and Drive controls the amount of clipping; Offset controls symmetry, like DC offset into a VCA.

**Diode 1 and 2:** These produce asymmetric soft-clipping, like an analog diode. Diode 2 produces more distortion than Diode 1.

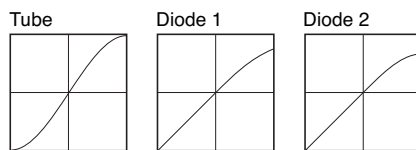

**Mixture**

**Mixture 1, 2, 3, and 4:** With sine wave input, these four tables create a bunch of different harmonics at different amplitudes, like FM or organ stops.

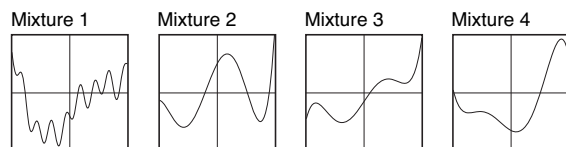

**Invert**

**Invert:** This table simply inverts the input signal. It can be used to invert a waveform prior to adding it back to itself—for pulse width modulation, for example.

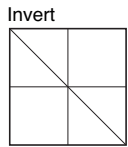

**Fuzzy**

**Fuzzy:** This table adds random-sounding noise to the input, even with low input levels. Modulating **Drive** can produce interesting, grungy effects.

**Fuzzy Tube:** This is similar to **Fuzzy**, above, with the addition of soft clipping.

**Get Fuzzy:** This unusual table is noisy only around zero. High-level input signals (or high **Drive** settings) will produce less noisy output, while low-level signals will be much more noisy.

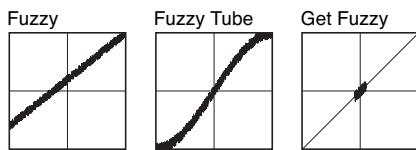

**01/W and Waveshaper Effect tables**

The rest of the tables are based on those of the classic Korg 01/W and the Waveshaper effect.

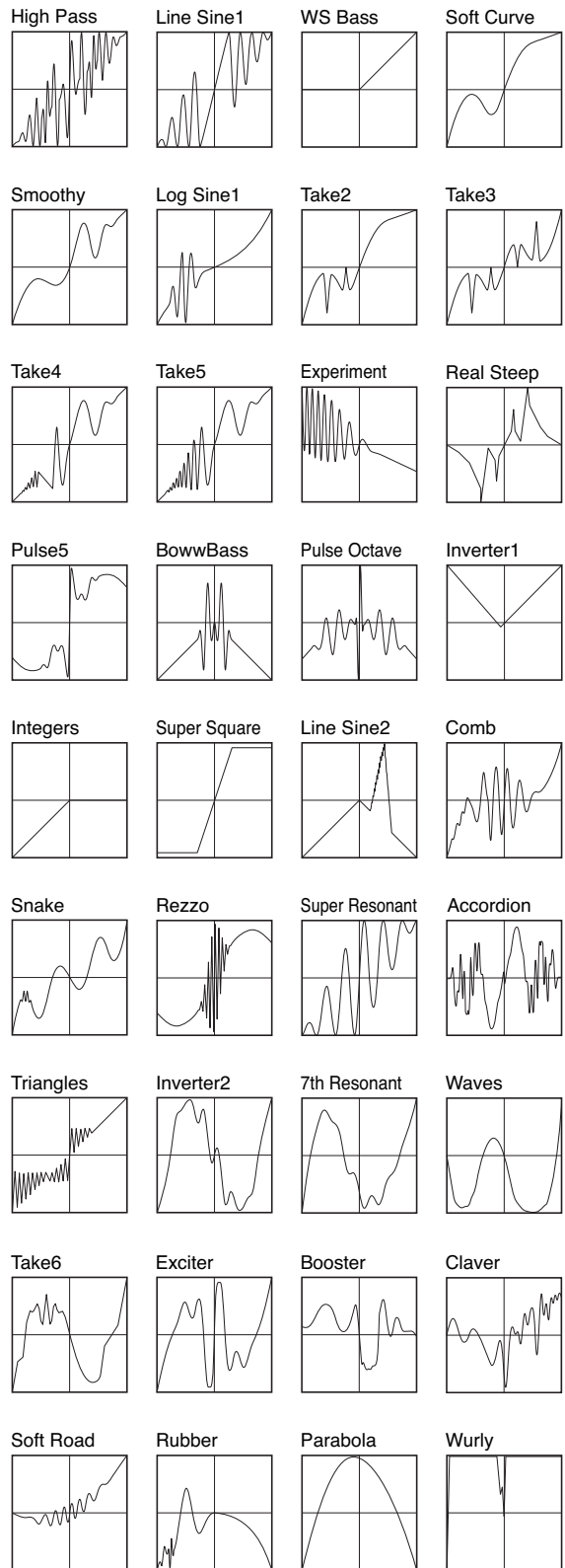
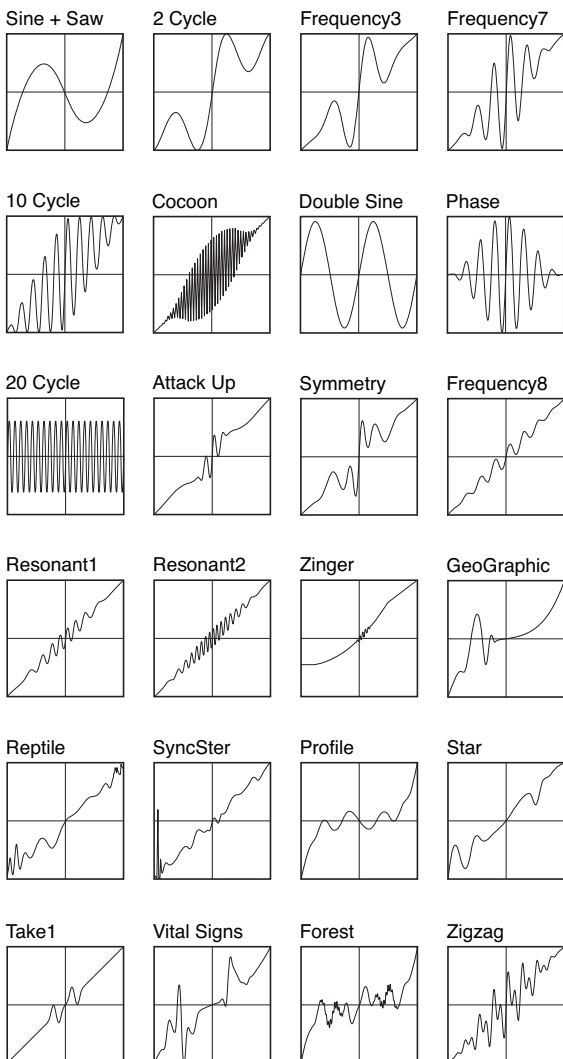

**Drive**

**[-36dB...0dB...+36dB]**

This sets the volume of the signal going into waveshaper. By reducing the **Drive**, you can make the signal interact with only part of the table. This is particularly useful in combination with **Offset**, as shown in the diagram below. **Drive** can also be modulated to create changes in timbre, as described under "Tip: Modulating Drive," below.

With a pure sine oscillator, anything greater than 0dB will clip. Often, clipping will sound bad—but some tables, such as **tanh**, **step**, **tube** and **diode**, are specifically made for clipping. With these tables, the harder you drive, the more saturation/overdrive you'll get.

*Drive and Offset*

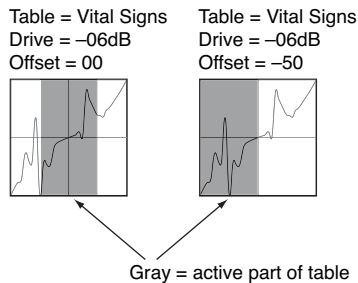

**Key Slope** [0...75]

This scales the amount of **Drive** as you move up and down the keyboard, with a center point of C4. **Key Slope** can help to keep the timbre even across the keyboard, and also help to minimize aliasing. The **Slope Shape** parameter, below, affects how this parameter works.

The steps are in increments of 0.2dB per octave, up to a maximum of 15dB/oct.

**Slope Shape** [graphics: symmetric, high range only]

**Key Slope** always attenuates **Drive** above C4. This parameter selects whether or not it also *boosts Drive* below C4.

**Offset** [0...100]

This introduces a DC Offset into the input signal, shifting the signal in relation to the waveshaper table.

With a full-scale input signal, this will make the signal clip on one side or the other, and result in an asymmetric waveform. When used in conjunction with **Drive**, it can select the part of the table used to process the signal. **Offset** can be modulated at note-on, which works well with AMS sources such as Velocity and Exponential Velocity.

Offset also has specific uses with particular tables; see the individual table descriptions for more information.

For more information, see the diagram "Drive and Offset," above.

**HPF** [0...100]

The output of the waveshaper is processed through a simple highpass filter. This filter is primarily intended to prevent DC offsets in the waveshaped signal, which can cause unexpected clipping at the audio outputs, along with other strange results.

This parameter controls the cutoff of the filter. The default value of 5 is generally sufficient to block DC offsets. Higher values will make the sound increasingly thin, which may be useful for creative purposes.

**Makeup Gain** [-36dB...0dB...+36dB]

This provides additional gain to compensate for loss through the Waveshaper. For information on how to use this, see "Tip: Modulating Drive," below.

**Drive Parameter Details**

These items appear in the Parameter Details area when any of the parameters in the Waveshaper section other than **Offset** are selected. This includes **Table**, **Drive**, **Key Slope**, **Slope Shape**, **HPF**, and **Makeup Gain**.

**AMS** [List of AMS Sources]

This selects an AMS source to control the **Drive**. For a list of AMS sources, see "Alternate Modulation Source (AMS) List" on page 1091.

**Intensity** [-72dB...+72dB]

This controls the depth and direction of the **Drive** modulation.

**Tip: Modulating Drive**

Modulating **Drive** can be extremely useful for creating dynamic timbres. Depending on the selected table, this modulation will also often cause significant changes in overall level. You can compensate for this with a combination of **Makeup Gain** and **Output Level** modulation:

1. Set up an AMS source to modulate Drive.
2. Assign the same AMS source to modulate the main Output Level, inversely from Drive.

In other words, if you use a positive intensity for Drive AMS, use a negative intensity for Output Level AMS.

3. Adjust the Output Level AMS Intensity until the volume level stays sufficiently even.

The actual settings will vary depending on the input level and the selected table. Don't expect the **Output Level** intensity to be the same as that of **Drive**.

4. Increase the Waveshaper's Makeup Gain parameter to compensate for the reduction in volume.

**Offset Parameter Details**

These items appear in the Parameter Details area when the Waveshaper **Offset** parameter is selected.

**AMS** [List of AMS Sources]

This selects an AMS source to control the **Offset**. For a list of AMS sources, see "Alternate Modulation Source (AMS) List" on page 1091.

**Offset** can be modulated at note-on only. This works well with AMS sources such as Velocity and Exponential Velocity.

**Intensity** [-100...+100]

This controls the depth and direction of the AMS modulation for **Offset**.

## 5-4d: Keyboard Track

Each VPM Oscillator has its own keyboard tracking, which is dedicated to modulating the **Output Level** as you play up and down the keyboard.

KRONOS's keyboard tracking can be fairly complex, if desired. You can create different rates of change over up to four different parts of the keyboard.

### Tracking for timbre

Most acoustic instruments change in timbre as you play higher or lower pitches. At its most basic, keyboard tracking can compensate for these effects by adjusting the output level of an FM Modulator as you play higher and lower on the keyboard. With Modulators, raising the level will make the timbre brighter; reducing the level will make it darker.

### Tracking for aliasing

With FM, aliasing generally increases at higher frequencies (see "Aliasing" on page 341). Reducing Modulator levels at higher pitches is usually the most effective way to minimize aliasing.

### How it works: Keys and Ramps

The keyboard tracking works by creating four ramps, or slopes, between five keys on the keyboard. The bottom and top keys are fixed at the bottom and top of the MIDI range, respectively. You can set the other three keys—named **Low Break**, **Center**, and **High Break**—to be anywhere in between.

The four ramp values control the rate of change between each pair of keys. For instance, if the **Low-Center** Ramp is set to 0, the value will stay the same between the **Low Break** key and the **Center** key.

You can think of the resulting shape as being like two folding doors attached to a hinge in the center. At the **Center** key (the main hinge), the keyboard tracking has no effect. The two folding doors swing out from this center point to create changes in the higher and lower ranges of the keyboard.

### Key

#### Low Break [C-1...G9]

This sets the breakpoint note between the two lower ramps—the "hinge" of the lower door.

#### Center [C-1...G9]

This sets the center of the keyboard tracking—the main "hinge." At this key, the keyboard tracking has no effect on the volume, or on any AMS destinations.

#### High Break [C-1...G9]

This sets the breakpoint note between the two higher ramps—the "hinge" of the upper door.

### Entering notes from the keyboard

You can enter note numbers directly by playing them on the keyboard. To do so:

1. Select one of the Key parameters.
2. Hold down the ENTER key.
3. While holding ENTER, play a note on the keyboard.

### Ramp

Positive ramp values mean that the keyboard tracking output increases as you play farther from the **Center** key; negative ramp values mean that it decreases.

Because of this, the meanings of positive and negative ramp settings will change depending on whether the ramp is to the left or right of the **Center** key.

Also note that, as shown in the graphic "Amp Keyboard Tracking," below, negative slopes are more steep than positive slopes.

**Bottom-Low and Low-Center:** negative ramps make the keyboard tracking's output go down as you play lower on the keyboard, and positive ramps make the output go higher.

**Center-High and High-Top:** negative ramps make the keyboard tracking's output go down as you play *higher* on the keyboard, and positive ramps make the output go up.

#### Bottom-Low [-Inf, -99...+99, +Inf]

This sets the slope between the bottom of the MIDI note range and the **Low Break** key. For normal key track, use negative values.

#### Low-Center [-Inf, -99...+99, +Inf]

This sets the slope between the **Low Break** and **Center** keys. For normal key track, use negative values.

#### Center-High [-Inf, -99...+99, +Inf]

This sets the slope between the **Center** and **High Break** keys. For normal key track, use positive values.

#### High-Top [-Inf, -99...+99, +Inf]

This sets the slope between the **High Break** key and the top of the MIDI note range. For normal key track, use positive values.

Ramp	Change in level
-Inf	Silent in one half-step
-99	Silent in one whole-step
-95	Silent in one octave
-48	Silent in two octaves
-25	Silent in four octaves
00	no change
+25	x2 in four octaves
+50	x2 in two octaves
+99	x2 in one octave
+Inf	x2 in one half-step

### +Inf and -Inf ramps

**+Inf** and **-Inf** are special settings which create abrupt changes for split-like effects. When a ramp is set to **+Inf** or **-Inf**, the keyboard tracking will go to its extreme highest or lowest value over the span of a single key.

When a ramp is set to **+Inf**, the keyboard tracking will go to its highest value (double the programmed volume) over a single half-step.

Similarly, when a ramp is set to **-Inf**, the keyboard tracking will go to its lowest value (complete silence) over a single half-step.

Note: if you set the **Center-High** ramp to +Inf or -Inf, the **High-Top** parameter will be grayed out. Similarly, if you set the **Low-Center** ramp to +Inf or -Inf, the **Bottom-Low** ramp will be grayed out.

### Amp Keyboard Tracking

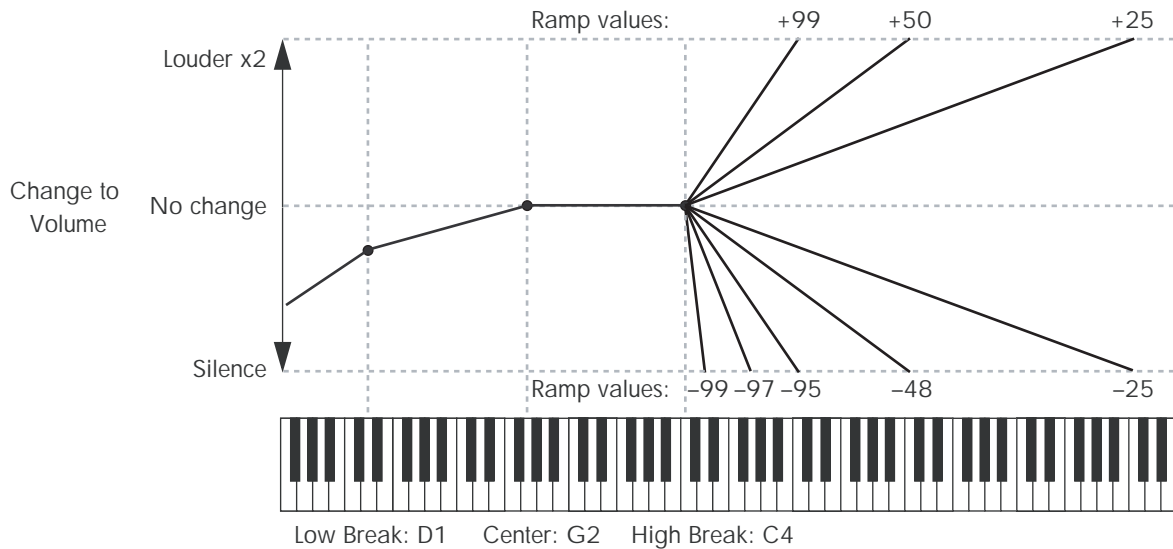

### Keyboard Track Parameter Details

The **Keyboard Track** graphic appears in the Parameter Details area when any of the Keyboard Track parameters are selected.

## 5-4e: Ring Modulator

Ring modulation adds new frequencies to the audio by multiplying one input, called the Carrier, by another, the Modulator.

In general, if the frequencies of the Carrier and Modulator are harmonically related, these new, added frequencies create brighter timbres. The brighter the inputs, the more new frequencies are created, and the greater the effect. Small amounts of detuning between the Carrier and Modulator produce more motion and richness in the output.

If the Carrier and Modulator frequencies are not related (by using lots of detune or frequency offset on one of them, for instance), the ring modulator creates dissonant, gong-like tones.

In the MOD-7, Input 1 always acts as the Modulator; it has a direct path into the ring modulator, which is not affected by the **Input Level** control. Depending on the selected VPM Oscillator **Mode**, the Carrier can be either the VPM Oscillator itself (after all applicable FM and waveshaping), or Input 2.

When **Mode** is set to **Waveshaper**, Input 2 is waveshaped before entering the ring modulator. There are many possibilities here, but two simple tables may be particularly useful: **Inverter1** creates a rectified signal, and **Integers** clips the signal to negative values only.

As with FM, ring modulation can produce aliasing—especially at higher frequencies.

For more information about using the ring modulator, including hands-on tutorials, see “Ring Modulation” on page 348.

### Crossfade

[Dry, 1:99...49:51, AM, 51:49...1:99, Wet]

This crossfades between the dry and ring-modulated signal. The center value, with equal amounts of wet and dry, produces AM (Amplitude Modulation). You can modulate this value in real-time, as described under “Crossfade Parameter Details,” below

### More details on ring modulation

In the most simple case, when both the Carrier and Modulator are sine waves, ring modulation produces two new frequencies. These new frequencies are called sidebands.

One is the “sum,” at the Carrier frequency *plus* the Modulator frequency. The other is the “difference,” at the Carrier frequency *minus* the Modulator frequency.

For instance, let’s say that Carrier is a 1,000Hz sine wave, and the Modulator is a 300Hz sine wave. The two sidebands would be at 1,300Hz (the sum) and 700Hz (the difference).

Notice that neither of these sidebands has a simple musical or harmonic relationship to the original tones. This is why the output can sound like a gong, with clangorous and dissonant overtones.

If the Modulator’s frequency is higher than that of the Carrier, the difference sideband is reflected around 0Hz, with a 180 degree phase shift. For instance, if the Carrier is at 100Hz and the Modulator is at 400Hz, the difference sideband would be 300Hz, 180 degrees out of phase.

The effect becomes much more complex when using inputs other than pure sine waves, since separate sum and difference tones are created for each component frequency in each input.

For instance, let's say that the Carrier now has two sine waves, at 1000Hz and 2000Hz respectively, and that the Modulator also has two sine waves, at 300Hz and 600Hz. The output of the ring modulator would then include eight different sidebands:

- 1,300Hz (1,000Hz+300Hz)
- 1,600Hz (1,000Hz+600Hz)
- 700Hz (1,000Hz-300Hz)
- 400Hz (1,000Hz-600Hz)
- 2,300Hz (2,000Hz+300Hz)
- 2,600Hz (2,000Hz+600Hz)
- 1700Hz (2,000Hz-300Hz)
- 1400Hz (2,000Hz-600Hz)

If both inputs contain three frequencies each, the number of sidebands grows to 18; if they contain four frequencies each, it grows to 32; with five each, the sidebands grow to 50. So, the effect can become very complicated, very fast!

(If the Carrier and Modulator are harmonically related, the frequencies of some of the sidebands may be the same, resulting in a somewhat simpler tone.)

If one or more sum frequencies are higher than 24kHz (half of the sample rate), this will cause aliasing. Aliasing adds its own sidebands, which may or may not enhance the effect of the ring modulator. If you want to minimize aliasing, avoid using bright tones for both the Carrier and Modulator simultaneously. If one of the sounds is very bright, consider using a dark, lowpassed sound for the other.

**Crossfade Parameter Details**

These items appear in the Parameter Details area when the Ring Modulator **Crossfade** parameter is selected.

**AMS** [List of AMS Sources]

This selects an AMS source to control the **Crossfade**. For a list of AMS sources, see "Alternate Modulation Source (AMS) List" on page 1091.

**Intensity** [-100...+100]

This controls the depth and direction of the AMS modulation for **Crossfade**.

**5-4f: Output**

**On** [Checkbox]

This mutes and un-mutes the entire VPM Oscillator, for quick comparisons during editing. This parameter is also shown in the Parameter Details on the Patch Panel.

Note that the Oscillator will still use processing power unless the **Mode** is set to **Off**.

**Output Level** [0...100]

This sets the basic output level of the VPM Oscillator. It is also shown in the Parameter Details on the Patch Panel.

If the Oscillator is an FM Modulator, the output level affects the brightness of its associated Carrier(s). If the Oscillator is an FM Carrier, the output level affects volume.

**EG Select** [None, EG1...EG9, Amp EG]

This selects any of the 10 EGs to control the Oscillator's output level. By default, EGs 1-6 are assigned to VPM Oscillators 1-6, EG7 is assigned to the PCM Oscillator, and EG8 is assigned to Filter A **Cutoff**.

**None** is the same as if the EG was always at its maximum level.

**Velocity Sens** [-100...+100]

This controls the degree to which output level responds to velocity. Negative settings are useful for creating velocity crossfades between two sets of VPM Oscillators.

**Output Level Parameter Details**

These items appear in the Parameter Details area when any of the parameters in the Output section are selected. This includes **On**, **Output Level**, **EG Select**, and **Velocity Sens**.

**AMS Mode** [Add, Multiply]

To calculate the VPM Oscillator's output volume, the main **Level** parameter, **Velocity Sens**, **Key Tracking**, and the selected **EG** are always multiplied together. If the value of any of these is at 0, none of the others has any effect. For instance, if the selected **EG** falls to 0, **Key Tracking** can't bring the level back up again.

The **AMS Mode** parameter determines how AMS modulation (including Int Mod) interacts with these other modulators.

**Add:** AMS is added in after **Level**, **Velocity Sens**, **Key Tracking**, and the **EG** are multiplied together. This means that even if one of the main values is at 0, AMS can still bring up the volume to its maximum.

You can also think of this as having parallel modulation paths: **EG**, **Key Track**, and **Velocity Sensitivity** on one side, and **AMS** on the other.

Expressed mathematically, this is:  
 $Volume = (Level * EG * Key Track * Vel Sens) + AMS$ .

**Multiply:** This is the default, and is similar to the way that most other KRONOS Amp modulation works. **AMS** is multiplied along with all of the other modulators.

Expressed mathematically, this is:  
 $Volume = Level * EG * Key Track * Vel Sens * (1 + AMS)$ .

**AMS** [List of AMS Sources]

This selects the main modulation source for controlling the **Output Level**. For a list of AMS sources, see "Alternate Modulation Source (AMS) List" on page 1091.

**Intensity** [-100...+100]

This controls the depth and direction of the **Output Level** modulation.

**AMS Int. Mod** [List of AMS Sources]

You can modulate the **AMS Intensity** from another **AMS** source. This selects that source.

**Intensity** [-100...+100]

This controls the depth and direction of the Intensity Mod AMS. The result is summed with the main AMS 1 Intensity to produce the final **Output Level** modulation amount.

---

**5–4g: Parameter Details**

The Parameter Details area shows information for the selected item, including explanatory graphics and AMS modulation routings.

- The Mode graphic appears when any of the parameters in the Main section are selected.
- Pitch Modulation appears when **Ratio**, (Ratio) **Fine**, **Freq Offset**, (Freq Offset) **Fine**, **Initial Phase**, or **Phase Sync** are selected.
- Feedback Modulation appears when **Feedback** is selected.
- Drive Modulation appears when any of the parameters in the Waveshaper section other than **Offset** are selected. This includes **Table**, **Drive**, **Key Slope**, **Slope Shape**, **HPF**, and **Makeup Gain**.
- Offset Modulation appears when the Waveshaper **Offset** parameter is selected.

- The Keyboard Track graphic appears when any of the parameters in the Keyboard Track section are selected.
- Crossfade Modulation appears when (Ring Mod) **Crossfade** is selected.
- Output Level Modulation appears when any of the parameters in the Output section are selected.

---

▼ **5–4: Page Menu Commands**

The number before each command shows its ENTER + number-key shortcut. For more information on these shortcuts, see “ENTER + 0-9: shortcuts for menu commands” on page 147.

- 0: **Write Program**. For more information, see “Write Program” on page 147.
- 1: **Exclusive Solo**. For more information, see “Exclusive Solo” on page 147.
- 2: **Copy VPM Oscillator**. For more information, see “Copy VPM Oscillator” on page 386.
- 3: **Swap VPM Oscillators**. For more information, see “Swap VPM Oscillators” on page 386.

---

**5–5: VPM Oscillator 2**

---

**5–6: VPM Oscillator 3**

---

**5–7: VPM Oscillator 4**

---

**5–8: VPM Oscillator 5**

---

**5–9: VPM Oscillator 6**

VPM Oscillators 2 through 6 are identical to VPM Oscillator 1. For detailed parameter explanations, please see “5–4: VPM Osc1” on page 365.



## Program P6: Filter

---

### 6-1: Filter Basic

---

#### Overview

The MOD-7 includes dual multimode resonant filters, including Korg's Multifilter. These filters are almost identical to those of the AL-1, except for the following:

- There is no **Trim** parameter. (This was unnecessary even in the AL-1, since the filter will not clip internally.) Output volume is still available and modulatable.
- The patch panel allows individual access to Filters A and B, and so the **Routing** parameter provides only **Parallel** and **4-Pole** modes. You can create serial routing using the patch panel, if desired.
- Similarly, since Filters A and B have independent outputs which can be routed separately to the main mixer, there are no filter-specific Pan or Pan AMS

controls. The main mixer supports modulatable Pan for all 6 inputs.

For detailed descriptions of the filter parameters, see "5-1: Filter Basic" on page 196.

For information about using the filters in the MOD-7, including hands-on tutorials, see "Filtered VPM" on page 344.

---

#### Filters and the Analog parameter

When the Oscillator Main page **Analog** parameter is greater than 0, Filters A and B each get a different random detune value (including when **Link** is set to On).

If you want the two filters to be perfectly in tune, turn **Analog** to 0.

---

### 6-2: Multi Filter

The Multi Filter is identical to that of the AL-1. For detailed information, see "5-2: Multi Filter" on page 199.

---

### 6-3: Filter Modulation

The Filter Modulation page is almost identical to that of the AL-1. For detailed information, see "5-3: Filter Modulation" on page 200.

There is one exception: in the Filter A and B **EG Select** parameters, you can select any of the MOD-7 envelopes: EG1...EG9, plus the Amp EG.

---

### 6-4: Filter LFO Mod

The Filter LFO Mod page is identical to that of the AL-1. For detailed information, see "5-4: Filter LFO Mod" on page 203.

# Program P7: Amp

## 7-1: Mixers 1-3

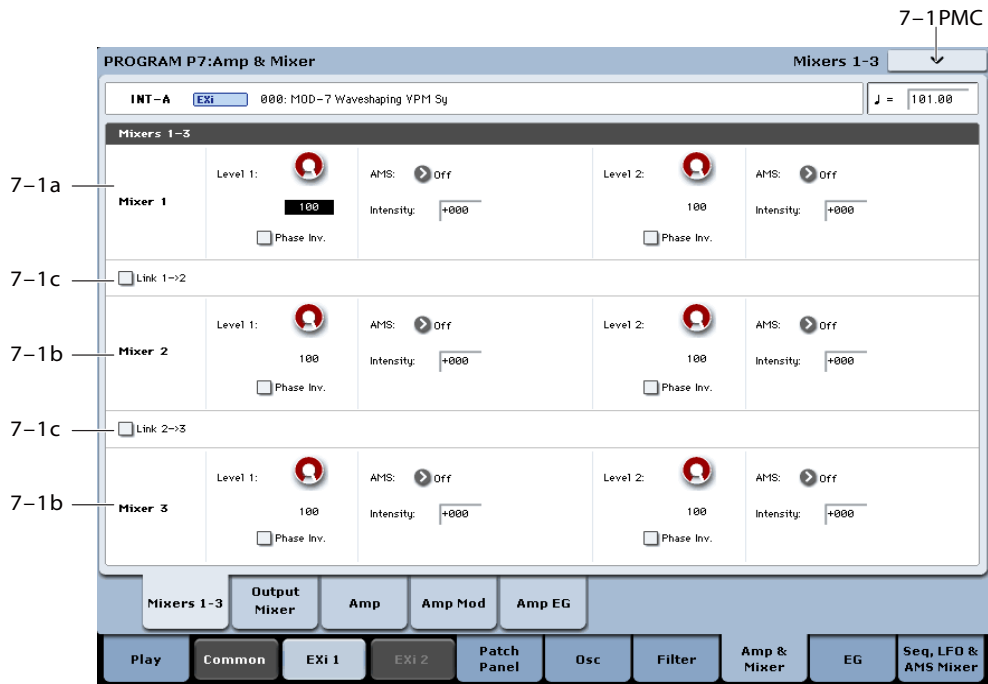

### Overview

These are the three 2-in, 1-out mixers on the Patch Panel. They can be used for mixing signals together, or for additional control of volume and phase. All input levels can be modulated via AMS.

#### Tip: using a VPM Oscillator as a mixer

The three mixers should be sufficient for almost all purposes. In a pinch, however, you can also create a mixer out of an unused VPM Oscillator. To do so, set the Mode to Waveshaper, and set the Table to Linear. Note that this has a much higher CPU cost than a normal mixer.

#### Tip: creating splits between elements

You can easily create a keyboard or velocity split between two different sounds within a single MOD-7 patch. To do so:

1. Create the two elements of the patch.  
For instance, three VPM oscillators creating a bell timbre, and three others creating a pad.
2. Route the two elements to two inputs of any mixer.  
You can use one of Mixers 1-3, or the main mixer.
3. On the mixer, set input 1's level to 100, and input 2's level to 0.
4. Set an AMS Mixer to Gate.
5. In the AMS Mixer, set the Source to Note Number to create a keyboard split, or to Velocity or Exp Velocity to create a velocity split.
6. Set both the Below and At & Above outputs to fixed values; 00 for below, 99 for above.

7. The Threshold controls the split point; set it as desired.

When the Source is set to Note Number, a Threshold of 00 is middle C.

8. Assign the output of the AMS Mixer to modulate the two mixer inputs from step (1).
9. Set the AMS Intensity to -100 for input 1, and +100 for input 2.

Now, if the input is below the Threshold, input 1 will be heard; if the input is above the Threshold, input 2 will be heard.

### 7-1a: Mixer 1

#### Input 1

**Level** [0...100]

This controls the volume level for input 1.

**Phase Invert** [Off, On]

This inverts the phase of input 1.

**AMS** [List of AMS Sources]

This selects the main modulation source for controlling the Level. For a list of AMS sources, see "Alternate Modulation Source (AMS) List" on page 1091.

**Intensity** [-100...+100]

This controls the depth and direction of the Level modulation.

**Input 2**

The controls for Input 2 are the same as those for “Input 1,” above.

**7-1b: Mixers 2 and 3**

The controls for Mixers 2 and 3 are the same as those for “7-1a: Mixer 1,” above.

**7-1c: Link buttons**

The Link buttons let you combine two or three of the mixers together, cascading the output of one into the next.

To create a 4-in, 1-out mixer, use either of the Link buttons. To create a 6-in, 1-out mixer, use both of them.

Internally, Mixers 2 and 3 have a third input dedicated to the Link function. This input is unity gain only, without a volume control.

**Link 1->2**

[Off, On]

This merges the output of Mixer 1 into the output of Mixer 2.

**Link 2->3**

[Off, On]

This merges the output of Mixer 2 into the output of Mixer 3.

**▼ 7-1: Page Menu Commands**

The number before each command shows its ENTER + number-key shortcut. For more information on these shortcuts, see “ENTER + 0-9: shortcuts for menu commands” on page 147.

- **0: Write Program.** For more information, see “Write Program” on page 147.
- **1: Exclusive Solo.** For more information, see “Exclusive Solo” on page 147.

**7-2: Main Mixer**

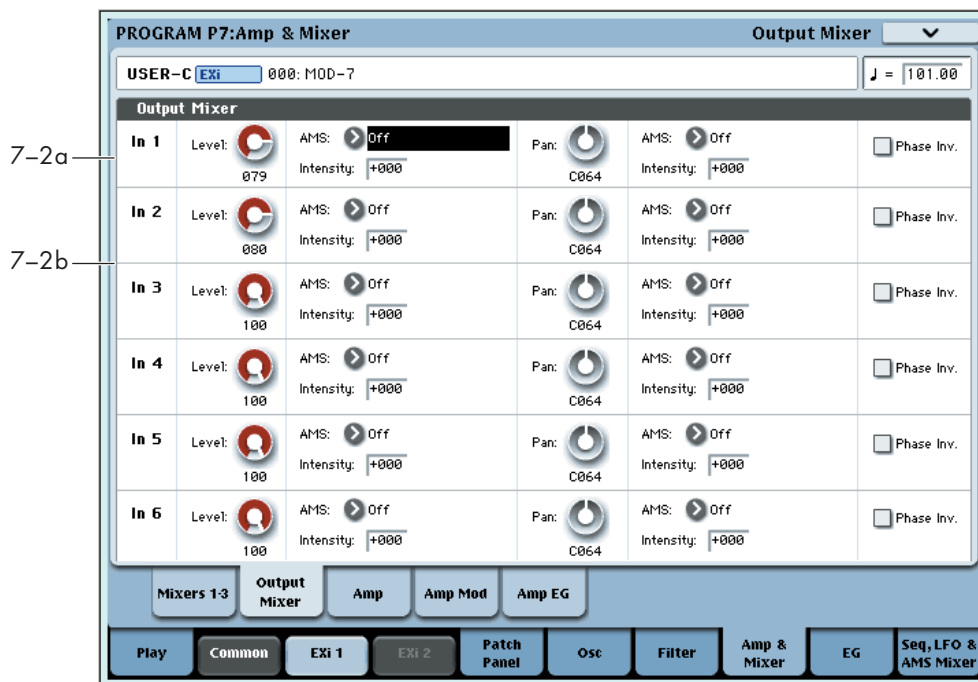

The Main Mixer is a 6-in, stereo-out mixer, which takes signals from the Patch Panel and routes them to the Amp section.

**Important:** In order to hear the output of any block on the Patch Panel, including the VPM Oscillators, the PCM Oscillator, the Noise Generator, the Audio Input, and the Filters, the signal must eventually be patched into the Main Mixer.

In the Main Mixer, you can:

- Control the volume level, pan, and phase for each of the six inputs
- Modulate volume levels and pan via AMS.

**7-2a: Input 1**

**Level**

[0...100]

This controls the volume level for Input 1.

**AMS**

[List of AMS Sources]

This selects an AMS source to control the **Level**. For a list of AMS sources, see “Alternate Modulation Source (AMS) List” on page 1091.

**Intensity**

[-100...+100]

This controls the depth and direction of the **Level** AMS modulation.

**Pan** [L000...C064...R127]

This controls the input's stereo pan. A setting of L000 places the sound at the far left, C064 in the center, and R127 to the far right.

**AMS** [List of AMS Sources]

This selects an AMS source to modulate Pan. For a list of AMS sources, see "Alternate Modulation Source (AMS) List" on page 1091.

**Intensity** [-127...+127]

This controls the depth and direction of the AMS modulation for Pan.

For example, if Pan is set to C064 and AMS is set to Note Number, **positive (+)** intensities will cause the sound to move toward the right as you play higher than C4, and toward the left as you play lower than C4.

**Negative (-)** intensities will have the opposite effect.

**Phase Invert** [Off, On]

This inverts the phase of Input 1.

**Tip: Creating random panning**

Mixer inputs have no random pan setting per se. However, you can create this effect easily using AMS. To do so:

1. Set the input's Pan to C064.

2. Set the Pan AMS Intensity to +64.

3. Assign an unused LFO to Pan AMS.

Next, make the following settings in the LFO:

4. Enable the Key Sync check-box.

5. Set the Waveform to Random 1.

6. Enable the Stop check-box.

**Stop** makes the LFO generate a single value at note-on, and then hold that value. Now, the input will have a different random pan position each time you play a note.

---

## 7-2b: Inputs 2...6

The controls for Inputs 2 through 6 are the same as those for Input 1, above.

---

## ▼ 7-2: Page Menu Commands

The number before each command shows its ENTER + number-key shortcut. For more information on these shortcuts, see "ENTER + 0-9: shortcuts for menu commands" on page 147.

- 0: **Write Program**. For more information, see "Write Program" on page 147.
- 1: **Exclusive Solo**. For more information, see "Exclusive Solo" on page 147.

---

## 7-3: Amp

The Amp page is identical to that of the STR-1. For detailed information, see "6-1: Amp" on page 283.

---

## 7-4: Amp Modulation

The Amp Modulation page is identical to that of the STR-1. For detailed information, see "6-2: Amp Modulation" on page 284.

---

## 7-5: Amp EG AMSource

The Amp EG interacts with the Amp and Amp Modulation settings to control the overall volume of the MOD-7. This EG always affects that overall volume, but it can also be used as an EG and AMS source elsewhere in the MOD-7.

The Amp EG is almost identical to EGs 1-9, with the following exceptions:

- Levels can only be positive.
- The Amp EG cannot be reset after it has entered its release phase.

For more information, please see "8-1: EG 1" on page 380.

## Program P8: EG 1–9

The MOD-7 has nine assignable EGs, in addition to the Amp EG. Each of these can be used as an AMS modulation source to control a wide variety of parameters.

By default, EGs 1–6 are assigned to Output Level on VPM Oscillator 1–6, EG 7 is assigned to Output Level on the PCM Oscillator, and EG 8 is assigned to Filter A Cutoff.

These EGs are similar to those of the AL-1, but with slightly simplified AMS modulation, **Sustain Level** modulation, and a new parameter: **Trigger at Note-On**.

### 8–1: EG 1 AMSource

The EGs, or Envelope Generators, let you create complex, time-varying changes to AMS-modulatable parameters. The controls on this page specify the shape of the EG. Among other things, you can:

- Create the basic EG shape by setting the levels and times of each segment.
- Control the curvature of each EG segment, for subtle control over the sound of the EG.
- Set up complex modulation of EG levels and times.
- Set up an AMS source, such as an LFO, to restart the EG.

One thing that you can't do on this page is to control how much effect the EG has on the parameters it modulates. To do that, you'll need to adjust the AMS intensities on the pages for the individual parameters.

#### 8–1a: EG Reset

##### AMS [List of AMS Sources]

This selects an AMS source to reset the EG to the start point. For instance, you can use a tempo-synced LFO to trigger the EG in a repeating rhythm.

For a list of AMS sources, see "Alternate Modulation Source (AMS) List" on page 1091.

##### Threshold [–99...+99]

This sets the AMS level which will trigger the EG reset. Among other things, you can use this to adjust the exact point in an LFO's phase at which the EG will be reset, effectively controlling its "groove" against other rhythmic effects.

When the threshold is **positive**, the EG triggers when passing through the threshold moving upwards. When the threshold is **negative**, the EG triggers when passing through the threshold moving downwards.

**Note:** with some LFO shapes, and with faster LFO speeds, the LFO may not always reach the extreme values of +99 or -99. In this case, setting the **Threshold** to these values may cause inconsistent behavior, or may mean that the EG doesn't reset at all. If this happens, reduce the **Threshold** until the EG triggers consistently.

##### Trigger at Note-On [Check-box]

**On** means that the EG will start automatically at note-on. This is the default.

**Off** means that the EG will only start when triggered via the selected AMS source. This is useful for delayed EGs, or triggered effects such as those described below.

**Note:** even when this is set to **Off**, if the selected AMS trigger source is above the threshold at note-on, then the EG will trigger instantly.

##### Tip: Multiple Rhythmic Envelopes via the Step Sequencer

1. Set up several EGs with **Trigger at Note-On** set to **Off**, and the trigger AMS source set to the per-voice Step Sequencer.
2. Set each EG to use a different threshold value, so that the first to trigger has a low threshold, the next to trigger has a slightly higher threshold, and so on.

You can then use the Step Sequencer to trigger each EG at a specified time, synced to tempo. For complex rhythmic variations, you can then loop the Step Sequencer, modulate its start point, and reset the Step Sequencer from another AMS source.

##### Tip: Multiple Rhythmic Envelopes via LFOs

1. Set up several EGs with **Trigger at Note-On** set to **Off**, and the trigger AMS source set to one or more LFOs.
  2. Set the LFO(s) to sync to tempo, with a large note value (such as a whole note).
- By using a couple of LFOs at different frequencies, you can set up complex, essentially non-repeating patterns.
3. Set the LFO waveform(s) to **Triangle**.
  4. Using the same trick as above, set the EG's thresholds to different levels.

You could also use this method with non-tempo-synced LFOs and slow EGs, to create gentle, evolving sounds.

## 8–1b: Envelope

EG

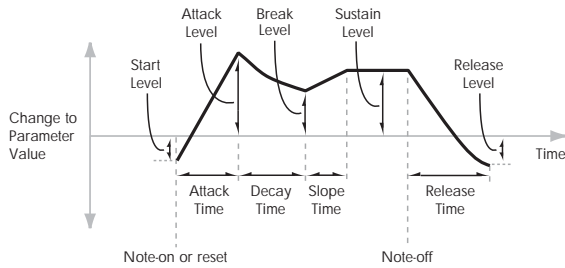

Envelopes create a modulation signal by moving from one level to another over a specified time, and then moving to another level over another period of time, and so on.

The parameters below let you set five levels, the amount of time it takes to go from each of the levels to the next, and the shape (from linear to curved) of each transition.

### Level

Each of the five levels can be either positive or negative.

**Positive** levels will make the cutoff frequency (or other AMS destination) go up from its programmed value; **negative** levels will make it go down.

**Start** [-99...+99]

This sets the initial EG level, at note-on.

**Attack** [-99...+99]

This sets the level at the end of the Attack time.

**Break** [-99...+99]

Break, short for Break Point, sets the level at the end of the Decay time.

**Sustain** [-99...+99]

This sets the level at the end of the Slope time. Once it reaches the Sustain level, the EG will stay there until note-off, unless it is reset via AMS.

**Release** [-99...+99]

This sets the level at the end of the Release time.

### Time

Higher values mean longer times, as shown below:

EG Value	Actual Time
00	0.667 ms
10	10 ms
20	44 ms
30	104 ms
40	224 ms
50	464 ms
60	944 ms
70	1.8 seconds
80	3.8 seconds

EG Value	Actual Time
90	10.9 seconds
99	87.3 seconds

**Attack** [00...99]

This sets how long the EG takes to move from the Start level to the Attack level.

The minimum attack time is 2/3 of a millisecond—as fast as the most punchy of classic analog synths.

For the fastest possible attack time, you can set the Start level to +99; in this case, the EG will start instantaneously at its maximum value.

**Decay** [00...99]

This sets the time it takes to move from the Attack level to the Break level.

**Slope** [00...99]

This sets how long the EG takes to move from the Break level to the Sustain level. Once it reaches the Sustain level, the EG will stay there until note-off (unless it is reset via AMS).

**Release** [00...99]

This sets how long it takes the EG to move from the Sustain level to the Release level.

### Curve

For the sake of simplicity, most of the diagrams in this manual show envelopes as being made out of straight lines. In actuality, though, envelopes are more likely to be made out of curves.

In other words, each segment's level will change quickly at first, and then slow down as it approaches the next point. This tends to sound better than straight, linear segments.

Classic analog synth envelopes made these curved shapes naturally. The KRONOS goes a step further than vintage synths, however, and lets you control the amount of curvature separately for each of the four envelope segments.

When you change the curvature, the EG times remain the same. However, greater curvature will tend to *sound* faster, because the value changes more quickly at the beginning.

### Different curve settings for up and down

You may find that different amounts of curvature are suitable for segments which go up and segments which go down.

For instance, a curve of 3 is a good default setting for upward segments, such as Attack. On the other hand, a curve of 6 or more is good for downward segments, such as Decay and Release.

EG Curve

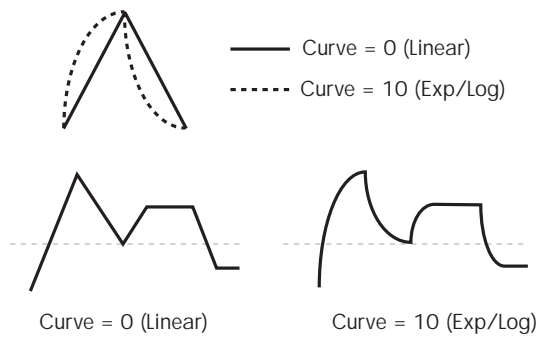

**Attack** [0 (Linear), 1...9, 10 (Exp/Log)]

This sets the curvature of the Attack segment - the transition from the Start level to the Attack level.

**Decay** [0 (Linear), 1...9, 10 (Exp/Log)]

This sets the curvature of the Decay segment - the transition from the Attack level to the Break level.

**Slope** [0 (Linear), 1...9, 10 (Exp/Log)]

This sets the curvature of the Slope segment - the transition from the Break level to the Sustain level.

**Release** [0 (Linear), 1...9, 10 (Exp/Log)]

This sets the curvature of the Release segment - the transition from the Sustain level to the Release level.

**8-1c: Level Modulation**

These settings let you use an AMS source to control the Level parameters of the EG. The Start, Attack, Break, and Sustain levels share a single AMS source, but each has its own modulation intensity.

By using different settings for each of the four levels, you can cause both subtle and dramatic changes to the EG shape, as shown below.

EG Level Modulation

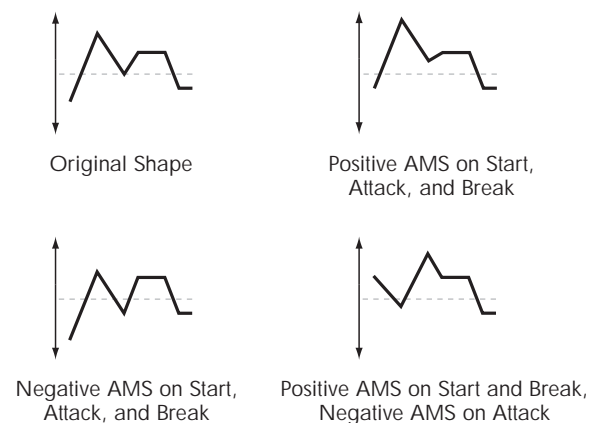

**Once an EG segment begins, it can't be modulated**

Once the EG has started a segment between two points, that segment can no longer be modulated. This includes both the time of the segment, and the level reached at the end of the segment.

For instance, if the EG is in the middle of the Decay time, you can no longer modulate either the Decay time or the Break level.

As another example, let's say that you've assigned the Common LFO to modulate Break Level. The LFO may be moving all the time, but the Break Level is only affected by the LFO's value at the instant that the Decay segment starts. After that, the level is fixed.

Finally, this also means that modulating the Start level, Attack level, or Attack time will not affect notes that are already sounding, unless the EG is then reset via AMS.

**AMS** [List of AMS Sources]

This selects an AMS source to control the EG's Level parameters.

For a list of AMS sources, see "Alternate Modulation Source (AMS) List" on page 1091.

**Start** [-99...+99]

This controls the depth and direction of the AMS modulation for the Start level.

For example, if you set the AMS source to Velocity and set Start to +99, the Start level will increase as you play harder. If you instead set Start to -99, the Start level will decrease as you play harder.

**Attack** [-99...+99]

This controls the depth and direction of the AMS modulation for the Attack level.

**Break** [-99...+99]

This controls the depth and direction of the AMS modulation for the Break level.

**Sustain** [-99...+99]

This controls the depth and direction of the AMS modulation for the Sustain level.

**8-1d: Time Modulation**

These settings let you use an AMS source to control the Time parameters of the EG. The Attack, Decay, Slope, and Release times share a single AMS source, but each has its own modulation intensity.

EG Time Modulation

AMS=Velocity, Intensity = a positive (+) value

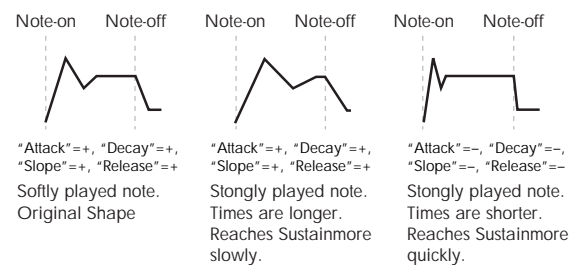

**AMS** [List of AMS Sources]

Selects the AMS source to control the EG's Time parameters. Velocity and Keyboard Track can both be useful here, for instance.

For a list of AMS sources, see "Alternate Modulation Source (AMS) List" on page 1091.



**Attack** [-99...+99]

This controls the depth and direction of the AMS modulation for the Attack time.

When the AMS source is at its maximum value—for instance, when Velocity is at 128—a setting of +8 will make the segment time almost twice as long, and a setting of -8 will cut the segment time almost in half.

For example, if you set the AMS source to Velocity and set Attack to +99, the Attack time will get much longer at higher velocities. If you instead set Attack to -99, the Attack time will get much shorter at higher velocities.

**Decay** [-99...+99]

This controls the depth and direction of the AMS modulation for the Decay time.

**Slope** [-99...+99]

This controls the depth and direction of the AMS modulation for the Slope time.

**Release** [-99...+99]

This controls the depth and direction of the AMS modulation for the Release time.

---

▼ **8–1: Page Menu Commands**

The number before each command shows its ENTER + number-key shortcut. For more information on these shortcuts, see “ENTER + 0-9: shortcuts for menu commands” on page 147.

- 0: **Write Program**. For more information, see “Write Program” on page 147.
- 1: **Exclusive Solo**. For more information, see “Exclusive Solo” on page 147.
- 2: **Copy Envelope**. For more information, see “Copy Envelope” on page 224.
- 3: **Swap Envelope**. For more information, see “Swap Envelope” on page 224.

---

**8–2: EG 2** AMSource

---

**8–3: EG 3** AMSource

---

**8–4: EG 4** AMSource

---

**8–5: EG 5** AMSource

---

**8–6: EG 6** AMSource

---

**8–7: EG 7** AMSource

---

**8–8: EG 8** AMSource

---

**8–9: EG 9** AMSource

The MOD-7’s EGs 2 through 9 are identical to EG1. For detailed explanations, please see “8–1: EG 1” on page 380.

## Program P9: Step Sequencer, LFO 1-4, and AMS Mixers

The MOD-7 has one per-voice Step Sequencer and four assignable LFOs, in addition to the EXi Program's Common LFO and Common Step Sequencer. Each of these can be used as an AMS modulation source to control a wide variety of parameters.

There are also eight AMS Mixers: four full-functioned, and another four which support only the **A+B** and **Amt AxB Mixer Types**.

---

### 9-1: Step Sequencer AMSource

The MOD-7's Step Sequencer identical to that of the AL-1. For detailed explanations, please see "8-1: Step Sequencer," on page 215.

---

### 9-2: LFO 1 AMSource

---

### 9-3: LFO 2 AMSource

---

### 9-4: LFO 3 AMSource

---

### 9-5: LFO 4 AMSource

The MOD-7's LFOs 1, 2, 3, and 4 are identical to those of the AL-1. For detailed explanations, please see "8-2: LFO 1," on page 217.

---

### 9-6: AMS Mixers 1-2 AMSource

---

### 9-7: AMS Mixers 3-4 AMSource

The MOD-7's AMS Mixers 1 through 4 are identical to those of the AL-1. For detailed explanations, please see "9-1: AMS Mixer," on page 221.

---

### 9-8: AMS Mixers 5-6 AMSource

---

### 9-9: AMS Mixers 7-8 AMSource

The MOD-7's AMS Mixers five through 8 are similar to those of the AL-1, but support only the **A+B** and **Amt AxB Mixer Types**. For detailed explanations, please see "9-1: AMS Mixer," on page 221.

## MOD-7: Tone Adjust

MOD-7 Tone Adjust Default Settings

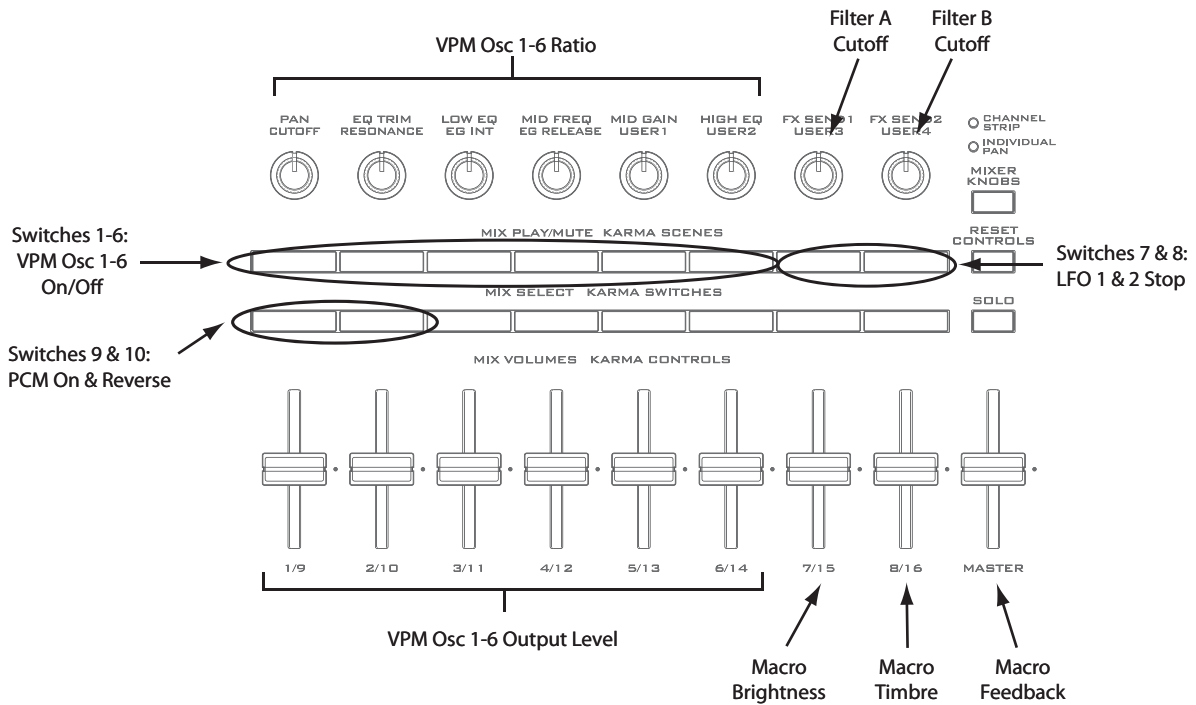

Tone Adjust provides an elegant physical interface to the MOD-7's parameters. Most of the factory sounds use the default layout, as shown above. You can also customize the layout for individual sounds, if desired. For more information about Tone Adjust, please see "0-9f: Tone Adjust," on page 30.

### Common Tone Adjust parameters

Except as noted below, the Common Tone Adjust parameters behave as described under "Common Tone Adjust Parameters," on page 32.

**Filter/Amp EG Attack Time.**  
(-99...+99, CC#73)

This scales the attack time of EG8 and the Amp EG. It interacts with CC# 73.

**Filter/Amp EG Decay Time.**  
(-99...+99, CC#75)

This scales the decay time of EG8 and the Amp EG. It interacts with CC# 75.

**Filter/Amp EG Sustain Level.**  
(-99...+99, CC#70)

This scales the sustain levels of EG8 and the Amp EG. It interacts with CC# 70.

**Filter/Amp EG Release Time.**  
(-99...+99, CC#72)

This scales the release time of EG8 and the Amp EG. It interacts with CC# 72.

**Filter EG Attack Time, Decay Time, Sustain Level, and Release Time** apply to EG8.

**Pitch EG Attack Time, Decay Time, Sustain Level, and Release Time** are not supported by the MOD-7.

### MOD-7 Tone Adjust parameters

In addition to the Common Tone Adjust parameters listed above, the MOD-7 adds a number of its own parameters.

Note that these additional parameters are separate for each EX<sub>i</sub>, as opposed to being shared by both EX<sub>i</sub> in the Program.

All of the additional parameters are listed below. Tone Adjust parameters may affect the internal parameters in one of two ways: they may be **Relative**, in which case they scale the existing parameter value, or **Absolute**, in which case they over-write the existing value. Unless otherwise noted, all of the MOD-7 parameters are **Absolute**.

The full name of the currently selected parameter is shown in the status line at the top of the Control Surface page, as well as in the popup menu. Some parameters with longer names may show an abbreviation for the slider, knob, and switch labels.

#### Macro Parameters

Brightness  
Brightness Vel Sens  
Timbre  
Feedback  
Detune

#### Noise

Saturation  
Filter Freq

### PCM Oscillator

On/off  
MS Select  
MS Bank  
MS Min  
MS Max  
Start Offset  
Reverse  
Transpose  
Tune

### VPM Oscillators 1...6

On/off  
Mode  
Feedback  
Ratio  
Table

Drive  
Output Level

### Filters A and B

Type  
Cutoff  
Resonance  
EG Int  
LFO Int

### LFOs

In addition to supporting the standard Tone Adjust LFO parameters, the MOD-7 adds the following separate controls:

- LFO 1 through 4 Waveform
- LFO 3 and 4 Speed

### Step Sequencer

Attack Smoothing  
Decay Smoothing

---

## MOD-7: Page Menu Commands

---

### Copy VPM Oscillator

This command copies all the parameters of one VPM Oscillator to another VPM Oscillator. A dialog box allows you to select the source and destination Oscillators, within the current Program.

---

### Swap VPM Oscillators

This command swaps all of the parameters between two VPM Oscillators, like copying each to the other in a single step. Note that it does not automatically copy any Patch Panel connections; you'll need to do that manually, if necessary.

For instance, let's say that you've created a custom algorithm bit by bit, and you end up with two chains of Modulators and Carriers:

VPM Osc 1->VPM Osc 2->VPM Osc 6

VPM Osc 4->VPM Osc 5->VPM Osc 3

To make the algorithm easier to understand, you might want to do the following:

1. Use the Swap VPM Oscillator command to swap the parameters of VPM Osc 3 and VPM Osc 6.
2. Manually correct the Patch Panel connections to VPM Osc 3 and 6, as necessary.

# EXi: SGX-1 Premium Piano

## SGX-1 Overview

The SGX-1 Premium Piano EXi is designed to provide an optimal acoustic piano experience, combining world-class sounds, subtle performance nuances, and a dedicated, easy-to-use interface. Features include:

- Virtual Memory Technology (VMT), for access to gigabytes of sample data
- Full chromatic sampling, with every note sampled in stereo at up to 8 velocity levels, for natural and smooth response
- True damper resonance, also chromatically sampled, with multiple velocity layers
- No loops: sounds decay naturally
- High polyphony—up to 100 dual-stereo voices, the equivalent of 400 mono voices
- Realistic performance nuances, including mechanical noise controlled by release velocity, damper pedal noise controlled by pedal velocity, and note release

---

## Unsupported EXi Common parameters

The SGX-1 supports most of the EXi Common parameters, except for the voice allocation options detailed below:

- **Poly Legato**
- **Mono Mode** (Normal or Use Legato Offset)
- **Unison**, including **Number of Voices**, **Detune**, and **Thickness**

## EXi Program P0: Play

### 0-1: Main



This is the main page of Program mode. For a full description of this page and all of its functions, please see “EXi Program P0: Play” on page 165. This section describes only the overview display, which differs for each individual EXi.

#### 0-1b: Overview and Page Jump

This part of the page shows an overview of the most important settings for the Program’s two EXi instruments. The specific parameters will vary, depending on which EXi are being used. The parameters for the SGX-1 are described below.

The graphics give you a quick way to check all of these settings at a glance. They also let you jump instantly to any of the displayed parameters. Just touch one of the graphics, and you’ll jump to the page containing its parameters.

*Tip:* Pressing EXIT several times will always bring you back to this page.

#### Piano Type

This shows the selected Piano Type, which controls the basic sound of the SGX-1. Touch this area to jump to the SGX-1’s Main page. For more information, see “Program P4: Main” on page 390.

#### Components and levels

This section shows the status and volume levels of the Damper Resonance, Damper Noise, Mechanical Noise, and Note Release components. If a component is turned off, it’s shown in gray. Touch this area to jump to the SGX-1’s Main page.

#### Piano graphic

This shows the lid position setting. Touch the graphic to jump to the SGX-1’s Main page.

#### Common Key Zone

This shows the key zones for EXi1 and EXi2, as set on the Common section’s Program Basic page, in relation to the entire MIDI note range. The range of the 61-, 73-, or 88-note keyboard is also shown, as appropriate.

Press this area to jump to the Program Basic page.

#### Common

The graphics along the right side of the screen show the most important Common parameters, which are shared by both EXi in the Program. This section will always show the same parameters, regardless of which EXi are being used.

#### Common Voice Assign Mode

This shows the voice assign mode of the Program—either POLY or MONO.

Press this area to jump to the Program Basic page.

#### Common Step Sequencer

This shows a graphic overview of the Common Step Sequencer.

Press this area to jump to the Common Step Sequencer page.

#### Common LFO Graphic

This shows the waveform of the Common LFO.

Press this area to jump to the Common LFO page.

**3 Band EQ Graphic**

This shows the mid-sweepable 3-band EQ.

Press this area to jump to the EQ page.

**IFX, MFX/TFX**

Press the IFX area to jump to the IFX Routing page.

Press the MFX/TFX area to jump to the MFX Routing page.

**KARMA GE Name**

This shows the name of the selected KARMA GE.

Press this area to jump to the GE Setup/Key Zones page.



## Program P4: Main

### 4-1: Main

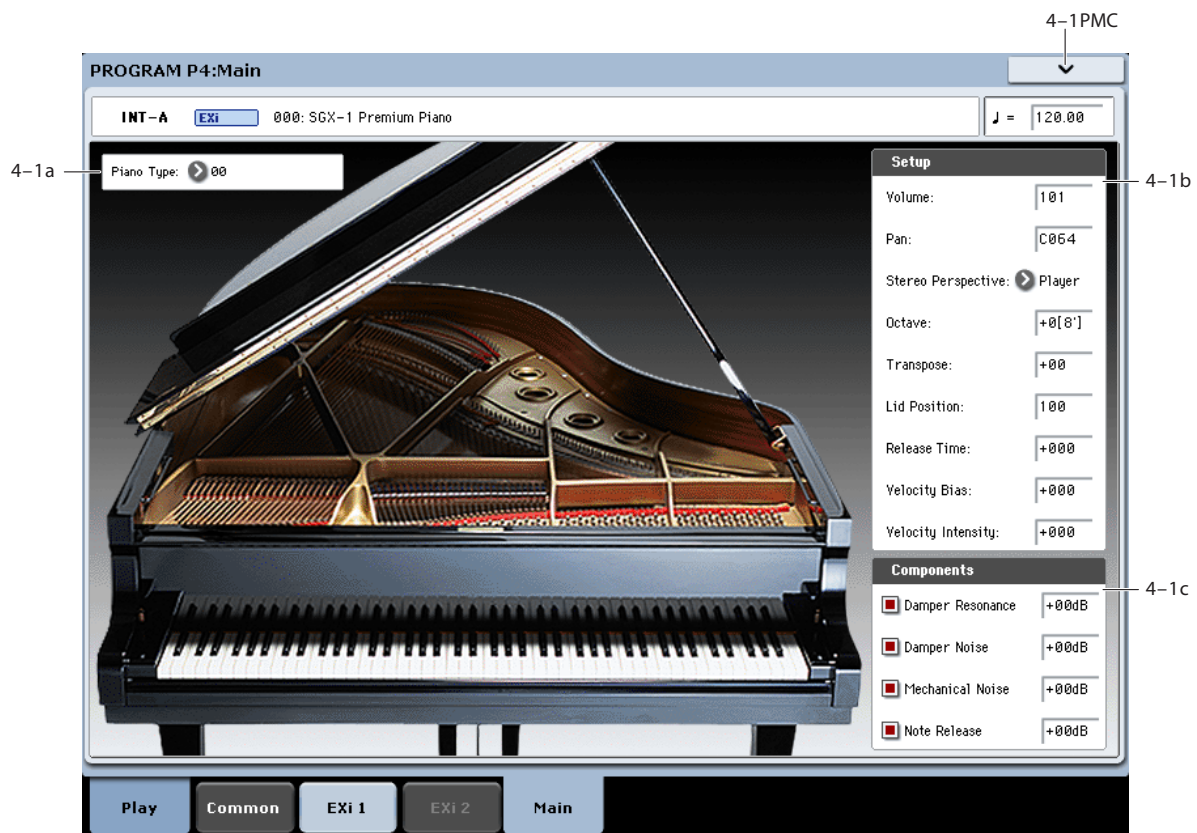

#### 4-1a: Piano Type

##### Piano Type [List]

The **Piano Type** selects the basic sound character, like selecting which of several pianos to play. The other parameters, such as **Velocity Bias**, **Lid Position**, and so on, let you make fine adjustments to the sound to suit your taste and touch.

More technically, the **Piano Type** controls the sample selection, the way that the samples are laid out across the keyboard and velocity ranges, and the many internal parameters which control how the samples are played.

If the **Piano Type** uses Multisamples which are not loaded, the Samples Not Loaded message will appear at the top of the display. You can load the required samples in Disk mode.

When the **Piano Type** is changed, other parameters remain unaffected.

Generally, an "s" after the **Piano Type** name indicates that the original stretch tuning of the piano was used.

#### 4-1b: Setup

##### Volume [0...127]

This controls the overall volume of the piano. It's the same as the standard EXi Volume on the Control Surface; changes in one place are reflected in the other.

##### Pan [Random, L001...C064...R127]

This controls the stereo position of the piano, "leaning" the original stereo image to the left or right as desired. A setting of C064 maintains the original stereo image; L001 places the sound at the far left, and R127 at the far right.

When this is set to **Random**, the pan position will change at each note-on. All notes will be change to the new position, so this is for special effects only.

You can also set the Pan directly from the Control Surface knobs. To do so:

1. Press the Control Surface Timbre/Track button.
2. Set the MIXER KNOBS switch to INDIVIDUAL PAN.
3. Move Knob 1 to set the pan for EXi 1, and Knob 2 to set the pan for EXi 2.

The on-screen parameter and the Control Surface pan are one and the same; changes in one place are reflected in the other.

**MIDI** You can also control pan via MIDI Pan (CC#10). A CC#10 value of 0 or 1 places the sound at the far left, 64 places the sound at the location specified by the **Pan** parameter, and 127 places the sound at the far right.

*Note:* you can select Random pan only from the on-screen UI, and not from MIDI or the Control Surface.

**Stereo Perspective** [Player, Audience]

This controls the left/right perspective of the piano. You can choose to hear the sound either as you would in the playing position or as someone listening on the other side of the piano.

**Player** puts the bass notes on the left.

**Audience** puts the bass notes on the right.

**Octave** [-2...+0...+1]

This transposes the piano in octaves. The default is +0.

**Transpose** [-12...+12]

This adjusts the pitch in semitones, over a range of ±1 octave.

**Lid Position** [0...+100]

Opening and closing the lid controls the overall brightness of the piano. 0 is fully closed, 50 is the normal position, and 100 is fully open. The on-screen graphic reflects this setting, with four different graphics from fully closed to fully open.

**MIDI** You can also scale the **Lid Position** via MIDI CC#74.

**Release Time** [-100...0...+100]

This scales the piano's release time—the time that it takes the note to ring out after you release the key (not including effects such as delay and reverberation).

0 is the default, and reflects the preset release time of the selected **Piano Type**.

-100 sets the release time to the minimum time, and +100 sets it to the maximum time.

**MIDI** You can also scale the **Release Time** via MIDI CC#72.

**Velocity Bias** [-100...0...+100]

This alters the velocity response by compressing one part of the range while expanding the other, creating a "darker" or "brighter" overall effect while maintaining the full velocity range from ppp to fff. Note that this affects timbre only—not volume.

Velocity Bias

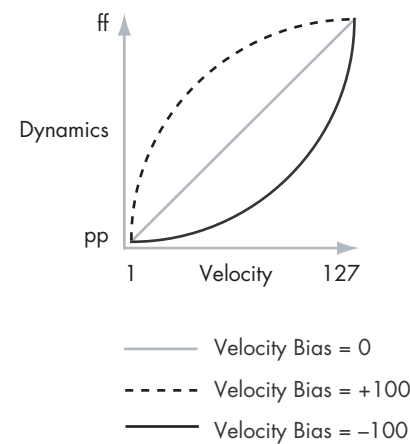

**Velocity Intensity** [-100...0...+100]

This scales velocity modulation of volume. Other effects of velocity, such as brightness, sample selection, and so on, are unaffected.

0 is the default, and reflects the preset velocity intensity of the selected **Piano Type**.

-100 removes the velocity modulation entirely. +100 means maximum modulation in the same direction, positive or negative, as the original **Piano Type**.

**4-1c: Components**

**Damper Resonance** [Off, On]

Pressing down the damper pedal lifts the felt dampers from all of the strings across the keyboard, allowing them to resonate freely. In this state, playing any note causes the rest of the strings to vibrate slightly, creating a rich, complex resonance. A similar but softer effect is produced by first playing and holding a note, and then pressing down the damper pedal. The SGX-1 models these behaviors.

This parameter controls the triggering of new **Damper Resonance** samples. Editing the parameter does not affect currently sounding notes.

**Level** [-48 dB...+6 dB]

This sets the volume level for the **Damper Resonance** samples.

The level is adjusted in steps of 1dB. This also applies to the other Level parameters, below.

**Damper Noise** [Off, On]

When the damper pedal is pressed down, the noise of the impact causes all of the strings to resonate slightly. If you press down the damper quickly, the noise will be more prominent; if you press down slowly, it will be softer.

This parameter controls the triggering of new **Damper Noise** samples. Changes take effect the next time that you press down the damper pedal.

**Level** [-48 dB...+6 dB]

This controls the volume level of the **Damper Noise**.

As with the On/Off parameter above, changes to Level do not affect currently sounding **Damper Noise** samples.

**Mechanical Noise** [Off, On]

This is the mechanical sound of the key being released.

This parameter controls the triggering of new **Mechanical Noise** samples. Changing it does not affect keys which have already been released.

**Level** [-48 dB...+6 dB]

This controls the level of the **Mechanical Noise**.

As with the On/Off parameter above, changes to Level do not affect currently sounding **Mechanical Noise** samples.

**Note Release** [Off, On]

This is the sound of the damper hitting the string. If the damper pedal is not used, this happens at the same time as the **Mechanical Noise**, above. If the damper pedal is being used, it happens when the damper pedal is released—which may be some time after the key is released.

This parameter controls the triggering of new **Note Release** samples. Changing it does not affect notes which have already been released.

**Level** [-48 dB...+6 dB]

This sets the volume level for **Note Release** samples.

As with the On/Off parameter above, changes to Level do not affect currently sounding **Note Release** samples.

## SGX-1: Tone adjust

SGX-1 Tone Adjust Default Settings

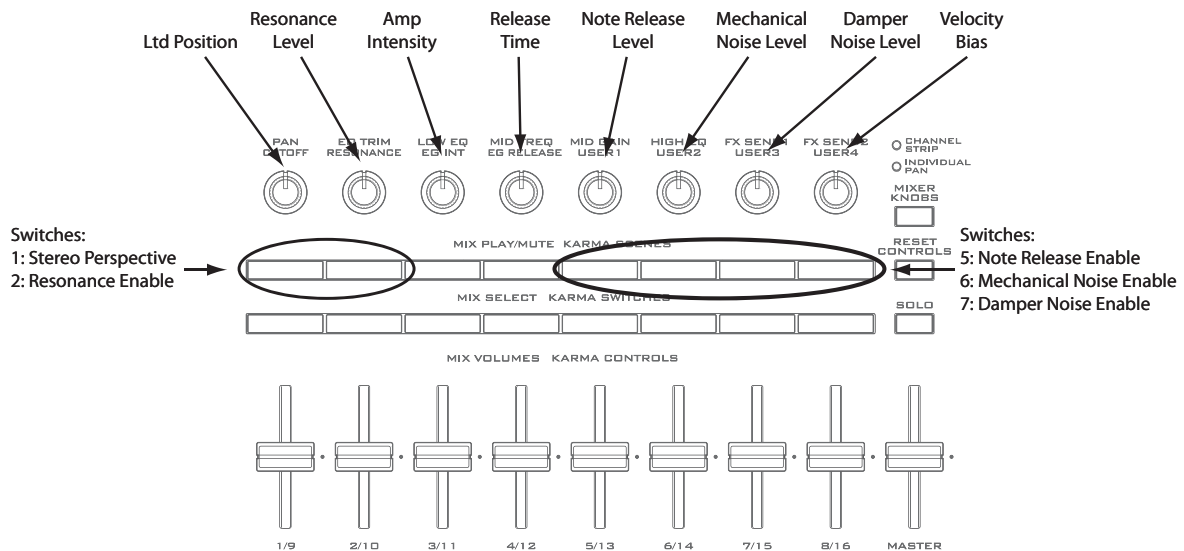

### Common Tone Adjust parameters

The SGX-1 supports the following Common Tone Adjust parameters:

**Off.** This means that the Tone Adjust control has no effect.

**Filter Cutoff.** (–99...+99, CC#74, Relative)  
This scales the **Lid Position**.

**Amp Velocity Intensity.** (–99...+99, Relative)  
This scales the effect of velocity on volume.

–99 removes the velocity modulation entirely. +99 means maximum modulation in the same direction, positive or negative, as the original Program.

**Filter/Amp EG Release Time.**  
(–99...+99, CC#72, Relative)  
This scales the **Release Time**.

**Common LFO Speed.** (–99...+99, Relative)  
This scales the EXi Program's Common LFO **Frequency**. When the LFO is in MIDI/Tempo mode, this adjusts the **Base Note**.

**Unison.** (Off/On, Absolute)  
This **Absolute** parameter turns the EXi Program's **Unison** parameter on and off. For more information, please see "Unison" on page 38.

**Number Of Voices.** (2...16, Absolute)  
This **Absolute** parameter sets the number of Unison voices. If **Unison** is not **On**, this parameter has no effect. For more information, please see "Number of voices" on page 38.

**Detune.** (0...200, Absolute)  
This **Absolute** parameter sets amount of detuning between the Unison voices. If **Unison** is not **On**, this parameter has no effect. For more information, please see "Detune" on page 38.

**Thickness.** (Off/01...09, Absolute)

This **Absolute** parameter sets the pattern of detuning between the Unison voices. If **Unison** is not **On**, or if **Detune** is set to 0, this parameter has no effect. For more information, please see "Thickness" on page 39.

**Common Step Sequencer Attack Smoothing.** (00...99, Absolute)

This **Absolute** parameter sets amount of attack smoothing for the Common Step Sequencer. For more information, please see "Smoothing" on page 178.

**Common Step Sequencer Decay Smoothing.** (00...99, Absolute)

This **Absolute** parameter sets amount of decay smoothing for the Common Step Sequencer. For more information, please see "Smoothing" on page 178.

### SGX-1 Tone Adjust parameters

In addition to the Common Tone Adjust parameters listed above, the SGX-1 adds a number of its own parameters.

Note that these additional parameters are separate for each EXi, as opposed to being shared by both EXi in the Program.

All of the SGX-1 Tone Adjust parameters are of the **Absolute** type, which directly correspond to the main parameter values.

The full name of the currently selected parameter is shown in the status line at the top of the Control Surface page, as well as in the popup menu. Some parameters with longer names may show an abbreviation for the slider, knob, and switch labels.

#### Setup

Volume

Pan

Velocity Bias

Lid Position

Stereo Perspective

Transpose

Velocity Intensity

Release Time

**Components**

Damper Resonance Enable

Damper Resonance Level

Note Release Enable

Note Release Level

Mechanical Noise Enable

Mechanical Noise Level

Damper Noise Enable

Damper Noise Level

# EXi: EP-1 MDS Electric Piano

## EP-1 Overview

### New technology, classic sounds

The EP-1 provides incredible recreations of six classic tine and reed electric pianos, along with modeled vintage effects. Based on Korg's Multi-Dimensional Synthesis (MDS), the EP-1 delivers natural real-time expression without the limitations of ordinary sample playback. For instance, you'll appreciate the astonishingly smooth gradation of dynamics from pp to ff, without tell-tale split points - just like the real instruments.

Real-time control over noise elements, including mechanical key-off noises controlled by release velocity, gives your performances even greater realism and detail.

The EP-1 offers a maximum of 104 voices of polyphony.

### Multi-Dimensional Synthesis (MDS)

MDS is a brand-new technology from Korg. To create the EP-1 models, we first sample the instrument at many different dynamic levels and pitches. Next, we separate the main pitched sound from the hammer and key release noises, so that you have separate control over each. Finally, we use proprietary techniques to transform all of these elements into an MDS sound.

The result delivers natural control over both the velocity and time "dimensions." Velocity becomes a continuous transition from soft to loud and sweet to

strong, without the telltale velocity-switching of traditional sample playback. Time becomes flexible, so that you can control the decay and release in a natural way, without resorting to volume or filter envelopes.

### Other notes

#### EP-1 uses EXi fixed resources

The EP-1's amp and effects take up a little processing power even if you're not playing any notes on the keyboard. This amount is slightly less than half that of the CX-3; in Combinations or Songs, you can use a maximum of 18 EP-1s at once. Each EXi in each Program counts towards the maximum; for instance, a Program with two EP-1's counts as two, not as one.

For more information, see "CX-3 & other EXi: Limitations on EXi fixed resources" on page 420.

#### Unsupported EXi Common parameters

The EP-1 supports most of the EXi Common parameters, except for the voice allocation options detailed below:

- **Poly Legato**
- **Mono Mode (Normal or Use Legato Offset)**
- **Unison**, including **Number of Voices**, **Detune**, and **Thickness**

Note also that for Reed EPs, **Hold** is always on at G#6 and higher.

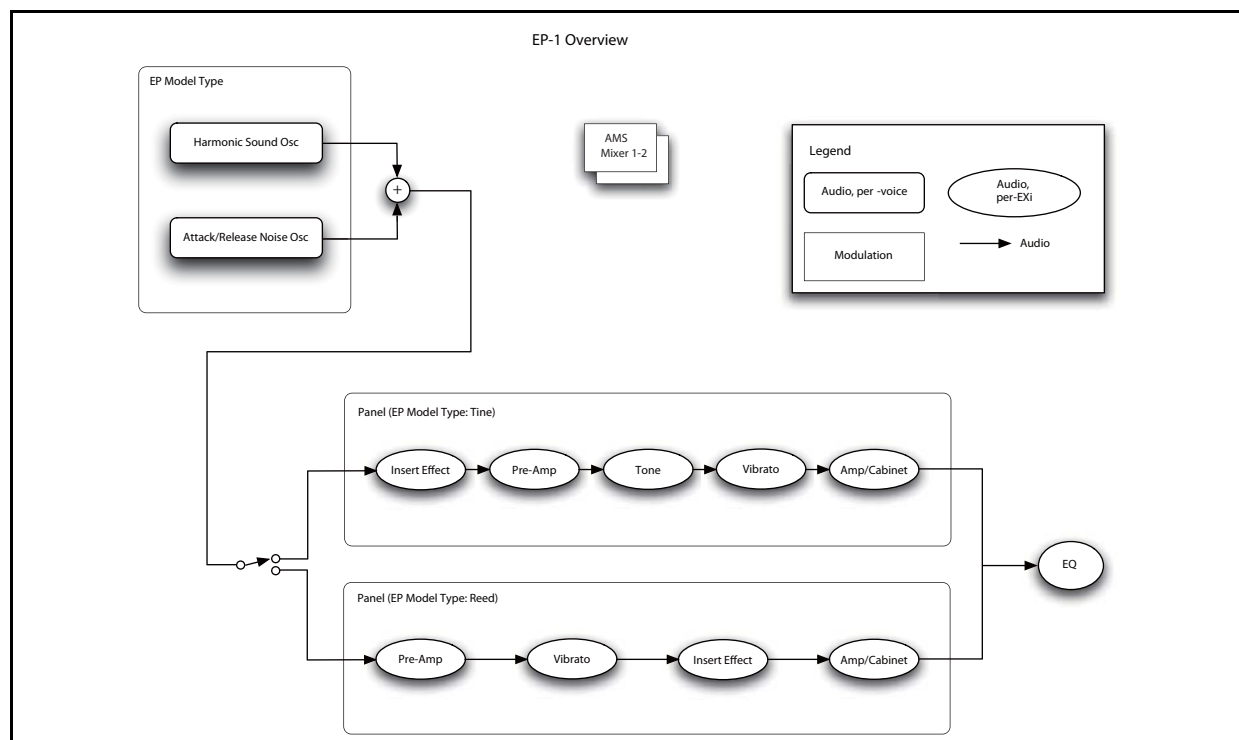

---

## On-screen knobs, sliders & switches and the Parameter Details area

---

### Parameter Details

The LCD displays include graphic knobs for all of the main EP-1 parameters. These let you view and edit parameters quickly and easily.

You can program any sound from the original electric pianos using only these knobs. If you want more flexibility and control, however, the EP-1 two AMS mixers, access to the EXi Program's Common LFO, Common Step Sequencer, and Vector features, and AMS modulation for almost every original knob, slider, and switch.

The entryway to these advanced features is the Parameter Details area, located in the lower right-hand part of the screen. This shows information for the selected knob or switch, including its parameter group and parameter name, its exact value, and its AMS assignments:

---

### Using the graphic parameters

#### Editing knobs and sliders

To edit knobs and sliders:

1. **Touch the knob or slider.**

A yellow square will appear around the control, showing that it has been selected. The Parameter Details area will change to show the name and value of the current parameter, along with other related information.

2. **Use any of the data-entry controls to edit the value.**

You can use the value slider, the inc/dec buttons, the rotary dial, or the numeric keypad.

As you edit the value, notice that the graphic knob or slider moves, and that the value in the Parameter Details area changes as well.

#### Editing on/off switches

To edit an on/off switch, such as the **VIBRATO ON/OFF** switch, simply:

1. **Touch the switch to toggle the value.**

---

### Assigning AMS modulation

Most parameters support modulation via AMS. Sources and intensities can be edited in the Parameter Details area:

1. **Touch the knob.**

If the parameter supports AMS modulation, the Parameter Details area will show the AMS source and intensity settings.

2. **Edit the AMS settings in the Parameter Details area.**

**Note:** the graphic knobs always show their stored value. Absolute Tone Adjust settings edit these values, just as if you were editing the parameters themselves, and so the graphics will show the results. However, AMS modulation does not edit the stored value, and so the graphics do not include the results of AMS.



## EXi Program P0: Play

### 0-1: Main



This is the main page of Program mode. For a full description of this page and all of its functions, please see “EXi Program P0: Play” on page 165. This section describes only the overview display, which differs for each individual EXi.

#### 0-1b: Overview and Page Jump

This part of the page shows an overview of the most important settings for the Program’s two EXi instruments. The specific parameters will vary, depending on which EXi are being used.

The graphics give you a quick way to check all of these settings at a glance. They also let you jump instantly to any of the displayed parameters. Just touch one of the graphics, and you’ll jump to the page containing its parameters.

*Tip:* Pressing EXIT several times will always bring you back to this page.

#### Model Type

This shows the selected Model Type—Tine EP1, Reed EP 200A, etc.—which controls the basic sound of the EP-1. Touch this area to jump to the EP-1’s Basic/Oscillator page. For more information, see “Program P4: Basic/Oscillator” on page 399.

#### Panel, amp, and effects

This section shows the EP’s front panel settings, the selected effect, and the cabinet (if enabled). Touch this area to jump to the EP-1’s Panel/IFX/Amp & Cabinet page. For more information, see “Program P5: Panel/IFX/Amp & Cabinet” on page 403.

#### Common Key Zone

This shows the key zones for EXi1 and EXi2, as set on the Common section’s Program Basic page, in relation to the entire MIDI note range. The range of the 61-, 73-, or 88-note keyboard is also shown, as appropriate.

Press this area to jump to the Program Basic page.

#### Common

The graphics along the right side of the screen show the most important Common parameters, which are shared by both EXi in the Program. This section will always show the same parameters, regardless of which EXi are being used.

#### Common Voice Assign Mode

This shows the voice assign mode of the Program—either POLY or MONO.

Press this area to jump to the Program Basic page.

#### Common Step Sequencer

This shows a graphic overview of the Common Step Sequencer.

Press this area to jump to the Common Step Sequencer page.

#### Common LFO Graphic

This shows the waveform of the Common LFO.

Press this area to jump to the Common LFO page.

#### 3 Band EQ Graphic

This shows the mid-sweepable 3-band EQ.

Press this area to jump to the EQ page.

**IFX, MFX/TFX**

Press the IFX area to jump to the IFX Routing page.

Press the MFX/TFX area to jump to the MFX Routing page.

**KARMA GE Name**

This shows the name of the selected KARMA GE.

Press this area to jump to the GE Setup/Key Zones page.

# Program P4: Basic/Oscillator

## P4-1 Basic

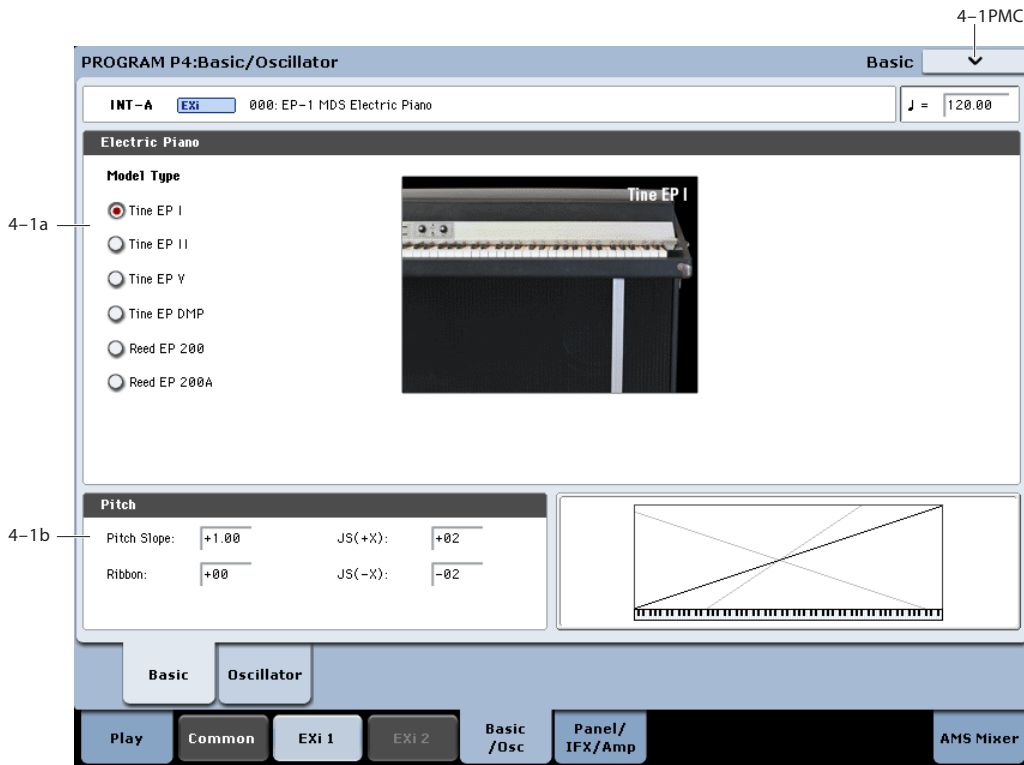

### 4-1a: Electric Piano

**Model Type** [Tine EP I, Tine EP II, Tine EP V, Tine EP DMP, Reed EP 200, Reed EP 200A]

This selects the electric piano model. It mirrors the similar control on P5; changes in one place are reflected in the other. There are two basic types, Tine and Reed, reflecting the two standard electric piano technologies. Without getting too specific, Reed pianos are “whirly” and Tine pianos may take you down familiar “roads.”

For more information, see “Tine EP,” beginning on page 405 and “Reed EP,” beginning on page 407.

### 4-1b: Pitch

**Pitch Slope** [-1.0...+2.0]

**Positive (+)** values cause the pitch to rise as you play higher on the keyboard, and **negative (-)** values cause the pitch to *fall* as you play higher on the keyboard.

Normally, this should be set to the default of +1.0.

When **Pitch Slope** is set to 0, playing different notes on the keyboard won’t change the pitch at all; it will be as if you’re always playing C4. This can be useful for special effects sounds, for instance.

Pitch Slope, pitch, and note

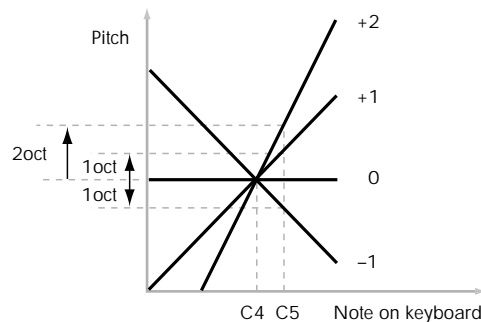

**Ribbon** [-60...+60]

You can use the ribbon controller for pitch-bend. This parameter sets the range of the ribbon’s pitch-bend, in semitones.

**Positive (+)** values make the pitch rise when you press the ribbon controller to the right of center, and **negative (-)** values will cause the pitch to fall.

For example, with a setting of +12, pressing the far right edge of the ribbon controller will raise the pitch one octave, and pressing the far left edge will lower the pitch by one octave.

With a setting of -12, the effect is reversed; pressing on the right edge will *lower* the pitch, and pressing on the left will *raise* the pitch.

When you lift off of the ribbon, the pitch will snap back to the center (unless you're using the SW1/2 "Ribbon Lock" feature). So, by tapping on the right edge of the ribbon and then releasing quickly, you can create guitar "hammer-on" effects.

**JS (+X) [-60...+12]**

This sets the maximum amount of pitch bend, in semitones, when you move the joystick to the right. For normal pitch bend, set this to a positive value.

For example, if you set this to **+12** and move the joystick all the way to the right, the pitch will rise one octave above the original pitch.

**JS (-X) [-60...+12]**

This sets the maximum amount of pitch bend, in semitones, when you move the joystick to the left. For normal pitch bend, set this to a negative value.

For example, if you set this to **-60** and move the joystick all the way to the left, the pitch will fall five octaves below the original pitch. You can use this to create guitar-style downward swoops.

---

**▼ 4-1: Page Menu Commands**

The number before each command shows its ENTER + number-key shortcut. For more information on these shortcuts, see "ENTER + 0-9: shortcuts for menu commands" on page 147.

- **0: Write Program.** For more information, see "Write Program" on page 147.
- **1: Exclusive Solo.** For more information, see "Exclusive Solo" on page 147.

## P4-2 Oscillator

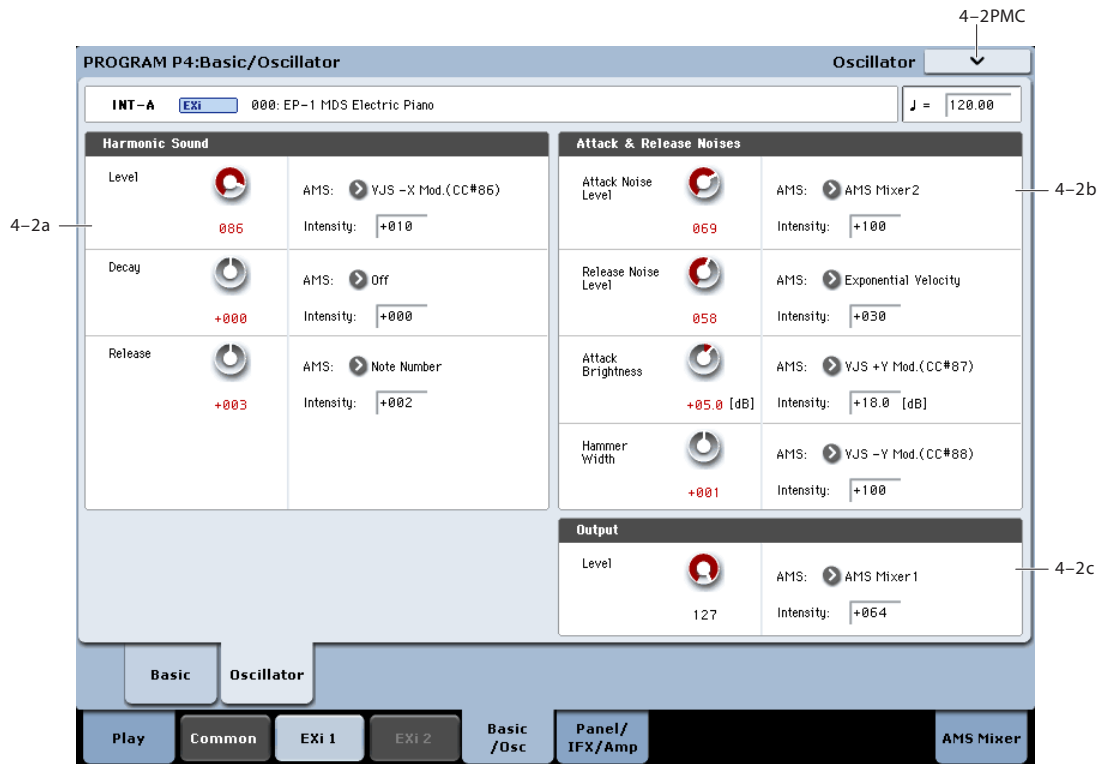

### 4-2a: Harmonic Sound

**Level** [000...100]

This controls the volume level of the main pitched part of the sound.

**AMS** [List of AMS Sources]

This selects an AMS source to control the **Harmonic Sound Level**. For a list of AMS sources, see “Alternate Modulation Source (AMS) List” on page 1091.

**Intensity** [-100...+100]

This controls the depth and direction of the **Harmonic Sound Level** AMS modulation.

**Decay** [-100...+100]

This controls the decay time, including both the timbre and the level.

**AMS** [List of AMS Sources]

This selects an AMS source to control the **Decay**. For a list of AMS sources, see “Alternate Modulation Source (AMS) List” on page 1091.

**Intensity** [-100...+100]

This controls the depth and direction of the **Decay** AMS modulation.

**Release** [-100...+100]

This controls the release time, including both the timbre and the level.

**AMS** [List of AMS Sources]

This selects an AMS source to control the **Release**. For a list of AMS sources, see “Alternate Modulation Source (AMS) List” on page 1091.

**Intensity** [-100...+100]

This controls the depth and direction of the **Release** AMS modulation.

### 4-2b: Attack & Release Noises

**Attack Noise Level** [0...100]

This controls the volume level of the attack noise.

**AMS** [List of AMS Sources]

This selects an AMS source to control the **Attack Noise Level**. For a list of AMS sources, see “Alternate Modulation Source (AMS) List” on page 1091.

**Intensity** [-100...+100]

This controls the depth and direction of the **Attack Noise Level** AMS modulation.

**Release Noise Level** [0...100]

This controls the volume level of the release noise. This level is also scaled by the volume of the harmonic sound at the time of release.

**AMS** [List of AMS Sources]

This selects an AMS source to control the **Release Noise Level**. For a list of AMS sources, see “Alternate Modulation Source (AMS) List” on page 1091.

**Intensity** [-100...+100]

This controls the depth and direction of the **Release Noise Level** AMS modulation.

**Attack Brightness** [-18.0...+00.0...+18.0]

This controls the brightness of the attack noise.

**AMS** [List of AMS Sources]

This selects an AMS source to control the **Tone**. For a list of AMS sources, see "Alternate Modulation Source (AMS) List" on page 1091.

**Intensity** [-18.0...+00.0...+18.0]

This controls the depth and direction of the **Tone** AMS modulation.

**Hammer Width** [-100...+100]

This controls the width of the hammer.

**AMS** [List of AMS Sources]

This selects an AMS source to control the **Hammer Width**. For a list of AMS sources, see "Alternate Modulation Source (AMS) List" on page 1091.

**Intensity** [-100...+100]

This controls the depth and direction of the **Hammer Width** AMS modulation.

---

## 4-2c: Output

**Level** [0...127]

This controls the overall output level.

**AMS** [List of AMS Sources]

This selects an AMS source to control the **Level**. For a list of AMS sources, see "Alternate Modulation Source (AMS) List" on page 1091.

**Intensity** [-99...+99]

This controls the depth and direction of the **Level** AMS modulation.

---

## ▼ 4-2: Page Menu Commands

The number before each command shows its ENTER + number-key shortcut. For more information on these shortcuts, see "ENTER + 0-9: shortcuts for menu commands" on page 147.

- 0: **Write Program**. For more information, see "Write Program" on page 147.
- 1: **Exclusive Solo**. For more information, see "Exclusive Solo" on page 147.

## Program P5: Panel/IFX/Amp & Cabinet

### P5-1 Common

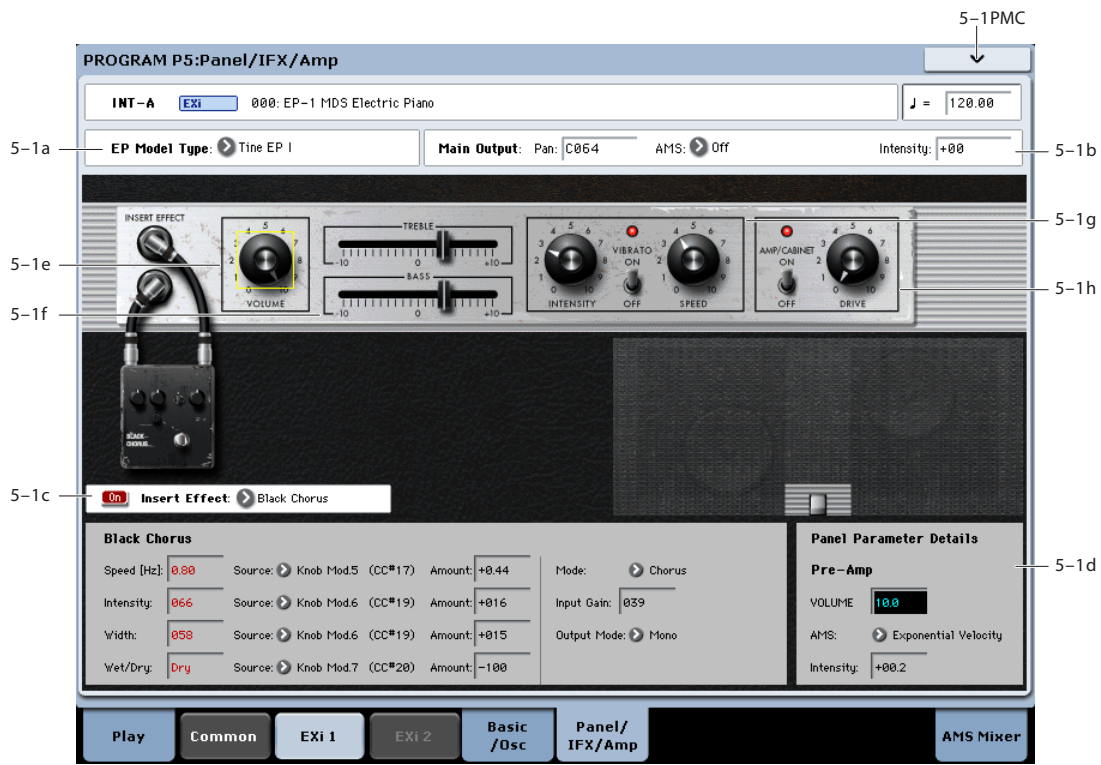

#### 5-1a: Model Type

**EP Model Type** [Tine EP I, Tine EP II, Tine EP V, Tine EP DMP, Reed EP 200, Reed EP 200A]

This selects the electric piano model. It mirrors the similar control on P4; changes in one place are reflected in the other. There are two basic types, Tine and Reed, reflecting the two standard electric piano technologies. Without getting too specific, Reed pianos are “whirly” and Tine pianos may take you down familiar “roads.”

When you change between Tine and Reed types, the control panel will change as well; the two types have slightly different features. For detailed information on the panel parameters, see “Tine EP,” below, and “Reed EP,” beginning on page 407.

#### 5-1b: Main Output

Note that volume is controlled on the panel, below.

**Pan** [Random, L001...C064...R127]

This controls the stereo position of the piano, “leaning” the stereo image to the left or right as desired. A setting of C064 maintains the original stereo image; L001 places the sound at the far left, and R127 at the far right.

When this is set to **Random**, the pan position will change at each note-on. All notes will be change to the new position, so this is for special effects only.

You can also set the Pan directly from the Control Surface knobs. To do so:

1. Press the Control Surface Timbre/Track button.
2. Set the MIXER KNOBS switch to INDIVIDUAL PAN.
3. Move Knob 1 to set the pan for EXi 1, and Knob 2 to set the pan for EXi 2.

The on-screen parameter and the Control Surface pan are one and the same; changes in one place are reflected in the other.

**MIDI** You can also control pan via MIDI Pan (CC#10). A CC#10 value of 0 or 1 places the sound at the far left, 64 places the sound at the location specified by the **Pan** parameter, and 127 places the sound at the far right.

*Note:* you can select Random pan only from the on-screen UI, and not from MIDI or the Control surface.



---

## 5-1c: Insert Effect

**Type** [Off, Small Phase, Orange Phase, Black Phase, Vintage Chorus, Black Chorus, EP Chorus, Vintage Flanger, Red Comp, VOX Wah]

This selects the pedal to use for the insert effect. The effect's parameters appear in the panel below. For information on the individual effects, see "Insert Effects," beginning on page 408.

**(Insert Effect Enable)** [On, Off]

This button turns the insert effect on and off. You can use this to temporarily bypass the effect, for instance.

---

## 5-1d: Parameter Details

When you touch a knob, slider, or switch on the panel graphic, a yellow square appears around it to show that it has been selected.

This area shows details for the selected control, including its name, value, and AMS assignments.

**(Parameter name)** [range depends on parameter]

This shows the name and exact value of the parameter. You can edit the parameter value with any of the standard data-entry controls.

**AMS** [List of AMS Sources]

This selects a modulation source to control the selected parameter. For a list of AMS sources, see "Alternate Modulation Source (AMS) List" on page 1091.

**Intensity** [range depends on parameter]

This controls the depth and direction of the AMS modulation. For unipolar parameters, the range is usually the same as that of the selected parameter, in both positive and negative directions. For instance, if the parameter range is 0.0...10.0, the Intensity range will generally be -10.0...+10.0.

---

## ▼ 5-1: Page Menu Commands

The number before each command shows its ENTER + number-key shortcut. For more information on these shortcuts, see "ENTER + 0-9: shortcuts for menu commands" on page 147.

- 0: **Write Program**. For more information, see "Write Program" on page 147.
- 1: **Exclusive Solo**. For more information, see "Exclusive Solo" on page 147.

## Tine EP



These parameters apply when one of the Tine pianos is selected as the EP Model Type.

### 5-1e: Pre-amp

**VOLUME** [0...10.0]

This controls the volume level of the preamp. The default is 8.0.

**AMS** [List of AMS Sources]

This selects an AMS source to control the VOLUME. For a list of AMS sources, see "Alternate Modulation Source (AMS) List" on page 1091.

**Intensity** [-10.0...+10.0]

This controls the depth and direction of the VOLUME AMS modulation.

### 5-1f: Tone

**TREBLE** [-10.0...+10.0]

This controls the high-frequency boost or cut.

**AMS** [List of AMS Sources]

This selects an AMS source to control the TREBLE setting. For a list of AMS sources, see "Alternate Modulation Source (AMS) List" on page 1091.

**Intensity** [-10.0...+10.0]

This controls the depth and direction of the TREBLE AMS modulation.

**BASS** [-10.0...+10.0]

This controls the low-frequency boost or cut.

**AMS** [List of AMS Sources]

This selects an AMS source to control the BASS setting. For a list of AMS sources, see "Alternate Modulation Source (AMS) List" on page 1091.

**Intensity** [-10.0...+10.0]

This controls the depth and direction of the BASS AMS modulation.

### 5-1g: Vibrato

**ON/OFF** [On, Off]

This enables the Vibrato effect.

**AMS** [List of AMS Sources]

This selects an AMS source to turn the vibrato on or off. For a list of AMS sources, see "Alternate Modulation Source (AMS) List" on page 1091.

**AMS Mode** [Toggle, Momentary]

This controls the way in which the vibrato ON/OFF AMS works.

When this is set to **Toggle**, the vibrato ON/OFF AMS will alternate between on and off. For instance, if vibrato is **OFF**, and **AMS** is assigned to a footswitch, the first press will turn on the Vibrato, and the next press will turn it off again.

**Momentary** means that the change happens only while the controller is enabled. Continuing the example from above, when the footswitch is pressed down, the Vibrato will turn on; when the footswitch is released, the Vibrato will turn off again.

AMS lets you switch to the opposite of the programmed setting. For instance, if vibrato is **ON**, and the **AMS Mode** is set to **Momentary**, then pressing down on the footswitch would turn off the Vibrato.

If you set AMS to use a continuous controller, such as the Joystick, values of 0-63 are as if the switch was off, and values of 64-127 are as if the switch was on.

Finally - note that the assignable switches, **SW1** and **SW2**, can themselves be set to either momentary or toggle modes, and these settings are reflected by the switch LEDs. Individual parameter mode settings, such as the vibrato **ON/OFF** AMS Mode, do *not* affect the LEDs.

So, if you're using SW1 or SW2 as the AMS source, it's best to set the AMS Mode to Momentary, and then just let the switch itself determine the momentary/toggle behavior.

**SPEED** [00.0...10.0]

This controls the rate of the Vibrato effect. The default is 5.0.

**AMS** [List of AMS Sources]

This selects an AMS source to control the **SPEED**. For a list of AMS sources, see "Alternate Modulation Source (AMS) List" on page 1091.

**Intensity** [-10.0...+10.0]

This controls the depth and direction of the **SPEED** AMS modulation.

**INTENSITY** [00.0...10.0]

Not to be confused with AMS Intensity, this knob (named the same as on the original instrument) controls the depth of the Vibrato effect. The default is 5.0.

**AMS** [List of AMS Sources]

This selects an AMS source to control the **Intensity**. For a list of AMS sources, see "Alternate Modulation Source (AMS) List" on page 1091.

**Intensity** [-10.0...+10.0]

This controls the depth and direction of the **Intensity** AMS modulation.

---

**5-1h: Amp & Cabinet****ON/OFF** [On, Off]

This enables the amp and cabinet modeling.

**AMS** [List of AMS Sources]

This selects an AMS source to turn the amp and cabinet model on or off. For a list of AMS sources, see "Alternate Modulation Source (AMS) List" on page 1091.

**AMS Mode** [Toggle, Momentary]

This controls the way in which the amp and cabinet **Enable** AMS works. For more details, see "AMS Mode" on page 405.

**DRIVE** [00.0...10.0]

This controls the amount of overdrive and distortion in the amp. At lower settings, the amp is very clean; as you increase the **DRIVE**, it gets dirtier and more distorted. The output level is compensated, so increasing **DRIVE** causes only a moderate increase in perceived volume.

**AMS** [List of AMS Sources]

This selects an AMS source to control the **DRIVE**. For a list of AMS sources, see "Alternate Modulation Source (AMS) List" on page 1091.

**Intensity** [-10.0...+10.0]

This controls the depth and direction of the **DRIVE** AMS modulation.

## Reed EP



These parameters apply when the EP Model Type is set to either **Reed 200** or **Reed 200a**.

### 5-1i: Pre-amp

**VOLUME** [00.0...10.0]

This controls the volume level. The default is 8.0.

**AMS** [List of AMS Sources]

This selects an AMS source to control the **VOLUME**. For a list of AMS sources, see “Alternate Modulation Source (AMS) List” on page 1091.

**Intensity** [-10.0...+10.0]

This controls the depth and direction of the **VOLUME** AMS modulation.

### 5-1j: Vibrato

**INTENSITY** [00.0...10.0]

This controls the depth of the vibrato effect. To turn off the vibrato completely, set **INTENSITY** to 00.0. (The original instrument had only a knob, without a separate on/off switch.)

**AMS** [List of AMS Sources]

This selects an AMS source to control the **INTENSITY**. For a list of AMS sources, see “Alternate Modulation Source (AMS) List” on page 1091.

**Intensity** [-10.0...+10.0]

This controls the depth and direction of the **INTENSITY** AMS modulation.

**SPEED** [00.0...10.0]

This controls the rate of the vibrato effect. On the original instrument, **SPEED** wasn’t adjustable; 5.0 on this knob matches the original value.

**AMS** [List of AMS Sources]

This selects an AMS source to control the **SPEED**. For a list of AMS sources, see “Alternate Modulation Source (AMS) List” on page 1091.

**Intensity** [-10.0...+10.0]

This controls the depth and direction of the **SPEED** AMS modulation.

### 5-1k: Amp & Cabinet

This section is the same as for the **Tine Piano**, as described under “5-1h: Amp & Cabinet” on page 406.

## Insert Effects

The parameters vary depending on the selected effect.

### Small Phase

This classic phaser, made in New York City during the 70s, has a notably warm and rich tone with liquid transparency.

**Speed [Hz]** [0.10...10.00]

This controls the speed of the phaser's LFO. The default is 0.56 Hz.

**Source** [List of Dmod Sources]

This selects a mod source to control the **Speed**. For a list of Dmod sources, see the "Dynamic Modulation Source List" on page 1101.

**Amount** [-10.0...+10.0]

This controls the depth and direction of the **Speed** modulation.

**Color** [Off, On]

This changes the sound of the phaser between a full and round phase shift when set to **Off**, and a more pronounced effect when set to **On**.

### OUTPUT

**Wet/Dry**  [Dry, 1:99...99:1, Wet]

Sets the balance between the "wet" processed sound and the dry input.

**Source** [List of Dmod Sources]

This selects a modulation source to control the **Wet/Dry** balance.

**Amount** [-100...+100]

This controls the depth and direction of the **Wet/Dry** modulation.

### Orange Phase

This phaser pedal is a favorite on many recordings. It's useful for adding sparkle, animating chord passages, and widening and fattening the sound.

The original had only a speed control; this version adds depth, control of the center frequency, and more.

**Speed [Hz]** [0.10...10.00]

This controls the speed of the phaser's LFO. The default is 1.00 Hz.

**Source** [List of Dmod Sources]

This selects a modulation source to control the **Speed**. For a list of Dmod sources, see the "Dynamic Modulation Source List" on page 1101.

**Amount** [-10.0...+10.0]

This controls the depth and direction of the **Speed** modulation.

**Depth**  [0...100]

Sets the depth of LFO modulation.

**Source** [List of Dmod Sources]

This selects a modulation source to control the LFO modulation **Depth**.

**Amount** [-100...+100]

This controls the depth and direction of the **Depth** modulation.

**Resonance** [000...100]

This controls the intensity of the phaser effect. The default is 26. Mixing the processed and dry signals via **Wet/Dry** will enhance the effect.

**Manual** [1...100]

This sets the center frequency of the phaser. The default is 45.

### OUTPUT

This is the standard effects output section, with modulatable control over wet/dry balance. For more information, see "OUTPUT" on page 408.

### Black Phase

Inspired by a classic European phaser pedal.

**Speed [Hz]** [0.10...10.00]

This controls the speed of the phaser's LFO. The default is 1.0Hz.

**Source** [List of Dmod Sources]

This selects a modulation source to control the **Speed**. For a list of Dmod sources, see the "Dynamic Modulation Source List" on page 1101.

**Amount** [-10.0...+10.0]

This controls the depth and direction of the **Speed** modulation.

**Depth**  [0...100]

Sets the depth of LFO modulation.

**Source** [List of Dmod Sources]

This selects a modulation source to control the LFO modulation **Depth**.

**Amount** [-100...+100]

This controls the depth and direction of the **Depth** modulation.

**Resonance** [000...100]

This controls the intensity of the phaser effect. The default is 26. Mixing the processed and dry signals via **Wet/Dry** will enhance the effect.

**Manual** [1...100]

This sets the center frequency of the phaser. The default is 45.

### OUTPUT

This is the standard effects output section, with modulatable control over wet/dry balance. For more information, see "OUTPUT" on page 408.

## Vintage Chorus

This models a chorus best-known for being built into a guitar amp. You can use the **Speed** and **Depth** knobs for an even broader range of possibilities than on the original device.

**Speed [Hz]** [0.10...10.00]

This controls the speed of the chorus' LFO. The default is 0.48 Hz.

**Source** [List of Dmod Sources]

This selects a modulation source to control the **Speed**. For a list of Dmod sources, see the "Dynamic Modulation Source List" on page 1101.

**Amount** [-10.0...+10.0]

This controls the depth and direction of the **Speed** modulation.

**Depth**  $D_{mod}$  [0...100]

Sets the depth of LFO modulation. The default is 58.

**Source** [List of Dmod Sources]

This selects a modulation source to control the **Depth**.

**Amount** [-100...+100]

This controls the depth and direction of the **Depth** modulation.

**Manual** [1...100]

This adjusts the offset of the LFO sweep, effectively increasing the center delay time of the chorus. The default is 1.

When **Depth** is set to the maximum of 100, this has no effect.

### OUTPUT

**Output Mode** [Mono, Stereo]

The chorus can function either in mono or stereo.

**Wet/Dry**  $D_{mod}$  [Dry, 1: 99...99:1, Wet]

Sets the balance between the "wet" processed sound and the dry input. The default is 50:50.

**Source** [Off...Tempo]

Selects a modulation source for **Wet/Dry**.

**Amount** [-100...+100]

Sets the modulation amount for **Wet/Dry**.

## Black Chorus

Modeled after a classic stereo chorus known for both crystal-clean tone and quiet operation, and especially well-suited to fine electric pianos.

**Speed [Hz]** [0.10...10.00]

This controls the speed of the LFO. The default is 0.8 Hz.

**Source** [List of Dmod Sources]

This selects a modulation source to control the **Speed**. For a list of Dmod sources, see the "Dynamic Modulation Source List" on page 1101.

**Amount** [-10.0...+10.0]

This controls the depth and direction of the **Speed** modulation.

**Intensity**  $D_{mod}$  [1...100]

This controls different things, depending on the **Mode** setting. The default is 66.

When **Mode** is set to Chorus, **Intensity** blends between the wet and dry signals.

When **Mode** is set to Pitch Modulation, **Intensity** blends between chorus (at 0) and vibrato (at 100).

When **Mode** is set to Flanger, **Intensity** controls the feedback amount.

**Source** [List of Dmod Sources]

This selects a modulation source to control the **Intensity**.

**Amount** [-100...+100]

This controls the depth and direction of the **Intensity** modulation.

**Width** [0...100]

This controls the amount of LFO modulation. The default is 58.

**Source** [List of Dmod Sources]

This selects a modulation source to control the **Width**.

**Amount** [-100...+100]

This controls the depth and direction of the **Width** modulation.

**Mode** [Chorus, Pitch Modulation, Flanger]

This controls the basic sound of the effect.

**Chorus** is a standard chorus sound.

**Pitch Modulation** is a lighter chorus effect.

**Flanger** adds feedback, for more extreme timbres.

**Input Gain** [0...100]

This controls the input into the effect. High levels will add saturation.

### OUTPUT

**Output Mode** [Mono, Stereo]

This controls whether the output is stereo or mono.

When set to **Stereo**, the left-right spread is controlled by the **Width** parameter.

**Wet/Dry**  **[Dry, 1: 99...99:1, Wet]**

Sets the balance between the “wet” processed sound and the dry input. The default is **Wet**.

Note: When **Mode** is set to **Chorus**, the Intensity control is the same as **Wet/Dry**.

**Source** **[List of Dmod Sources]**

Selects a modulation source for **Wet/Dry**.

**Amount** **[-100...+100]**

Sets the modulation amount for **Wet/Dry**.

**EP Chorus**

This is inspired by a rare chorus built into an early version of a famous modified tine piano.

**Speed [Hz]** **[0.10...10.00]**

This controls the speed of the chorus’ LFO. The default is 1.96 Hz.

**Source** **[List of Dmod Sources]**

This selects a modulation source to control the **Speed**. For a list of Dmod sources, see the “Dynamic Modulation Source List” on page 1101.

**Amount** **[-10.0...+10.0]**

This controls the depth and direction of the **Speed** modulation.

**Depth**  **[0...100]**

This sets the depth of LFO modulation. The default is 55.

**Source** **[List of Dmod Sources]**

This selects a modulation source to control the **Depth**.

**Amount** **[-100...+100]**

This controls the depth and direction of the **Depth** modulation.

**OUTPUT**

This is the standard effects output section, with modulatable control over wet/dry balance. For more information, see “OUTPUT” on page 408.

**Vintage Flanger**

A model of a truly classic analogue flanger. This amazing stompbox’s bucket-brigade technology provides a sweeping, whooshing sound, perfect for chords.

**Speed [Hz]** **[0.10...10.00]**

This controls the speed of the LFO. The default is 0.14Hz.

**Source** **[List of Dmod Sources]**

This selects a modulation source to control the **Speed**. For a list of Dmod sources, see the “Dynamic Modulation Source List” on page 1101.

**Amount** **[-10.0...+10.0]**

This controls the depth and direction of the **Speed** modulation.

**Depth**  **[0...100]**

Sets the depth of LFO modulation. The default is 71.

**Source** **[List of Dmod Sources]**

This selects a modulation source to control the **Depth**.

**Amount** **[-100...+100]**

This controls the depth and direction of the **Depth** modulation.

**Resonance** **[0...100]**

This controls the intensity of the flanger effect, via feedback. The default is 35.

**Manual** **[1...100]**

This adjusts the offset of the LFO sweep, effectively increasing the center delay time of the chorus. The default is 35.

When **Depth** is set to the maximum of 100, this has no effect.

**Source** **[List of Dmod Sources]**

This selects a modulation source to control the **Manual** amount.

**Amount** **[-100...+100]**

This controls the depth and direction of the **Manual** modulation.

**LFO Reset Source** **[List of Dmod Sources]**

This selects a modulation source to reset the LFO. You can use this to re-start the flanger’s jet-like, rolling motion just before a big power chord, for instance. This will be most useful when the **Speed** is set relatively low.

**Reset Offset Amount** **[0...100]**

This controls the phase of the LFO when reset.

**OUTPUT**

This is the standard effects output section, with modulatable control over wet/dry balance. For more information, see “OUTPUT” on page 408.

**Red Compressor**

Need to play clean chordal passages with smooth, even dynamics? Then, look no further: this compressor is modelled on a pedal whose clean sound made it hugely popular. Perfect for pop and funk music.

**Sensitivity** **[1...100]**

This controls the amount of compression. Increasing the value boosts lower level sounds, and raises the overall volume. The default is 50.

To adjust the final volume, use the **Output Level** parameter.

**Attack** **[1...100]**

This controls the onset time of the compressor. The default is 25.



**Level** [0...100]

Compression reduces the overall gain of the signal. This allows you to compensate for that effect, by boosting the gain again at the output. The default is 50.

**OUTPUT**

**Wet/Dry**  [Dry, 1:99...99:1, Wet]

Sets the balance between the “wet” processed sound and the dry input. The default is **Wet**.

**Source** [List of Dmod Sources]

Selects a modulation source for **Wet/Dry**.

**Amount** [-100...+100]

Sets the modulation amount for **Wet/Dry**.

**VOX Wah**

This effect is modeled on two legendary VOX wah pedals: the V847 and the V848 Clyde McCoy model. Thanks to their unique “throaty” tone, these are the only wah pedals that many professionals will consider putting under their feet. Played musically, they can make your melody lines cry like a baby—or howl like a man possessed!

A great tonal trick is to find a “sweet spot” within the range of the Wah pedal and then leave it there. This “stuck-Wah” can be very effective when used tastefully, producing a distinctive sound that will cut through any mix.

**Type** [V847, V848]

This selects the pedal model.

**V847** has a rounder sound; **V848** (the default) has a more aggressive sound.

**Open** [1...100]

This sets the wah frequency when the pedal is up. Notice that, if you like, you can set the **Open** value higher than the **Close** value. The default is 36.

**Close** [1...100]

This sets the wah frequency when the pedal is down. The default is 40.

**Mode** [Pedal Wah, Auto Wah]

This controls the basic operation of the wah, and also determines which parameters appear below.

**Auto Wah** makes the wah follow the input signal’s volume envelope. This is the default.

**Pedal Wah** lets you control the wah frequency directly via a modulation source, just like a wah pedal.

**Pedal Wah**

These parameters appear only when the **Mode** is set to **Pedal Wah**.

**Pedal Source** [List of Dmod Sources]

This selects a modulation source to control the wah frequency. The default is JS+Y, but you can also use a real pedal if you have one connected!

**Pedal Manual** [1...100]

This sets the default value of the pedal, before the selected modulation source is moved. Once the source has been moved, **Pedal Manual** has no effect. The default is 84.

**Auto Wah**

These parameters appear only when the **Mode** is set to **Auto Wah**.

**Auto Sensitivity** [0...100]

This sets the sensitivity of auto-wah. Increase the value if the input signal is too low to sweep the wah. Reduce the value if the input signal is so high that the sweep stops temporarily. The default is 18.

**Auto Attack** [1...100]

This controls the reaction time of the auto-wah. The default is 10.

**Auto Polarity** [Up, Down]

This controls whether the auto-wah sweeps from open to closed, or from closed to open. The default is **Up**.

**OUTPUT**

**Wet/Dry**  [Dry, 1:99...99:1, Wet]

Sets the balance between the “wet” processed sound and the dry input. The default is **Wet**.

**Source** [List of Dmod Sources]

Selects a modulation source for **Wet/Dry**.

**Amount** [-100...+100]

Sets the modulation amount for **Wet/Dry**.

## Program P9: AMS Mixers

---

### P9 AMS Mixers

The EP-1's AMS Mixers are identical to those of the AL-1. For detailed explanations, please see "9-1: AMS Mixer," on page 221.

# EP-1: Tone Adjust

EP-1 Tone Adjust Default Settings

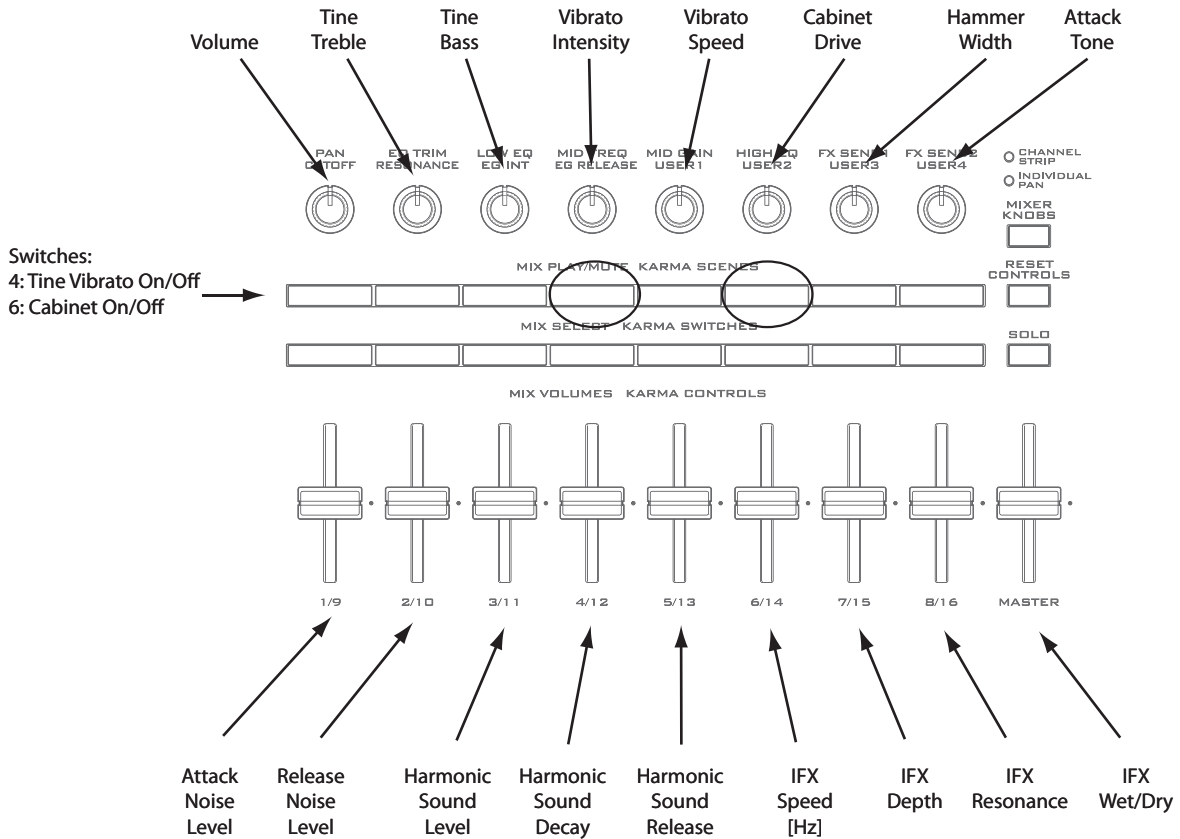

## Common Tone Adjust parameters

The EP-1 supports the following Common Tone Adjust parameters:

**Off.** This means that the Tone Adjust control has no effect.

**Common LFO Speed. (-99...+99, Relative)**

This scales the EXi Program's Common LFO **Frequency**. When the LFO is in MIDI/Tempo mode, this adjusts the **Base Note**.

**Unison. (Off/On, Absolute)**

This **Absolute** parameter turns the EXi Program's **Unison** parameter on and off. For more information, please see "Unison" on page 38.

**Number Of Voices. (2...16, Absolute)**

This **Absolute** parameter sets the number of Unison voices. If **Unison** is not **On**, this parameter has no effect. For more information, please see "Number of voices" on page 38.

**Detune. (0...200, Absolute)**

This **Absolute** parameter sets amount of detuning between the Unison voices. If **Unison** is not **On**, this parameter has no effect. For more information, please see "Detune" on page 38.

**Thickness. (Off/01...09, Absolute)**

This **Absolute** parameter sets the pattern of detuning between the Unison voices. If **Unison** is not **On**, or if **Detune** is set to 0, this parameter has no effect. For more information, please see "Thickness" on page 39.

**Common Step Sequencer Attack Smoothing. (00...99, Absolute)**

This **Absolute** parameter sets amount of attack smoothing for the Common Step Sequencer. For more information, please see "Smoothing" on page 178.

**Common Step Sequencer Decay Smoothing. (00...99, Absolute)**

This **Absolute** parameter sets amount of decay smoothing for the Common Step Sequencer. For more information, please see "Smoothing" on page 178.

## EP-1 Tone Adjust parameters

In addition to the Common Tone Adjust parameters listed above, the EP-1 adds a number of its own parameters.

Note that these additional parameters are separate for each EXi, as opposed to being shared by both EXi in the Program.

All of the EP-1 Tone Adjust parameters are of the **Absolute** type, which directly correspond to the main parameter values.

The full name of the currently selected parameter is shown in the status line at the top of the Control Surface page, as well as in the popup menu. Some parameters with longer names may show an abbreviation for the slider, knob, and switch labels.

**Oscillator**

Harmonic Sound Level  
Harmonic Sound Decay  
Harmonic Sound Release  
Attack Noise Level  
Release Noise Level  
Attack Tone  
Hammer Width

**Panel**

Volume  
Tine Treble  
Tine Bass  
Tine Vibrato On/Off  
Vibrato Speed  
Vibrato Intensity  
Cabinet On/Off  
Cabinet Drive

**Insert Effects**

IFX Speed [Hz]  
IFX Depth  
IFX Resonance  
IFX Attack  
IFX Wet/Dry

# Combination mode

## Combination P0: Play

This is the main page of Combination mode. Among other things, you can:

- Select combinations
- Edit KARMA in simple ways
- Make audio input and resampling settings for use in Combination mode
- Use the control surface

### Auto Song Setup

This feature copies the current Program or Combination into a Song, and then puts the KRONOS in record-ready mode.

If inspiration for a phrase or song strikes you while you're playing, you can use this function to start recording immediately. To do so:

1. Hold down the ENTER key and press the SEQUENCER REC/WRITE key.

The Setup to Record dialog box will open and ask "Are you sure?"

2. Press OK.

You will automatically enter Sequencer mode, and will be in the record-ready state.

3. Press the START/STOP key to start the sequencer and begin recording.

## 0-1: Program Select/Mixer

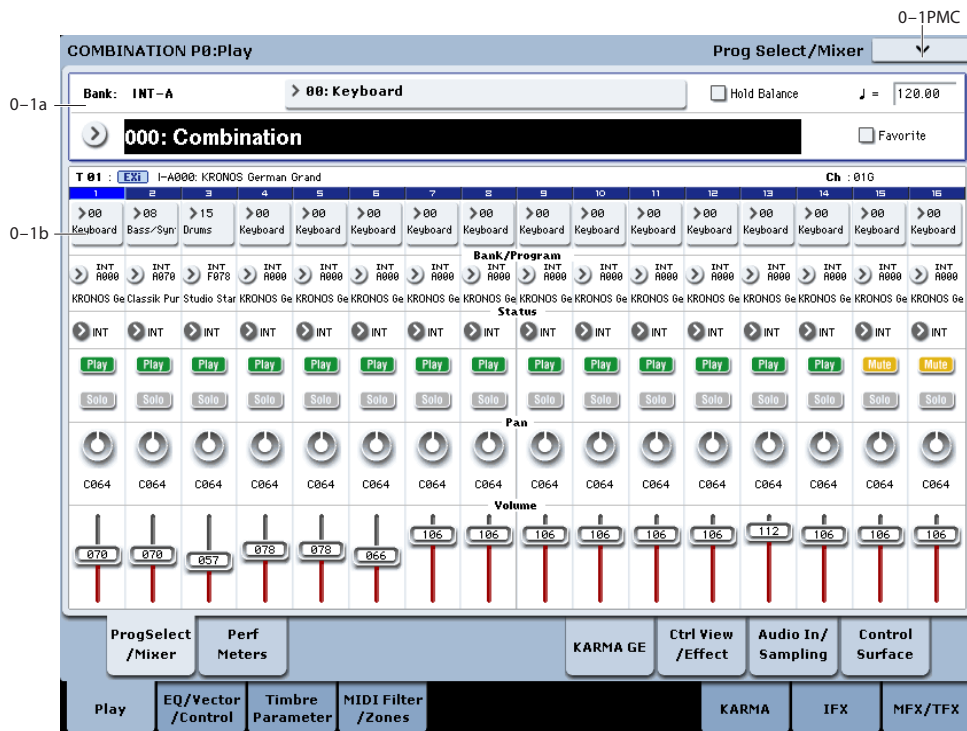

This is the main page for selecting and playing Combinations. You can also set the Program, status, pan, and volume for each of the 16 Timbres.

*Tip:* Wherever you are in the Combination mode pages, pressing EXIT three times (or fewer) will take you back to this page, and select the Combination name. You can then immediately use the numeric keys or  $\triangle$  /  $\nabla$  switches to select a different Combination.

For instance, if you're on any page other than P0: Play:

- Press it once to go to the previously-selected tab on the main P0 page, such as Control Surface or Prog Select/Mixer.
- Press it again to go to the first tab on the main P0 page—the main Combination Play page. If you had

previously selected a parameter on this page, that parameter will be selected.

- Press it a third time to select the main Combination name parameter.

### 0-1a: Combination Select

**Bank** [INT-A...G, USER-A...G]

This indicates the currently selected combination bank.

Press one of the BANK SELECT INT A – USER G switches to select the desired bank.

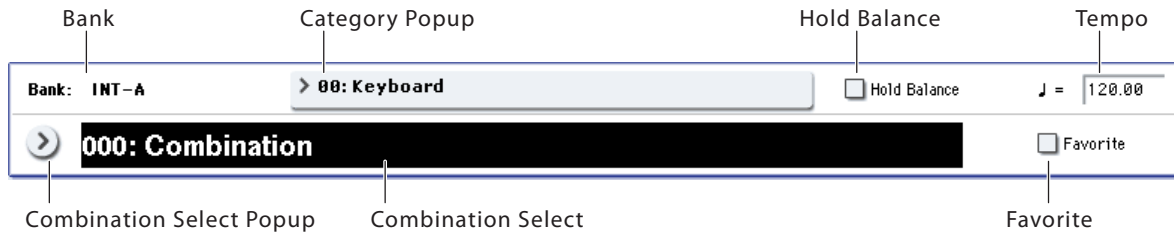

Each bank contains rewritable areas for 128 Combinations (a total of 1,792).

Bank	No.	Description
INT-A...C	000...127	Preloaded combinations
INT-D	000...095	
INT-D	096...127	User combinations
INT-E...G, USER-A...G	000...127	

*Note:* Pressing one of the BANK SELECT INT A–USER G switches while the **Program Select** parameter is selected in this page will change the timbre program bank (rather than the combination bank).

### Combination Select [000...127]

Here you can select the desired Combination.

#### To switch combinations

- Choose “Combination Select,” use numeric keys 0–9 to input the desired combination number, and press the ENTER switch.

- Choose “Combination Select” and turn the VALUE dial or use the  $\Delta/\nabla$  switches.

*Note:* On this page only, the VALUE slider functions as a modulation source - which means that you can’t use it to select combinations.

- If the “0–1a: Combination Select” parameter is selected, the BANK SELECT INT A–USER G switches will switch combination banks.
- From the Bank/Combination Select menu you can view and select combinations by bank.
- From the Category/Combination Select menu you can view and select combinations by category.
- In the Bank/Combination Select menu or Category/Combination Select menu, you can use the Favorite function to view and select combinations whose “Favorite” setting is on.
- You can use a foot switch to select combinations. For more information, see the Global parameter “Foot Switch Assign” on page 781. For a list of the functions that can be assigned to the footswitch, see “Foot Switch Assignments” on page 1106.
- You can transmit MIDI program changes from a connected external MIDI device.

#### Bank/Combination Select menu

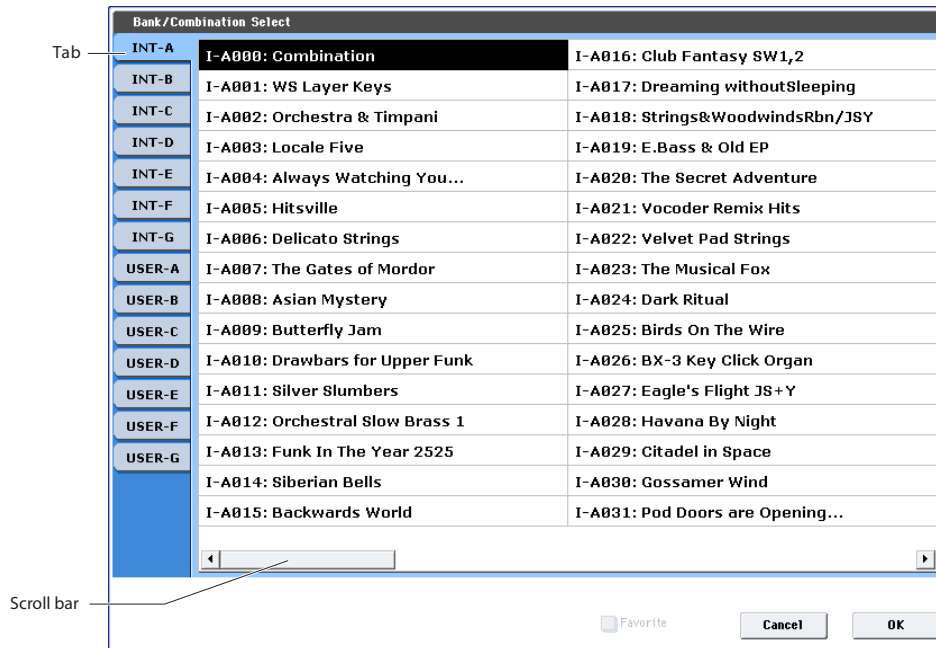

#### Bank/Combination Select

- Press the popup button located at the left of “Combination Select” to access the Bank/Combination Select menu.
- Press one of the tabs at left to select a bank.

- Select a combination from the list. You can directly press your choice within the list, or use the  $\Delta/\nabla$  switches.

If the screen cannot display all of the available items, use the scroll bar.

Category/Combination Select menu

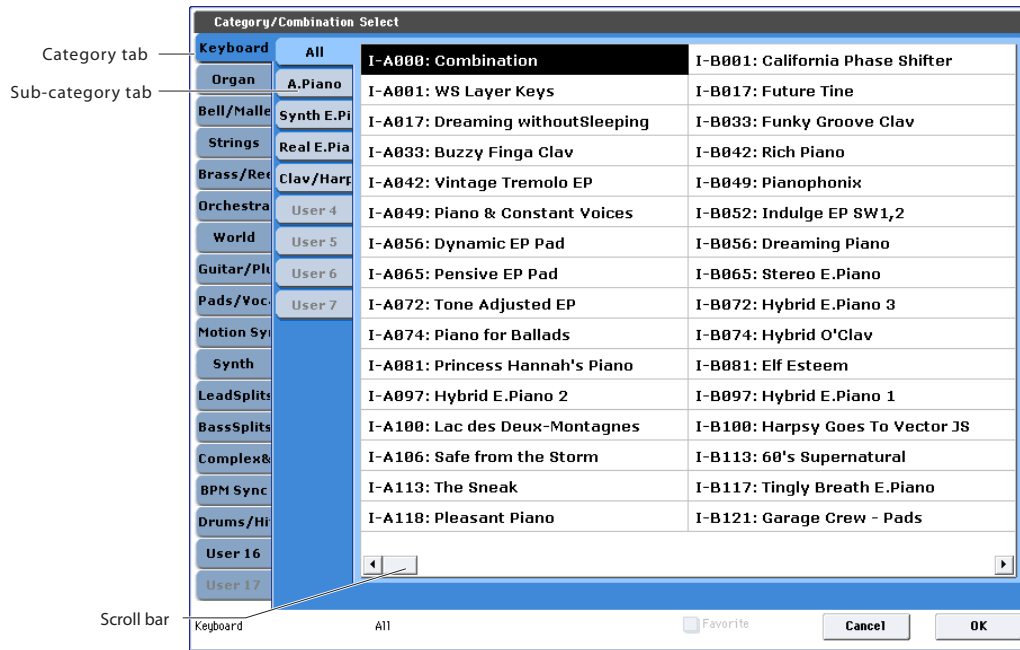

- If you enable the Favorite check-box, the combinations marked as Favorites will be shown. If the selected bank contains no combinations for which Favorite is turned on, this cannot be chosen.
- Press the OK button to execute, or press the Cancel button to cancel your selection.

- Press the OK button to execute, or press the Cancel button to cancel your selection.

Note: The category of each combination can be specified in the "Write Combination" dialog box.

### Category/Combination Select

You can select combinations by category and sub-category. All combinations are organized into up to eighteen categories, and each category is further organized into eight sub-categories. You can use these categories and sub-categories to select combinations.

- Press "Category/Combination Select" to display the menu.
- Press a tab in the left-most column to select a category. You cannot choose a category tab to which no combinations have been assigned.
- Press a tab in the second from left column to select a sub-category.

**All:** All combinations in the category will be shown. Choose this when you don't need to use sub-categories.

**0...7:** The combinations will be shown by sub-category.

You cannot select the tab of a sub-category to which no combinations have been assigned.

Select a combination from the list. You can directly press your choice within the list, or use the  $\Delta/\nabla$  switches.

If there are more combinations than can be shown in the screen, use the scroll bar to see the remaining combinations.

- If you check "Favorite" in the menu, the combinations you marked as Favorites will be shown.

You cannot select this if no combinations in the selected category are marked as Favorites.

### Favorite [Off, On]

**On (checked):** Turns on the Favorite setting for combinations. Only combinations that you marked as favorites will be shown and can be selected in the Bank/Combination Select menu and Category/Combination Select menu. If you mark frequently-used combinations as Favorites (i.e., check the Favorite setting for those combinations), it will be easy to find them later.

Note that you must write the Combination in order to save changes to this setting.

### Tempo [040.00...300.00, EXT]

This is the tempo for the current Combination, which applies to tempo-synced LFOs and Wave Sequences, the Vector EG, EXi Step Sequencers, KARMA, and tempo-synced effects.

**EXT** means that the tempo will sync to external MIDI clocks. You'll see this if the Global MIDI page **MIDI Clock** parameter is set to **External MIDI**, or if it's set to **Auto** and the KRONOS is currently receiving MIDI clocks. For more information, please see "MIDI Clock (MIDI Clock Source)" on page 772.

**040.00...300.00** allow you to set a specific tempo in BPM, with 1/100 BPM accuracy. In addition to using the standard data entry controls, you can also just turn the TEMPO knob, or by playing a few quarter-notes on the TAP TEMPO button.

### Hold Balance [Off, On]

**On (checked):** When any one of the volume sliders is moved, the volume of the other timbres will change as well. The volume balance of timbres 1-16 will be maintained. This is useful when you wish to adjust the overall volume.



## 0-1b: Timbre Program Select

### Selected Timbre Info

This area shows information on the timbre selected for editing. T: Timbre number/program bank/number/name, Ch: MIDI channel/number.

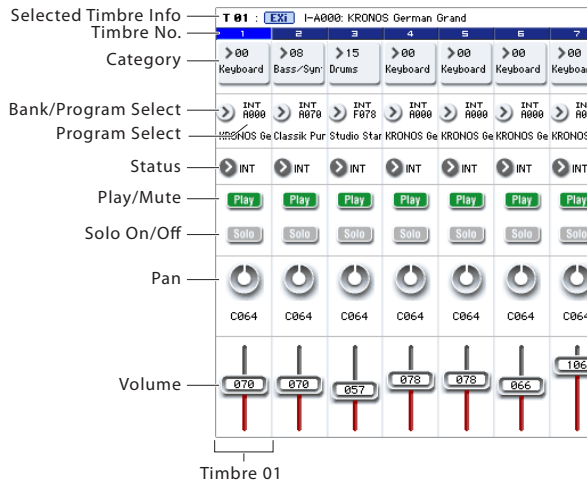

### Gray color and [Inactive] warning in Timbre Info

Normally, the numbers for un-selected Timbres use a dark blue background, and a light blue background highlights the selected Timbre.

If the background is gray, instead, this means that the maximum amount of EXi Fixed Resources has been exceeded, and the EXi Program assigned to the Timbre will be muted and inactive. In this case, the Selected Timbre Info will also show the warning [Inactive] after the Program's name.

For more information on this subject, including ways to get more out of the system, see "CX-3 & other EXi: Limitations on EXi fixed resources" on page 420.

### Red color and "Samples Not Loaded" message

If the Timbre's Program uses one or more EXs Multisamples, Samples, or Drum Samples which are not currently loaded, it will not sound correctly. As an indication of this, the Timbre number's background turns red, and the message "Samples Not Loaded" will appear at the top of the display. To fix this, load the required EXs sample data.

### Timbre 01 (Timbre Number)

This indicates the timbre number. Below each timbre number are shown various parameters which you can edit for that timbre.

### Category (Timbre Program) [00...17]

Here you can select the program used by each timbre by program category and sub-category. All programs are organized into up to eighteen categories and eight sub-categories.

Press this popup button to get the Category/Program Select menu, then select the desired category and sub-category, and finally select the desired program.

### Category/Program Select

1. Press "Category" to get the Category/Program Select menu.
2. Press a tab in the left-most column to select a category. You can't select the tab for a category if no programs are assigned to that category.
3. Press a tab in the second from left column to select a sub-category.

All: All programs in the category will be shown. Choose this if you don't need to see sub-categories.

0...7: The programs will be shown by sub-category. You can't select the tab for a sub-category if no programs are assigned to that sub-category.

Select the desired program from the list. You can directly press a program in the list, or use the  $\Delta/\nabla$  switches.

If there are more programs than can be shown in the screen, use the scroll bar to see the remaining programs.

4. If you check "Favorite" in the menu, the programs you marked as Favorites will be shown. You cannot select this if no programs in the selected category are marked as Favorites.
5. Press the OK button to execute, or press the Cancel button to cancel your selection.

### Program Select [0...127 (INT and USER Banks), 1...128 (GM Banks)]

Here you can select the program used by each timbre. The lower line displays part of the program name.

### To switch the program of a timbre

- Choose **Program Select**, use numeric keys 0-9 to input the program number, and press the ENTER switch.
- Choose **Program Select** and turn the VALUE dial or use the  $\Delta/\nabla$  switches.
- If the **Program Select** parameter is selected, the BANK I-A-U-G switches will switch program banks. (If Timbre Program Select is selected, the BANK switch LED of the program bank selected for that timbre will light.)
- From the Bank/Program Select menu you can view and select programs by bank.
- From the Category/Program Select menu you can view and select programs by category.
- In the Bank/Combination Select menu or Category/Program Select menu, you can use the Favorite function to view and select programs whose "Favorite" setting is check.
- You can transmit MIDI program changes from a connected external MIDI device.

**MIDI** When you select a Combination on the KRONOS, a MIDI program change for the selected combination number will be transmitted on the global **MIDI Channel** (Global 1-1a). At the same time, bank select, program change, and volume (CC#7) messages will be transmitted on the MIDI channel specified for each timbre whose **Status** (0-1b, 2-1a) is set to EXT or EX2. However, these messages will not be transmitted for timbres that are set to the

same MIDI channel as the global MIDI channel. In this case, EX2 timbres will show the “Program” Bank as “–”, and will transmit the bank number that was specified in “Bank Select” (2-1a).

When you play on the KRONOS keyboard and controllers, MIDI messages are transmitted on the global **MIDI channel**. At the same time, timbres whose **Status** is set to EXT or EX2 will transmit the same messages on their own MIDI channel.

If bank select and program change messages are received on a MIDI channel that matches the MIDI channel of a timbre whose **Status** is INT, the program of that timbre will change. However if the MIDI channel of the incoming message matches the global MIDI channel “MIDI Channel,” then the combination will change.

If you do not want the combination to change, you can either change the global MIDI channel so that it does not match the channel on which the program change messages are being received, or you can uncheck “Combination Change” (Global 1-1c). You can also uncheck “Bank Change” so that only the program number will change and the bank will remain the same.

If you wish to change the program assigned to certain timbres without changing the combination, you can also set **Enable Program Change** (3-1a) so that the program will change on certain timbres but not on others.

**Bank/Program Select**

1. Press the popup button at the left of Program Select to get the Bank/Program Select menu.
2. Press the left tab to select a bank.
3. Choose the desired program from the list. You can directly press a program in the list, or use the  $\Delta/\nabla$  switches.

If there are more programs than can be shown in the screen, use the scroll buttons to see the remaining programs.

4. If you check “Favorite,” only the programs you marked as Favorites will be shown.  
You cannot select this if no programs in the selected bank are marked as Favorites.
5. Press the OK button to execute, or press the Cancel button to cancel your selection.

**Status** [Off, INT, EXT, EX2]

This sets whether the Timbre controls the internal sounds, or external MIDI devices.

When controlling external MIDI devices, it also allows you to choose between using the internal Bank Select numbers (as set by the front-panel buttons), or using custom Bank Select settings to match the external device.

**Off:** Use this to disable the Timbre. With this setting, the Timbre’s Program will not sound, and MIDI data will not be transmitted. Also, any EXi fixed resources used by the Program will be freed.

**INT:** Use this to make the Timbre play internal sounds. With this setting, the Timbre’s Program will respond to both the local keyboard and MIDI input on the Timbre’s MIDI channel. The Timbre will not transmit MIDI data.

**EXT:** Use this to play an external MIDI device, with Bank Select via the front-panel Bank buttons. With this setting, the Timbre’s Program will not respond to either the local keyboard or MIDI input. MIDI will be transmitted to external devices on the selected MIDI channel.

**EX2:** Use this to play an external MIDI device, with custom-set Bank Select via the **Bank Select LSB** and **MSB** parameters, on the **MIDI** tab of the **Timbre Parameters** page. In all other ways, this is the same as **EXT**.

For more information, see “Bank Select MSB (When Status = EX2)” on page 454.

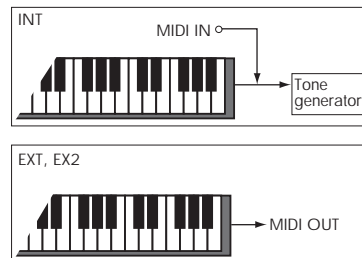

**Using the control surface to make timbre settings**

You can use the control surface to edit the mix parameters for each Timbre, including PLAY/MUTE, Solo On/Off, Pan, Volume, FX sends, and EQ. These can also be controlled from the mixer section of the front panel, or from the P0- Control Surface page of the LCD screen.

For more information, see “Adjusting the mix” on page 60 of the Operation Guide.

**Play/Mute** [Mute, Play]

This determines whether or not the Timbre will sound. The setting will alternate each time you press the Play/Mute button.

**Mute:** The timbre will not sound.

**Play:** The timbre will sound.

*Tip:* You can use the control surface to control this parameter. For more information, see “Using the control surface to make timbre settings” on page 419.

**Solo On/Off** [On, Off]

This setting switches the Solo function on/off.

Only timbres that are set to Solo On will be heard. Other timbres (and audio inputs: 0-8a) will be muted.

The setting will alternate each time you press the Solo button.

**MIDI** Timbres that have been silenced by the Mute or Solo functions will not transmit note-on/off messages on the MIDI channel assigned for their track when the timbre’s **Status** (2-1a) is BTH, EXT, or EX2.

The Solo function operates differently depending on the setting of the **Exclusive Solo** page menu command. If Exclusive Solo is off, you can turn Solo on for more than one timbre.

If Exclusive Solo is on, pressing a Solo button will turn Solo on for only that timbre.

 **Solo** settings are not preserved when you write a combination.

*Tip:* You can use the control surface to control this parameter. (“Using the control surface to make timbre settings” on page 419)

**Pan** [RND, L001...C064...R127]

This specifies the pan of each timbre.

**L001...C064...R127:** A setting of L001 is far left and R127 is far right. A setting of C064 will reproduce the pan setting of the Program mode.

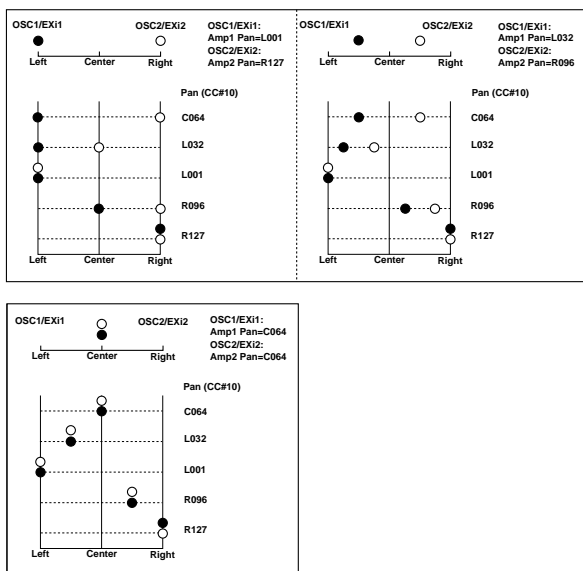

If a mono insert effect is in use, the settings you make here will be ignored. In this case, the “Pan (CC#8)” parameter in P8– Insert FX page will adjust the panning of the sound after the insert effect (“Mixer” on page 874).

**RND:** The oscillator pan will change randomly at each note-on.

*Tip:* You can use the control surface to control this parameter. For more information, see “Using the control surface to make timbre settings” on page 419.

 If **Status** (2–1a) is set to INT, CC#10 (pan) messages can be received to control the setting. CC#10 values of 0 or 1 will place the sound at far left, 64 at center, and 127 at far right. (exclude RND) Pan can be controlled by messages received on the **MIDI Channel** (2–1a).

**Volume** [000...127]

Adjusts the volume of each timbre 1–16.

*Tip:* You can use the control surface to control this parameter. For more information, see “Using the control surface to make timbre settings” on page 419.

 The volume of each timbre is determined by multiplying this volume value with the MIDI volume (CC#7) and expression (CC#11).

If **Status** (0–1b, 2–1a) has been set to INT, incoming MIDI CC#7 or CC#11 messages will control the volume of a timbre. (However these messages will not affect the setting of this parameter.)

If **Status** is EXT or EX2, the value of this parameter will be transmitted as MIDI CC#7 when the combination is changed. However this will not be transmitted by a timbre that is set to the same MIDI channel as the global MIDI channel. This message is transmitted on the **MIDI Channel** (2–1a) specified for each timbre.

**Timbre 02...16 (Timbre Number)**

Here you can specify the program etc. for each Timbre 2 through 16. These settings are the same as for Timbre 1, as described above.

**CX-3 & other EXi: Limitations on EXi fixed resources**

**Dynamic resources and fixed resources**

KRONOS processing power is shared between synthesizer voices and effects.

Synthesizer voices typically use *dynamic* resource allocation, so that they primarily use processing power when notes are being played. Effects, on the other hand, use *fixed* allocation; once you call up an effect in an IFX, MFX, or TFX slot, it always uses processing power, whether or not any audio is passing through it.

Many of the EXi also include effects or other fixed components, which take up a small amount of processing power even when voices are not being played. We call these “EXi fixed resources.”

**EXi with fixed resources**

The HD-1 and AL-1 are completely dynamic. All other EXi use some amount of fixed resources.

The CX-3 uses the most, incorporating substantial fixed elements—such as the built-in rotary speaker, amp, and vibrato chorus—along with dynamically allocated individual voices. The fixed elements take up a reasonable amount of processing power, while each additional voice uses only a small amount more.

The EP-1 also uses a moderate amount of processing power for its amp and effects. The remaining EXi all use a much smaller amount of fixed resources, for features such as built-in effects or audio inputs.

**Performance Meters**

The Performance Meter page gives an overview of the system resource usage, including the current amount of EXi fixed resources. For more information, see “0–2: Performance Meters” on page 421.

**Limits on usage of fixed resources**

When you load an EXi which uses fixed resources, the fixed elements start using processing power immediately. To leave room for dynamic voices, the KRONOS limits EXi fixed resources to a maximum of 50% of the voice processing power. Individual Programs can’t exceed this amount, but it’s possible to hit the limit when using many CX-3 or EP-1 Programs in a Combination or Song.

For instance, you can use up to eight CX-3s simultaneously, or eighteen EP-1s, or a combination of the two (e.g., four CX-3s and nine EP-1s). The other EXi have no practical limitation by themselves, but if you're using a lot of CX-3 or EP-1 Programs you may run into situations in which the less-resource-intensive EXi would push the resource usage over the top.

Each EXi in each Program counts towards the maximum. For instance, a Program which uses two CX-3s counts as two, not as one.

Note that depending on the specific combination of EXi in use, you may not be able to fit in more EXi Programs (especially those using the CX-3 or EP-1) even if the Performance Meter page shows EXi fixed resources at somewhat below 50%.

### Gray Timbre/Track number, and [Inactive] shown after Program name

If you try to load a Program which would exceed the maximum amount of EXi fixed resources, the newly added Program will not sound.

To let you know that this has happened, the bar containing the Timbre/Track number (at the top of the mixer channel) will turn gray, and the Selected Timbre/Track Info will show the warning [Inactive] after the Program name.

You can re-enable an inactive Program by removing or disabling other Programs which use EXi fixed resources. For instance:

1. **Select an initialized Combination ("Init Combi").**
2. **Load Program I-B000 HD-1 Piano-Damper into all of the Timbres.**
3. **Load Program INT-A 040 Felix'sDaKat into Timbres 1 through 8.**

This Program uses a single CX-3, so loading it into eight separate Timbres uses up all of the available EXi fixed resources.

4. **Load the same Program into Timbre 9.**

Since there are no remaining EXi fixed resources, the Timbre number will turn gray, and the Program won't make any sound. Let's fix that:

5. **Set Timbre 1's Status to Off**

or

**Change Timbre 1 to use an HD-1 or AL-1 Program (such as INT-B 000), instead of a CX-3.**

This frees up the EXi fixed resources formerly used by Timbre 1; Timbre 9 will then return to its normal color, and its Program will make sound again.

These same steps will work with Tracks in Sequencer mode.

### Use Program Changes to optimize resource usage

If you're using KRONOS for multitimbral sequencing (with different Programs on different MIDI channels), you can optimize the EXi fixed resource usage by only having these Programs loaded when they are needed.

For instance, if you're playing a CX-3 only during the chorus of a song, you can use Program Change to switch that channel to an HD-1 or AL-1 Program during the verse.

Neither the HD-1 nor the AL-1 uses fixed resources, so this will free up KRONOS computing power. You can then use this power for more voices of other sounds, or for other EXi with fixed resources on different Timbres or Tracks.

---

## ▼ 0–1: Page Menu Commands

The number before each command shows its ENTER + number-key shortcut. For more information on these shortcuts, see "ENTER + 0-9: shortcuts for menu commands" on page 147.

- **0: Write Combination.** For more information, see "Write Combination" on page 501.
- **1: Exclusive Solo.** For more information, see "Exclusive Solo" on page 147.
- **2: Copy From Program.** For more information, see "Copy From Program" on page 501.
- **3: Add to Set List.** For more information, see "Add To Set List" on page 148.

---

## 0–2: Performance Meters

This page lets you look at the real-time performance of the KRONOS, including voice usage, voice stealing, and effects.

For more information, see "0–2: Performance Meters" on page 7.

## 0-6: KARMA GE

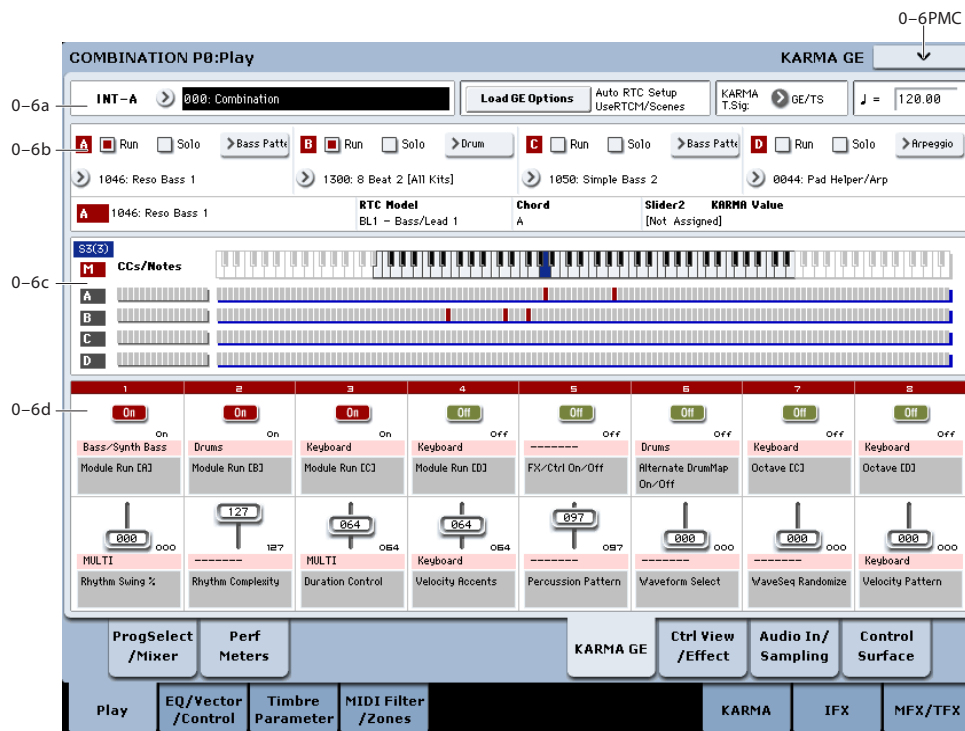

This page gives you an overview of the four KARMA Modules (A-D), and lets you make basic adjustments. For more detailed editing of KARMA parameters, see “Combination P7: KARMA” on page 470.

The settings of the KARMA ON/OFF and LATCH switches, KARMA SCENES 1-8 switches, KARMA SLIDERS 1-8, and KARMA SWITCHES 1-8 are saved independently for each Combination.

### 0-6a: Combination Select, Load GE Options, KARMA T.Sig, Tempo

**Bank** [INT-A...G, USER-A...G]

**Combination** [0...127]

These are the bank, number, and name of the current Combination. For more information, see “0-1a: Combination Select” on page 415.

**Load GE Options** [Dialogue]

For more information, see “Load GE Options” on page 9.

**KARMA T.Sig (KARMA Time Signature)**  
[GE/TS, 1/4...16/4, 1/8...16/8, 1/16...16/16]

Please see “KARMA T.Sig (Time Signature)” on page 10.

**♩ (Tempo)** [040.00...300.00, EXT]

This is the tempo for the current Combination, which applies to tempo-synced LFOs, Wave Sequences, and Vector EGs, EXi Step Sequencers, KARMA, and tempo-synced effects.

**EXT** means that the tempo will sync to external MIDI clocks. For more information, see “Tempo” on page 417.

040.00...300.00 allow you to set a specific tempo in BPM, with 1/100 BPM accuracy.

### 0-6b: GE Select

The phrases and patterns produced by a KARMA Module are generated by a **GE (Generated Effect)**. Based on input note data from the keyboard, the GE creates phrases and patterns using numerous internal parameter settings to control the development of the note data, the rhythm, the chord structure, the velocity etc. MIDI control changes and pitch bend etc. can also be generated in synchronization with the phrase or pattern. In this way you can produce phrases and patterns in which the GE freely varies the tone or pitch.

#### A (Module A)

**Run** [Off, On]

Turns on the selected Module(s). When off, the Module(s) may still be playing, but they are muted. In this case, turning Run on allows the Module to resume playback from its present location. The Run settings are stored with the combination.

**Solo** [Off, On]

Solos the selected Module(s), even if their Run button(s) are Off (unchecked). This setting will be cleared when you reselect the combination.

It will not be remembered when you write the combination.



**GE Select** [Preset 0000...2047, USER-A...L 000...127]

This selects the GE for the KARMA module. There are a total of 3,584 to choose from: 2,048 preset GEs, and 1,536 rewritable User GEs (12 banks of 128 each).

Preset GEs are part of the system software.

User GEs may be included with new banks of sounds, and can also be created using KARMA KRONOS software (dedicated software for the KRONOS\*). For more information on loading User GEs, see "Load .KGE" on page 843.

\* Made by Karma Lab (<http://www.karma-lab.com>). Macintosh and Windows are supported. English version only.

**GE Bank Select** [Preset...USER-L]

This selects the GE bank. The Preset bank is part of the system software; User banks can be loaded from disk. For more information, see "GE Select," above.

**GE Category Select** [Arpeggio...Real-Time]

This lets you select a GE by category, from **Arpeggio** through **Real-Time**.

**B, C, D (Module B, C, D)**

Here you can make settings for Modules B through D. These settings are the same as for Module A. See "A (Module A)."

**Selected KARMA Module Info**

This displays information for the KARMA Module specified by the Module Control Setting.

**GE Number & Name** [A:0000(PRE):24 characters]

This displays the GE number and full GE name for the specified KARMA Module. If you select the "GE Select" parameter (see "GE Select" on page 423) for another Module, it will display the GE number & name for that Module, until the Module Control Setting is changed.

**RTC Model** [List of RTC Models]

This shows the GE's RTC Model, as specified internally for each preset GE.

RTC stands for "Real Time Control." RTC models provide a level of standardization for controlling the over 200 internal parameters of a GE. For more information, see "Load GE Options" on page 9.

**Chord** [Chord name]

This shows the name of the chord detected for the KARMA Module specified by the Module Control setting. If "M" Master is selected, the chord for the last of the Modules in operation will be displayed. (In other words, if Modules A, B and C are running, the chord for Module C will be displayed.)

*Note:* Chord detection is affected by the key zone (Combination 7-1b) and "Transpose" (Combination 7-3b: Module Parameter-Control) of each KARMA Module, and by the "Dynamic MIDI Destination" (Combination 7-8) "Chord Scan" and "Smart Scan" settings.

**KARMA Value**

When you move or press a KARMA SLIDER or SWITCH, this area shows the number and value of the GE Real-Time Parameters or Perf Real-Time Parameters assigned to the control. This lets you see which parameters are being controlled by the slider or switch, and how.

*Display example*

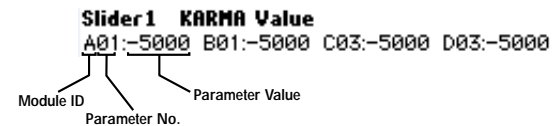

**Module ID** [A, B, C, D, P]

This shows the type of parameter assigned to the slider or switch, and the module to which it belongs.

**A, B, C, D:** The control is assigned to a GE Real-Time Parameter from the indicated KARMA Module.

**P:** The control is assigned to a Perf Real-Time Parameter.

**Parameter No.** [01...32]

When **Module ID** is **A, B, C,** or **D,** this shows the number of the assigned GE Real-Time Parameter (01...32). These parameters are assigned to controls on the 7-5: GE Real-Time Parameters page.

If **Module ID** is **P,** this shows the number of the assigned Perf Real-Time Parameter (01...08). These parameters are assigned to controls on the 7-6: Perf Real-Time Parameters page.

**Parameter Value**

This area shows the current value of the GE Real-Time Parameter or Perf Real-Time Parameter. This will change as you move the slider or operate the switch.

▲ A slider or switch can have multiple parameters assigned to it. A maximum of five assigned parameters can be displayed here in the available space. They will still function when the control is activated, but you cannot view their values directly.

**0-6c: Note/CC Activity**

**S (Scene)** [1...8]

The blue square in the upper left of the section shows the current scene of the selected KARMA module.

The number in parentheses is the default Scene, as stored in the Combination.

**Module** [M, A...D]

These labels identify the CC and note information shown to their right.

They also work as module select buttons, duplicating function of the front-panel MODULE CONTROL button. To select a module, just touch its label; the selected module is shown in red.

## Module CCs/Notes and Scan Zones

### CCs/Notes A...D

These are real-time displays of the notes and/or CC messages generated by each of the KARMA Modules.

### Scan Zone

The key zone settings of the KARMA Modules are displayed as solid blue lines under the notes display.

For more information, see “Bottom (Key Zone Bottom)” on page 471.

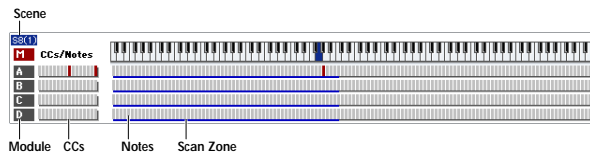

## 0–6d: Realtime Controls

This displays the values, names, and stored settings of KARMA SLIDERS 1–8 and KARMA SWITCHES 1–8. Note that each Scene can have separate values and stored settings for each of the sliders and switches.

### KARMA SWITCHES 1...8

#### Current Value 1...8

This shows the current setting of the KARMA SWITCH. You can control this either by using the physical front-panel switch, or by touching the on-screen switch.

#### Stored Value 1...8

This shows stored value of the KARMA SWITCH for the current Scene, as written into the Combination.

#### Control Timbre Category 1...8

This shows the category of the Program(s) being played by the switch’s KARMA module. For instance, if the KARMA module is playing a drum pattern, this would show **Drums**.

If the module is playing multiple Programs of different categories, this will show **Multi**.

#### Name 1...8

This shows the name of the KARMA SWITCH. You can assign this name in Program 7–9: Name/Map.

### KARMA SLIDERS 1...8

#### Current Value 1...8

This shows the current setting of the KARMA SLIDER.

You can change this either by using the physical front-panel slider, or by touching the on-screen slider and then using any of the data-entry controls.

#### Stored Value 1...8

This shows stored value of the KARMA SLIDER for the current Scene, as written into the Combination.

### Control Timbre Category 1...8

This shows the category of the Program(s) being played by the slider’s KARMA module. For instance, if the KARMA module is playing a drum pattern, this would show **Drums**.

If the module is playing multiple Programs of different categories, this will show **Multi**.

#### Name 1...8

This shows the name of the KARMA SLIDER. You can assign this name in Program 7–9: Name/Map.

## ▼ 0–6: Page Menu Commands

The number before each command shows its ENTER + number-key shortcut. For more information on these shortcuts, see “ENTER + 0-9: shortcuts for menu commands” on page 147.

- 0: **Write Combination**. For more information, see “Write Combination” on page 501.
- 1: **Exclusive Solo**. For more information, see “Exclusive Solo” on page 147.
- 2: **Copy From Program**. For more information, see “Copy From Program” on page 501.
- 3: **Copy KARMA Module**. For more information, see “Copy KARMA Module” on page 504.
- 4: **Initialize KARMA Module**. For more information, see “Initialize KARMA Module” on page 505.
- 5: **Copy Scene**. For more information, see “Copy Scene” on page 157.
- 6: **Swap Scene**. For more information, see “Swap Scene” on page 157.
- 7: **Capture Random Seed**. For more information, see “Capture Random Seed” on page 157.
- 8: **Auto Assign KARMA RTC Name**. For more information, see “Auto Assign KARMA RTC Name” on page 506.
- 9: **Add to Set List**. For more information, see “Add To Set List” on page 148.



## 0-7: Controller View/Effect

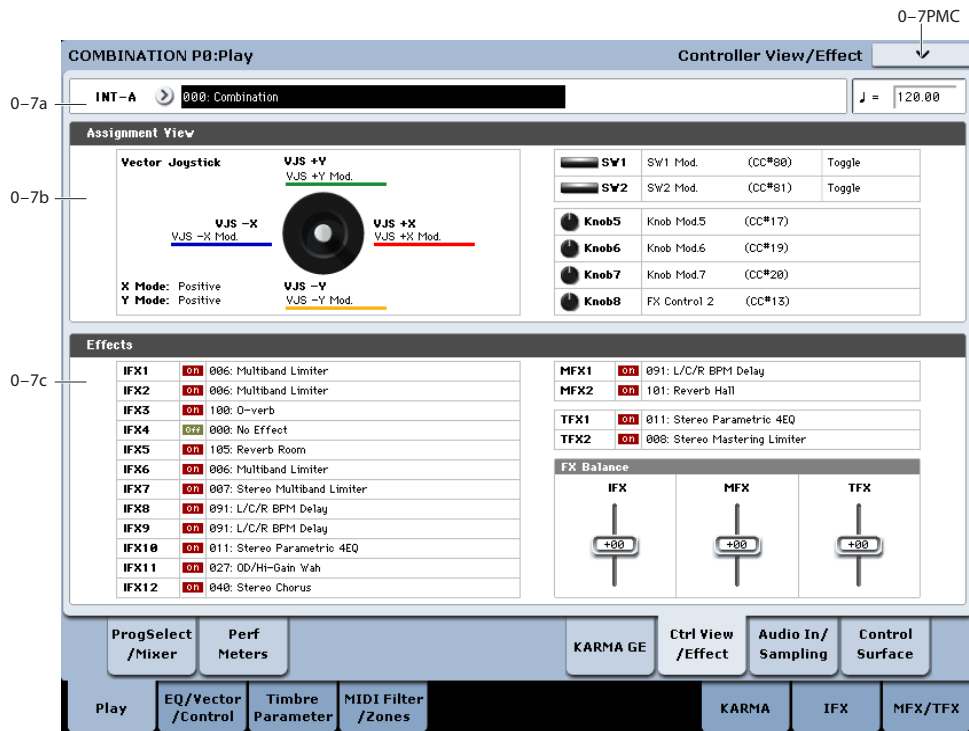

Here you can view the function that is assigned to the vector joystick, SW1 and 2, and knobs 5-8, and view information about the effects. You can also adjust the FX Balance.

### 0-7a: Combination Select

**Bank** [INT-A...G, USER-A...G]

**Combination** [000...127]

These are the bank, number, and name of the current Combination. For more information, see "0-1a: Combination Select" on page 415.

**J(Tempo)** [040.00...300.00, EXT]

This is the tempo for the current Combination, which applies to tempo-synced LFOs, Wave Sequences, and Vector EGs, EXi Step Sequencers, KARMA, and tempo-synced effects.

**EXT** means that the tempo will sync to external MIDI clocks. For more information, see "Tempo" on page 417.

040.00...300.00 allow you to set a specific tempo in BPM, with 1/100 BPM accuracy.

### 0-7b: Assignment View

#### VJS

This area shows information about the vector joystick.

**X Mode, Y Mode:** These indicate the behavior of the vector CC for the X-axis and Y-axis.

**VJS +X, VJS -X, VJS +Y, VJS -Y:** These indicate the controller transmitted by the +X, -X, +Y, and -Y vectors.  
(See "1-6a: Vector CC Control" on page 446)

#### SW1, SW2, Knob5...8

**SW1, SW2:** These indicate the functions assigned to SW1 and 2.

**Knob5...8:** These indicate the functions assigned to knobs 5-8. For more information, see "1-8: Set Up Controllers" on page 451.

### 0-7c: Effects

**IFX1...12, MFX1, 2, TFX1, 2:** This area indicates the effect assigned to each insert effect, master effect, and total effect, and its on/off status.

#### FX Balance

**IFX:** This controls the "Wet/Dry" balance of all insert effects. A setting of +10 is Wet or -Wet, a setting of +0 leaves the settings of the combination unmodified, and a setting of -10 is Dry.

**MFX:** This controls the MFX1 and 2 "Return." A setting of +10 is 127, a setting of +0 leaves the settings of the combination unmodified, and a setting of -10 is 000.

**TFX:** This controls the "Wet/Dry" balance of TFX1 and 2. A setting of +10 is Wet or -Wet, a setting of +0 leaves the settings of the combination unmodified, and a setting of -10 is Dry.

 When you edit these settings, the change will occur immediately in the sound, but the values of the original combination parameters will not change

until you save the combination. When you save the combination, the values will be updated and these sliders will be reset to 0.

▼ 0-7: Page Menu Commands

The number before each command shows its ENTER + number-key shortcut. For more information on these shortcuts, see “ENTER + 0-9: shortcuts for menu commands” on page 147.

- 0: **Write Combination.** For more information, see “Write Combination” on page 501.
- 1: **Exclusive Solo.** For more information, see “Exclusive Solo” on page 147.
- 2: **Copy From Program.** For more information, see “Copy From Program” on page 501.
- 3: **Add to Set List.** For more information, see “Add To Set List” on page 148.

0-8: Audio Input/Sampling

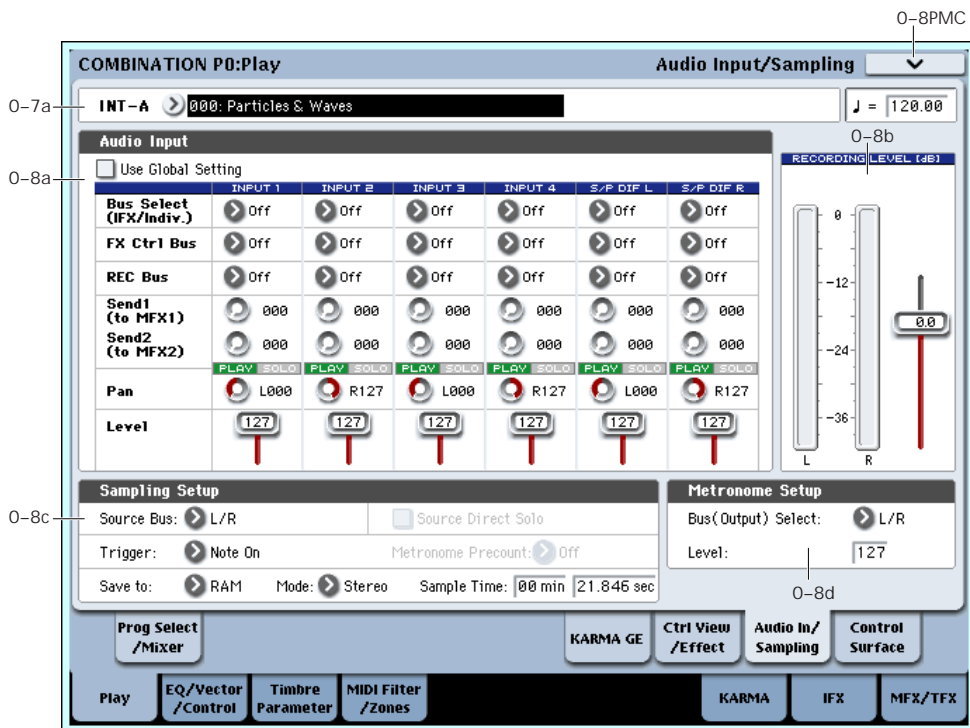

This page lets you adjust the settings for the analog and digital audio inputs, and the sampling-related settings for Combination mode.

You can sample incoming audio signals or resample internal KRONOS sounds, including KARMA and real-time performances. The KRONOS can also be used as a 6-in, 6-out effect processor.

For example, you can:

- Play an guitar through an audio input, while listening to a KARMA phrase—and sample only the guitar input, without any of the KARMA sounds.
- Play a guitar as above, but sample both the guitar and the KARMA phrase together.
- Sample yourself while playing KRONOS sounds in real-time, including controller movements, KARMA, effects, etc.

Using the control surface to adjust Audio Inputs

You can use the control surface to adjust the Audio Input **Send1 (to MFX1)**, **Send2 (to MFX2)**, **PLAY/MUTE**, **Solo On/Off**, **Pan**, and **Level**.

For more information, please see “0-9c: Audio Inputs” on page 25.

⚠ The control surface will control the Global mode settings if “Use Global Setting” is On (checked).

0-8a: Audio Input

These parameters control the level, pan, play/mute and solo status, send levels, and bus assignments for each of the analog and digital inputs. For more information, see “0-8a: Audio Input” on page 14.

Use Global setting [Off, On]

Each Combination can either use the single, Global audio input mixer setup, or have its own custom settings. For more information, see “Use Global setting” on page 14.

### Input1 & 2

These are settings for the analog inputs.

<b>Bus Select (IFX/Indiv.)</b>	[L/R, IFX1...12, 1...4, 1/2...3/4, Off]
<b>FX Ctrl Bus (FX Control Bus)</b>	[Off, 1, 2]
<b>REC Bus</b>	[Off, 1...4, 1/2, 3/4]
<b>Send1 (to MFX1)</b>	[000...127]
<b>Send2 (to MFX2)</b>	[000...127]
<b>PLAY/MUTE</b>	[Off, On]
<b>Solo ON/OFF</b>	[Off, On]
<b>Pan</b>	[L000...C064...R127]
<b>Level</b>	[000...127]

### USB1 & 2

These are settings for the USB inputs. The parameters are the same as for “Input1 & 2” above.

### S/P DIF L & R

These are settings for the S/P DIF digital audio input, for connecting external A/D converters, computer audio systems, DAT machines, or other digital audio gear. The parameters are the same as for “Input1 & 2” above.

KRONOS supports S/P DIF input at 48 kHz.

- When using S/P DIF, make sure that the Global mode’s **System Clock** parameter is set appropriately. For more information, see “System Clock” on page 756.

### 0–8b: Recording Level [dB]

These parameters are the same as in Program mode P0– Audio Input/Sampling. For more information, please see “0–8b: Recording Level [dB]” on page 16.

**Recording Level** [–Inf, –72.0 ... +0.0 ... +18.0]

The **Recording Level** setting applies to all of Combination mode, and is not saved with individual Combis.

### 0–8c: Sampling Setup

Here you can select the source to be sampled, and the method by which to initiate sampling.

<b>Source Bus</b>	[Audio Input1/2, USB 1/2, S/P DIF L/R, L/R, REC1/2...3/4, Indiv.1/2...3/4]
<b>Source Direct Solo</b>	[Off, On]
<b>Trigger</b>	[Sampling START SW, Note On]
<b>Metronome Precount</b>	[Off, 4, 8, 3, 6]

**Save to** [RAM, DISK]

**Mode (Sample Mode)** [L-Mono, R-Mono, Stereo]

**Sample Time** [min sec]

These parameters are the same as in Program mode P0– Audio Input/Sampling. For more information, please see “0–8c: Sampling Setup” on page 17.

The **Sampling Setup** settings apply to all of Combination mode, and are not saved with individual Combinations.

**Sample to Disk** [16-bit, 24-bit]

This sets the bit depth for sampling to disk. For more information, please see “Sample to Disk” on page 20.

### 0–8d: Metronome Setup

Here you can specify the output destination and volume of the metronome sound that is heard when you begin sampling. The metronome is valid only if **Trigger** is set to Sampling START SW.

**Bus (Output) Select** [L/R, L, R, 1...4]

**Level** [000...127]

These parameters are the same as in Program mode. For more information, please see “0–8d: Metronome Setup” on page 427.

### ▼ 0–8: Page Menu Commands

The number before each command shows its ENTER + number-key shortcut. For more information on these shortcuts, see “ENTER + 0-9: shortcuts for menu commands” on page 147.

- 0: **Write Combination.** For more information, see “Write Combination” on page 501.
- 1: **Exclusive Solo.** For more information, see “Exclusive Solo” on page 147.
- 2: **Copy From Program.** For more information, see “Copy From Program” on page 501.
- 3: **Optimize RAM.** For more information, see “Optimize RAM” on page 148.
- 4: **Select Sample No.** This applies only when **Save to** is set to **RAM**. For more information, see “Select Sample No.” on page 149.
- 4: **Select Directory/File for Sample to Disk.** This applies only when **Save to** is set to **Disk**. For more information, see “Select Directory” on page 149.
- 5: **Auto Sampling Setup.** For more information, see “Auto Sampling Setup” on page 150.
- 6: **Add to Set List.** For more information, see “Add To Set List” on page 148.

## 0-9: Control Surface

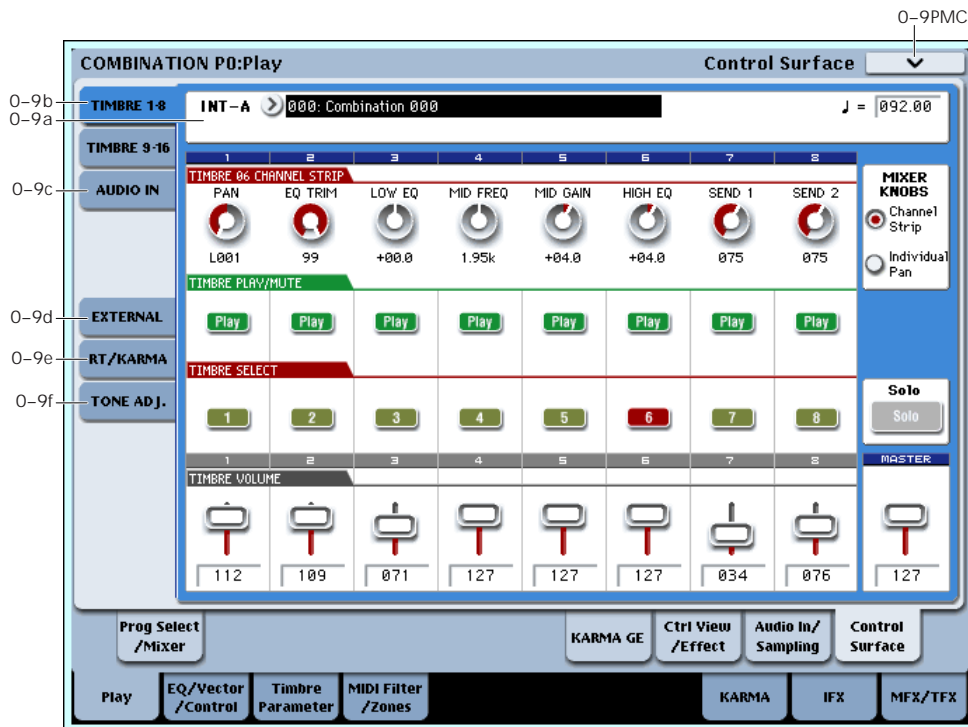

The Control Surface is the set of 9 sliders, 8 knobs, and 16 switches to the left of the LCD display. It looks like a mixer, but it can do other things as well, including editing sounds, controlling KARMA, and sending MIDI messages to external devices.

This page shows you the current values for each of the sliders, knobs, and buttons, along with information about what they are controlling. For instance, you can:

- Adjust the volume and pan for all 16 Timbres
- Control each Timbre’s EQ settings and Master Effects Send levels
- Modulate sounds and effects using the Real Time Knobs
- Control KARMA, and select KARMA scenes, using the sliders and switches
- Edit sounds using Tone Adjust
- Assign sliders, knobs, and switches to different Tone Adjust parameters

For more information about the Control Surface, see:

- “Jump/Catch” on page 22
- “RESET CONTROLS” on page 22

### Local Control On/Off and the Control Surface

The Control Surface generates and receives MIDI CCs and System Exclusive messages, so that you can record knob, switch, and slider movements into a sequencer. This means that the Global mode **Local Control** setting is important:

- If **Local Control** is On, the physical Control Surface will work properly as long as MIDI is **not** being looped back into the KRONOS.

- If **Local Control** is Off, you **must** loop back MIDI into the KRONOS in order for the physical Control Surface to work properly.
- Regardless of the **Local Control** setting, you can always edit Control Surface parameters via the touch-screen.

For more information, see “Local Control and the Control Surface” on page 771.

### Control Assign Switches and Tabs

You can switch the Control Surface between its different functions using either the tabs on the left side of the LCD display, or the front-panel Control Assign switches. The tabs and the front-panel switches mirror one another; when you change one of them, the other changes as well.

In Combi mode, you can select one of five different functions:

**TIMBRE/TRACK** lets you adjust the volume, pan, EQ, and send levels for each of the 16 Timbres, eight at a time. The LEDs to the right of the switch show whether you’re currently editing Timbres 1–8 or 9–16; press the **TIMBRE/TRACK** button to toggle between the two.

If you switch to one of the other Control Assign modes, and then go back to **TIMBRE/TRACK**, it will automatically return to the previously selected group (1–8 or 9–16).

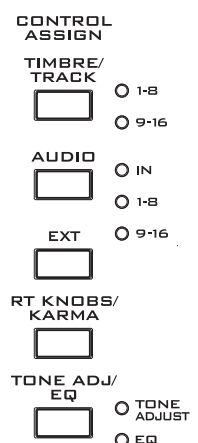

**AUDIO INPUTS** lets you adjust the volume, pan, and send levels for the analog, USB, and S/P DIF audio inputs. In Sequence mode, you can also use this to select two banks of hard-disk recording tracks, as shown by the LEDs to the right of the switch.

**EXTERNAL** lets you send MIDI messages to external MIDI devices.

**R.TIME KNOBS/KARMA** lets you modulate sounds and effects with the knobs, and control KARMA with the sliders and switches.

**TONE ADJ./EQ** lets you edit Programs within the context of the Combi, and without making any changes to the original Program data. You also get hands-on access to these edits, using the sliders, knobs, and switches.

You can freely change back and forth between the different functions, without losing any of your edits.

### 0–9a: Combi Select & Tempo

This section duplicates the most important information from the main Play page.

**Bank** [INT A–E, USER A–G]

This is the Bank of the current Combi.

**Combi** [000–127]

This is the current Combi.

**Tempo** [040.00...300.00, EXT]

This is the tempo for the current Combination, which applies to tempo-synced LFOs and Wave Sequences, the Vector EG, EXi Step Sequencers, KARMA, and tempo-synced effects.

**EXT** means that the tempo will sync to external MIDI clocks. For more information, see “Tempo” on page 417.

**040.00...300.00** allow you to set a specific tempo in BPM, with 1/100 BPM accuracy.

### 0–9b: Timbre 1–8/9–16

This Control Assign setting lets you adjust the volume, pan, EQ, and FX send settings for Timbres 1–16.

**Mixer Knobs** [Channel Strip, Individual Pan]

The Mixer Knobs switch is on the front panel, immediately to the right of the knobs, and is also duplicated in the on-screen display. The eight knobs can control two different sets of parameters, depending on the setting of this switch.

**Channel Strip:** With this setting, the eight knobs will control the Pan, EQ, and FX Send settings for the selected Timbre. Use the **TIMBRE/TRACK** button to select a group of 8 Timbres (1–8 or 9–16), and then use the **SELECT** buttons to choose the specific Timbre.



**Individual Pan:** With this setting, the knobs will control the Pan for the current group of Timbres. Knob 1 controls the pan for Timbre 1 (or 9), knob 2 controls the pan for Timbre 2 (or 10), and so on.

### Knobs 1–8, Channel Strip

When the Mixer Knobs switch is set to Channel Strip, the knobs provide quick access to the Pan, EQ, and FX Send parameters. The Pan and EQ parameters duplicate the similarly-named parameters found on the Combi editing pages; changing them here will change them in the editing pages, and vice-versa.

**Pan** [Random, L001...C064...R127]

This controls the stereo pan of the selected Timbre. A setting of **L001** places the sound at the far left, **C064** in the center, and **R127** to the far right.

**Random** is available only via the LCD. (Otherwise, it would be difficult to use the knob to sweep smoothly from left to right.) With the **Random** setting, each note will have a different, random pan position.

*Note:* With some EXi instruments, such as the CX-3, notes cannot be panned individually. For these EXi, **Random** pan will move all sounding notes to a different pan position at each note-on.

**EQ Trim** [00...99]

This controls the volume level going into the EQ.

High settings of the Low, Mid, and High Gain controls can cause substantial increases in the overall level. You can compensate for this by turning down the input trim.

*Note:* if the EQ page EQ Bypass parameter is turned On, then none of the EQ parameters here will have any effect.

**Low EQ** [–18.0...+18.0dB]

This controls the gain of the 80Hz Low Shelf EQ, in increments of 0.5dB.

**Mid EQ Freq** [100Hz...10.0kHz]

This sets the center frequency for the Mid sweep EQ.

**Mid EQ Gain** [–18.0...+18.0dB]

This controls the gain of the Mid Sweep EQ, in increments of 0.5dB.

**High EQ** [–18.0...+18.0dB]

This controls the gain of the 10kHz High Shelf EQ, in increments of 0.5dB.

**Send 1** [000...127]

This controls the send level into FX Send 1. If the Timbre’s **Output Bus** parameter is set to L/R or OFF, it scales the Oscillator send levels. If the **Output Bus** is set to IFX 1–12, it directly controls the post-IFX send levels.

**Send 2** [000...127]

This controls the send level into FX Send 2. For more details, see **Send 1**, above.

### Knobs 1–8, Individual Pan

When the Mixer Knobs switch is set to Individual Pan, the knobs will control the Pan for the current group of Timbres. Knob 1 controls the pan for Timbre 1, knob 2 controls the pan for Timbre 2, and so on.

These duplicate the Combi's Timbre Pan parameters; changing them here will change them in the editing pages, and vice-versa.

### **Pan 1/9** [Random, L001...C064...R127]

This controls the stereo pan of either Timbre 1 or Timbre 9, depending on whether the **TIMBRE/TRACK** button is set to 1–8 or 9–16.

A setting of **L001** places the sound at the far left, **C064** in the center, and **R127** to the far right.

**Random** is available only via the LCD. (Otherwise, it would be difficult to use the knob to sweep smoothly from left to right.) With the **Random** setting, the pan position will be different for each note-on.

*Note:* with some EXi sounds, such as the CX-3, **Random** pan may affect all notes at once.

### **Pan 2/10–8/16** [Random, L001...C064...R127]

These control the stereo pan of Timbres 2–8 or 10–16, depending on the setting of the **TIMBRE/TRACK** button. For more details, see **Pan 1/9**, above.

### **Play/Mute switches 1–8**

The top row of switches allow you to turn each of the Timbres on and off.

#### **Play/Mute 1/9** [Play, Mute]

This controls the play/mute status of either Timbre 1 or Timbre 9, depending whether the **TIMBRE/TRACK** button is set to 1–8 or 9–16.

When this switch is on (LED = on), Timbre 1 will play. When the switch is off (LED = off), Timbre 1 will be muted.

#### **Play/Mute 2/10–8/16** [Play, Mute]

These control the play/mute status of Timbres 2–8 or 10–16, depending on the setting of the **TIMBRE/TRACK** button.

For more details, see **Play/Mute 1/9**, above.

### **Solo switch and Select switches 1–8**

#### **Solo** [Off, On]

Solo lets you isolate one or more Timbres or Audio Inputs, so that you hear them by themselves. It does this by temporarily muting all non-soloed Timbres and Audio Inputs.

Solo uses the Select switches. These switches can show and control either which Timbre is currently selected, or which Timbres are soloed. The main Solo button lets you switch back and forth between the two views.

When the Solo button is **Off** (LED = Off), the Select switches select the current Timbre; when the Solo button is **On** (LED = On or blinking), the Select switches let you solo one or more Timbres.

When Solo is **On**, and one or more Timbres or Audio Inputs are soloed, the Solo LED will blink on and off to remind you that solo is in use.

*Note:* The main Solo button merely changes the functions of the Select switches. It does not enable or clear the individual solo states.

### **Clearing all solos**

To turn off **Solo** for all Timbres and Audio Inputs at once:

1. Press and hold the **RESET CONTROLS** button.
2. While holding **RESET CONTROLS**, press the **SOLO** button.

### **Exclusive Solo menu parameter**

The menu's **Exclusive Solo** parameter also affects the way that Solo works. When **Exclusive Solo** is **Off** (unchecked), you can solo multiple Timbres and Audio Inputs at once.

When **Exclusive Solo** is **On** (checked), only one Timbre or Audio Input can be soloed at a time. In this mode, pressing a Solo switch automatically disables any previous solos.

#### **Select 1–8/9–16** [Off, On]

These buttons either select or solo the Timbre, depending on the state of the **Solo** switch. For more details, see **Solo**, above.

### **Volume Sliders 1–8**

These sliders adjust the volume level of the Timbres.

#### **Volume 1/9** [000...127]

This controls the volume of either Timbre 1 or Timbre 9, depending on whether the **TIMBRE/TRACK** button is set to 1–8 or 9–16.

#### **Volume 2/10–8/16** [000...127]

These control the volume of Timbres 2–8 or 10–16, depending on the setting of the **TIMBRE/TRACK** button. For more details, see **Volume 1/9**, above.

### **Master Volume Slider**

#### **Master Volume** [000...127]

This controls the volume of the main stereo outputs, after the Total Effects. It does not affect Individual Outputs 1–4. For more information, see the diagram "Master Volume" on page 432.



Control Surface - Audio In

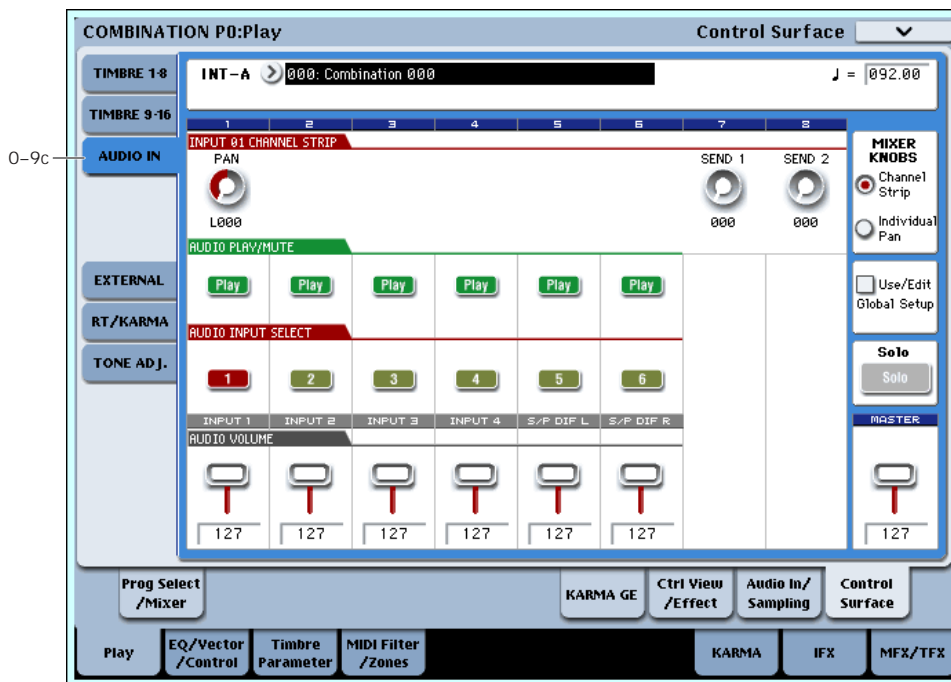

**0–9c: Audio Inputs**

This Control Assign setting lets you adjust the volume, pan, and FX send settings for each of the six audio inputs: Analog 1/2, USB 1/2, and S/P DIF left and right.

You can use this page to mix sounds from other sources into the KRONOS outputs - as an on-stage submixer, for instance.

In Sequencer mode, two additional Audio Control Assign settings are available: HDR 1–8 and HDR 9–16. These select the two banks of hard-disk recording tracks, for control of volume, pan, sends, EQ, solo, and mute.

**Use/Edit Global Setup [Off, On]**

Combis can use the single, Global audio input mixer setup, or can instead have their own custom settings.

When **Use/Edit Global Setup** is **On**, the Combi uses the Global settings. This is the default, and lets you change freely between different Programs and Combinations without affecting the audio inputs.

Also, any edits made on this page will affect the Global setting, along with any other Programs, Combis, or Songs which use the Global setting.

On the other hand, it may sometimes be convenient to save a particular mixer setup with an individual Combi, to set up special sub-mixer settings or effects processing for particular inputs. In this case, set **Use/Edit Global Setup** to **Off**, and the audio inputs will use the Combi’s custom settings.

**Mixer Knobs [Channel Strip, Individual Pan]**

This switch controls whether the knobs show the pan settings for all 6 inputs at once (Individual Pan), or the pan and FX Send levels for the selected input (Channel Strip). For more information, please see “Mixer Knobs” on page 431.

**Knobs 1–8, Channel Strip**

When the Mixer Knobs switch is set to Channel Strip, the knobs provide quick access to the selected input’s Pan and FX Send parameters.

**Pan [L000...C064...R127]**

This controls the stereo pan of the selected input. A setting of **L000** places the sound at the far left, **C064** in the center, and **R127** to the far right.

**Send 1 [000...127]**

This controls the send level into FX Send 1. If the input’s **Output Bus** parameter is set to L/R or OFF, it scales the programmed send level. If the **Output Bus** is set to IFX 1–12, it directly controls the post-IFX send levels, overwriting any previous setting.

**Send 2 [000...127]**

This controls the send level into FX Send 2. For more details, see “Send 1,” above.

**Knobs 1–6, Individual Pan**

When the Mixer Knobs switch is set to Individual Pan, knobs 1–6 control pan for each of the audio inputs. Knobs 7 and 8 have no effect.

**Audio Input Pan (1–6) [L000...C064...R127]**

Knobs 1 and 2 control the pan settings for analog inputs 1 & 2, knobs 3 and 4 control the pan for USB inputs 1 & 2, and knobs 5–6 control the pan for the left and right S/P DIF inputs. A setting of **L000** places the sound at the far left, **C064** in the center, and **R127** to the far right.

**Play/Mute switches 1–6**

The top row of switches allow you to mute any or all of the audio inputs.



**Play/Mute (1–6)**

**[Play, Mute]**

When this switch is on (LED = on), the input will be enabled. When the switch is off (LED = off), the input will be muted.

**Solo switch and Select switches 1–6**

**Solo**

**[Off, On]**

Solo lets you isolate one or more Timbres or Audio Inputs, so that you hear them by themselves. It does this by temporarily muting all non-soloed Timbres and Audio Inputs.

The Select switches can show and control either which Input is currently selected, or which Inputs are soloed. The main Solo button lets you switch back and forth between the two views.

When the Solo button is **Off** (LED = Off), the Select switches select the current Input; when the Solo button is **On** (LED = On or blinking), the Select switches let you solo one or more Inputs.

When Solo is **On**, and one or more Timbres or Audio Inputs are soloed, the Solo LED will blink on and off to remind you that solo is in use.

*Note:* The main Solo button merely changes the functions of the Select switches. It does not enable or clear the individual solo states.

For more information, see “Clearing all solos” on page 430, and “Exclusive Solo menu parameter” on page 430.

**Select (1–6)**

**[Off, On]**

This switch either selects or solos the input, depending on the Solo switch setting. For more details, see “Solo,” above.

**Sliders 1–6**

**Audio Input Volume (1–6)**

**[000...127]**

These sliders adjust the volume levels of the audio inputs.

**Master Volume Slider**

**Master Volume**

**[000...127]**

This controls the volume of the main stereo outputs, after the Total Effects. It does not affect Individual Outputs 1–4.

*Master Volume*

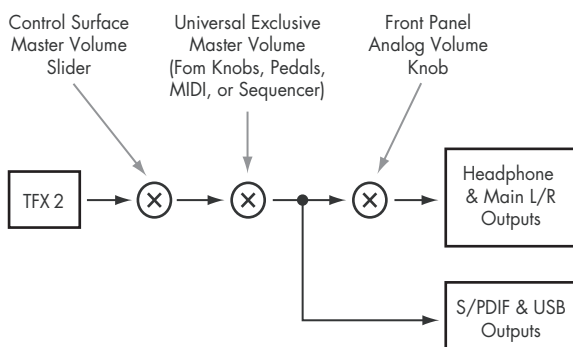

Control Surface - External

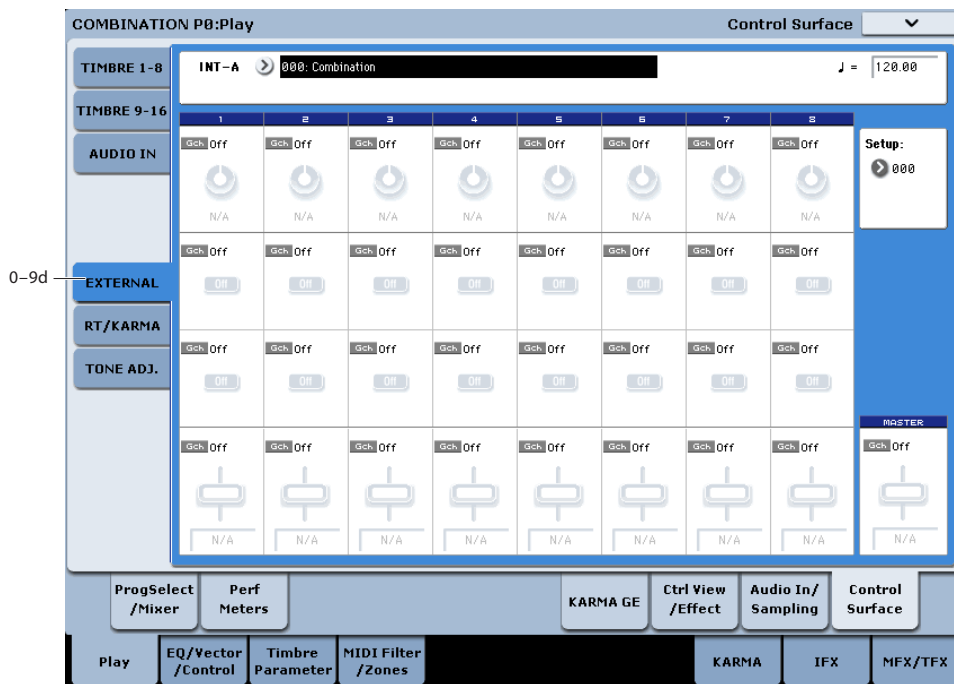

**0-9d: External**

This Control Assign setting lets you send MIDI messages to external devices. Each slider, knob, and switch can be assigned to a separate MIDI controller and MIDI channel. The eight pads also have separate assignments which apply only when Control Assign is set to External.

For instance, you might make one setup for controlling several different pieces of MIDI gear on stage, another for controlling a software synthesizer (such as one of Korg’s Legacy Collection synths), and so on.

These assignments are determined by the selected External Setup. The KRONOS has 128 External Setups, which can be edited in Global mode (see “1-2: External 1” on page 777).

When you select an External Setup, it stays selected even when you change Combinations or switch to another mode. This makes it easy to select different KRONOS sounds without disrupting external MIDI control, and vice-versa.

You can think of External mode as being a separate control surface which just happens to share KRONOS’s sliders, knobs, switches, and pads.

**Setup [000...127]**

This selects the External Setup for the knobs, sliders, switches, and pads.

**Note:** this selection is persistent for the entire KRONOS; is not stored with the Combination.

**Knobs 1-8**

**MIDI Channel (1-8) [01...16, Gch]**

This read-only parameter shows the MIDI Channel assigned to the knob. Each can send on a different channel, if desired.

**Gch** means that the knob will transmit on the Global MIDI Channel, as set in Global mode. This allows you to re-direct any number of sliders, knobs, switches, and on-screen pads to a different channel at once, without editing the individual controls.

**CC# Assign (1-8) [Off, 000...119]**

This read-only parameter shows the MIDI CC sent by the knob.

**Note:** to change the mapping of CCs to controls, edit the External Setups in Global P1-2: External 1. For more information, see “1-2: External 1” on page 777.

**Value (1-8) [000...127]**

This is the current value of the knob’s MIDI CC.

**Switches 1-16**

**MIDI Channel (1-16) [01...16, Gch]**

This read-only parameter shows the MIDI Channel for the switch. Each can send on a different channel, if desired.

**Gch** means that the slider will transmit on the Global MIDI Channel, as set in Global mode.

**CC# Assign (1-16) [Off, 000...119]**

This read-only parameter shows the MIDI CC sent by the switch.

**Switch On/Off (1-16) [Off, On]**

This is the current value of the switch’s MIDI CC. When the switch is turned on, it sends a value of 127; when it is turned off, it sends a value of 0.

**Sliders 1–8 & Master Slider**

**MIDI Channel (1–8)** [01...16, Gch]

This read-only parameter shows the MIDI Channel for the slider. Each can send on a different channel, if desired.

**Gch** means that the slider will transmit on the Global MIDI Channel, as set in Global mode.

Control Surface - RT/KARMA

**CC# Assign (1–8)** [Off, 000...119]

This read-only parameter shows the MIDI CC sent by the slider.

**Value (1–8)** [000...127]

This is the current value of the slider's MIDI CC.

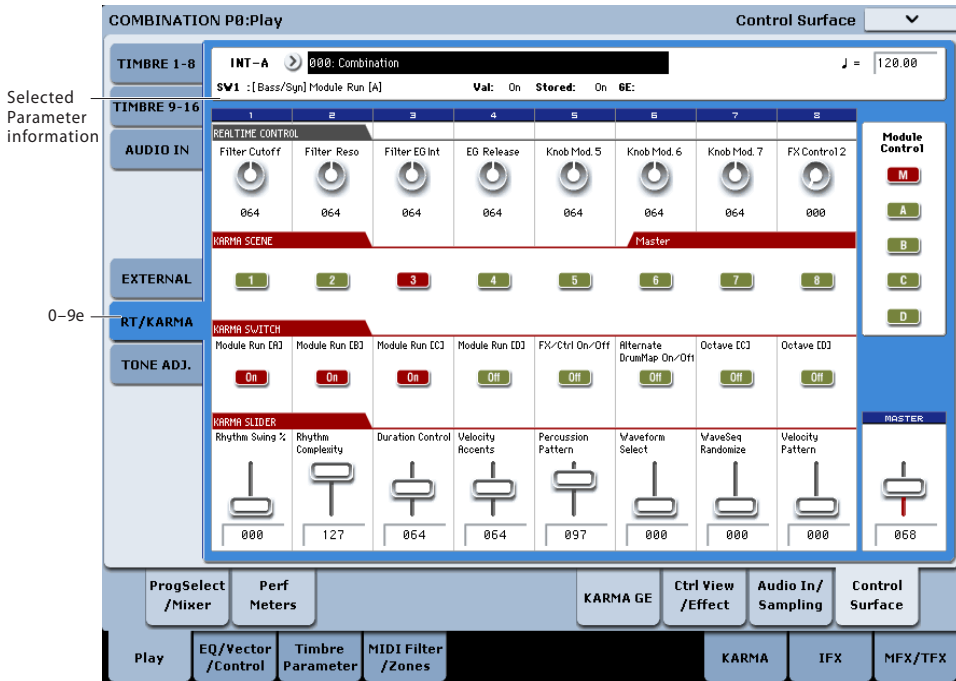

**0–9e: RT/KARMA (Real Time Knobs/KARMA)** AMSource

This Control Assign setting lets you modulate Program, Combi and Effects parameters with the eight knobs, and control KARMA with the switches and sliders.

**Selected parameter information**

When you select a KARMA Slider or Switch, this area shows detailed information about its KARMA parameter assignments.

**Control** [SW1...8, SL1...8]

This shows which Switch or Slider is currently selected.

**Assignment** [Name]

Each KARMA Slider or Switch can control multiple internal parameters simultaneously. The group of parameters can be given a single name, which is shown here.

You can select different names, if desired. For more information, see “7–9: Name/Note Map” on page 132.

**Module and Parameter** [A...D 01...32, P 01...08]

This read-only display shows the KARMA parameter(s) assigned to the Slider or Switch.

A, B, C, and D mean that the slider or switch controls a GE Real-Time Parameter from the corresponding KARMA Module. The following number identifies the specific parameter within the module. For instance, A22 is parameter 22 of Module A.

P means that the switch is controlling a Performance Real-Time Parameter.

You can assign many parameters to a single slider or switch, if desired. Due to space limitations, however, only the first five parameters will be shown here.

To change the parameter assignments, use the KARMA GE RTP and Perf RTP pages. For more information, please see “7–5: GE Real-Time Parameters/Scenes” on page 120, and “7–6: Perf Real-Time Parameters” on page 123.

**Parameter Value** [Depends on parameter]

This shows the value of the GE or Performance Real-Time Parameters assigned to the selected Slider or Switch. The range can vary, depending on the individual parameters.

**KARMA Module Control**

**Module Control** [M, A, B, C, D]

When used to control KARMA, the Control Surface sliders and switches are five layers deep: one for each Module (A-D), and a Master Layer capable of

controlling selected parameters from all of the Modules at once. Each layer has its own Slider, Switch, and Scene settings.

The **Module Control** radio buttons (and the front-panel **MODULE CONTROL** button) let you switch between these five layers.

To select a different layer, just press its on-screen radio button, or use the front-panel **MODULE CONTROL** button to step through each layer in turn. When you do so, all of the KARMA Sliders, Switches and Scenes will update instantly to show their current values and names within the selected layer.

### Knobs 1–8

Knobs 1–4 all have dedicated functions which correspond to MIDI CCs. Knobs 5–8 can be assigned to a wide variety of functions, many of which also have corresponding MIDI CCs.

When you move the knob, it will send the corresponding MIDI CC to all Timbres on the Global Channel. (To edit individual Programs, use Tone Adjust instead.)

Also, when the CC is received via MIDI or generated by KARMA, the knob value will change to match the CC value.

Note that the Knob 1–8 settings of the individual Programs do not apply in Combi mode.

Unless otherwise noted, “scaling” means that the parameters are at their programmed values when the controller is at 64, at their minimum when the controller is at 0, and at their maximum when the controller is at 127. For another look at this, see the diagram below.

CC scaling of parameters

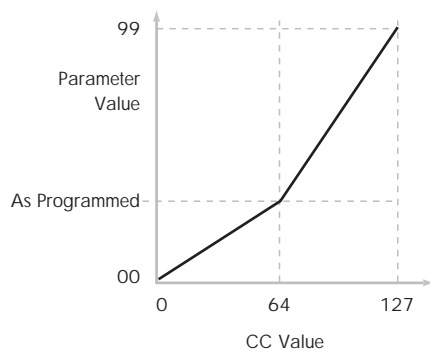

### Knob 1: CUTOFF (CC#74) [000...127]

This knob scales the cutoff frequencies of Filters A and B, and transmits and receives MIDI CC #74.

### Knob 2: RESONANCE (CC#71) [000...127]

This knob scales the resonance of Filters A and B, and transmits and receives MIDI CC #71.

### Knob 3: Filter EG Intensity (CC#79) [000...127]

This knob scales the effect of the Filter EG on the cutoff frequencies of Filters A and B. It also transmits and receives MIDI CC#79.

### Knob 4: EG Release (CC#72) [000...127]

This knob scales the release time of the Filter and Amp EGs, and transmits and receives MIDI CC#72.

### Knobs 5–8 [000...127]

You can set knobs 5–8 to a wide variety of modulation functions, using the Controller Setup page (P1–8).

Many of the functions scale a particular set of Program parameters. All of the settings also correspond to MIDI messages—usually CCs.

### KARMA SCENES 1-8

#### KARMA Scenes [1...8]

A KARMA SCENE includes the settings for all of the KARMA SLIDERS and SWITCHES. Each Combi can contain up to eight Scenes.

To select a Scene, just press its switch - you’ll see all of the KARMA SLIDERS and SWITCHES update instantly to their new values.

### KARMA SWITCHES 1-8

#### KARMA Switches [Off, On]

These switches control KARMA Performance or GE (Generated Effect) Real-Time Parameters, as assigned on the KARMA Perf RTP and GE RTP pages.

The switches indicate the current on/off status.

The parameters assigned to the switches and their on/off status can be edited in the GE RTP page or the KARMA Perf RTP page.

### KARMA SLIDERS 1-8

#### KARMA Sliders [000...127]

These sliders control KARMA Performance or GE Real-Time Parameters, as assigned on the KARMA Perf RTP and GE RTP pages.

The current values are shown under the sliders. The parameters assigned to the sliders and their value can be edited in the GE RTP page or the KARMA Perf RTP page.

### Master Volume Slider

#### Master Volume [000...127]

This controls the volume of the main stereo outputs, after the Total Effects. It does not affect Individual Outputs 1–4. For more information, see the diagram “Master Volume” on page 432.

Control Surface - Tone Adjust

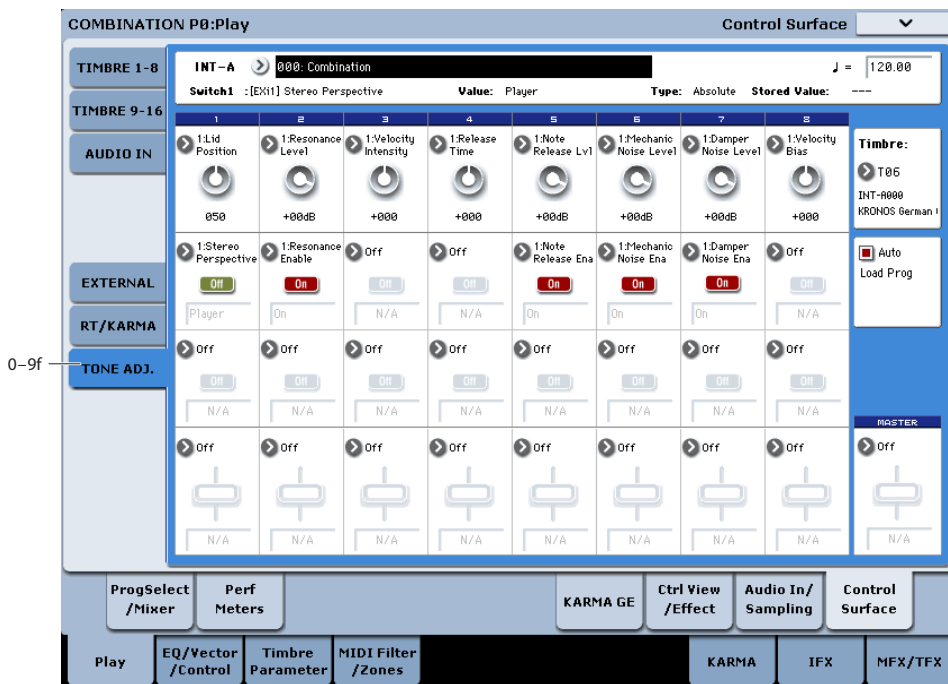

**0-9f: Tone Adjust**

Tone Adjust provides two important features simultaneously:

- It lets you use all of the sliders, knobs, and switches to control Program parameters - like the knobs on an analog synth, or the drawbars on an organ.
- It lets you modify Programs for use within a specific Combi, including everything from subtle tweaks (like changing LFO speeds) to dramatic changes (such as selecting a different Multisample). Any changes that you make are stored with the Combi, and do not alter the original Program.

Each of the sixteen Timbres has its own set of tone adjust parameters, but only one Timbre is shown at a time.

For more information, see:

- “Tone Adjust and MIDI SysEx” on page 30
- “Interaction between Tone Adjust and MIDI CCs” on page 30
- “Absolute, Relative, and Meta parameters” on page 30

**Saving Tone Adjust Edits**

In Program mode, when you make edits via Tone Adjust and then save the results, the Program data is changed—just as if you’d edited the internal parameters directly. For more information, see “Saving Tone Adjust Edits” on page 30.

In Combi mode, however, all Tone Adjust edits are stored within the Combi; the Program itself is not changed. This lets you alter the way that a Program sounds in one specific Combi without affecting the way that it sounds in Program mode, or in any other Combis or Songs.

**Timbre select**

**Timbre [1...16]**

This selects the Timbre whose Tone Adjust parameters appear on the screen and the Control Surface. You can switch back and forth between the different Timbres as much as you like, without losing your edits.

This parameter is the same as the selected Timbre in TIMBRE/TRACK mode; changing one will also change the other.

You can use a shortcut to change the current Timbre directly from the Control Surface, without leaving Tone Adjust mode:

1. **Press and hold the TONE ADJ./EQ button.**
2. **While holding TONE ADJ./EQ, press a PLAY/MUTE or SELECT button to select a Timbre.**

The PLAY/MUTE buttons select Timbres 1-8, and the SELECT buttons select Timbres 9-16.

3. **Release the TONE ADJ./EQ button.**

The Control Surface and screen will change to show the Tone Adjust parameters for the newly selected Timbre.

**Auto Load PRG [Off, On]**

When you first load a Program into a Timbre, this parameter determines whether or not the Program’s Tone Adjust settings will be loaded as well.

These settings include the parameters assigned to each slider, knob, and switch, along with the on/off state of any Switches assigned to Absolute parameters.

Note that any edits you’ve made using Tone Adjust in Program mode will already have been stored into the Program’s parameters. This means that the Program will still sound the same, whether or not you load the Tone Adjust settings.

Once the Program has been loaded, you can change any or all of the Tone Adjust settings as desired, including both assignments and values. All such edits are stored in the Combi, without affecting the original Program.

If **Auto Load PRG** is **On**, Tone Adjust settings will be automatically loaded along with the Program.

If **Auto Load PRG** is **Off**, then the relationship between the types of the old and new Programs will determine what happens, as shown in the table below:

If the old Program is...	And the new Program is...	Then Tone Adjust parameters and values are...
An HD-1 Program	An HD-1 Program	kept the same
A HD-1 Program	An EXi Program	loaded from the new Program
Any EXi Program	A HD-1 Program	loaded from the new Program
An EXi Program	An EXi Program with the same EXi assigned to the same slots as the previous Program	kept the same
An EXi Program	An EXi Program which does <b>not</b> use the same EXi as the previous Program	loaded from the new Program

**Selected parameter information**

This status line shows detailed, read-only information about the currently selected Tone Adjust parameter.

**(Control)** [Knob1...8, SW1...16, Slider1...8, Slider M]

This is the physical controller assigned to the Tone Adjust parameter. **Slider M** is the Master Slider.

**(Assignment)** [Full Parameter Name]

This shows the full name of the parameter assigned to the controller. You can change this using the “Assign” parameter, below.

**Value** [Current Parameter Value]

This shows the current value of the parameter. The range of values will vary depending on the parameter assigned to the control.

**Type** [Relative, Absolute, Meta]

This shows the type of the parameter, which relates to how edits to the parameter are saved. For more information, see “Absolute, Relative, and Meta parameters” on page 30.

**Stored Value** [Original Parameter Value]

This shows the original value of the parameter, before the effects of Tone Adjust. It applies only to Tone Adjust parameters which control a single Program parameter.

If you un-assign a parameter from a control, it will revert to this value.

**Knobs 1–8**

**Assign** [List of Tone Adjust assignments]

This lets you assign a Tone Adjust parameter to the knob.

The first group of parameters are the Common set, which are supported by most Program types. For a full list, see “Common Tone Adjust Parameters” on page 438.

After the Common parameters, the items in the list will vary depending on the Program type. For more information, please see:

“HD-1 Tone Adjust Parameters,” on page 33.

“AL-1: Tone Adjust,” on page 222.

“CX-3: Tone Adjust,” on page 244.

“STR-1: Tone Adjust” on page 292.

“MS-20EX Tone Adjust parameters” on page 319

“PolysixEX Tone Adjust parameters” on page 335.

Other EXi instruments will have their own set of parameters, as described in their manuals.

**Assignments are exclusive**

Each controller can be assigned to only one parameter, and each parameter can be assigned to only one controller.

To swap a parameter from one control to another, you’ll need to first un-assign it from the old control, and then assign it to the new control.

**Value** [Depends on parameter]

This shows the current value of the parameter. The range of values will vary depending on the parameter assigned to the control.

**Switches 1–16**

Tone Adjust switches act a little differently than knobs and sliders.

When a switch is assigned to a **Relative** parameter, or an **Absolute** parameter with more than two states:

Switch On = **On Value** (see below)

Switch Off = the Program’s stored value

When a switch is assigned to a two-state **Absolute** parameter, such as **Hold**, the switch status directly reflects the parameter value:

Switch On = **On**

Switch Off = **Off**

**Assign** [List of Tone Adjust assignments]

This lets you assign a Tone Adjust parameter to the switch. For more information, see “Assign,” above.

**On Value** [Depends on parameter]

The parameter is set to this value when the switch is On.

When the switch is assigned to a two-state **Absolute** parameter, such as **Hold**, this will always be the same as the **Switch Status** (see below).

### Switch Status

[Off, On]

This simply shows whether the switch is On or Off. The status is also shown by the LEDs in the physical buttons.

### Sliders 1–8 and Master Slider

These work identically to Knobs 1–8, as described above.

---

## Common Tone Adjust Parameters

These parameters affect both Oscillators in a HD-1 Program, or both EXi in an EXi Program. Some EXi instruments may not support all of the Common Tone Adjust parameters; for details, please see the individual EXi manuals.

Unless otherwise noted, all of the following Tone Adjust parameters are **Relative**.

**Off.** This means that the Tone Adjust control has no effect.

**Filter Cutoff.** This scales the cutoff frequency of all of the filters at once. For instance, in the HD-1, it affects both Filters A and B.

This parameter interacts with CC# 71.

**Filter Resonance.** This scales the resonance of all of the filters at once - for instance, in the HD-1, it affects both Filters A and B. It interacts with CC# 74.

**Filter EG Intensity.** This scales the effect of the Filter EG on the cutoff frequency. It affects all of the filters at once; for instance, in the HD-1, it affects both Filters A and B.

–99 means no modulation. +99 means maximum modulation in the same direction, positive or negative, as the original Program. For instance, if the original Program's EG Intensity was set to –25, then setting the Tone Adjust to +99 moves the EG Intensity to –99.

This parameter interacts with CC# 79.

**Amp Velocity Intensity.** This scales the effect of velocity on the Amp level.

–99 removes the velocity modulation entirely. +99 means maximum modulation in the same direction, positive or negative, as the original Program.

**Filter/Amp EG Attack Time.** This scales the attack times of the Filter and Amp EGs, along with other related parameters.

When the value is +1 or more, this also affects the Amp EG's Start and Attack Levels, Start Level AMS, and Attack Time AMS, as described below:

Between values of +1 and +25, the Start Level, Start Level AMS, and Attack Time AMS will change from their programmed values to 0. Over the same range, the Attack Level will change from its programmed value to 99.

This parameter interacts with CC# 73.

**Filter/Amp EG Decay Time.** This scales the decay and slope times of the Filter and Amp EGs. It interacts with CC# 75.

**Filter/Amp EG Sustain Level.** This scales the sustain levels of the Filter and Amp EGs. It interacts with CC# 70.

**Filter/Amp EG Release Time.** This scales the release times of the Filter and Amp EGs. It interacts with CC# 72.

**Filter EG Attack Time.** This scales the attack times of the Filter EGs.

**Filter EG Decay Time.** This scales the decay and slope times of the Filter EGs.

**Filter EG Sustain Level.** This scales the sustain levels of the Filter EGs.

**Filter EG Release Time.** This scales the release times of the Filter EGs.

**Amp EG Attack Time.** This scales the attack times of the Amp EGs.

**Amp EG Decay Time.** This scales the decay and slope times of the Amp EGs.

**Amp EG Sustain Level.** This scales the sustain levels of the Amp EGs.

**Amp EG Release Time.** This scales the release times of the Amp EGs.

**Pitch EG Attack Time.** This scales the attack times of the Pitch EG (or EGs, in the case of some EXi instruments).

**Pitch EG Decay Time.** This scales the decay and slope times of the Pitch EG (or EGs, in the case of some EXi instruments).

**Pitch EG Sustain Level.** This scales the sustain levels of the Pitch EG (or EGs, in the case of some EXi instruments). **Note:** this does not apply to the HD-1.

**Pitch EG Release Time.** This scales the release times of the Pitch EG (or EGs, in the case of some EXi instruments). It interacts with CC# 77.

**Pitch LFO1 Intensity.** This scales the effect of LFO1 on the Pitch.

–99 removes the LFO modulation entirely. +99 means maximum modulation in the same direction, positive or negative, as the original Program.

**LFO1 Speed.** This scales LFO1's frequency. When the LFO is in MIDI/Tempo mode, this adjusts the Base Note. For more information, please see "Frequency" on page 93.

This parameter interacts with CC# 76.

**LFO1 Fade.** This scales LFO1's fade-in time. For more information, please see "Fade" on page 94.

**LFO1 Delay.** This scales LFO1's delay time - the time between note-on and the onset of the LFO. For more information, please see "Delay" on page 94.

This parameter interacts with CC# 78.

**LFO1 Stop.** This **Absolute** parameter controls whether LFO1 is stopped or running. For more information, please see "Stop" on page 93.

The **PROG** setting restores the Program's original values - convenient if Oscillator 1's LFO was stopped, but Oscillator 2's was not.

**LFO2 Speed.** This scales LFO2's frequency. When the LFO is in MIDI/Tempo mode, this adjusts the Base Note. For more information, please see "Frequency" on page 93.



**LFO2 Fade.** This scales LFO2's fade-in time. For more information, please see "Fade" on page 94.

**LFO2 Delay.** This scales LFO2's delay time - the time between note-on and the onset of the LFO. For more information, please see "Delay" on page 94.

**LFO2 Stop.** This **Absolute** parameter controls whether LFO2 is stopped or running. For more information, please see "Stop" on page 93.

**Common LFO Speed.** This scales the Common LFO's frequency. When the LFO is in MIDI/Tempo mode, this adjusts the Base Note.

**Unison.** This **Absolute** parameter turns **Unison** on and off. For more information, please see "Unison" on page 38.

**Number Of Voices.** This **Absolute** parameter sets the number of Unison voices. If **Unison** is not **On**, this parameter has no effect. For more information, please see "Number of voices" on page 38.

**Detune.** This **Absolute** parameter sets amount of detuning between the Unison voices. If **Unison** is not **On**, this parameter has no effect. For more information, please see "Detune" on page 38.

**Thickness.** This **Absolute** parameter sets the pattern of detuning between the Unison voices. If **Unison** is not **On**, or if **Detune** is set to 0, this parameter has no effect. For more information, please see "Thickness" on page 39.

---

## ▼ 0–9: Page Menu Commands

The number before each command shows its ENTER + number-key shortcut. For more information on these shortcuts, see "ENTER + 0-9: shortcuts for menu commands" on page 147.

- **0: Write Combination.** For more information, see "Write Combination" on page 501.
- **1: Exclusive Solo.** For more information, see "Exclusive Solo" on page 147.
- **2: Copy From Program.** For more information, see "Copy From Program" on page 501.
- **3: Add to Set List.** For more information, see "Add To Set List" on page 148.
- **4: Copy Tone Adjust.** This is available only when **Control Assign** is set to **Tone Adjust**. For more information, see "Copy Tone Adjust" on page 503.
- **5: Reset Tone Adjust.** This is available only when **Control Assign** is set to **Tone Adjust**. For more information, see "Reset Tone Adjust" on page 503.
- **6: Copy Scene.** This is available only when **Control Assign** is set to **RT KNOBS/KARMA**. For more information, see "Copy Scene" on page 157.
- **7: Swap Scene.** This is available only when **Control Assign** is set to **RT KNOBS/KARMA**. For more information, see "Swap Scene" on page 157.

# Combination P1: EQ/Vector/Controller

## 1-1: Timbre EQ

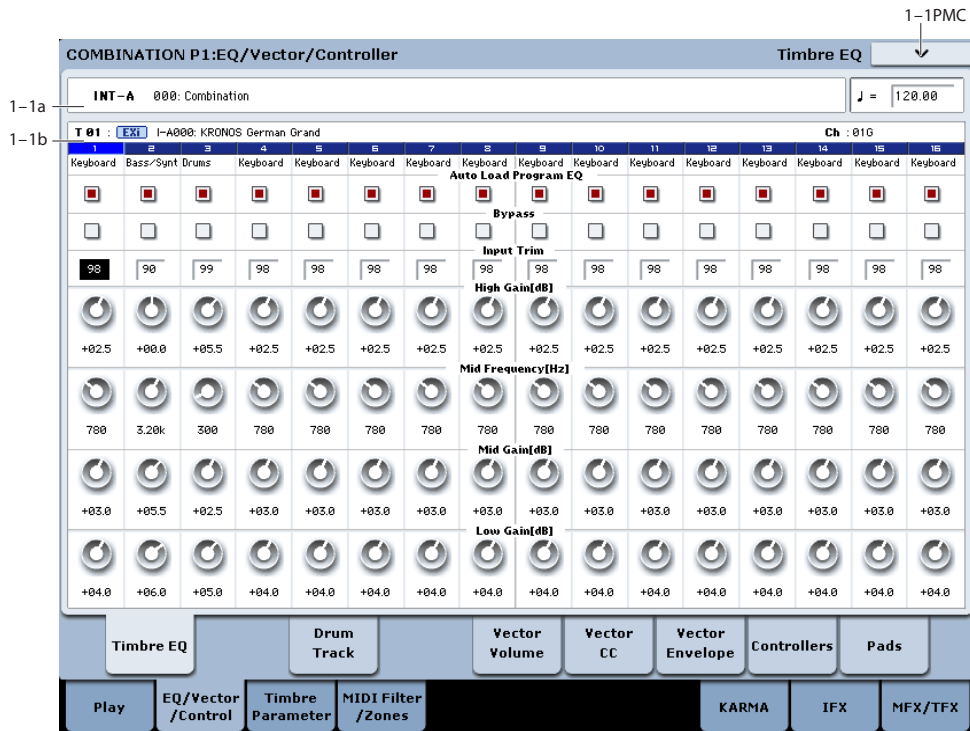

Each Timbre has a dedicated three-band EQ, with sweepable mid band. This page lets you view and adjust the settings for all 16 Timbres at once.

### Timbre EQ and the control surface

You can use the Control Surface to adjust almost all of the Timbre EQ parameters (except for **Bypass**). To do so:

1. Press the CONTROL ASSIGN MIXER TIMBRE/TRACK switch to select either timbres 1-8 or 9-16.
2. Use the MIX SELECT 1/9-8/16 switches to select the timbre you want to control.
3. Press the MIXER KNOBS switch to select CHANNEL STRIP.
4. Use the MIX CHANNEL STRIP knobs 2-6 to adjust the EQ TRIM, LOW EQ gain, MID EQ frequency and gain, and HIGH EQ gain, as desired.

### 1-1a: Combination Name

**Bank** [INT-A...G, USER-A...G]

**Combination Name** [(000...127: Name)]

These display-only parameters show the bank, number, and name of the current Combination.

### ♪ (Tempo) [040.00...300.00, EXT]

This is the tempo for the current Combination, which applies to tempo-synced LFOs and Wave Sequences, the Vector EG, EXi Step Sequencers, KARMA, and tempo-synced effects.

EXT means that the tempo will sync to external MIDI clocks. For more information, see "Tempo" on page 417.

040.00...300.00 allow you to set a specific tempo in BPM, with 1/100 BPM accuracy.

### 1-1b: 3 Band Parametric EQ

Selected Timbre Info — T 01 : EXi I-A000: KRONOS German Grand  
 Timbre Number — 1 2 3 4  
 Timbre Category — Keyboard Bass/Synt Drums Keyboard

#### Selected Timbre Info

This area displays information about the timbre selected for editing – T: timbre number/program bank/number/name, Ch: MIDI channel number.

#### Timbre Number

This indicates the timbre number. The various parameters below each timbre number make settings for the corresponding timbre.

#### Timbre Category

This shows the abbreviated category name of the Program assigned to the Timbre.

### Timbre 01 (Timbre Number)

#### Auto Load Prog EQ [Off, On]

When you first load a Program into a Timbre, this parameter determines whether or not the Program's EQ settings will be loaded as well.

Once the Program has been loaded, you can change any or all of the EQ settings as desired. All such edits are stored in the Combination, without affecting the original Program.

Regardless of this setting, subsequent edits to the Program's EQ in Program mode will not affect the Combination.

**On:** the Program's EQ settings will be loaded automatically along with the Program. This is the default setting.

**Off:** the Program's EQ settings won't be loaded. Use this if you've set up the EQ in a specific way, and then want it to stay unchanged while you try out different Programs.

#### Bypass [On, Off]

If this is **On (checked)**, all of the EQ will be disabled, including "Input Trim." Bypass can be convenient for comparing the results of the EQ with the original signal.

#### Input Trim [00...99]

This controls the volume level going into the EQ. Note that this parameter uses a linear scale; 50 is equivalent to -6dB, 25 is the same as -12dB, and so on.

High settings of the Low, Mid, and High Gain controls can cause substantial increases in the overall level. You can compensate for this by turning down the input trim.

#### High Gain [-18.0...+00.0...+18.0dB]

This controls the gain of the 10kHz High Shelf EQ, in increments of 0.5dB.

#### Mid Frequency [100Hz...10kHz]

This sets the center frequency for the Mid sweep EQ.

#### Mid Gain [-18.0...+00.0...+18.0dB]

This controls the gain of the Mid Sweep EQ, in increments of 0.5dB.

#### Low Gain [-18.0...+00.0...+18.0dB]

This controls the gain of the 80Hz Low Shelf EQ, in increments of 0.5dB.

### Timbre 02... 16 (Timbre Number)

These parameters adjust the three-band EQ (with sweepable mid range) for timbres 2 through 16. They are the same as for timbre 1. See "Timbre 01".

## ▼ 1–1: Page Menu Commands

The number before each command shows its ENTER + number-key shortcut. For more information on these shortcuts, see "ENTER + 0-9: shortcuts for menu commands" on page 147.

- 0: **Write Combination.** For more information, see "Write Combination" on page 501.
- 1: **Exclusive Solo.** For more information, see "Exclusive Solo" on page 147.
- 2: **Copy From Program.** For more information, see "Copy From Program" on page 501.
- 3: **Show EQ Graphic.** For more information, see "Show EQ Graphic" on page 503.

## 1–3: Drum Track

This page lets you set up the Drum Track, including the Pattern, MIDI Channel, and trigger settings.

For more details, please see "Using the Drum Track in Combination mode" on page 240 of the Operation Guide.

### 1–3a: Drum Pattern

#### Bank [Preset, User]

This selects between Preset and User Patterns.

The Patterns in the Preset bank are from the factory, and can't be changed.

The User bank Patterns are editable; you can load them from disk, or create new ones in Sequencer mode.

#### Pattern [(Preset): P000...P697, (User): U000...U999]

This chooses the Pattern from the selected Bank.

#### Shift [-24...+24]

**Shift** lets you transpose the Drum Track pattern in semitone steps, causing different instruments of the drum kit to play. This will generally cause unexpected results, which may often be interesting—experiment and see!

### 1–3b: MIDI Channel

#### Output [01...16, Gch]

Unlike Program mode, Combination mode does not have a dedicated track for the Drum Track. Instead, you can assign it to any of the 16 Timbres.

To do so, select a drum Program for the desired Timbre. Then, set the **Output** to match the Timbre's MIDI channel.

If the Timbre's **Status** is EXT or EX2, the Drum Track pattern will be transmitted via MIDI out

### 1-3c: Trigger

**Mode** [Start Immediately, Wait KBD Trig]

**Latch** [On, Off]

**Sync** [On, Off]

These control the way in which the Drum Pattern starts and stops. They work just like the similar parameters in Program mode. For details, please see “1-3c: Trigger” on page 43.

### 1-3d: Keyboard Trigger Zone

**Keyboard Top** [C-1...G9]

**Bottom** [C-1...G9]

**Velocity Top** [1...127]

**Bottom** [1...127]

These settings specify the range of keys and velocities that will trigger the Drum Track pattern when you play the keyboard (or the system receives a note-on via

MIDI). They work just like the similar parameters in Program mode. For details, please see “1-3d: Keyboard Trigger Zone” on page 43.

### ▼ 1-3: Page Menu Commands

The number before each command shows its ENTER + number-key shortcut. For more information on these shortcuts, see “ENTER + 0-9: shortcuts for menu commands” on page 147.

- 0: **Write Combination**. For more information, see “Write Combination” on page 501.
- 1: **Exclusive Solo**. For more information, see “Exclusive Solo” on page 147.
- 13: **Copy Drum Track**. For more information, see “Copy Drum Track” on page 506.
- 14: **Erase Drum Track Pattern**. For more information, see “Erase Drum Track Pattern” on page 635.

## 1-5: Vector Volume Control

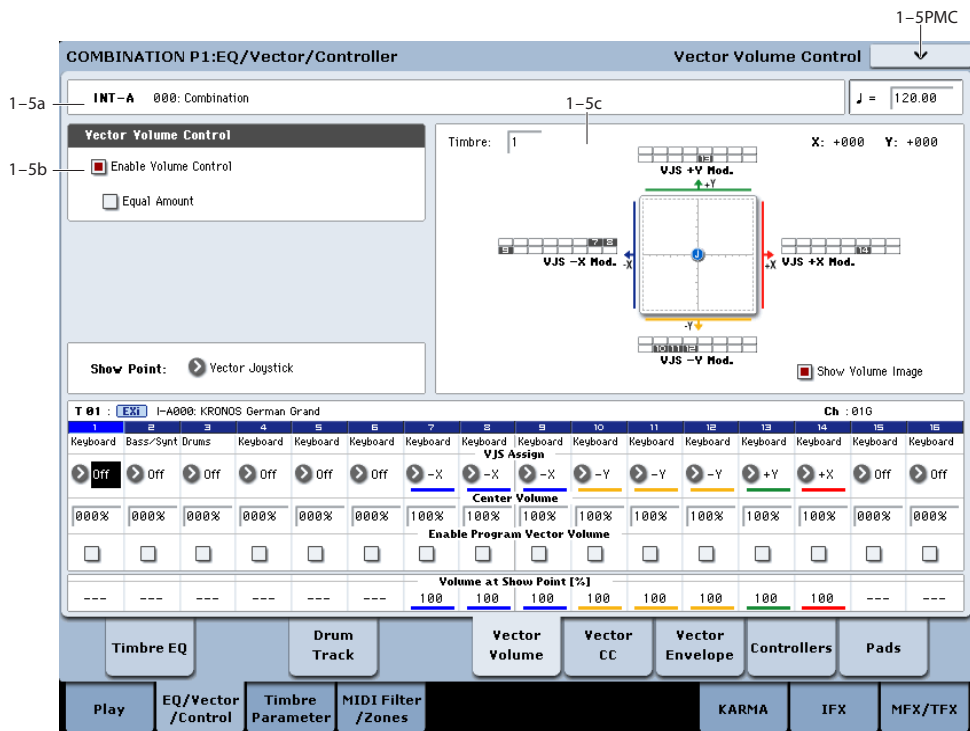

Vector Synthesis lets you control Timbre volumes and Program & Effects parameters by moving the Vector Joystick, by using the programmable Vector Envelope, or by the combination of the two.

For more background information on Vector Synthesis, please see “What does Vector mean?” on page 46, and “Vector Joystick and Vector Envelope” on page 46.

### Program and Combi Vectors work together

In Combi mode, each Timbre’s Program still has its own Vector EG, which controls volume and CCs as it did in Program mode. You can disable the Program Vector Volume and CC control separately for each Timbre, if desired.

There is also a separate Combi-wide Vector EG, with its own Vector Volume and CC control settings. As with the Program Vector, you can disable the Combi Volume and CC control separately for each Timbre.

### How Combi Vector Volume works

In Program mode, Vector Volume fades between the two Oscillators. Oscillator 1 is always at maximum volume when the Vector position is all the way to the left (–X), and Oscillator 2 is always at maximum when the Vector Position is all the way to the right (+X).

In Combi mode, on the other hand, the Vector can fade between any or all of the 16 Timbres. You can assign each of the Timbres to be controlled by any of the four Vector axes (+X, –X, +Y, –Y), or to not be controlled at all.

This lets you set up complex transitions between different Programs, including between HD-1 and different EXi instruments.

---

### 1–5a: Combination Name

**Bank** [INT–A...G, USER–A...G]

**Combination Name** [(000...127: Name)]

These display-only parameters show the bank, number, and name of the current Combination.

**J(Tempo)** [040.00...300.00, EXT]

This is the tempo for the current Combination, which applies to tempo-synced LFOs and Wave Sequences, the Vector EG, EXi Step Sequencers, KARMA, and tempo-synced effects.

EXT means that the tempo will sync to external MIDI clocks. For more information, see “Tempo” on page 417.

040.00...300.00 allow you to set a specific tempo in BPM, with 1/100 BPM accuracy.

---

### 1–5b: Vector Volume Control

Vector Volume Control lets you adjust the relative volumes of the 16 Timbres by moving the Vector Joystick (or the Vector Envelope) from left to right on the X axis, and up and down on the Y axis.

The **Equal Amount** check-box makes the Vector create a smooth fade between the Timbres, while the individual Timbre **Center Volume** parameters allow you to create more complex fade shapes.

**Enable Volume Control** [Off, On]

When this box is checked, the Vector position will control the volumes of all Timbres whose **VJS Assign** parameter is not set to **Off**.

When this box is not checked, the Vector position will not directly affect volume. However, it’s still possible for the Vector to control volume via Vector CCs and AMS, depending on the individual Program’s parameter settings.

**Equal Amount** [Off, On]

This applies only when **Enable Volume Control** is **On**.

When **Equal Amount** is **On**, the Vector will fade between all four Vector axes while maintaining a total amount of 100%. This provides a smooth fade between the different sounds, and is the type of volume control used by classic Vector synths.

Note that this will work best when the Programs assigned to each of the four axes have equivalent volumes. For instance, you might create a Combi with four Programs, each sounding at the same volume and assigned to a different axis. You could then add a fifth Program, assign it to one of the axes, and then use the Timbre volume sliders to reduce the levels of both Programs on that axis by 50%—so that their combined volume is the same as any one of the other Programs.

Also, when this is checked, the **Center Volume** parameters will be grayed out, since **Equal Amount** sets them automatically.

When **Equal Amount** is **Off**, the individual Timbre **Center Volume** parameters determine the way in which Vector position affects volume.

*Note:* For an interesting variation on this effect, turn **Equal Amount Off**, and instead set all of the Timbre **Center Volumes** to 50%. The Timbres will still fade together smoothly, but with a more gentle effect towards the extremes of the Vector axes.

---

### 1–5c: Vector Graphic

#### Vector Graphic

This shows a diagram of the vector space, including the five points of the Vector EG (labeled 0–4) and the current position of the Vector Joystick (labeled J).

The transitions between the EG’s points are shown by black lines, and the loop transition is shown by a gray line.

**Show Volume Image** [Off, On]

The vector graphic includes an image representing the Vector Volume Control settings for the current Timbre (see **Timbre Select**, below). You can use the **Show Volume Image** check-box to toggle this part of the graphic on and off.

**Timbre Select** [01...16]

This selects the Timbre whose volume image will be shown.

**Show Point** [VJS, Vector EG Point 0...4]

You can view the volume and CC values for the current position of the Vector Joystick, or for any of the EG’s five points. This selects the point whose values will be shown.

#### Timbre Volume & CC Display

This read-only display shows the volume and CC values for the current Vector point, as selected by the Show Point parameter, above.

# Combination mode

Vector Synthesis system, Combi mode

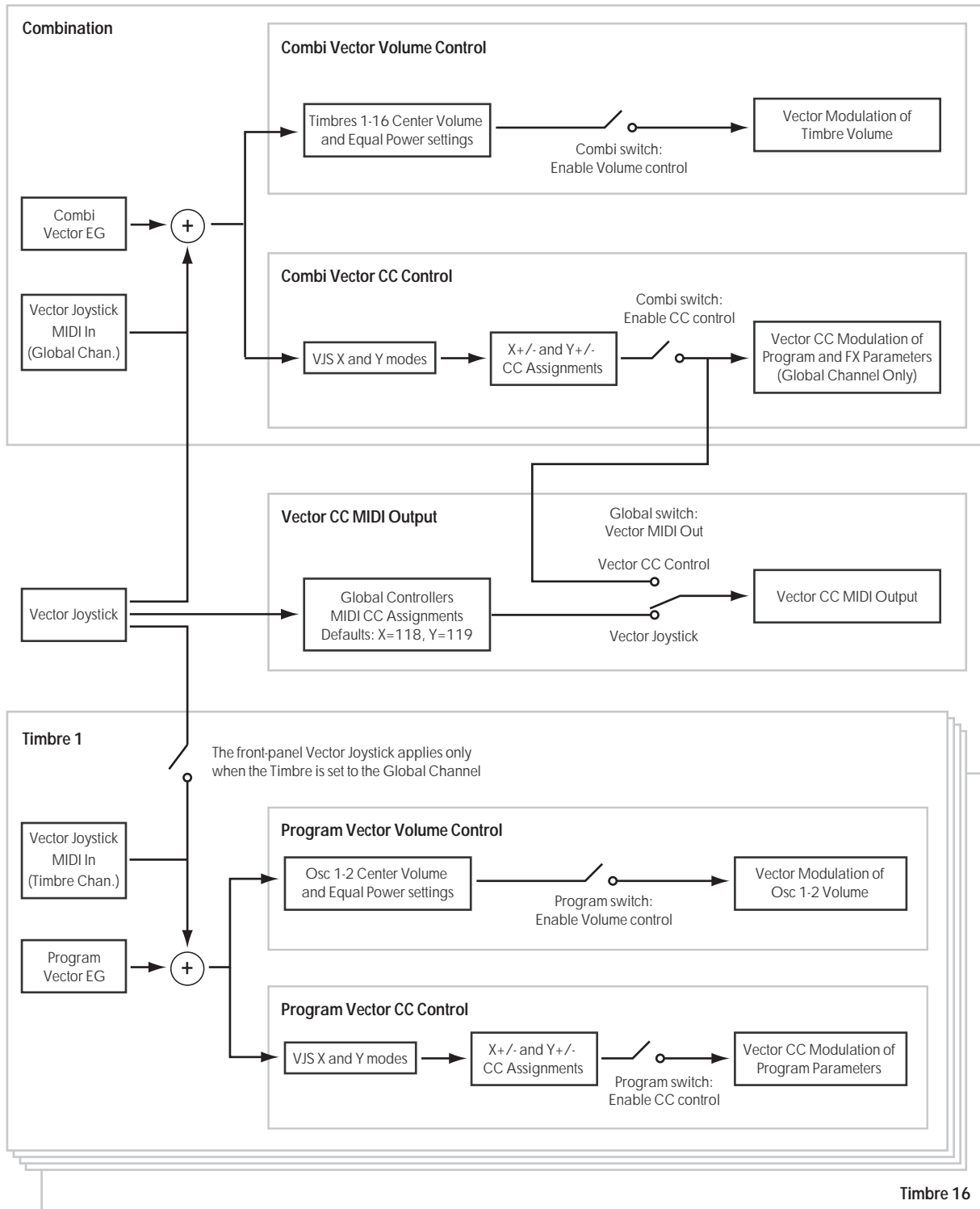

**Timbre 01**

**VJS Assign [Off, +X, -X, +Y, -Y]**

This assigns an axis of the Vector to control the Timbre's volume. See the diagram "VJS Assign and Program Volume," below, for more details.

**Off** means that the Vector position will not affect the Timbre's volume.

*VJS Assign and Program Volume*

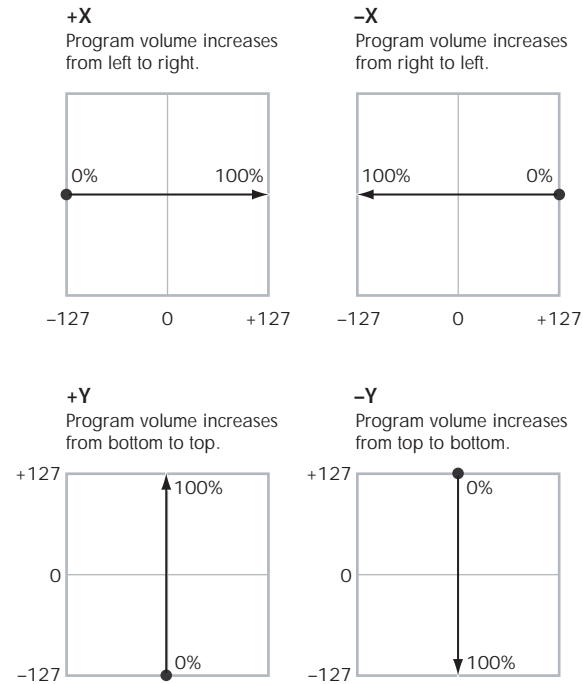

**Center Volume [0, 25, 50, 75, 100%]**

This sets the volume of Timbre 1 at the center point. It applies only when **Equal Amount**, above, is set to **Off**.

The volumes at the extreme ends of the axis are fixed, depending on the setting of the **VJS Assign** parameter.

For instance, if **VJS Assign** is set to **-X**, the Timbre will always be at 100% volume on the left side, and 0% (silent) on the right side.

This parameter applies only to the Combi Vector Volume control, and does not change the Program's individual Vector Volume settings.

*Timbre Center Volume, VJS Assign = -X*

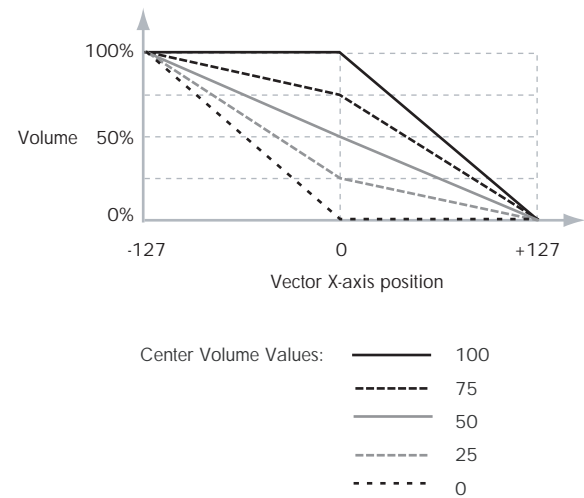

**Enable Program Vector Volume [Off, On]**

When this is turned **On**, the Program's Vector Volume control will function as it does in Program mode, crossfading between Oscillators 1 and 2. The crossfade will be controlled by the combination of the Program's Vector EG and the Vector Joystick, and is not affected by the Combi's Vector EG.

When this is turned **Off**, the Program's Vector Volume control will be disabled.

**Timbres 02-16**

The parameters for Timbres 2-16 are identical to those for Timbre 01, as described above.

**▼ 1-5: Page Menu Commands**

The number before each command shows its ENTER + number-key shortcut. For more information on these shortcuts, see "ENTER + 0-9: shortcuts for menu commands" on page 147.

- 0: **Write Combination**. For more information, see "Write Combination" on page 501.
- 1: **Exclusive Solo**. For more information, see "Exclusive Solo" on page 147.
- 2: **Copy From Program**. For more information, see "Copy From Program" on page 501.



## 1-6: Vector CC Control

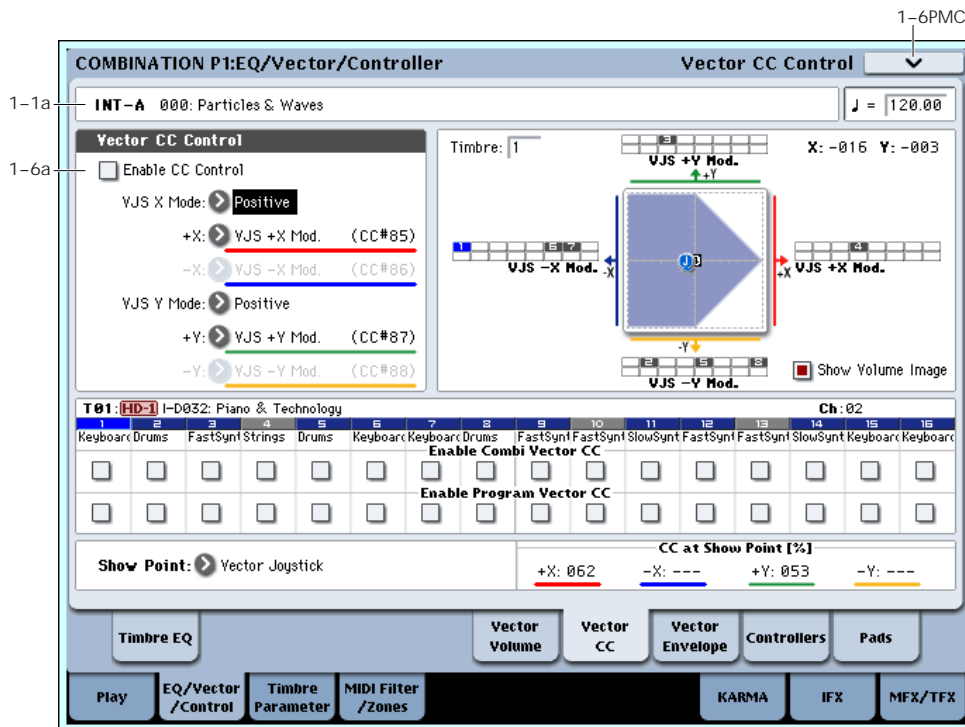

### 1-6a: Vector CC Control

Vector CC Control lets you use the combination of the Vector Joystick and the Vector EG to control the Combi's Effects.

Each of the four directions of the Vector can send a different MIDI CC, including left (-X), right (+X), up (+Y), and down (-Y). You can choose between several different patterns combining these four directions by using the VJS X Mode and VJS Y Mode parameters.

The Vector CCs are also sent to all Global Channel Timbres. These may modulate Program parameters, like any other MIDI CCs, depending on the settings within each individual Program.

Finally, you can optionally send these CCs out to external MIDI instruments. A global parameter allows you to enable or disable this MIDI output; by default, it is disabled.

#### Program and Combi Vectors work together

In Combi mode, each Timbre's Program still has its own Vector EG, which controls volume and CCs as it did in Program mode. You can disable the Program's Vector Volume and CC control separately for each Timbre, if desired.

Program Vector CCs affect only their own Program, even if other Timbres are set to the same MIDI channel.

There is also a separate Combi-wide Vector EG, with its own Vector Volume and CC control settings. Combi Vector CCs affect all Timbres set to the Global channel. As with the Program Vector, you can disable the Combi Volume and CC control separately for each Timbre.

### Vector and MIDI

The Vector features interact with MIDI in two different ways: through the Vector Joystick, and through the Vector CC Control.

The **Vector Joystick** sends and receives two MIDI controllers: one for the X axis, and the other for the Y axis. In Global mode, you can assign these to any MIDI CC numbers you like. The defaults are CC#118 for the X axis, and CC#119 for the Y axis.

The Vector Joystick and its CCs *control* the Vector position, in conjunction with the Vector EG.

The **Vector CC Control**, on the other hand, is *generated by* the Vector position. Normally, this will only affect internal sounds and effects. If you like, however, you can also enable a Global parameter to send these generated CCs to external MIDI devices.

Note that, in Combi mode, only the Combi's Vector CCs can be sent to external MIDI instruments; the individual Program's vector CCs are only used internally.

#### Enable CC Control

[Off, On]

When this box is checked, the Vector position will control the CCs assigned to +X, -X, +Y, and -Y, as set below.

When this box is not checked, the Vector position will not affect these CCs. However, the joystick will still send and receive its dedicated MIDI CCs, just like other physical controllers. See "Vector and MIDI," above, for more information.

This parameter affects only the Combi Vector CCs. Even if this is turned **Off**, the individual Programs' Vector CCs will still function normally.

**VJS X Mode [Positive, Negative, Xfade, Split]**

You can set up the Vector to send out CCs in several different patterns, as shown in the graphic below. This controls the pattern for the X axis.

Note that this setting affects only CC Control; it has no effect on Volume Control. Also, it applies only to the Combi Vector CCs, and has no effect on the individual Program Vector CCs.

**Positive** sends out only +X, starting at 0 at the far left, and increasing to 127 at the far right. -X is disabled in this mode.

**Negative** sends out only -X, starting at 0 at the far right, and increasing to 127 at the far left. In this mode, +X is grayed out.

**Xfade** sends out both +X and -X, overlapping throughout the X axis. As one increases, the other decreases.

**Split** sends out both +X and -X, with a split in the center. +X is sent when the point moves to the right of the center, and -X is sent when the point moves to the left of center.

*Vector CC Modes*

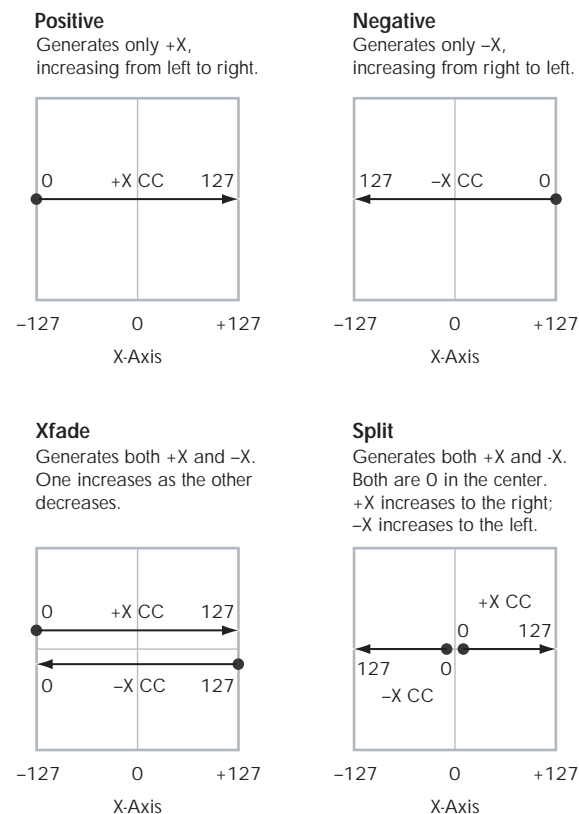

**+X [Off...MIDI CC#119]**

This assigns the controller sent by the +X vector. You can use this as an AMS source to control Program parameters, or as a Dmod source to control Effects parameters. It will be grayed out if the VJS X Mode, above, is set to Negative.

In addition to the standard list of MIDI controllers, you can also assign the +X vector to duplicate the function of several front-panel controllers, including JS X, JS+X, JS-X, Knobs 5–8, and SW 1–2.

For instance, if you assign +X to Knob 6, the vector's +X will use the controller assigned to Knob 6 on the Controller Assign page.

Finally, you can also assign +X to control the Master Volume.

**-X [Off...MIDI CC#119]**

This assigns the controller sent by the -X vector. It will be grayed out if the VJS X Mode, above, is set to Positive.

The selections are the same as for +X, above.

**VJS Y Mode [Positive, Negative, Xfade, Split]**

This controls the Vector CC pattern for the Y axis. For more information, see the description under VJS X Mode, above.

**+Y [Off...MIDI CC#119]**

This assigns the controller sent by the +Y vector. It will be grayed out if the VJS Y Mode, above, is set to Negative.

The selections are the same as for +X, above.

**-Y [Off...MIDI CC#119]**

This assigns the controller sent by the -Y vector. It will be grayed out if the VJS Y Mode, above, is set to Positive.

The selections are the same as for +X, above.

**Show Point [VJS, Vector EG Point 0...4]**

You can view the volume and CC values for the current position of the Vector Joystick, or for any of the EG's five points. This selects the point whose values will be shown.

**CC at Show Point [%]**

This read-only display shows the volume values for the current Vector point, as selected by the Show Point parameter, above.

**Timbre 01**

**Enable Combi Vector CC [Off, On]**

This controls whether or not the Timbre will receive the Combi Vector CCs.

If this is **On**, the Timbre will receive the CCs, and the Timbre's Program will respond to them according to its own AMS settings.

If this is **Off**, the Timbre will not receive the CCs. This can be useful if the Combi's Vector CCs are causing unwanted modulation, or conflicting with the Program's own Vector CCs.

**Enable Program Vector CC [Off, On]**

This controls whether or not the Program's own Vector CCs will be active.

If this is **On**, the Program's Vector CCs and Vector EG will work as AMS sources, just as they did in Program mode. The CCs will not affect any other Timbres, even if they are set to the same MIDI channel.

Note that, in some cases, the Vector CCs may have been used for modulating the Program's effects via Dmod. This functionality is not carried into the Combi; for modulating the Combi effects, use the Combi's Vector CCs instead.

If Enable Program Vector CC is **Off**, then the Program's Vector CCs will have no effect. This can be useful if they are conflicting with the Combi's Vector CCs.

**Timbres 02–16**

The settings for Timbres 2–16 are identical to those for Timbre 01, as described above.

▼ **1–6: Page Menu Commands**

The number before each command shows its ENTER + number-key shortcut. For more information on these shortcuts, see "ENTER + 0-9: shortcuts for menu commands" on page 147.

- **0: Write Combination.** For more information, see "Write Combination" on page 501.
- **1: Exclusive Solo.** For more information, see "Exclusive Solo" on page 147.
- **2: Copy From Program.** For more information, see "Copy From Program" on page 501.

**1–7: Vector Envelope**

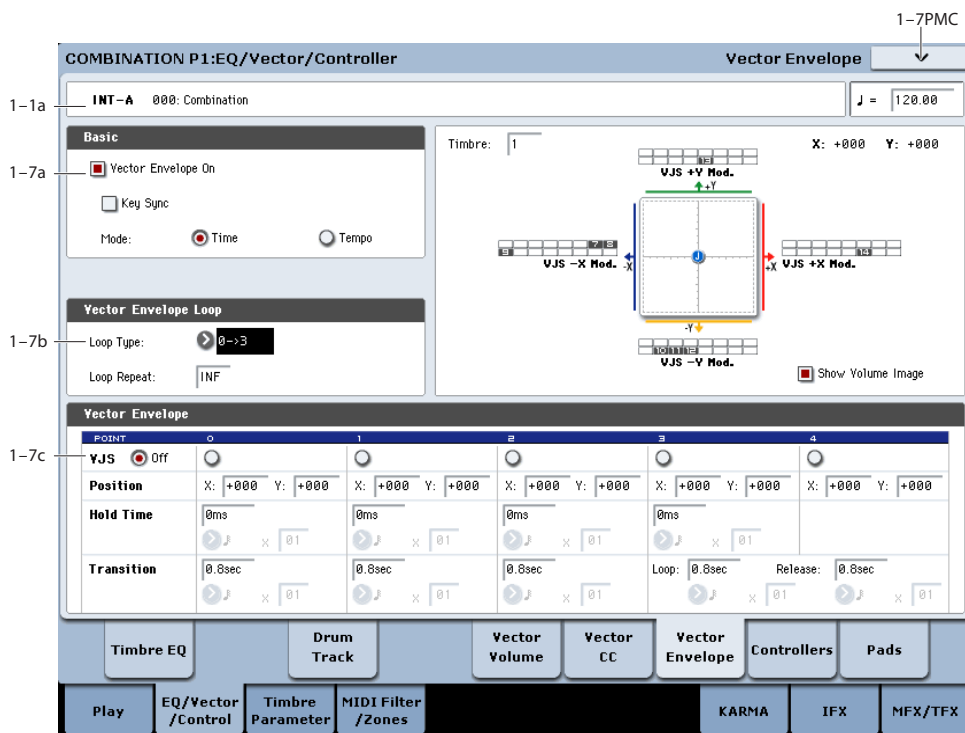

The Vector Envelope works together with the Vector Joystick to control the Vector position. It's particularly convenient for modulating effects, since it's the only Combi-wide programmable modulation source outside of KARMA.

The Vector Envelope is different from the other envelopes in several ways:

- Each point has two "levels" - one for the X axis, and one for the Y axis.
- The envelope times can be based on seconds and milliseconds, or synced to tempo.
- Each point has a hold time, as well as a transition time to the next point.
- The envelope can loop between two points, for either a specified number of repeats, or as long as you hold the note.

**Vector Volume and CC control use separate EGs**

There are actually two different Vector EGs, which share the same parameters: one for Volume Control, and the other for CC Control.

All of the notes on the Combi's Global Channel share a single CC Control EG. This EG starts when you first play a note, and continues as long as any notes are held down on the keyboard. When you release all of the notes, the EG goes into its release phase.

Each note then has its own, additional Volume Control EG, which lets you crossfade between Programs to create complex, evolving timbres. The **Key Sync** parameter applies only to this per-note EG.

When the **Key Sync** parameter is **Off**, the CC Control and Volume Control EGs are completely synchronized.

When **Key Sync** is **On**, each note's Volume Control EG will start at note-on, and go into release at note-off. All the notes will still share a single CC Control EG.

### 1-7a: Basic

#### Vector Envelope On [Off, On]

**On (checked):** When this box is checked, the Vector EG will work with the Vector Joystick to control the vector position.

**Off (unchecked):** When this box is not checked, the Vector EG will not run. The vector position will be controlled solely by the Vector Joystick.

#### Key Sync [Off, On]

The Key Sync parameter applies only to Vector Volume control. As described under "Vector Volume and CC control use separate EGs," above, Vector CC control always acts as if Key Sync were Off.

**On (checked):** When Key Sync is **On**, the Vector Volume EG starts each time you press a key, and an independent EG runs for each note. This is the normal setting.

**Off (unchecked):** When Key Sync is **Off**, the Vector Volume EG starts from the phase determined by the first note in the phrase, so that the EGs for all notes being held are synchronized together.

#### Mode [Time, Tempo]

**Time:** When the Mode is set to **Time**, you can set the EG segment times in seconds or milliseconds.

**Tempo:** When the Mode is set to **Tempo**, the Vector EG will synchronize to the system tempo, as set by either the Tempo knob or MIDI Clock. Instead of using seconds and milliseconds, you can specify the EG times as rhythmic values, using the Base Note and Multiplier parameters.

### 1-7b: Vector Envelope Loop

The Vector EG can loop between two points, and can continue to loop either for as long as you hold the note, or for a specified number of repeats. You can also turn the loop off completely, if you like.

#### Loop Type [0->3, 1->3, 2->3, 0<->3, 1<->3]

This selects the start and end points of the loop, and whether the loop is forwards only or forwards-backwards.

The first three selections, 0->3, 1->3, and 2->3, loop forwards only. For instance, when **Loop Type** is set to 1->3, the EG will play as follows: 0, 1, 2, 3, 1, 2, 3, 1, 2, 3 etc.

The last two selections, 0<->3 and 1<->3, are forwards-backwards. For instance, with the 1<->3 setting, the EG will play as follows: 0, 1, 2, 3, 2, 1, 2, 3 etc.

#### Loop Repeat [Off, 1...126, Inf]

**Off:** When this is set to Off, the EG will not loop at all.

**1-126:** The EG will loop the specified number of times, and then hold at point 3 until the note is released.

**Inf:** The EG will loop as long as the note is held, and then move to point 4 when the note is released.

### 1-7c: Vector Envelope

The Vector EG has a total of five points. Since the Vector EG can loop, the points are labeled differently from standard envelopes; instead of names like attack and decay, they are simply numbered 0-4.

#### Sustain and Release

When the EG is in the middle of a loop, there is no "sustain" point per se. However, if the EG has already completed the specified number of **Loop Repeats**, or if **Loop Repeat** is Off, it will sustain at Point 3 until release.

At release, the EG always moves to Point 4.

#### Hold and Transition times

The Hold Time sets how long the EG lingers at each point, and the Transition time sets how long it takes to go from the selected point to the next.

For instance, the graphic below shows the succession of Hold and Transition times when the Loop Type is set to 1->3. For clarity, only the Y axis positions are shown.

*Vector EG times, Loop Type = 1->3*

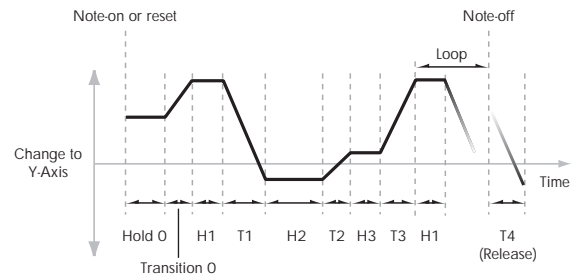

The transition from Point 3 into the loop always uses Point 3's Transition time, regardless of the **Loop Type**.

Points 0, 1, and 2's Transition times, however, work in reverse when moving backwards during a forwards-backwards loop. It's as if you were re-tracing the EG shape in reverse.

For instance, in the backwards section of a loop, moving from Point 2 to Point 1 uses Point 1's Transition time.

*Forwards-Backwards Loop, Loop Type = 1<->3*

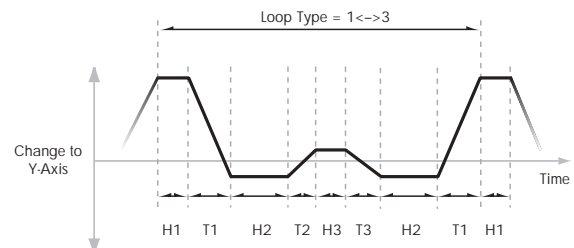

#### VJS [Off, 0...4]

This horizontal row of radio buttons lets you edit the selected point's X-Y position using the Vector Joystick.

Just press the point's radio button, move the Vector Joystick to the desired location. When you're finished, press the Off radio button again.

When you are not editing the EG's X-Y positions, you should leave this set to Off, to avoid inadvertent changes to the EG.

### Point 0

#### Position

In addition to editing the X and Y parameters with the standard data entry controls, you can also simply use the Vector Joystick to set the position, as described under "VJS," above.

**X** [-127...+127]

This sets the point's position on the X axis.

**Y** [-127...+127]

This sets the point's position on the Y axis.

#### Hold Time

This sets the length of time that the EG will stay on Point 0, before moving to Point 1. You can set the Hold Time in either seconds/milliseconds or rhythmic values, depending on the setting of the EG's **Mode** parameter.

**Time** [0ms...60sec]

This parameter lets you set the Hold Time in seconds and milliseconds. It applies only when the **Mode** is set to Time.

**(Base Note)** [Off, ♪... ◦]

This menu sets a basic rhythmic value for the **Hold Time**, relative to the system tempo. The values range from a 32nd note to a whole note, including triplets.

This parameter applies only when the **Mode** is set to **Tempo**.

**x (Multiply Base Note by...)** [01...32]

This multiplies the length of the **Base Note**. For instance, if the **Base Note** is set to a sixteenth note, and the multiplier is set to 3, the **Hold Time** will last for a dotted eighth note.

#### Transition

This sets the length of time that the EG takes to move from Point 0 to Point 1.

When the **Loop Type** is set to 0<->3, this also sets the time that it takes to move from Point 1 to Point 0 during the backwards section of the loop.

**Time** [0ms...60sec]

This parameter lets you set the Transition time in seconds and milliseconds. It applies only when the **Mode** is set to Time.

**(Base Note)** [♪... ◦]

This menu sets a basic rhythmic value for the Transition time, relative to the system tempo. It applies only when the **Mode** is set to **Tempo**.

**x (Multiply Base Note by...)** [01...32]

This multiplies the length of the **Base Note**. For instance, if the **Base Note** is set to a sixteenth note, and the multiplier is set to 3, the EG will move from Point 0 to Point 1 over a dotted eighth note.

### Points 1 and 2

Points 1 and 2 work exactly like Point 0, as described above.

### Point 3

Point 3 also works much like Points 0-2, with two main differences:

Point 3 always uses its own **Time** when moving into the loop, regardless of the direction of the loop.

If the **Loop Repeats** is set to Off, or if the **Loop** is set to 1-126 and has already played the specified number of times, then the EG will stay at Point 3 until the EG either goes into release, or is reset by KARMA.

#### Hold Time

This works just like the **Hold Time** for Point 0, as described under "Hold Time" on page 450.

#### Loop

This sets the length of time that it takes to move from Point 3 to the first Point in the loop. You can set this in either seconds/milliseconds or rhythmic values, depending on whether the **Mode** is set to Time or Tempo.

The **Time**, **Base Note**, and **Multiplier** parameters work just like those for Point 0, as described under "Transition" on page 450.

### Point 4

Point 4 is the Vector EG's release destination. Its time setting is different from those of the other Points. Instead of setting the time it takes to move from Point 4 to the next Point, it sets how long it takes to go from the previous Point to Point 4.

The EG moves to Point 4 as soon as it releases, regardless of where it was before the release. For instance, let's say that the EG is in the middle of Point 2's Hold Time at note-off. The EG will immediately begin to move to Point 4, without waiting for the Hold Time to complete.

#### Release

This sets the length of time that it takes to move to Point 4 after note-off. You can set this in either seconds/milliseconds or rhythmic values, depending on whether the **Mode** is set to Time or Tempo.

The **Time**, **Base Note**, and **Multiplier** parameters work just like those for Point 0, as described under "Transition" on page 450.

### KARMA and Vector EG interaction

KARMA can start and re-start the Vector EG in various ways, as described below:

#### CC Control EG

When KARMA is **On**, it always starts and re-starts the CC Control EG, according to the KARMA trigger settings. This lets KARMA control sounds or effects in synchronization with the KARMA GE.

### Volume Control EGs

When **Key Sync** is **Off**, and **KARMA** is **On**, KARMA will start and re-start the Volume Control EGs as well as the CC Control EG. This means that the resulting changes in oscillator volumes will be synchronized with the KARMA GE.

When **Key Sync** is **On**, KARMA does not affect Vector Volume Control. Each note will have its own, independent Volume Control EG, just as if KARMA was turned off.

### Entering the EG's release stage

Assuming that KARMA is **On**:

When the **KARMA LATCH** switch is **Off**, the KARMA-controlled Vector EG(s) will start to release when you remove your hand from the keyboard (and when KARMA is no longer receiving any input notes from other sources).

When the **KARMA LATCH** switch is **On**, the KARMA-controlled Vector EG(s) will start to release only when **KARMA Latch** is turned **Off** again.

### ▼ 1-7: Page Menu Commands

The number before each command shows its ENTER + number-key shortcut. For more information on these shortcuts, see "ENTER + 0-9: shortcuts for menu commands" on page 147.

- 0: **Write Combination**. For more information, see "Write Combination" on page 501.
- 1: **Exclusive Solo**. For more information, see "Exclusive Solo" on page 147.
- 2: **Copy From Program**. For more information, see "Copy From Program" on page 501.
- 3: **Copy Vector Envelope**. For more information, see "Copy Vector Envelope" on page 153.

## 1-8: Set Up Controllers

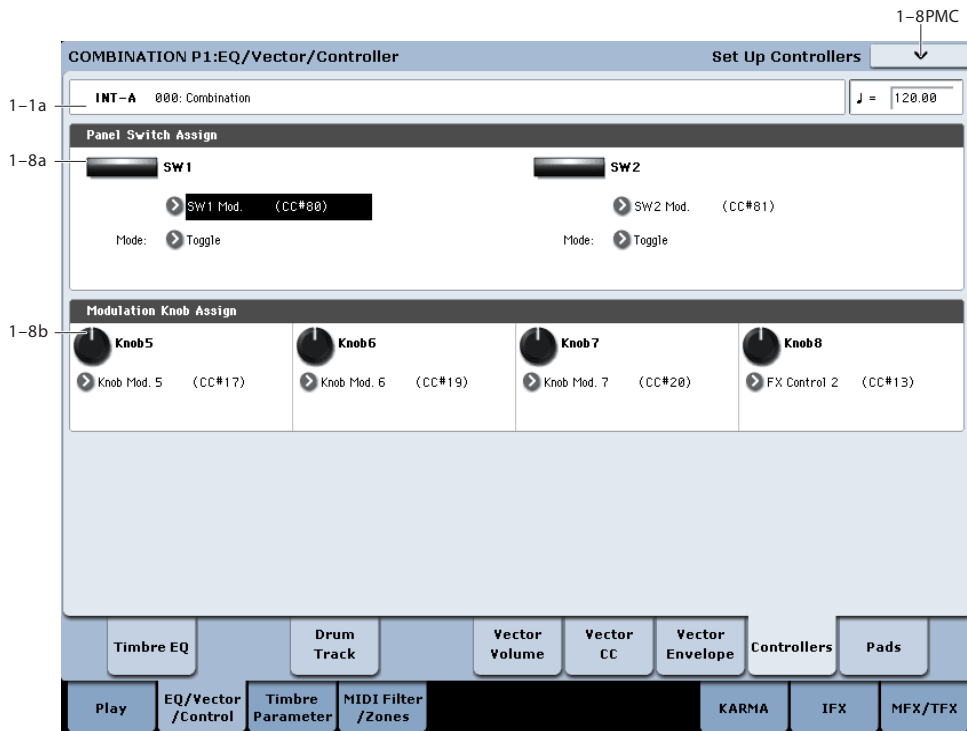

Here you can set the Combination functions of the SW1 switch, SW2 switch, and the Realtime Modulation Knob 5-8. These settings are made independently for each combination.

### 1-8a: Panel Switch Assign

Here you can assign the function of the SW1 and SW2 switches. For details on the functions that can be assigned, see "SW1/2 Assignments" on page 1104.

#### SW1 [Off, ..., After Touch Lock]

Assigns a function to the SW1 switch. The on/off status can also be saved. When you change the assigned function, the status will be reset to off.

#### Mode [Toggle, Momentary]

Specifies the on/off action that occurs when you press the SW1 switch.

**Toggle:** The function will alternate between on and off each time you press the SW1 switch.

**Momentary:** The function will be on only while you continue holding down the SW1 switch.

#### SW2 [Off, ..., After Touch Lock]

#### Mode [Toggle, Momentary]

Assigns a function to the SW2 switch. The functions you can assign to the SW2 switch are the same as for the SW1 switch with the exception that SW1 Mod.:CC#80 is replaced by SW2 Mod.:CC#81.



### 1–8b: Realtime Modulation Knob Assign

Here you can assign the function of the realtime modulation knobs 5 through 8. Most of the functions that can be assigned are control changes. For more information, please see “Realtime Knobs 5–8 Assignments” on page 1105.

The functions you assign here are performed when you operate realtime modulation knobs 5 through 8.

- Knob 5** [Off, ..., MIDI CC#119]
- Knob 6** [Off, ..., MIDI CC#119]
- Knob 7** [Off, ..., MIDI CC#119]
- Knob 8** [Off, ..., MIDI CC#119]

### ▼ 1–8: Page Menu Commands

The number before each command shows its ENTER + number-key shortcut. For more information on these shortcuts, see “ENTER + 0-9: shortcuts for menu commands” on page 147.

- **0: Write Combination.** For more information, see “Write Combination” on page 501.
- **1: Exclusive Solo.** For more information, see “Exclusive Solo” on page 147.
- **2: Copy From Program.** For more information, see “Copy From Program” on page 501.

## 1–9: Pads

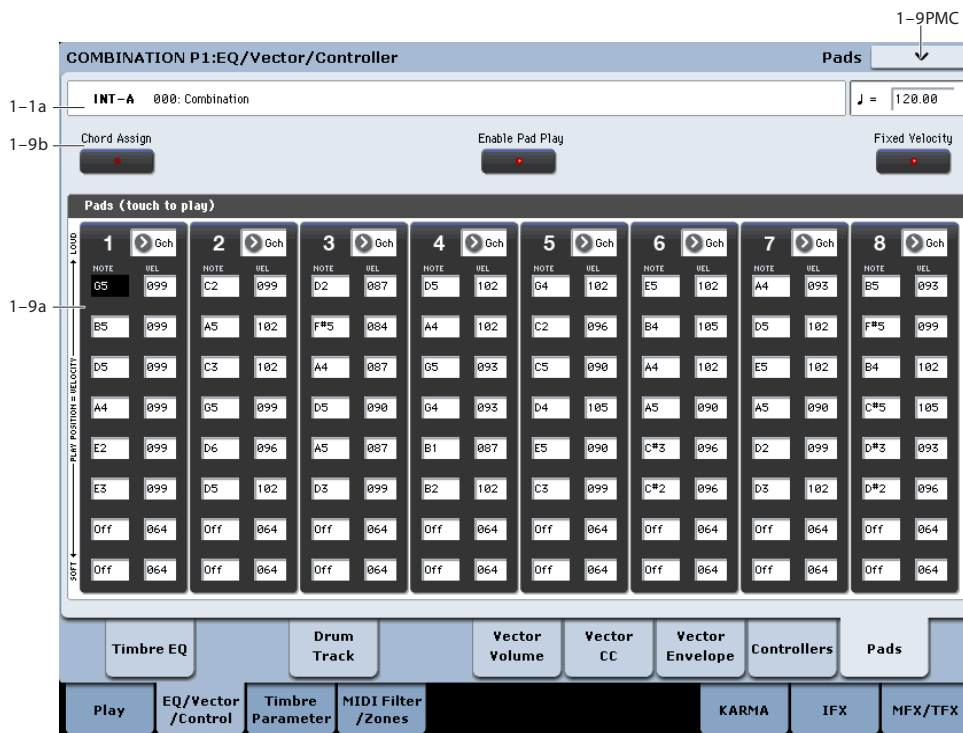

 To avoid damaging the display, use care when playing the pads. Do not press strongly on the display or strike forcefully; instead, use a light and precise touch. “Velocity” is controlled by position, and not by force.

This page features 8 touch-controlled virtual “pads,” which you can use for:

- Storing and selecting chords for Chord mode
- Selecting and triggering chords, especially for use with KARMA
- Playing drum sounds, especially in conjunction with a compatible USB MIDI pad device

The pads can play up to eight-note chords—and they even remember the velocities of the individual notes within the chord. Each Pad can also be assigned to a different MIDI channel, if desired. These settings are stored independently for each Combination.

You can play the pads in several different ways:

- By playing directly on the screen
- Via a pad-equipped Korg USB MIDI controller
- Via incoming MIDI notes or CCs, or the same from the local keyboard

For more information, see “Playing the pads” on page 54.



For general information on the pads, including step-by-step instructions and usage tips, see “Using the Chord Pads” on page 35 of the Operation Guide.

In addition to playing sounds directly, the pads are also used to select chords for Chord mode. For more information, see “Using Chord mode” on page 36 of the Operation Guide.

### 1-9a: Pad Chords

#### Pad 1

##### MIDI Channel [Ch01...Ch16, Gch]

This sets the pad’s MIDI output channel. You can set this to either a specific channel (1-16), or the Global MIDI Channel.

**Ch01...Ch16:** The pad will transmit on the selected MIDI channel. As shown in the diagram “Pads and MIDI Channel,” below, you can:

- Use this in conjunction with the **Timbre MIDI Channel** setting, to route a pad to a specific Timbre. For more information, see “MIDI Channel” on page 454.
- Use this with the KARMA Module **Input Channel** setting, to generate a phrase or other KARMA function when you play a specific pad. For more information, see “Input Channel” on page 471.

**Gch:** Use the global **MIDI Channel** setting. This is the default. For more information, see “MIDI Channel (Global MIDI Channel)” on page 770.

#### Pads and MIDI Channel

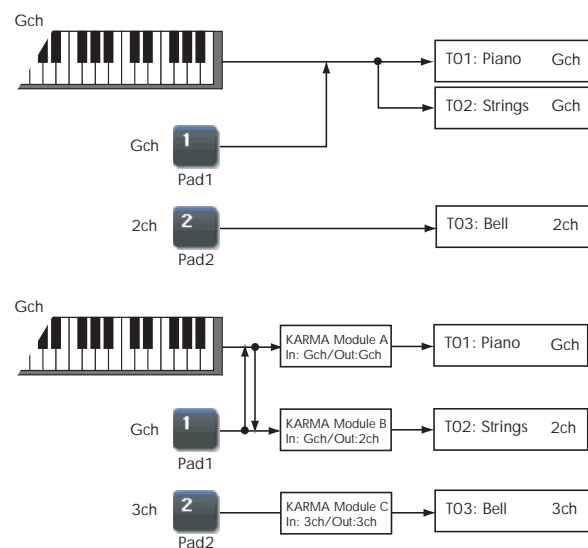

##### Notes 1-8 [Off, C-1...G9 / 001...127]

These parameters let you edit the 8 notes assigned to each pad, along with a separate velocity for each note. To play fewer than 8 notes, just set the unwanted notes to **Off**.

**Off:** Select this to disable the note.

**C-1...G9:** This sets the note number.

**001...127:** This sets the note’s velocity value. For more information on pads and velocity, please see “Fixed Velocity” on page 55.

You can assign notes to the pads directly from the keyboard, or enter notes and velocities manually. You can also copy all notes from one pad to another. Regardless of how the notes were first assigned, you can edit their values here.

For detailed instructions on assigning notes and copying pads, please see “Using the Chord Pads” on page 35 of the Operation Guide.

#### Pads 2...8

These are the same as for Pad 1, as described above.

### 1-9b: Control buttons

**Chord Assign** [Off, On]

**Enable Pad Play** [Off, On]

**Fixed Velocity** [Off, On]

These buttons work the same as in Program mode. For detailed information, please see “1-9b: Control buttons” on page 55.

### ▼ 1-9: Page Menu Commands

The number before each command shows its ENTER + number-key shortcut. For more information on these shortcuts, see “ENTER + 0-9: shortcuts for menu commands” on page 147.

- **0: Write Combination.** For more information, see “Write Combination” on page 501.
- **1: Exclusive Solo.** For more information, see “Exclusive Solo” on page 147.
- **2: Copy From Program.** For more information, see “Copy From Program” on page 501.
- **3: Copy Pad Setup.** For more information, see “Copy Pad Setup” on page 154.

## Combination P2: Timbre Parameters

### 2-1: MIDI

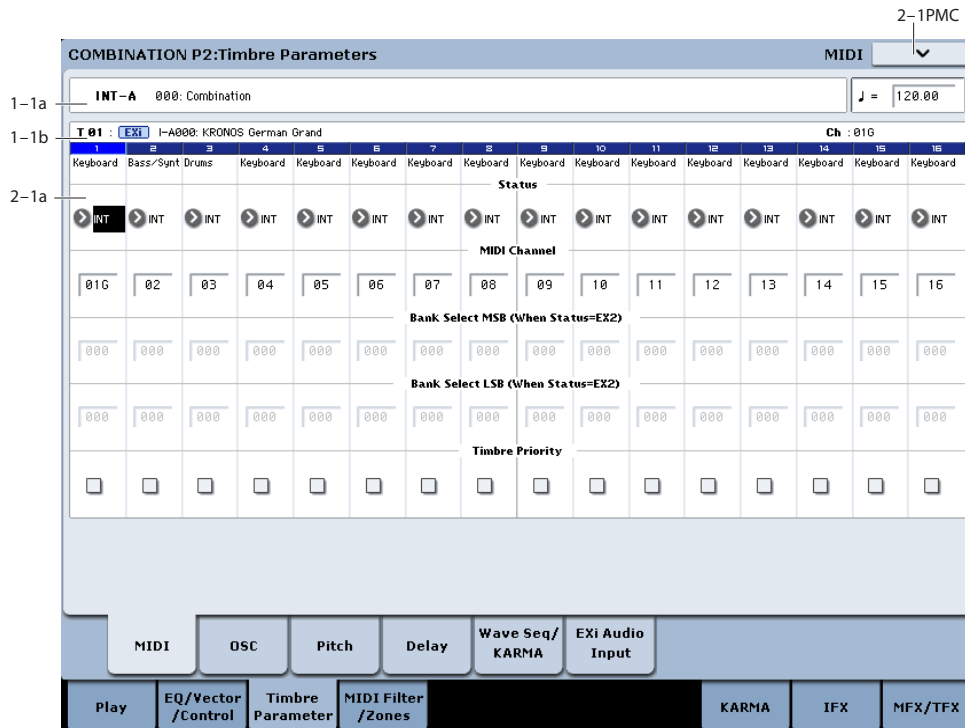

Here you can make MIDI settings for each Timbre.

#### 2-1a: MIDI

##### Timbre 01

**Status** [Off, INT, EXT, EX2]

This specifies the MIDI and internal tone generator status.

You can also set **Status** from the P0- Program Select page. For more information, please see "Status" on page 419.

**MIDI Channel** [01...16, Gch]

Sets the MIDI transmit/receive channel for each timbre.

**Gch:** The timbre will use the channel that has been selected as the global **MIDI Channel** (Global 1-1a).

When **Status** is INT, MIDI messages will be received on the channel you specify here. If this setting is the same as the global MIDI channel, the internal tone generator will sound according to the internal settings. If this is set to EXT or EX2, playing the KRONOS will transmit MIDI messages on the MIDI channel specified here. (Messages will also be transmitted simultaneously on the global MIDI channel.)

**Bank Select MSB (When Status = EX2)** [000...127]

**Bank Select LSB (When Status = EX2)** [000...127]

Specifies the bank number that will be transmitted when **Status** is set to EX2. This setting has no effect if **Status** is other than EX2.

**Timbre Priority** [Off, On]

This lets you protect a Timbre's voices from being stolen by other, non-priority Timbres.

If a new note-on would exceed the available number of voices, one or more currently-sounding voice will be stopped ("stolen") to make room for the new voice. If **Timbre Priority** is **On**, then the Timbre's voices can only be stolen by other priority voices; all voices with **Timbre Priority Off** will be stolen first.

In a Combi with many active Timbres, you can enable **Timbre Priority** for sounds with an important musical role, such as drums or bass. In general, you can enable it for any Timbre for which note stealing would adversely affect the overall sound.

**Important:** this setting will have little meaning if it is turned on for more than a few timbres. It's a good idea to start with **Timbre Priority** un-checked for all Timbres, and only turn it on as necessary.

**On (checked):** The Timbre's voices will be given priority in voice-stealing.

**Off (un-checked):** The Timbre's voices will not be given priority in voice-stealing.

##### Timbres 02... 16

These are the MIDI-related settings for timbres 2 through 16. They are the same as for timbre 1. See "Timbre 01".

▼ 2-1: Page Menu Commands

The number before each command shows its ENTER + number-key shortcut. For more information on these shortcuts, see “ENTER + 0-9: shortcuts for menu commands” on page 147.

- 0: **Write Combination.** For more information, see “Write Combination” on page 501.
- 1: **Exclusive Solo.** For more information, see “Exclusive Solo” on page 147.
- 2: **Copy From Program.** For more information, see “Copy From Program” on page 501.

2-2: OSC

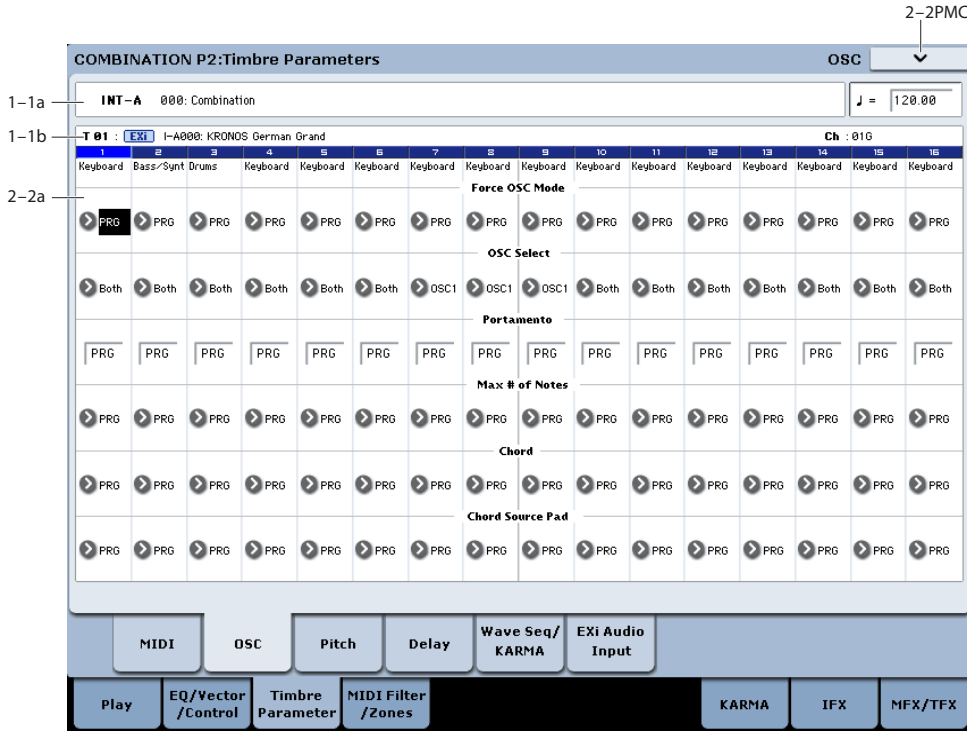

These settings specify how each Timbre will be played.

2-2a: OSC

**Timbre 01**

**Force OSC Mode [PRG, Poly, MN, LGT]**

This lets you override the Program’s stored Voice Assign Mode settings, if desired.

**PRG:** The Program’s stored **Voice Assign Mode** settings will be used. HD-1 programs will use the “1-1c: Voice Assign Mode” settings, and EXi programs will use the “EXi Common 4-1c” settings.

**Poly:** The timbre will play polyphonically, regardless of the Program’s settings.

**MN (Mono):** The timbre will play monophonically, regardless of the Program’s settings.

**LGT (Legato):** The timbre program will sound monophonically, and will play legato according to the Program’s **Mode** setting (Program 1-1b).

With the MN or LGT settings, the Program’s **Priority** setting (Program 1-1c) will determine the priority of the note that sounds when you play two or more notes.

⚠ EXi programs will ignore this setting if the program does not support the Voice Assign Mode specified by the selected Instrument Type.

AL-1: Poly, MN, and LGT are supported.

CX-3: Poly and MN are supported (LGT will operate as MN)

⚠ If different Instrument Types are selected for EXi1 and 2, MN (Mono) and LGT (Legato) settings will be valid only if the type is supported by both.

**OSC Select [BTH, OS1, OS2]**

Specifies whether the timbre’s program will play OSC1 (EXi1), OSC2 (EXi2), or both.

For HD-1 programs whose **Oscillator Mode** (Program 1-1b) is Double, this setting lets you specify that only OSC1 or OSC2 will sound. For EXi programs in which EXi1 and EXi2 are not turned off in the Instrument Type (EXi Common 4-1), this setting lets you specify that only EXi1 or EXi2 will sound.

**BTH (Both):** OSC1 and 2 (or EXi1, 2) will sound as specified by the settings of the program.

**OS1:** Only OSC1 (EXi1) will sound.

**OS2:** Only OSC2 (EXi2) will sound. HD-1 programs will not sound if **Oscillator Mode** is set to Single or Drums. EXi programs will not sound if EXi2 is turned Off in the Instrument Type.

### Portamento [PRG, Off, 001...127]

This controls the Timbre's portamento.

**PRG:** Portamento will be applied as specified by the Program settings.

**Off:** Portamento will be off, even if the original Program settings specified for it to be on.

**001...127:** Portamento will be applied with the portamento time you specify here, even if it is turned off by the program settings.

 Note: not all EXi support portamento, as detailed below; if they do not, then this parameter will be ignored.

AL-1, STR-1, MS-20EX, and MOD-7: portamento is supported

CX-3, PolysixEX, SGX-1, EP-1: portamento is *not* supported

 This parameter can be controlled via MIDI CCs #05 and #65 (portamento time and on/off switch, respectively), subject to two conditions:

First, the Timbre's **Status** must be set to **INT**. For more information, see "Status" on page 419.

Second, if **Portamento** is set to **PRG**, only CC#65 (on/off switch) will apply. CC#05 will be ignored.

### Max # of Notes [Dynamic, 1...16]

**Dynamic** is the default. With this setting, you can play as many notes as the system allows.

**1-16** lets you limit the maximum number of notes played by the Timbre. Voices will still be allocated dynamically, up to this maximum number. You can use this to:

- Model the voice-leading of vintage synthesizers, such as the Polysix
- Control the resources required by the Timbre, so that more voices can play on other Timbres

**Max # of Notes** applies only when the Program's **Voice Assign Mode** is set to **Poly**, or when **Force Osc Mode** has been set to **Poly**. With **Mono**, it has no effect.

This setting does not limit the **Unison Number of Voices**. For instance, if **Max # of Notes** is set to **6**, and **Unison Number of Voices** is set to **3**, you can play up to 6 notes, each with 3 Unison voices.

In double Programs, the **Max # of Notes** applies equally to both OSC or EXi. For instance, if **Max # of Notes** is set to **4**, you can play up to 4 notes on each OSC/EXi.

## Chord

### Chord [PRG, Off, Bsc, Adv]

**PRG** uses the Program's setting. If the Program is set to **Off**, then the Chord SW has no effect.

**Off** disables the Chord function.

**Bsc** (Basic) re-creates the chord mode of the original Polysix. Each time you play a new chord, it will cut off the previous chord. This option ignores the Voice Assign settings.

**Adv** (Advanced) uses the Program's Voice Assign settings, as if each note in the chord was a transposed set of oscillators layered within the Program.

**Poly**, **Poly Legato**, **Single Trigger**, **Mono**, **Mono Legato**, **Legato Offset**, **Mono Priority**, and **Mono and Poly Unison** all apply.

You can achieve the same effect as **Bsc**, above, by setting **Chord** to **Advanced**, **Voice Assign** to **Mono**, **Priority** to **Last Note**, and **Legato** to **Off**.

For more information, see "Using Chord mode" on page 36 of the Operation Guide.

### Source Pad [PRG, 1...8]

Chord mode uses the chords assigned to the on-screen pads. This selects which of the pads to use. You can also select chords using the pads themselves; for more information, see "Using Chord mode" on page 36 of the Operation Guide.

**PRG** uses the notes of the chord stored in the Timbre's Program, instead of any of the chords in the Combi. This makes it easy to use Chord mode for sound-specific effects, such as octaves, stacked fifths, and so on. When set to **PRG**, the Timbre will not change chords in response to the pads.

### Timbres 02...16

Here you can make voice assignment settings for timbres 2 through 16. The settings are the same as for timbre 1. See "Timbre 01".

---

## ▼ 2-2: Page Menu Commands

The number before each command shows its ENTER + number-key shortcut. For more information on these shortcuts, see "ENTER + 0-9: shortcuts for menu commands" on page 147.

- **0: Write Combination.** For more information, see "Write Combination" on page 501.
- **1: Exclusive Solo.** For more information, see "Exclusive Solo" on page 147.
- **2: Copy From Program.** For more information, see "Copy From Program" on page 501.

## 2-3: Pitch

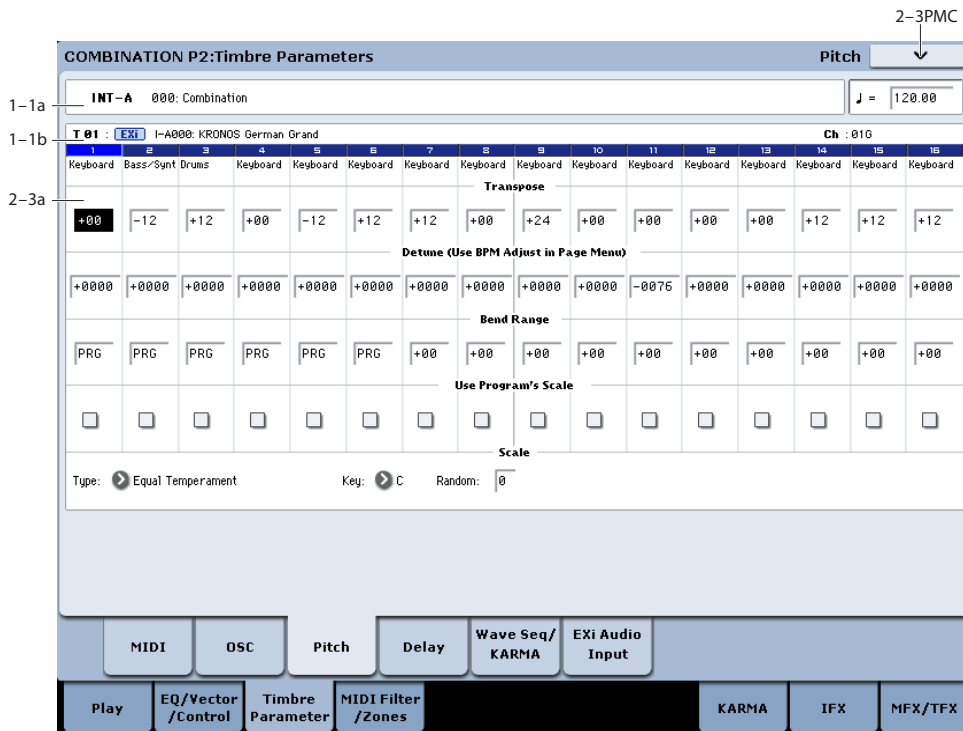

Here you can make pitch-related settings for each timbre.

### 2-3a: Pitch

#### Timbre 01

#### Transpose [-60...+00...+60]

Adjusts the pitch of each timbre in semitone steps.

12 units equal one octave.

**MIDI** When **Status** (0-1b, 2-1a) is INT, this parameter will affect the pitches sounded by the KRONOS. When **Status** is EXT, this parameter will affect the note numbers of the MIDI note messages that are transmitted.

For example if you make settings of +04 and +07 respectively for two timbres that are set to EXT, playing the C key will transmit a C note number on the global MIDI channel, and at the same time will also transmit E and G note numbers on the MIDI channels of those timbres.

#### Detune (Use BPM Adj. in Page Menu) [-1200...+0000...+1200]

Adjusts the pitch of each timbre in one-cent units.

+0000: Normal pitch.

*Note:* You can also use the **Detune BPM Adjust** menu command to alter a loop's tempo via detuning. Since this will alter the pitch of the loop along with the tempo, it's generally suited only to un-pitched percussive loops. For more information, see "Detune BPM Adjust" on page 504.

**MIDI** **Transpose** and **Detune** can be controlled via MIDI RPN messages. The way that this works depends on whether or not the Timbre uses an HD-1 Drum Program.

If the Timbre does not use an HD-1 Drum Program—for example, if it uses a Single or Double HD-1 Program, or an EXi Program—then MIDI RPN Coarse Tune will control **Transpose**, and RPN Fine Tune will control **Detune**.

If the Timbre uses an HD-1 Drum Program, MIDI RPN Coarse Tune and Fine Tune will be combined to control **Detune**. The overall range is ±1 octave for coarse tune and fine tune together.

#### Bend Range [PRG, -24...+00...+24]

Specifies the amount of pitch change that will occur when the pitch bender is operated, in semitones.

**PRG:** The pitch range specified by the program will be used.

-24...+24: This setting will be used regardless of the setting in the program.

**MIDI** The MIDI RPN Pitch Bend Change message can be received to control this and change the setting. (However it will not be received if this parameter is set to PRG.) This message is received on the MIDI channel for each timbre set by **MIDI Channel** (2-1a). (See KARMA "Transmit MIDI Filter," "Pitch Bend" 7-2a)

#### Use Program's Scale [Off, On]

Timbre can use the scale that is specified by *Scale* (Program 1-1c).

**On (checked):** The scale specified by the program will be used.

## Combination mode

**Off (unchecked):** The scale specified by Scale (2–3b) will be used.

### Timbres 02...16

These are the pitch-related settings for timbres 2 through 16. The settings are the same as for timbre 1. For more information, see “Timbre 01”.

### 2–3b: Combination’s Scale

This specifies the scale that the combination will use. For more information, please see “1–1g: Scale” on page 41.

#### Type (Combi’s Scale) [Equal Temperament...User Octave Scale15]

Selects the scale.

#### Key [C...B]

Selects the tonic key of the selected scale.

### Random [0...7]

As this value is increased, an increasingly random deviation will be added to the pitch at each note-on.

## ▼ 2–3: Page Menu Commands

The number before each command shows its ENTER + number-key shortcut. For more information on these shortcuts, see “ENTER + 0-9: shortcuts for menu commands” on page 147.

- **0: Write Combination.** For more information, see “Write Combination” on page 501.
- **1: Exclusive Solo.** For more information, see “Exclusive Solo” on page 147.
- **2: Copy From Program.** For more information, see “Copy From Program” on page 501.
- **3: Detune BPM Adjust.** For more information, see “Detune BPM Adjust” on page 504.

## 2–4: Delay

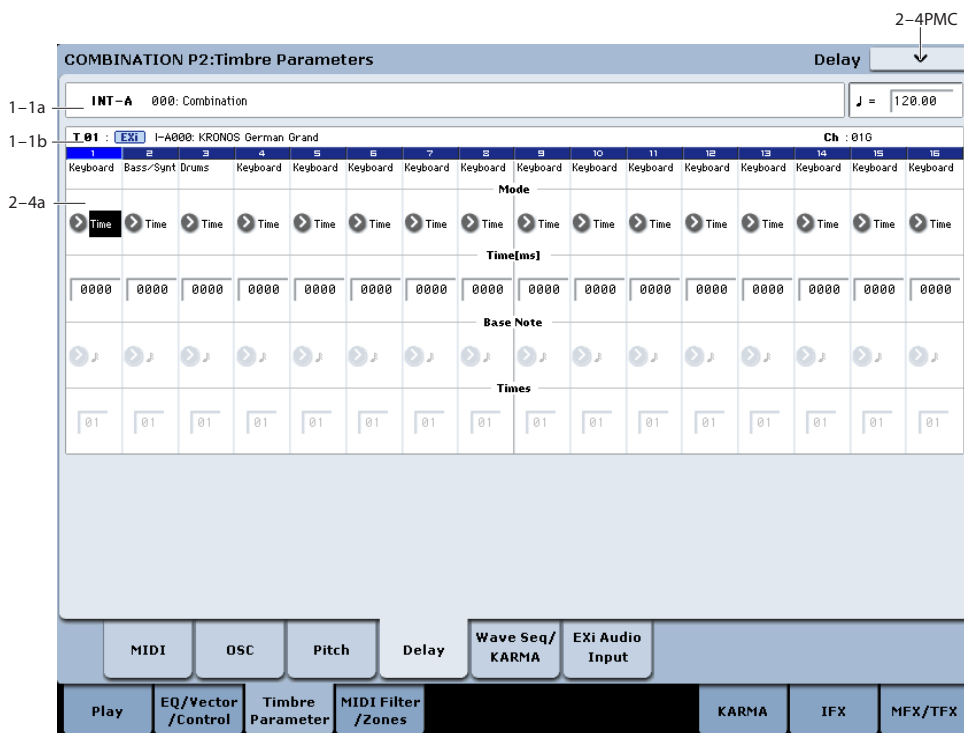

This specifies the time (delay) from when the timbre receives a note-on until the sound begins.

### 2–4a: Delay

#### Timbre 01

#### Mode [Time, Tempo]

Chooses the unit in which you will specify delay time.

**Time:** Specify the delay time in units of milliseconds (ms = 1/1000th of a second).

**Tempo:** Specify the delay time in terms of a **Base Note** and **Times** relative to the **Tempo**. For example if **Base Note** = ♩, **Times** = 01, and **Tempo** = 60 BPM, the delay time will be equivalent to 1000 ms.

#### Time [ms] [0000...6000ms, KeyOff]

Specifies the delay time from note-on until the Timbre begins to produce sound, in units of ms (1/1000th of a second). This setting is available if **Mode** is set to Time. The default is 0000.

**KeyOff:** The note will begin sounding at note-off. In this case, the sound will not die away if the sustain level of the program’s amp EG is other than 0. This setting is used when creating harpsichord sounds.



**Base Note** [♪...o]

**Times** [01...32]

This setting is available when **Mode** is set to **Tempo**. It specifies the delay time from note-on until the timbre begins to produce sound, in terms of a note value relative to the **Tempo** (♪) (0-1a).

Use **Base Note** to specify the desired note value, and use **Times** to extend that note value by the specified multiple.

For example, if you set **Base Note** to a quarter note (♪) and **Times** to 02, the timbre will sound with a delay of a half note (♪)—even if you change **Tempo** (♪). In this case, a **Tempo** of 60.00 BPM will produce a 2000 ms delay, and a **Tempo** of 120.00 BPM will produce a 1000 ms delay.

**Timbres 02...16**

These are the delay time settings for Timbres 2 through 16. They are the same as for Timbre 1, as described above.

▼ **2-4: Page Menu Commands**

The number before each command shows its ENTER + number-key shortcut. For more information on these shortcuts, see “ENTER + 0-9: shortcuts for menu commands” on page 147.

- **0: Write Combination.** For more information, see “Write Combination” on page 501.
- **1: Exclusive Solo.** For more information, see “Exclusive Solo” on page 147.
- **2: Copy From Program.** For more information, see “Copy From Program” on page 501.

**2-5: Wave Sequence/KARMA**

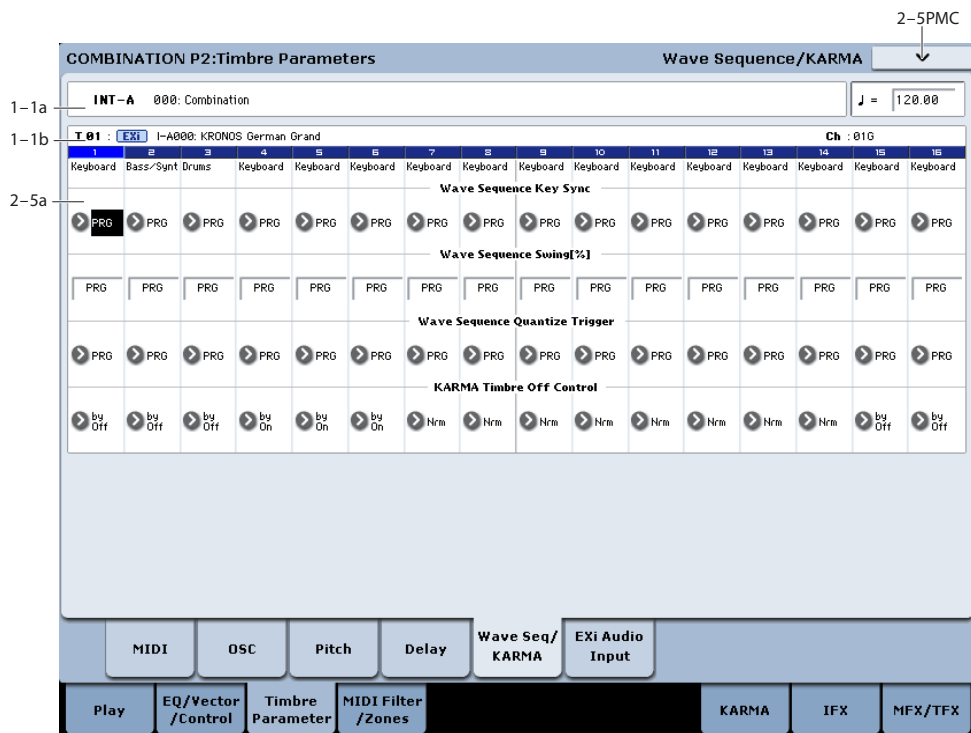

Here you can make settings related to wave sequence and KARMA functionality for each timbre.

**2-5a: Wave Sequence/KARMA**

**Timbre 01**

**Wave Sequence Key Sync** [PRG, Off, On]

Specifies the wave sequence **Key Sync** setting (Program 1-1e) of the program selected for the timbre. This setting is valid if the program uses a wave sequence.

**PRG:** The setting of the program is used.

**Off: Key Sync** is forced off. The wave sequence of each note will synchronize to the same step.

**On: Key Sync** is forced on. The wave sequence will start each time you press a key. If the wave sequences have differing steps or rates, they will proceed independently.

**Wave Sequence Swing[%]** [PRG, -300...+300]

Specifies the wave sequence “Swing%” setting (Program 1-1e) of the program selected for the timbre. This setting is valid if the program uses a wave sequence.

**PRG:** The setting of the program is used.

**-300...+300:** The Swing% specified here is used regardless of the program’s “Swing” setting.

For more information, please see “Swing” on page 39.



### Wave Sequence Quantize Trigger [PRG, Off, On]

This allows you to override the Program's Wave Sequence "Quantize Trigger" setting (Program 1-1d). If you're using multiple Programs with rhythmic Wave Sequences, you can use this to synchronize all of the Wave Sequences at note-on.

Note that Quantize Trigger applies only when the Wave Sequence's **Mode** is set to Tempo. For more information, see "Mode" on page 788.

**PRG:** The setting of the program is used.

**Off:** "Quantize Trigger" is forced off. The wave sequence will trigger immediately after note-on.

**On:** "Quantize Trigger" is forced on. The wave sequence pattern will synchronize to eighth-note timing of the currently-sounding wave sequence; i.e., the trigger will be quantized.

For more information, please see "Quantize Trigger" on page 40.

### KARMA Timbre Off Control

[Normal, Timbre Off by KARMA Off, Timbre Off by KARMA On]

**Nrm (Normal):** The KARMA ON/OFF switch will not control whether a timbre will sound. Normally you will select Normal.

**by Off (Timbre Off by KARMA Off):** The timbre will sound as usual when the KARMA ON/OFF switch is on.

The timbre will not sound when the KARMA ON/OFF switch is off.

Use this when you want a specific timbre of multiple timbres set to the same MIDI channel to be silent only when KARMA is off.

**by On (Timbre Off by KARMA On):** The timbre will not sound when the KARMA ON/OFF switch is on. The timbre will sound as usual when the KARMA ON/OFF switch is off.

Use this when you are using a KARMA Module to control multiple timbres that are set to the same MIDI channel, and want a specific timbre to be silent only when KARMA is on.

For example you can use this to play a two-timbre layer from the keyboard when KARMA is off, and use one timbre to sound the phrase when KARMA is on.

If the **Status** (0-1b) of each timbre is INT, you can use the **Timbre Off Control** setting to stop the oscillator of each timbre from sounding.

### Timbres 02...16

These are the wave sequence and KARMA-related settings for timbres 2 through 16. They are the same as for timbre 1. See "Timbre 01".

- **1: Exclusive Solo.** For more information, see "Exclusive Solo" on page 147.
- **2: Copy From Program.** For more information, see "Copy From Program" on page 501.

---

## ▼ 2-5: Page Menu Commands

The number before each command shows its ENTER + number-key shortcut. For more information on these shortcuts, see "ENTER + 0-9: shortcuts for menu commands" on page 147.

- **0: Write Combination.** For more information, see "Write Combination" on page 501.

## 2-6: EXi Audio Input

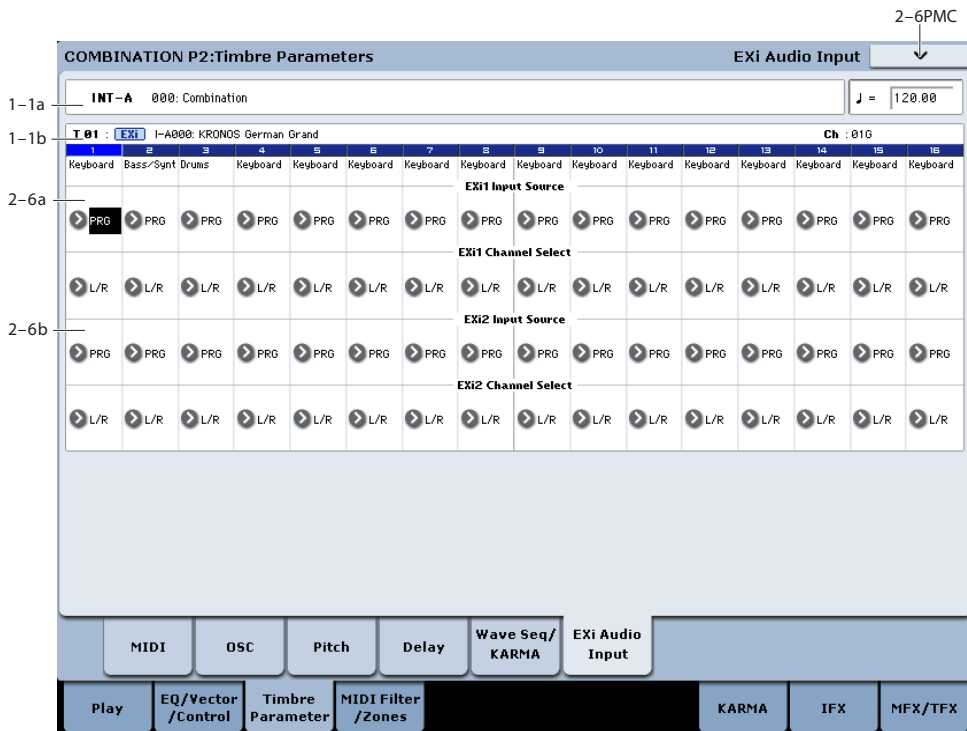

These parameters let you route audio into EXi instruments which support audio input, including the STR-1, MS-20EX, and MOD-7. You can use this to create feedback loops, or to process live or recorded audio through the EXi's synthesis engine.

EXi which do not support audio input will ignore these settings. The AL-1 supports audio input, but uses its own dedicated routing which is not affected by these parameters.

For more information on using audio inputs with EXi, see:

AL-1: "4-3c: Sub OSC/Audio Input" on page 191

STR-1: "4-8c: Feedback" on page 271

MS-20EX: "6-1k: EXTERNAL SIGNAL PROCESSOR (ESP)" on page 313

MOD-7: "5-1f: EXi Audio Input" on page 359

### 2-6a: EXi 1

**Input Source** [PRG, Off, Audio Input 1/2, USB 1/2, S/P DIF Input L/R, L/R Output, Indiv. Output 1/2...3/4, REC 1/2...3/4, FX Control 1, 2, IFX 1...12, MFX 1, 2, TFX 1, 2]

This selects the input source for EXi1. You can use this to create a feedback loop, if desired.

**PRG** uses the setting stored in the Program. For more information, see "4-2: EXi Audio Input" on page 174.

**Off** disables the input.

**Audio Input 1/2, USB 1/2, and S/P DIF Input L/R** use the live audio from the selected input.

**L/R Output and Indiv. Output 1/2...3/4** use the audio as it is heard from the selected output (like connecting a cable from the output back to the input).

**REC 1/2...3/4 and FX Control 1, 2** use the audio from the selected bus.

**IFX 1...12, MFX 1, 2, and TFX 1, 2** use the output of the selected effect.

#### Channel Select [Stereo/L+R, Left, Right]

**Stereo/L+R:** This selection routes a stereo signal to EXi with stereo inputs, and an L+R summation to EXi with mono inputs.

**Left, Right:** This uses only a mono signal from the selected channel.

### 2-6b: EXi 2

EXi2 has the same controls as EXi1, above.

### ▼ 2-6: Page Menu Commands

The number before each command shows its ENTER + number-key shortcut. For more information on these shortcuts, see "ENTER + 0-9: shortcuts for menu commands" on page 147.

- 0: **Write Combination.** For more information, see "Write Combination" on page 501.
- 1: **Exclusive Solo.** For more information, see "Exclusive Solo" on page 147.
- 2: **Copy From Program.** For more information, see "Copy From Program" on page 501.

# Combination P3: MIDI Filter/Zones

## 3-1: MIDI Filter1

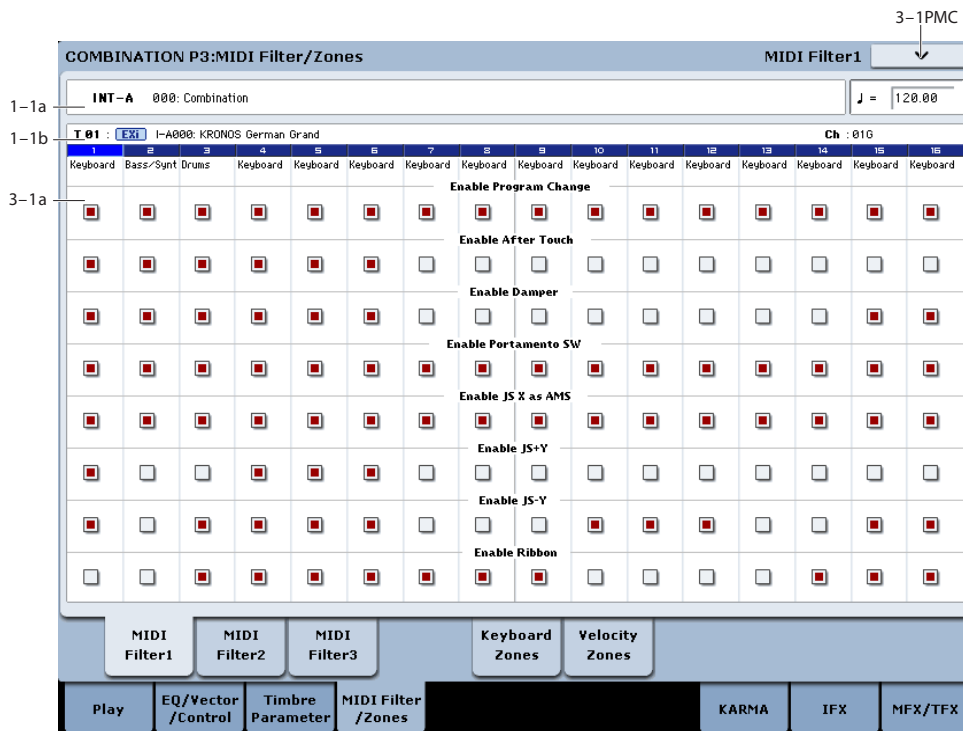

These settings allow you to apply filters to the MIDI data that will be transmitted and received by each timbre 1–16. For example even if two timbres are being played by the same MIDI channel, you can make settings so that the damper pedal will apply to one but not the other.

**On (checked):** Transmission and reception of MIDI data is enabled.

When **Status** (0–1b, 2–1a) is INT, operation of the built-in controllers or incoming MIDI data will apply the effect of the checked item to the program of the corresponding timbre. (The effect dynamic modulation function is not affected by this setting.)

In the case of EXT or EX2, operating a controller on the KRONOS will transmit MIDI data on the channel of that timbre. MIDI transmission/reception settings for the entire KRONOS can be made in “MIDI Filter” (Global 1–1b).

The MIDI Filter pages 2 and 3 contain MIDI filters for assignable controllers (whose function can be set by the user), and if these are assigned to MIDI control changes, the filter settings will affect those control changes. In this case, if the same control change as Knob 1, 2, 3, or 4 has been assigned in MIDI Filter pages 1 and 2, the settings in MIDI Filter pages 1 and 2 will take priority. Also, if the same control change is assigned to two or more controllers in the MIDI Filter pages 2 and 3, checking any one of them will enable that control change.

**Off (unchecked):** Transmission and reception of MIDI data is disabled.

*Note:* MIDI CC# = MIDI control change message numbers.

### 3-1a: MIDI Filter1

#### Timbre 01

**Enable Program Change** [Off, On]

Specifies whether or not MIDI program change messages will be transmitted and received.

**Enable After Touch** [Off, On]

Specifies whether or not MIDI after touch messages will be transmitted and received.

**Enable Damper** [Off, On]

Specifies whether or not MIDI CC#64 hold (damper pedal) messages will be transmitted and received.

**Enable Portamento SW** [Off, On]

Specifies whether or not MIDI CC#65 portamento on/off messages will be transmitted and received.

**Enable JS X as AMS** [Off, On]

Specifies whether or not MIDI pitch bend messages (the X axis of the KRONOS’s joystick) will be received to control the AMS effect assigned to JS X. (This is not a filter for MIDI pitch bend message reception.) For more information, please see “Alternate Modulation Sources (AMS)” on page 1089.

**Enable JS+Y** [Off, On]

Specifies whether MIDI CC#1 (the +Y axis of the KRONOS's joystick, or a realtime modulation knob assign setting) will be transmitted and received.

**Enable JS-Y** [Off, On]

Specifies whether MIDI CC#2 (the -Y axis of the KRONOS's joystick, or a realtime modulation knob assign setting) will be transmitted and received.

**Enable Ribbon** [Off, On]

Specifies whether or not MIDI CC#16 (the KRONOS's ribbon controller, or specified as the assignment of a realtime modulation knob) will be transmitted or received.

**Timbres 02...16**

These are the MIDI Filter1 settings for timbres 2 through 16. They are the same as for timbre 1. See "Timbre 01".

---

**▼ 3-1: Page Menu Commands**

The number before each command shows its ENTER + number-key shortcut. For more information on these shortcuts, see "ENTER + 0-9: shortcuts for menu commands" on page 147.

- **0: Write Combination.** For more information, see "Write Combination" on page 501.
- **1: Exclusive Solo.** For more information, see "Exclusive Solo" on page 147.
- **2: Copy From Program.** For more information, see "Copy From Program" on page 501.

## 3-2: MIDI Filter2

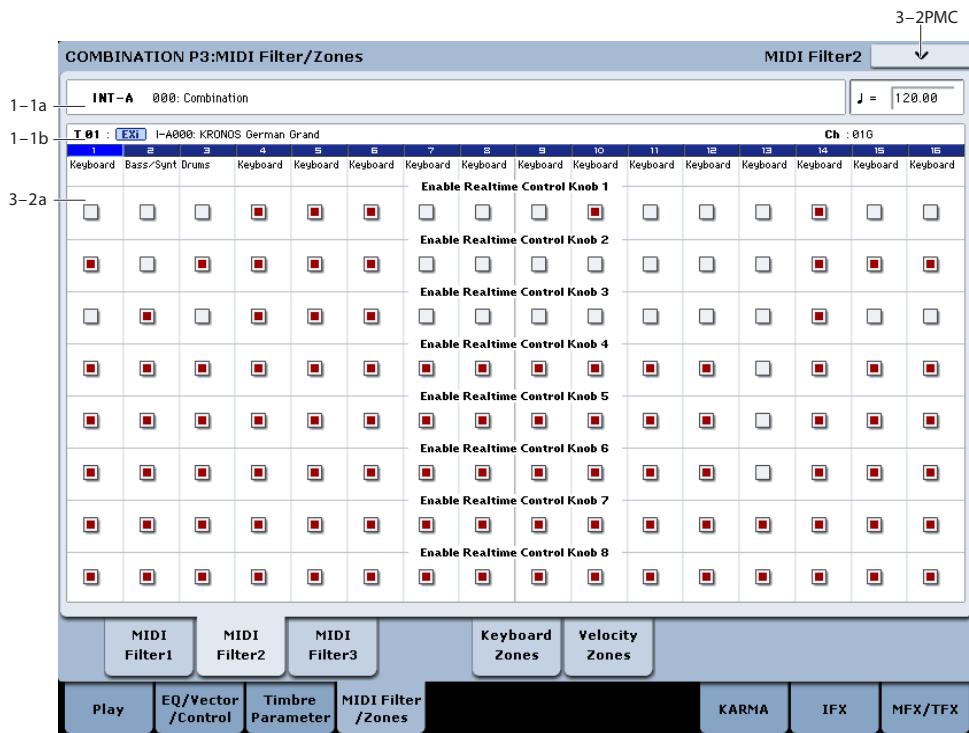

### 3-2a: MIDI Filter2

#### Timbre 01

##### Enable Realtime Control Knob 1 [Off, On]

Specifies whether Realtime Control knob 1 MIDI CC#74 (the KRONOS's filter cutoff frequency) will be received.

##### Enable Realtime Control Knob 2 [Off, On]

Specifies whether Realtime Control knob 2 MIDI CC#71 (the KRONOS's filter resonance) will be received.

##### Enable Realtime Control Knob 3 [Off, On]

Specifies whether Realtime Control knob 3 MIDI CC#79 (the KRONOS's filter EG intensity) will be received.

##### Enable Realtime Control Knob 4 [Off, On]

Specifies whether Realtime Control knob 4 MIDI CC#72 (the KRONOS's filter/amp EQ release time) will be received.

##### Enable Realtime Control Knob 5 [Off, On]

##### Enable Realtime Control Knob 6 [Off, On]

##### Enable Realtime Control Knob 7 [Off, On]

##### Enable Realtime Control Knob 8 [Off, On]

These specify whether MIDI message will be received for Realtime Control knobs 5 through 8.

#### Timbres 02...16

These are the MIDI Filter2 settings for timbres 2 through 16. They are the same as for timbre 1. See "Timbre 01".

### 3-2: Page Menu Commands

The number before each command shows its ENTER + number-key shortcut. For more information on these shortcuts, see "ENTER + 0-9: shortcuts for menu commands" on page 147.

- 0: **Write Combination.** For more information, see "Write Combination" on page 501.
- 1: **Exclusive Solo.** For more information, see "Exclusive Solo" on page 147.
- 2: **Copy From Program.** For more information, see "Copy From Program" on page 501.

### 3-3: MIDI Filter3

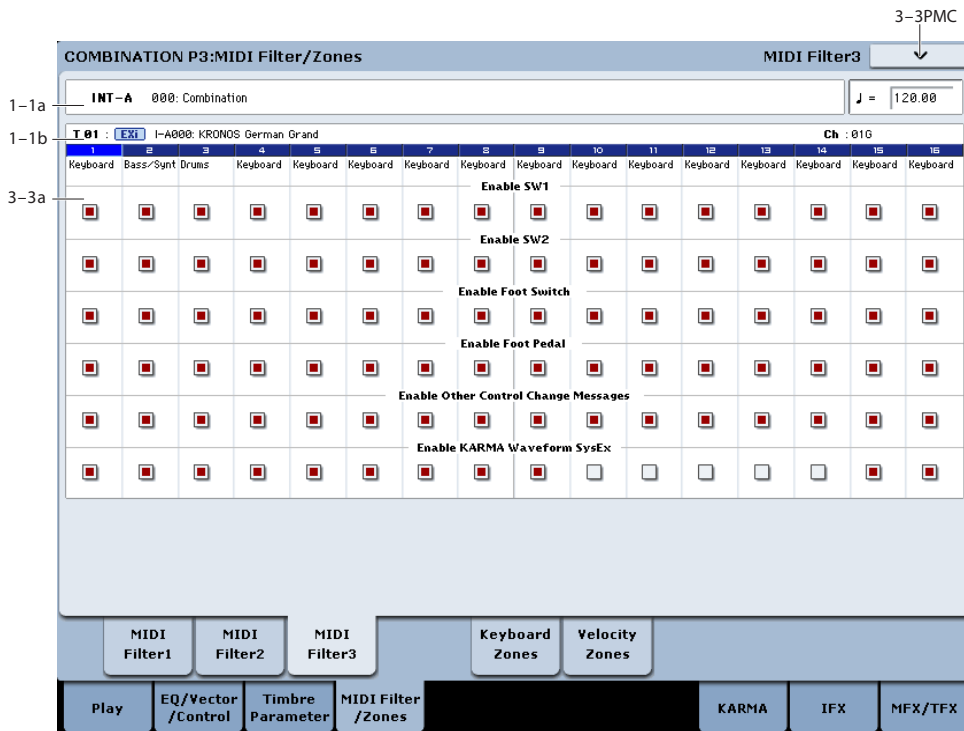

#### 3-3a: MIDI Filter3

##### Timbre 01

**Enable SW1** [Off, On]

**Enable SW2** [Off, On]

Specifies whether or not the effect of the SW1 and SW2 switches will be received.

The function of these switches is specified in the P1-Set Up Controllers page.

These settings are valid if these keys are assigned to SW1 Mod. (CC#80), SW2 Mod. (CC#81), or Portamento SW (CC#65).

**Enable Foot Switch** [Off, On]

Specifies whether or not the effect of the ASSIGNABLE SWITCH will be received. The function is assigned in Global P2- Controller page.

This filter setting is valid when a MIDI control change is assigned.

**Enable Foot Pedal** [Off, On]

Specifies whether or not the effect of the ASSIGNABLE PEDAL will be received. The function is assigned in Global P2- Controller page.

This filter setting is valid when a MIDI control change is assigned.

**Enable Other Control Change Messages** [Off, On]

Specifies whether or not MIDI control messages not covered in the preceding items MIDI Filter will be received.

**Enable KARMA Waveform SysEx** [Off, On]

This allows you to enable or disable the System Exclusive messages used by KARMA Wave Sequencing.

##### Timbres 02...16

These are the MIDI Filter3 settings for timbres 2 through 16. They are the same as for timbre 1. See "Timbre 01".

#### ▼ 3-3: Page Menu Commands

The number before each command shows its ENTER + number-key shortcut. For more information on these shortcuts, see "ENTER + 0-9: shortcuts for menu commands" on page 147.

- 0: **Write Combination.** For more information, see "Write Combination" on page 501.
- 1: **Exclusive Solo.** For more information, see "Exclusive Solo" on page 147.
- 2: **Copy From Program.** For more information, see "Copy From Program" on page 501.

### 3-5: Keyboard Zones

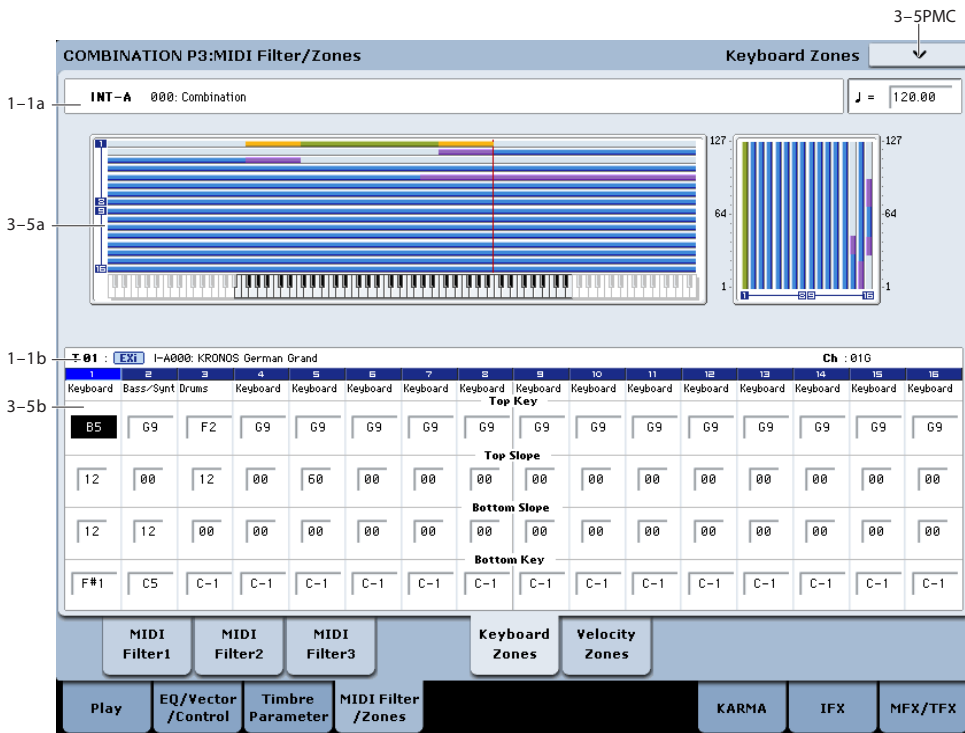

These settings specify the keyboard range in which each timbre will sound.

The top/bottom key parameters specify the range of notes in which timbres 1-16 will sound, and the top/bottom slope parameters specify the range over which the original volume will be reached.

**Key Split:** By setting timbres of different sounds to ranges that do not overlap, you can play different sounds in different ranges of the keyboard.

**Layer:** By setting the ranges to overlap, you can play two or more sounds with a single note.

**Positional Cross-fade:** If you set the slopes (the grayed portion) to overlap, the sounds will overlap, and the proportion of the overlap will change according to the keyboard location.

#### 3-5a: Zone Map

This area indicates the note and velocity ranges in which each timbre will sound.

The LCD screen will display a line to indicate the range of notes and velocities that will sound, and will show the slope portion.

#### Zone Map

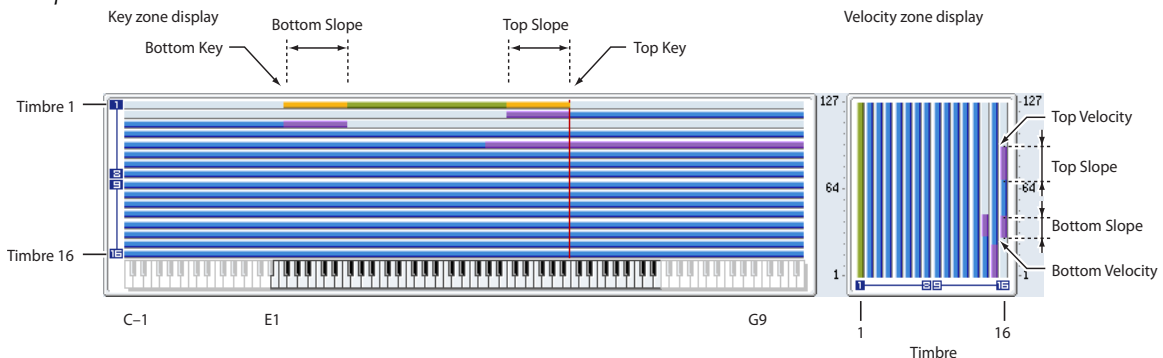

#### 3-5b: Keyboard Zones

##### Timbre 01

**Top Key** [C-1...G9]

Specifies the top key (upper limit) of the notes that will sound each timbre.

**Top Slope** [00, 01, 02, 03, 04, 06, 08, 10, 12, 18, 24, 30, 36, 48, 60, 72]

Specifies the range of keys (12 is one octave) over which the volume will be reached starting from the top key.

**0:** The volume will be at the original level from the top key.



**12:** The volume will increase gradually as you play downward, and will reach the original volume one octave below the top key.

**72:** The volume will increase gradually as you play downward, and will reach the original volume six octaves below the top key.

**Bottom Slope** [00, 01, 02, 03, 04, 06, 08, 10, 12, 18, 24, 30, 36, 48, 60, 72]

Specifies the range of keys (12 is one octave) over which the volume will be reached starting from the bottom key.

**0:** The volume will be at the original level from the bottom key.

**12:** The volume will increase gradually as you play upward, and will reach the original volume one octave above the bottom key.

**72:** The volume will increase gradually as you play upward, and will reach the original volume six octaves above the bottom key.

**Bottom Key** [C-1...G9]

Specifies the bottom key (lower limit) of the notes that will sound each timbre.

How volume will change according to keyboard location

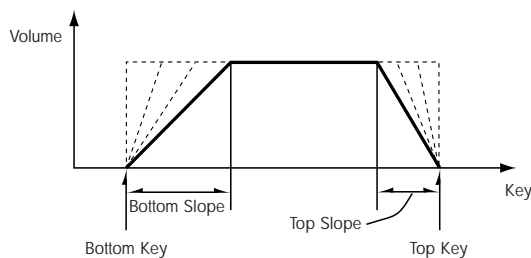

**Top Key** and **Bottom Key** settings can also be input by holding down the ENTER switch and playing a note on the keyboard.

⚠ It is not possible to set the bottom key above the top key of the same timbre. Nor is it possible for the top and bottom slopes to overlap.

### Timbres 02...16

These are the key zone settings for timbres 2 through 16. They are the same as for timbre 1. See "Timbre 01".

## ▼ 3-5: Page Menu Commands

The number before each command shows its ENTER + number-key shortcut. For more information on these shortcuts, see "ENTER + 0-9: shortcuts for menu commands" on page 147.

- **0: Write Combination.** For more information, see "Write Combination" on page 501.
- **1: Exclusive Solo.** For more information, see "Exclusive Solo" on page 147.
- **2: Copy From Program.** For more information, see "Copy From Program" on page 501.

### 3-6: Velocity Zones

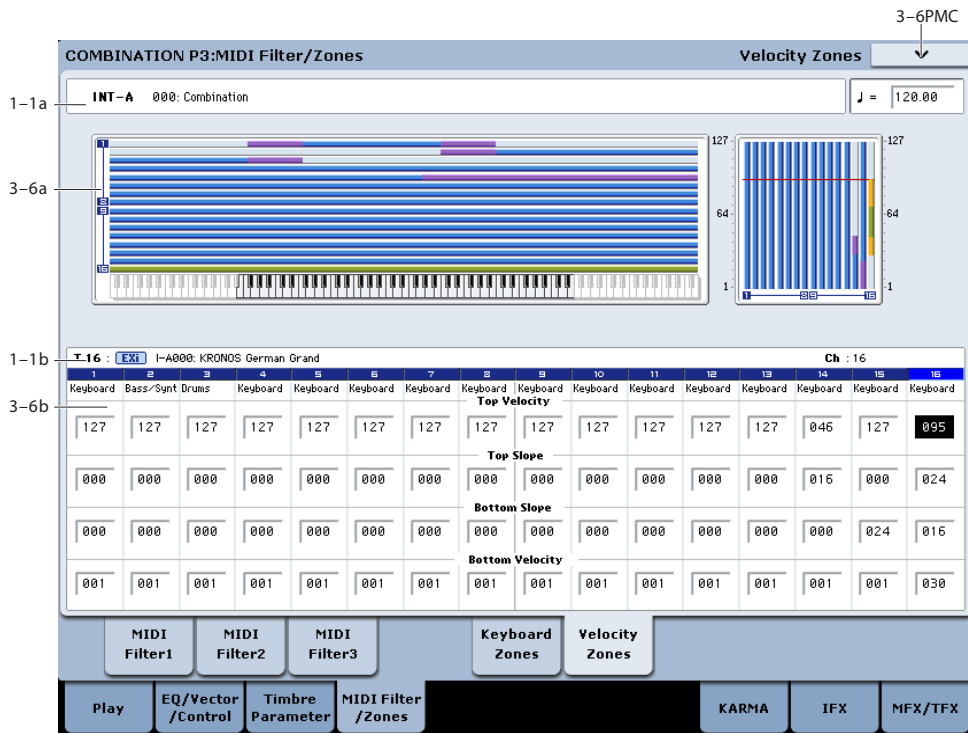

Sets the Top/Bottom Velocity parameters to specify the range of velocities that will sound for each timbre 1-16, and set the Top/Bottom Slope parameters to specify the range over which the volume will change.

**Velocity Switch:** By setting two or more timbres to velocity zones that do not overlap, you can use variations in playing dynamics to play different sounds.

**Layer:** If you set two or more timbres to velocity zones that overlap, the sounds will be heard together.

**Velocity Cross-fade:** If the slope ranges (gray line) overlap, different sounds will be sounded together, and your playing dynamics will determine the proportion of each sound.

⚠ It is not possible to set the bottom velocity greater than the top velocity for the same timbre. Nor can the top slope and the bottom slope overlap.

#### 3-6a: Zone Map

This area indicates the note and velocity ranges in which each timbre will sound.

For more information, please see "3-5a: Zone Map" on page 466.

#### 3-6b: Velocity Zones

##### Timbre 01

##### Top Velocity [1...127]

Specifies the maximum velocity value that will sound each timbre.

##### Top Slope [0...120]

Specifies the number of velocity steps over which the original volume will be reached, starting from the Top Velocity.

**0:** The volume will be at the original value from the top velocity.

**120:** The volume will decrease as the velocity approaches the top velocity.

##### Bottom Slope [0...120]

Specifies the number of velocity steps over which the original volume will be reached, starting from the Bottom Velocity.

**0:** The volume will be at the original value from the bottom velocity.

**120:** The volume will decrease as the velocity approaches the bottom velocity.

##### Bottom Velocity [1...127]

Specifies the minimum velocity value that will sound each timbre.

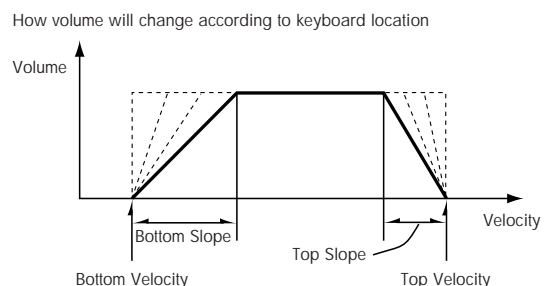

“Top Velocity” and “Bottom Velocity” settings can also be input by holding down the ENTER switch and playing a note on the keyboard.

### **Timbres 02...16**

These are the velocity zone settings for timbres 2 through 16. They are the same as for timbre 1. See “Timbre 01”.

---

### **▼ 3–6: Page Menu Commands**

The number before each command shows its ENTER + number-key shortcut. For more information on these shortcuts, see “ENTER + 0-9: shortcuts for menu commands” on page 147.

- **0: Write Combination.** For more information, see “Write Combination” on page 501.
- **1: Exclusive Solo.** For more information, see “Exclusive Solo” on page 147.
- **2: Copy From Program.** For more information, see “Copy From Program” on page 501.

## Combination P7: KARMA

Here you can make KARMA function settings for the combination. In Combination mode, you can use all four KARMA Modules (A, B, C, and D). This allows you to create a wide variety of setups, including assigning different phrases or patterns to different Programs.

### Turning KARMA on and off

KARMA can be enabled or disabled for the current Combination by using the front-panel KARMA ON/OFF switch. You can also temporarily disable KARMA for all Programs, Combinations, and Songs by using the Global All KARMA Off parameter. For more information, see “All KARMA/DT Off” on page 755.

### Linking KARMA settings to Program changes

KARMA settings can be saved individually for each Combination. This includes all of the KARMA-related front-panel buttons, sliders, and knobs, as well as the on-screen parameters.

Normally, when you select a new Combination, its KARMA settings will be loaded as well. In some cases, however, you may wish to try out different Combinations while keeping the KARMA settings the same.

The Global Basic page **Load KARMA Settings when changing** parameters let you select between these two behaviors. There are separate settings for Programs, Combis, and Songs. To set this up:

1. Go to the Global Basic page.
2. Under “Load KARMA setting when changing”, set the “Combinations” check-box as desired.

Check the box to load the individual Combinations’ KARMA settings.

Un-check the box to keep KARMA settings the same, even when changing Combinations.

For more information, see the Global parameter “Load KARMA settings when changing” on page 755.

## 7-1: GE Setup/Key Zones

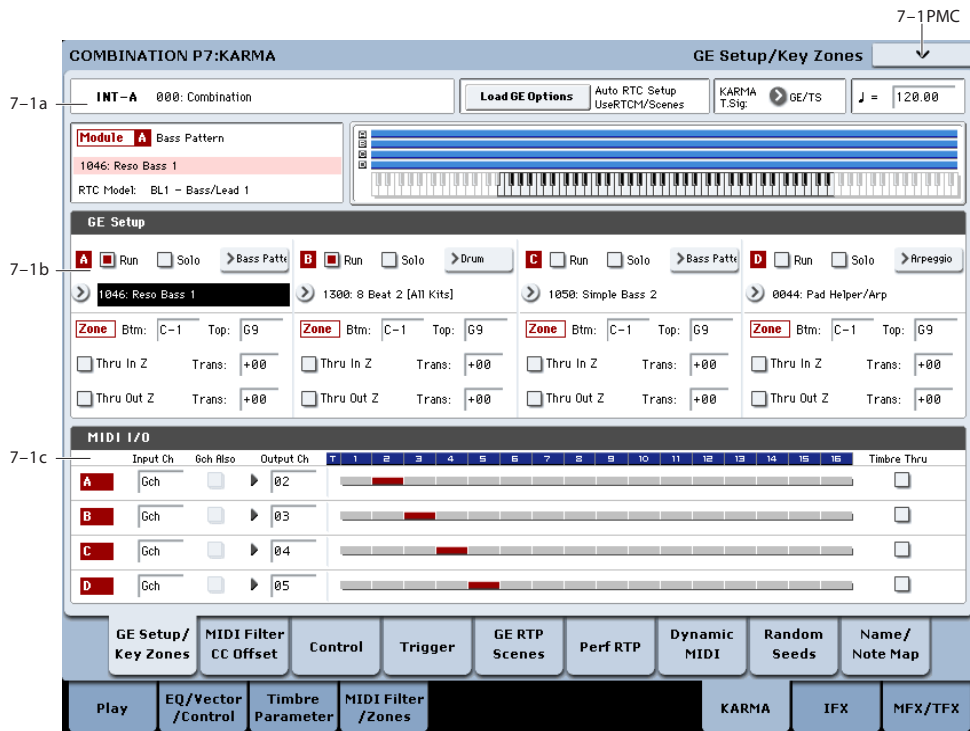

Here you can select the GE that will be used by each KARMA Module, and specify the Key Zone and MIDI Setup for the four KARMA Modules used by the combination.

### 7-1a: Combination Name, Load GE Options, KARMA T.Sig, Tempo

Bank [INT-A...G, USER-A...G]

Combination [0...127]

♪ (Tempo) [040.00...300.00, EXT]

These are the current bank, Combination, and Tempo. For more information, please see “1-1a: Combination Name” on page 440.

**Load GE Options** [Dialogue]

These options let you specify whether the values and assignments for controllers such as the KARMA SLIDERS 1-8 and KARMA SWITCHES 1-8 will be set automatically, be initialized, or be preserved when you select a GE.

For more information, see "Load GE Options" on page 9.

**KARMA T.Sig (Time Signature)**  
[GE/TS, 1/4...16/4, 1/8...16/8, 1/16...16/16]

This specifies the time signature of the phrases or patterns generated by the KARMA Modules. For more information, see "KARMA T.Sig (Time Signature)" on page 10.

**Selected KARMA Module Info**

**GE Category** [Arpeggio...Real-Time]

**GE No., GE Name** [Preset 0000...2047, USER-A...L 000...127]

**RTC Model** [List of RTC Models]

This shows the GE's RTC Model, as specified internally for each preset GE. For more information, see "Load GE Options" on page 9.

**Module Zone Display**

The key zone settings of each of the four KARMA Modules are displayed as a solid blue line.

For more information, please see "Module Zone Display" on page 109.

**7-1b: GE Setup/Key Zones**

**GE**

**Run** [Off, On]

Please see "Run" on page 422.

**Solo** [Off, On]

Please see "Solo" on page 422.

**GE Select** [Preset 0000...2047, USER-A...L 000...127]

This selects the GE for the KARMA module. There are a total of 3,584 to choose from: 2,048 preset GEs, and 1,536 rewritable User GEs (12 banks of 128 each).

For more information, see "GE Select" on page 423.

**GE Bank Select** [Preset...USER-L]

This selects the GE bank. The Preset bank is part of the system software; User banks can be loaded from disk. For more information, see "GE Select" on page 423.

**GE Category Select** [Arpeggio...Real-Time]

This lets you select a GE by category, from Arpeggio through Real-Time.

**Key Zones**

**Bottom (Key Zone Bottom)** [C-1...G9]

**Top (Key Zone Top)** [C-1...G9]

For more information, see "Key Zone" on page 108.

Note: In Combination mode, each KARMA Module also has its own MIDI Input Channel and Output Channel, as described under "7-1c: MIDI I/O," below.

**Transpose**

**Thru In Zone** [Off, On]

**Transpose In Zone** [-36...+36]

**Thru Out Zone** [Off, On]

**Transpose Out Zone** [-36...+36]

Please see "Key Zone" on page 108.

**7-1c: MIDI I/O**

Specifies the MIDI input/output channels for the four KARMA Modules used by the combination.

**Input Channel** [01...16, Gch]

Specifies the MIDI input channel for each KARMA Module.

MIDI data from the keyboard or from MIDI IN that matches the specified MIDI channel will be input to the KARMA Module. (See "KARMA - MIDI Input/Output Channel" in the diagram below.)

Gch: The MIDI channel will always match the global MIDI channel (Global P1-1a).

When using KARMA with keyboard playing in Combination mode, you will normally select Gch.

KARMA - MIDI Input / Output Channel

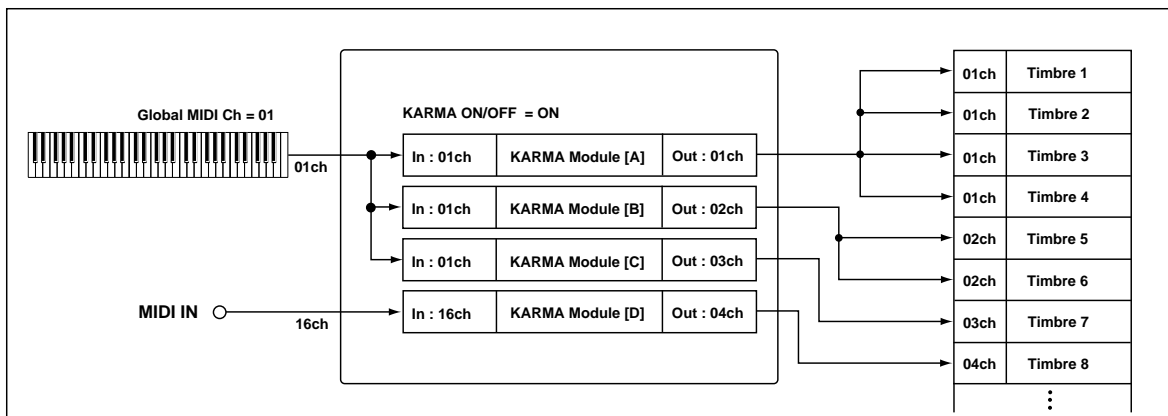

**Gch Also** [Off, On]

Determines whether input on the Global Channel will also be used for the selected Module, in addition to the channel that is selected in the "Input Channel."

**Off (unchecked):** The selected Module will receive data from the specified "Input Channel," and will not receive data from the Global Input Channel.

**On (checked):** The selected Module will receive data from the specified **Input Channel** and the Global Input Channel.

This is useful when using a pad on a specific MIDI Channel to send data into a Module. Turning "Gch Also" On (checked) allows a keyboard (sending on the Global Channel) to also control the same Module.

⚠ Not available unless the Module's **Input Channel** is set to something other than Gch or global MIDI channel.

**Output Channel** [01...16, Gch]

Specifies the MIDI output channel for each KARMA Module.

The MIDI data from the KARMA Module will be transmitted on the specified MIDI channel, and will sound timbres whose channel matches. (See the diagram below, "KARMA-MIDI Input/Output Channel.")

**Gch:** The MIDI channel will always match the global **MIDI channel** (Global P1-1a).

**Timbre Thru (when KARMA Off)** [Off, On]

**Input Channel** and **Output Channel** settings are normally valid only when the KARMA ON/OFF switch is on.

As an exception, **Timbre Thru** specifies whether MIDI data that has passed through the KARMA Module will be sent (Thru) to timbres when KARMA is off.

**On (checked):** When KARMA is off, MIDI data that has passed through the KARMA Module will be sent via the **Output Channel** to timbres.

**Off (unchecked):** When KARMA is off, MIDI data that has passed through the KARMA Module will not be sent to timbres.

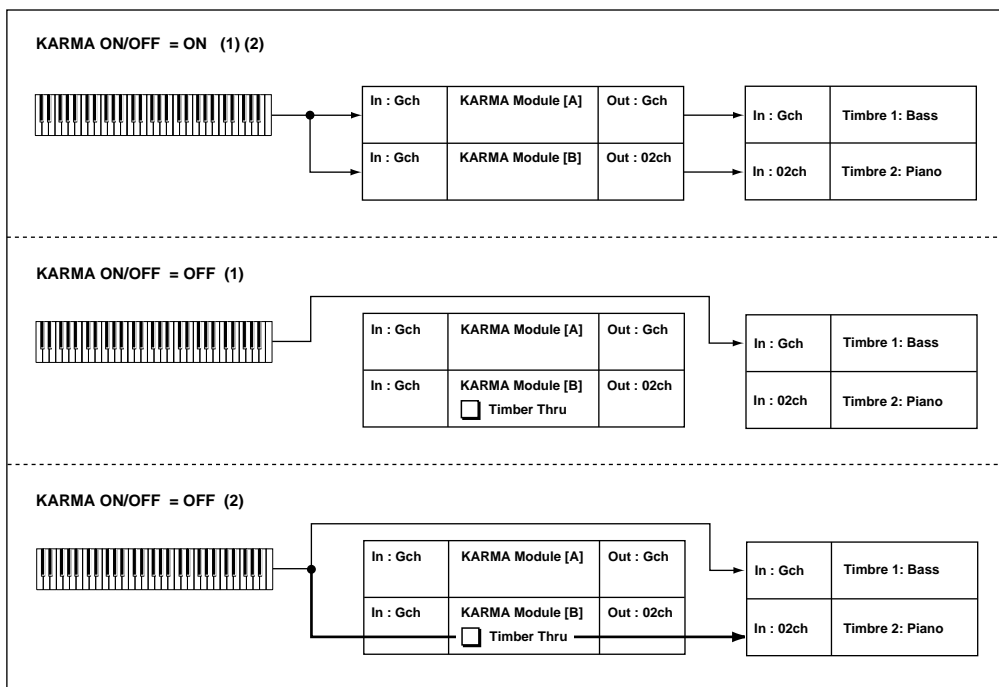

If you wish to apply separate phrases or patterns by using KARMA Module A for timbre 1 and KARMA Module B for timbre 2, set the MIDI channels as follows:

**Example setting 1**

1. Set the global MIDI channel (Global 1-1a: MIDI Channel) to 01.
2. Set timbre 1 as follows.  
Program Select: Bass program  
MIDI Channel (2-1): Gch
3. Set timbre 2 as follows.  
Program Select: Piano program  
MIDI Channel (2-1): 02
4. Set KARMA Module A as follows.  
GE Select: Any riff from the Bass GE category

**Input Channel:** Gch  
**Output Channel:** Gch  
**Timbre Thru:** Off

5. Set KARMA Module B as follows.

GE Select: Any riff from the Keyboard GE category  
**Input Channel:** Gch  
**Output Channel:** 02  
**Timbre Thru:** Off

6. Turn the KARMA ON/OFF switch on.

When you play the keyboard, KARMA Module A will play the bass of timbre 1, and KARMA Module B will play the piano of timbre 2. (See "KARMA ON/OFF=ON (1)(2)" in the diagram above.)

7. Turn the KARMA ON/OFF switch off.

When you play the keyboard, you will hear the bass of timbre 1, whose MIDI channel is set to Gch. Since timbre 2 is set to MIDI channel 2, it will not sound in response to the keyboard. (See “KARMA ON/OFF=OFF (1)” in the diagram above.)

**Example setting 2**

1. Follow steps 1-3 from Example setting 1, above.
2. Set KARMA Module A as follows.

**GE Select:** Any riff from the Bass GE category  
**Input Channel:** Gch  
**Output Channel:** Gch  
**Timbre Thru:** Off

3. Set KARMA Module B as follows.

**GE Select:** Any riff from the Keyboard GE category  
**Input Channel:** Gch  
**Output Channel:** 02  
**Timbre Thru:** On

4. Turn the KARMA ON/OFF switch on.

When you play the keyboard, the result will be the same as for step 6 in Example setting 1. (See “KARMA ON/OFF=ON (1)(2)” in the diagram above.)

5. Turn the KARMA ON/OFF switch off.

When you play the keyboard, you will hear the bass timbre, whose MIDI channel is Gch. The piano of timbre 2 will also be played by the keyboard because of the **Timbre Thru On** setting of KARMA Module B. (See “KARMA ON/OFF=OFF (2)” in the diagram above.)

**Module – Timbre MIDI Display**

This shows the timbres that will be sounded by each KARMA Module, according to the MIDI output channel settings of each KARMA Module and the MIDI channel of each timbre (2-1a).

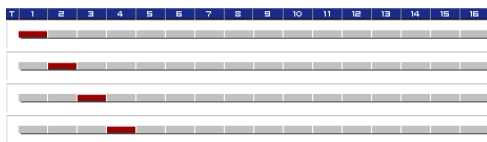

- 5: **Swap Scene.** For more information, see “Swap Scene” on page 157.
- 6: **Capture Random Seed.** For more information, see “Capture Random Seed” on page 157.
- 7: **Copy From Program.** For more information, see “Copy From Program” on page 501.

**▼ 7-1: Page Menu Commands**

The number before each command shows its ENTER + number-key shortcut. For more information on these shortcuts, see “ENTER + 0-9: shortcuts for menu commands” on page 147.

- 0: **Write Combination.** For more information, see “Write Combination” on page 501.
- 1: **Exclusive Solo.** For more information, see “Exclusive Solo” on page 147.
- 2: **Copy KARMA Module.** For more information, see “Copy KARMA Module” on page 504.
- 3: **Initialize KARMA Module.** For more information, see “Initialize KARMA Module” on page 505.
- 4: **Copy Scene.** For more information, see “Copy Scene” on page 157.



## 7-2: MIDI Filter/CC Offset

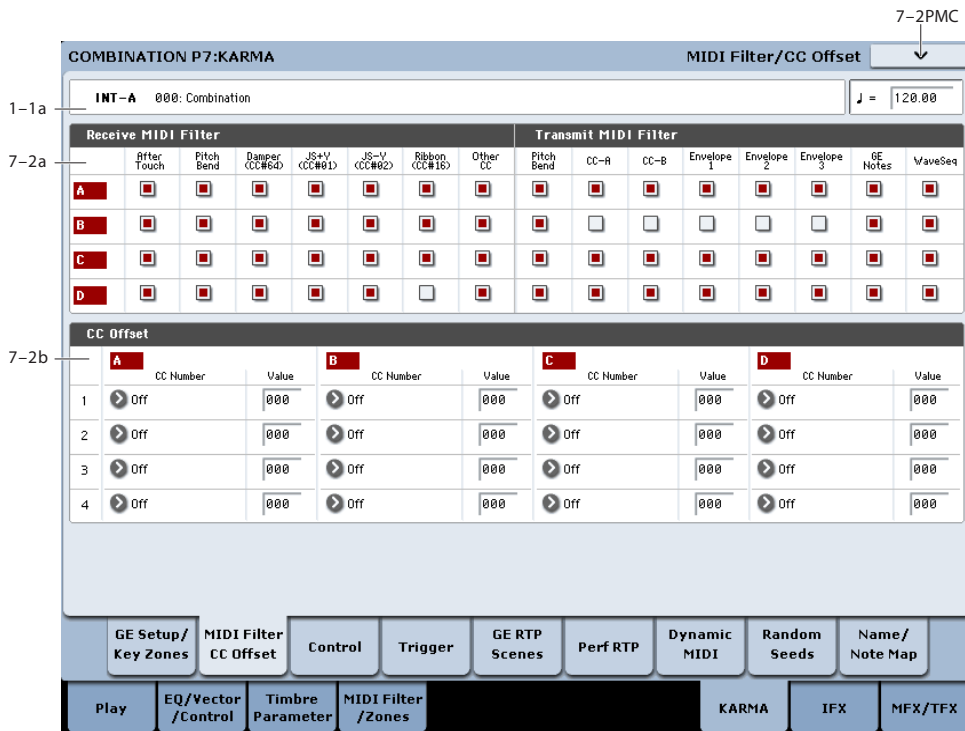

### 7-2a: MIDI Filter

#### Receive MIDI Filter

For each KARMA Module, specify whether to filter the MIDI control data received by the Module.

<b>After Touch</b>	<b>[Off, On]</b>
<b>Pitch Bend</b>	<b>[Off, On]</b>
<b>Damper (CC#64)</b>	<b>[Off, On]</b>
<b>JS+Y (CC#01)</b>	<b>[Off, On]</b>
<b>JS-Y (CC#02)</b>	<b>[Off, On]</b>
<b>Ribbon (CC#16)</b>	<b>[Off, On]</b>
<b>Other CC</b>	<b>[Off, On]</b>

Please see “Receive MIDI Filter” on page 110.

#### Transmit MIDI Filter

For each KARMA Module, specify whether to filter the MIDI control data generated by the GE selected for the Module.

<b>Pitch Bend</b>	<b>[Off, On]</b>
-------------------	------------------

Please see “Transmit MIDI Filter” on page 111.

If KARMA is on and a KARMA Module is generating pitch bend data, the Bend Range (“2-3a: Pitch” on page 457) of the timbre will be controlled as follows.

The pitch bend range specified within the KARMA GE will be transmitted from the KARMA Module so that the corresponding timbre will be forcibly set to this bend range. This ensures that the pitch bend

data generated by the KARMA Module’s GE will function as intended. At this time, pitch bender data produced by operating the joystick will automatically be adjusted to produce the same bend effect as when KARMA is off (in most cases). If multiple timbres are being controlled by one KARMA Module, the settings of the lowest-numbered timbre will be used.

<b>CC-A, CC-B</b>	<b>[Off, On]</b>
<b>Envelope1, Envelope2, Envelope3</b>	<b>[Off, On]</b>
<b>GE Notes</b>	<b>[Off, On]</b>
<b>WaveSeq</b>	<b>[Off, On]</b>

For more information, see “Transmit MIDI Filter” on page 111.

### 7-2b: CC Offset

When KARMA is turned on, MIDI control change messages are transmitted to the tone generator. This lets you use MIDI control change messages to control program sounds or effects when KARMA is on.

These messages will be transmitted on the “Output Channel” (7-1c) of the KARMA Module.

For more information, see, “7-2c: CC Offset” on page 111.

**CC Number** [Off, MIDI CC#00...CC#95]  
**Value** [000...127]

▼ 7-2: Page Menu Commands

The number before each command shows its ENTER + number-key shortcut. For more information on these shortcuts, see “ENTER + 0-9: shortcuts for menu commands” on page 147.

- 0: **Write Combination.** For more information, see “Write Combination” on page 501.
- 1: **Exclusive Solo.** For more information, see “Exclusive Solo” on page 147.

- 2: **Copy KARMA Module.** For more information, see “Copy KARMA Module” on page 504.
- 3: **Initialize KARMA Module.** For more information, see “Initialize KARMA Module” on page 505.
- 4: **Copy Scene.** For more information, see “Copy Scene” on page 157.
- 5: **Swap Scene.** For more information, see “Swap Scene” on page 157.
- 6: **Capture Random Seed.** For more information, see “Capture Random Seed” on page 157.
- 7: **Copy From Program.** For more information, see “Copy From Program” on page 501.

7-3: Module Parameters-Control

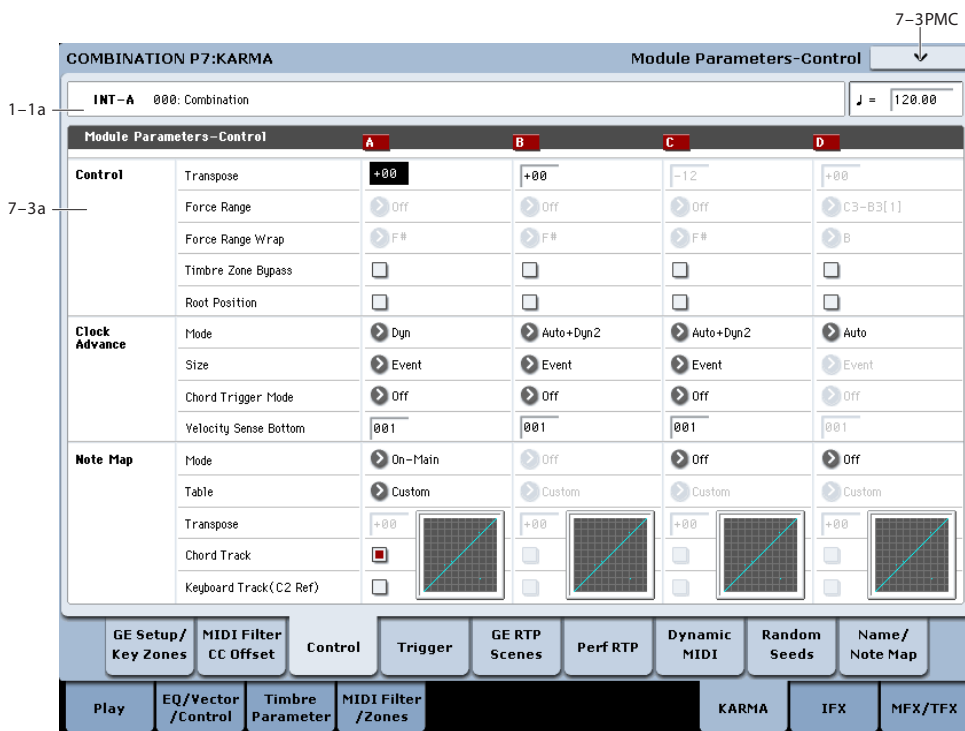

Here you can set KARMA Module Control parameters. In Combination mode, four KARMA Modules (A, B, C, and D) can be used.

7-3a: Module Parameter-Control

**Control**

**Transpose** [-36...+36]  
**Force Range** [Off, Lowest, Highest, C3-B3[1], C3-B3[2]]  
**Force Range Wrap** [C#...C]  
**Root Position** [Off, On]

Please see “Control” on page 113.

**Timbre Zone Bypass**

[Off, On]

Specifies whether the key zone settings (3-5) and velocity zone settings (3-6) of the timbre will be applied to the phrase or pattern generated by the KARMA Module.

**On (checked):** The key zone settings and velocity zone settings of the timbre will be bypassed for the phrase or pattern generated by the KARMA Module. The settings of the timbre will be ignored, and the notes generated by the KARMA Module will be sounded.

**Off (unchecked):** The key zone settings and velocity zone settings of the timbre will be applied to the phrase or pattern generated by the KARMA Module. Notes generated by the KARMA Module will not be sounded if they are outside the key zone or velocity zone of the timbre.

**Clock Advance**

**Mode** [Auto, Dyn, Auto+Dyn, Auto+Dyn2]

**Size** [Musical notation icon] **Event**

**Chord Trigger Mode**  
[Off, 1st, Chord1, Chord2, Chord3]

**Velocity Sense Bottom** [001...127]

Please see "Clock Advance" on page 114.

**Note Map**

**Mode (Note Map Mode)**  
[Off, On-Main, On-Rpt, On-All]

**Table (Note Map Table)**  
[Custom, Gtable 1...Maj 7 -> oct]

**Transpose (Note Map Transpose)** [-12...+12]

**Chord Track (Note Map Chord Track)** [Off, On]

**Keyboard Track (C2 Ref)**  
**(Note Map Keyboard Track)** [Off, On]

**Note Map Table Display**  
Please see "Note Map" on page 115.

**▼ 7-3: Page Menu Commands**

The number before each command shows its ENTER + number-key shortcut. For more information on these shortcuts, see "ENTER + 0-9: shortcuts for menu commands" on page 147.

- 0: **Write Combination**. For more information, see "Write Combination" on page 501.
- 1: **Exclusive Solo**. For more information, see "Exclusive Solo" on page 147.
- 2: **Copy KARMA Module**. For more information, see "Copy KARMA Module" on page 504.
- 3: **Initialize KARMA Module**. For more information, see "Initialize KARMA Module" on page 505.
- 4: **Copy Scene**. For more information, see "Copy Scene" on page 157.
- 5: **Swap Scene**. For more information, see "Swap Scene" on page 157.
- 6: **Capture Random Seed**. For more information, see "Capture Random Seed" on page 157.
- 7: **Copy From Program**. For more information, see "Copy From Program" on page 501.

**7-4: Module Parameters-Trigger**

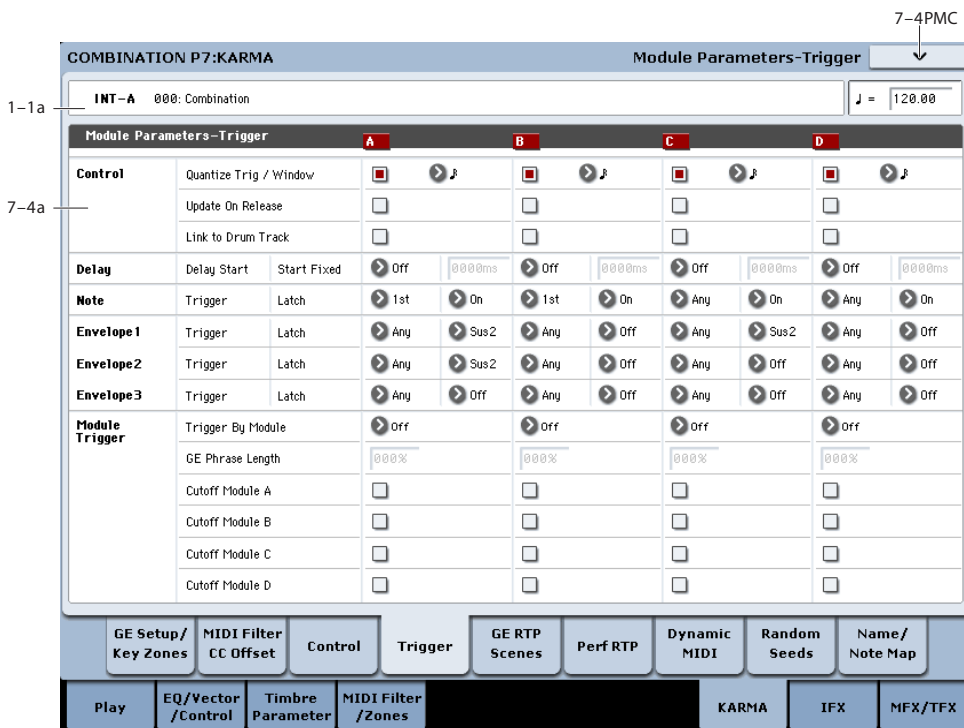

Specifies the trigger conditions and latch on/off for the GE that is selected for each KARMA Module, A-D.

## 7-4a: Module Parameter-Trigger

### Control

<b>Quantize Trigger</b>	[Off, On]
<b>Quantize Window</b>	
<b>Update On Release</b>	[Off, On]
<b>Link to Drum Track</b>	[Off, On]

Please see "Control" on page 117.

### Delay

<b>Delay Start</b>	[Off, Fixed, 64T ...4x1]
<b>Delay Start Fixed</b>	[0000ms...5000ms]

Please see "Delay" on page 118.

### Note

<b>Note Trigger</b>	[Any, AKR, 1st, Dyn]
---------------------	----------------------

Please see "Note Trigger" on page 118.

<b>Note Latch</b>	[Off, On]
-------------------	-----------

Please see "Note Latch" on page 118.

*Note:* In Combination mode, this can be turned on/off for each KARMA Module. A KARMA Module for which this is On (checked) will be in a Latch On condition when the LATCH switch is on (LED lit).

### Envelope1, Envelope2, Envelope3

<b>Trigger</b>	[Any, AKR, 1st, Dyn]
<b>Latch</b>	[Off, Sus1, Rel1, Sus2, Rel2]

Please see "Envelope1, Envelope2, Envelope3" on page 118.

### Module Trigger

Note and envelope triggering of a KARMA Module can be controlled by the operation of another KARMA Module.

<b>Trigger By Module</b>	[Off, A, B, C, D]
--------------------------	-------------------

When the KARMA Module you specify here advances by the length specified in "GE Phrase Length," the KARMA Module itself will be triggered automatically, starting the phrase or pattern.

For example you could make settings so that harp glissando phrases specified for each KARMA Module are triggered consecutively. Alternatively, you could make settings so that the four KARMA Modules are connected in series, and play repeatedly.

<b>GE Phrase Length</b>	[000...100%]
-------------------------	--------------

Specifies a percentage of a Module's overall GE Phrase Length after which triggering of this Module will occur. When the KARMA Module chosen above advances by the percentage of length specified here, this Module will be automatically triggered.

- This is valid except when **Trigger By Module** is Off.
- Setting a Module to be triggered by a percentage of its own phrase will have no additional effect.

**Note:** The actual overall GE Phrase Length is determined by the number of Phase Pattern Steps, the Phase Length Mode, and various other internal GE settings.

<b>Cutoff Module A, B, C, D</b>	[Off, On]
---------------------------------	-----------

When this Module's effect is triggered, it can cutoff any effects that are playing on the specified Modules.

This is mainly for use when you do not want effects from the Modules overlapping each other, but want them to appear continuous (i.e. 4 sax riffs, 4 different strumming effects, etc.). For example, you could trigger different Modules in separate areas of the keyboard, and only have one playing at any particular time.

This can also be used to cycle back and forth between Modules, with each Module shutting off the previous Module when it is triggered in.

## ▼ 7-4: Page Menu Commands

The number before each command shows its ENTER + number-key shortcut. For more information on these shortcuts, see "ENTER + 0-9: shortcuts for menu commands" on page 147.

- 0: **Write Combination.** For more information, see "Write Combination" on page 501.
- 1: **Exclusive Solo.** For more information, see "Exclusive Solo" on page 147.
- 2: **Copy KARMA Module.** For more information, see "Copy KARMA Module" on page 504.
- 3: **Initialize KARMA Module.** For more information, see "Initialize KARMA Module" on page 505.
- 4: **Copy Scene.** For more information, see "Copy Scene" on page 157.
- 5: **Swap Scene.** For more information, see "Swap Scene" on page 157.
- 6: **Capture Random Seed.** For more information, see "Capture Random Seed" on page 157.
- 7: **Copy From Program.** For more information, see "Copy From Program" on page 501.

## 7-5: GE Real-Time Parameters/Scenes

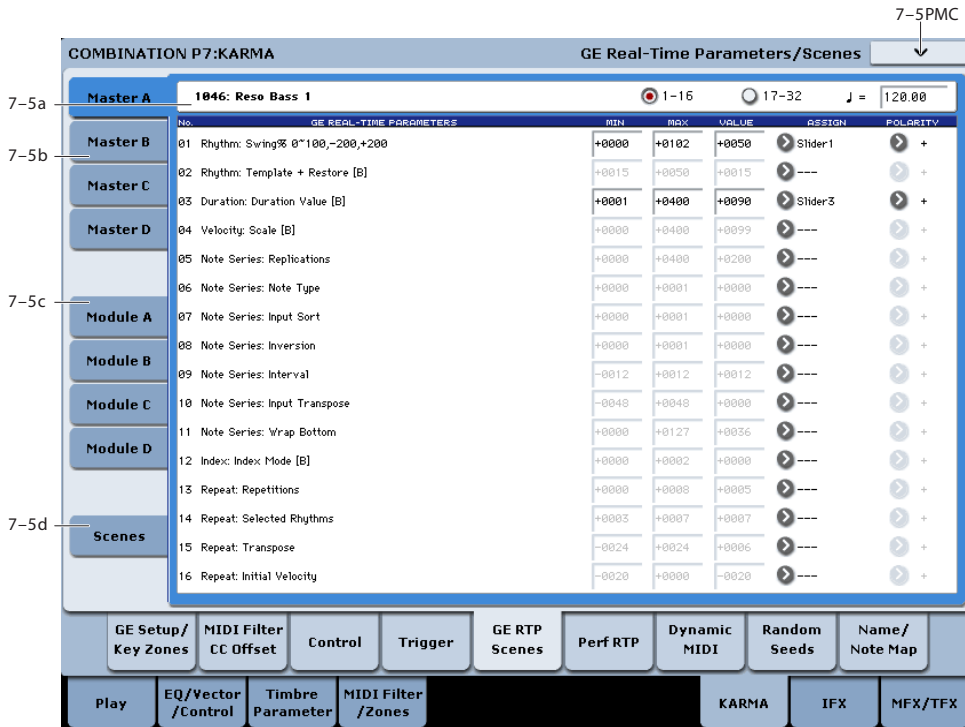

Here you can edit the Real-Time Parameters of the GE for each KARMA Module, A–D. In addition, you can assign GE Real-Time Parameters to the KARMA Real-Time Controls so that you can control the phrase or pattern in real-time while you play.

### 7-5a: GE Number & Name, RTC Select, and Tempo

#### GE Number & Name

[0000: Arp Model 01 Up/Dn...  
2047: Tempo Env Repeats]

This shows the GE selected for the Module. For more information, please see “0-6b: GE Select” on page 10.

#### GE RTC Select [1-16, 17-32]

This switches the GE realtime parameter display.

1-16: GE parameters 1-16 will be displayed.

17-32: GE parameters 17-32 will be displayed.

#### ♩ (Tempo) [040.00...300.00, EXT]

For more information, please see “Tempo” on page 5.

### 7-5b: GE Real-Time Parameters for Module Control = Master

Module Control = Master lets you use a single controller (e.g., Slider 1) to control multiple KARMA Modules simultaneously, or control individual parameters from different Modules conveniently at the same time.

### GE Real-Time Parameters 01...32

Here you can edit GE parameters and assign GE parameters to KARMA Real-Time Controls etc. for use with Module Control = Master.

#### GE PARAMETER (GE Real-Time Parameter)

**MIN (Minimum Value)** [-5000...+5000]

**MAX (Maximum Value)** [-5000...+5000]

**VALUE** [-5000...+5000]

**ASSIGN** [---, Slider1...8, Slider (SW)1...8, SW1...8, DynaMIDI1...8]

**POLARITY** [+,-]

Please see “7-5b: GE Real-Time Parameters” on page 120.

*Note:* Normally, the **MIN**, **MAX**, **VALUE**, and **POLARITY** parameters of each module are specified in module A, B, C, and D. These parameter settings are possible if you specify **ASSIGN** in Master A, B, C, and D.

For example if you want to use Slider1 to control the GE REALTIME PARAMETER No.1 of modules A, B, C, and D when Module Control is set to Master, you would set the Master, A, B, C, and D’s GE REALTIME PARAMETER No.01 **ASSIGN** to Slider1. If these are set to **ASSIGN**, you are able to edit the **MIN**, **MAX**, **VALUE**, and **POLARITY** parameters for Master, A, B, C, and D.

In this way, you can make GE realtime parameter settings independently of modules A, B, C, and D.

### 7-5c: GE Real-Time Parameters for Module Control = A, B, C, D

Module Control = A, B, C and D let you control GE Real-Time Parameters independently for the corresponding KARMA Module.

#### GE Real-Time Parameters 01...32

Here you can edit the GE Real-Time Parameters of each KARMA Module and assign them to KARMA Real-Time Controls for use with Module Control = Master, A, B, C and D.

Please see "GE Parameter 01...32" on page 120.

### 7-5d: Module Control Scene Matrix

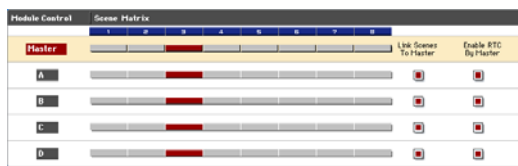

Here you can conveniently view and edit the selected Scenes for each of the five Module Control layers at the same time. You can also set a Scene Change Quantize Window that controls a time interval for when the scene changes will occur, and view information about upcoming scene changes.

#### Scene Change Quantize Window

##### Scene Change Quantize Window

 1 Bar...4 Bars]

This specifies the metric division by which scene changes will be quantized, in any of the Module Layers. Depending on the setting, this may delay the scene change from occurring until the next beat, next bar, or several bars later.

: These smaller values set the window as a note value relative to the tempo. For triplet-based patterns, you may need to select one of the triplet-based settings if you intend to perform scene changes "off the beat."

1 Bar...4 Bars: These larger values set the window in terms of measures, relative to both the tempo and the time signature of the Performance or the individual Module's GE.

Note: if the KARMA T.Sig (Time Signature) is set to something other than "0 GE/TS", then the specified Time Signature is what will be used to calculate the bar lengths. If the KARMA T.Sig is set to "0 GE/TS" (meaning that each Module's GE uses its own stored internal time signature), then the bar length is calculated using an internal averaging formula based on the Time Signatures of all GEs that are in use. For more information, see "KARMA T.Sig (Time Signature)" on page 10

**Note:** Scene changes selected at a timing that is within a 32nd note of the Scene Change Quantize Window setting will be considered "late" (shown by the pink color in the diagram above), and will cause the scene change to occur immediately. If the scene change is later than this, it will be considered "early" (shown by

the yellow color in the diagram above), and will occur at the next metric division corresponding to the Scene Change Quantize Window. (Due to space, not all settings are shown in the diagram.)

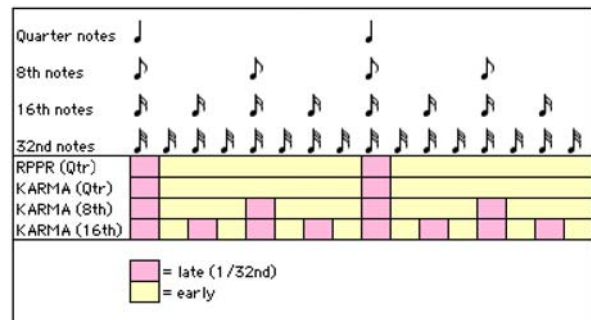

#### Scene Selection

This area includes a row of buttons for each Module, with the top row corresponding to the Master setting. Each row has eight buttons corresponding to the eight front panel Scene Switches. This lets you select any scene in any layer directly, without changing the Module Control setting. The grid shows an overview of which Scene is selected in any of the layers at any given time.

- Master** [1...8]
- A** [1...8]
- B** [1...8]
- C** [1...8]
- D** [1...8]

You can touch any row and change scenes in any Module, or change Scenes in the Master Layer and consequently change the other layers if they are linked to it (if "Link Scenes To Master" is on (checked)).

If you touch the label on the left side, you will change the "Module Control" setting to the selected layer, and the light orange row will indicate the current Module Control setting.

#### Link Scenes To Master

- A** [Off, On]
- B** [Off, On]
- C** [Off, On]
- D** [Off, On]

**On (checked):** Changing a Scene in the Master Layer selects a new Scene for the linked Module Layer. All four Modules independently store their current Scene in the top level Master Scene. It can be the same Scene for each linked Module, or completely different Scenes. This allows complete flexibility as to which Modules have which Scenes in which combinations.

This is the mode you would use mainly in Combination mode, for real-time play, and for setting up "Song Templates" (Combinations made to be song inspiration templates, i.e. Scenes similar to verses, choruses, fills, etc.) For example if master buffer 1 is



selected, Module A (e.g., drum pattern) could be switched to scene 5, and Module B (e.g., bass riff) could be switched to scene 8.

**Off (unchecked):** Changing a Scene in the Master Layer only changes Module parameters assigned to KARMA SLIDERS and SWITCHES in the Master Layer. The Module Layers do not change Scenes, but stay where they are.

Each layer is independent - this is the mode you would use mainly in the sequencer when you want to copy in four unrelated KARMA GEs one a time and use them in a song. In this case, you do not usually want them to be connected to each other.

### Enable RTC By Master

**A** [Off, On]

**B** [Off, On]

**C** [Off, On]

**D** [Off, On]

**Off (unchecked):** If there are controls in the Master Layer that are assigned to the specified Module, moving them or changing scenes in the Master Layer will have no effect on the Module's parameters.

This allows you to "disconnect" a Module Layer from the Master and "freeze" its current sound (in conjunction with turning **Link Scenes To Master** off).

**On (checked):** If there are controls in the Master Layer that are assigned to the specified Module, moving them or changing scenes in the Master Layer will affect the parameters and sound of the Module.

**Note:** In order to completely disconnect a Module from alteration by the Master Layer ("freeze" its settings), you need to uncheck both **Link Scenes To Master** and **Enable RTC By Master**. If you only disable **Link Scenes To Master**, the settings of the Master Scenes may still influence any parameters that are hooked up to controls in both the Master and Module Layers, depending on whether they were last moved in the Master.

Of course, any Module's Real-Time Parameters that are only assigned to controls in the Master Layer for that Module will also be affected by the Master Scenes, unless **Enable RTC By Master** is Off (unchecked).

 When **Enable RTC By Master** is turned Off (unchecked), any parameters that are assigned to controls in both the Master and Module Layers may change, because the values for the Module Layer will be sent out for whatever scene is selected in the Module Layer.

In other words, if Duration % (Gate) is assigned in both layers to a Slider, and it was last moved in the Master Layer, the GE will be playing with the Master Layer duration setting. If you disconnect the Master Layer, the duration value indicated by the Module Layer will be sent out. You can adjust the Module Layer's Duration % (Gate) control to sound the same at that point, if desired.

Turning "Enable RTC By Master" back on will resend the Master Layer's duration setting, if it was the last moved control connected to the duration in that Master Scene.

### Drum Track Run

#### Drum Track Run 1...8

[Off, On]

These 8 check-boxes determine whether or not the Drum Track will run for each of the KARMA scenes. For more information, see "Using KARMA and the Drum Track together" on page 243 of the Operation Guide.

### Scene Status

This area displays information related to upcoming scene changes. When using the Scene Change Quantize Window with longer settings such as 1, 2 or 4 bars, you can select a scene change in any of the layers several beats or more in advance of when you want it to occur. The Control Surface and Scene Matrix will change to the new scene immediately, but internally the scene change will not occur until the specified time interval has elapsed. The Scene Status area displays a message indicating a pending scene change for a particular layer, from the current scene to the new scene. You can use this to "cancel" a pending scene change if desired. For example, if you are on Scene 2 in Module A and you select Scene 8 for Module A, the message "2 -> 8" will be displayed next to the Module A label. The Scene Matrix and Control Surface immediately change to Scene 8, but internally the scene change has not yet occurred. You can reselect Scene 2 and thereby cancel the upcoming scene change.

Note that you can do this in any or all of the layers independently, and each layer will display a message indicating the upcoming scene change.

Note: if you have selected a scene change in advance, and it has not yet occurred, the Control Surface and various editing pages such as the KARMA GE Page 0-6 and the Control Surface RT/KARMA Page 0-9d will show the new scene's parameters. Editing them while the scene change is pending will actually be editing the upcoming scene, and you will not hear any changes until the scene change has actually occurred.

---

## ▼ 7-5: Page Menu Commands

The number before each command shows its ENTER + number-key shortcut. For more information on these shortcuts, see "ENTER + 0-9: shortcuts for menu commands" on page 147.

- **0: Write Combination.** For more information, see "Write Combination" on page 501.
- **1: Exclusive Solo.** For more information, see "Exclusive Solo" on page 147.
- **2: Copy KARMA Module.** For more information, see "Copy KARMA Module" on page 504.
- **3: Initialize KARMA Module.** For more information, see "Initialize KARMA Module" on page 505.
- **4: Copy Scene.** For more information, see "Copy Scene" on page 157.



- 5: **Swap Scene**. For more information, see “Swap Scene” on page 157.
- 6: **Capture Random Seed**. For more information, see “Capture Random Seed” on page 157.
- 7: **Copy From Program**. For more information, see “Copy From Program” on page 501.

## 7-6: Perf Real-Time Parameters

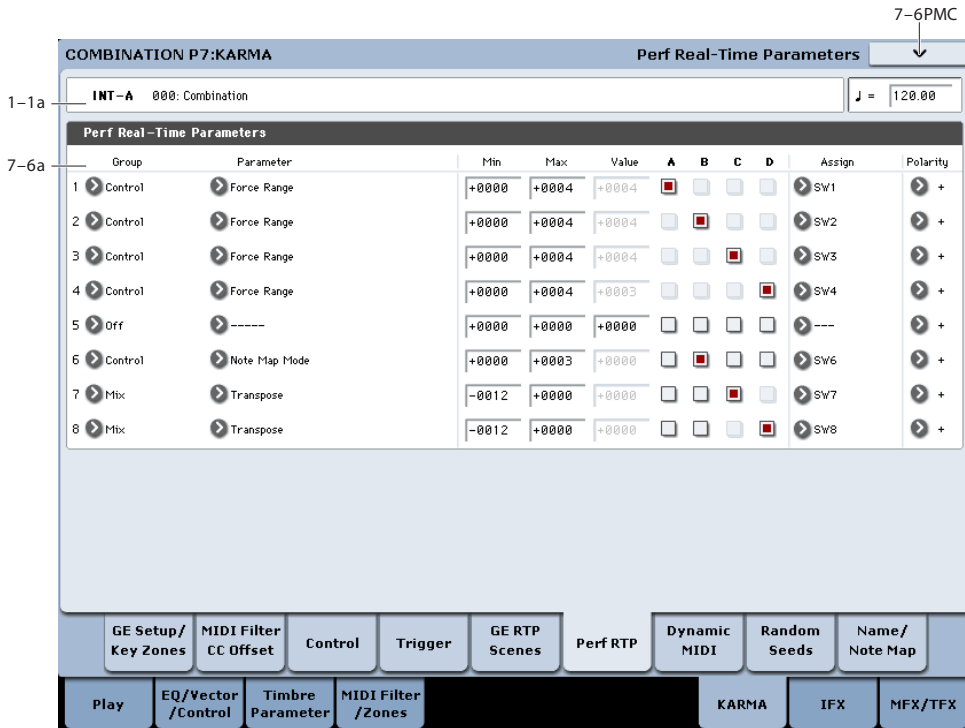

Here you can assign controllers to KARMA Performance Real-Time Parameters (Perf. RTP) outside of the GE Real-Time Parameters that control the internal settings of the GE. Examples include the KARMA Key Zone parameters (Combination 7-1b) and KARMA Control and Trigger parameters (Combination 7-3, 7-4).

For more information, please see “7-6: Perf Real-Time Parameters” on page 481.

### 7-6a: Perf Real-Time Parameters (1...8)

**Group** [Off, PE, Mix, Control, Trigger, Key Zones, Random Seeds]

**Parameter** [---, Time Signature... Retrigger Each Time]

**Min (Minimum Value)** [-8192...+8191]

**Max (Maximum Value)** [-8192...+8191]

**Value** [-8192...+8191]

For more information on these parameters, see “7-6b: Perf Real-Time Parameters” on page 123.

**A/B/C/D** [Off, On]

Specifies whether the Perf Real-Time Parameter settings will be valid for each Module.

**On (checked):** The Perf Real-Time Parameter settings will be valid.

**Off (unchecked):** The Perf Real-Time Parameter settings will be ignored.

**Assign** [---, Slider1...8, Slider1...8(SW), SW1...8, DynaMIDI1...8]

For more information, see “Assign” on page 124.

**Polarity** [+,-]

For more information, see “Polarity” on page 124.

**Group: PE (Performance)**

For more information, see “Group: PE (Performance)” on page 124.

**Group: Mix**

For more information, see “Group: Mix” on page 124.

**Run** [0000, 0001]

Assign the function of “Run” (0-6b).

+0000: Off

+0001: Run

Please see “Run” on page 422.

**Group: Control**

Please see “Group: Control” on page 124.

**Group: Trigger**

Please see “Group: Trigger” on page 125.

**Trigger By Module** [+0000...+0004]

Assign the function of “Trigger By Module” (7–4a).

- +0000: Off
- +0001: A
- +0002: B
- +0003: C
- +0004: D

Please see “Trigger By Module” on page 477.

**GE Phrase Length** [+0000...+0100]

Assign the function of “GE Phrase Length ” (7–4a).

Please see “GE Phrase Length” on page 477.

**Group: Key Zones**

For more information, see “Group: Zone” on page 126.

**Group: Random Seeds**

For more information, see “Group: Random” on page 126.

**7–6: Page Menu Commands**

The number before each command shows its ENTER + number-key shortcut. For more information on these shortcuts, see “ENTER + 0-9: shortcuts for menu commands” on page 147.

- **0: Write Combination.** For more information, see “Write Combination” on page 501.
- **1: Exclusive Solo.** For more information, see “Exclusive Solo” on page 147.
- **2: Copy KARMA Module.** For more information, see “Copy KARMA Module” on page 504.
- **3: Initialize KARMA Module.** For more information, see “Initialize KARMA Module” on page 505.
- **4: Copy Scene.** For more information, see “Copy Scene” on page 157.
- **5: Swap Scene.** For more information, see “Swap Scene” on page 157.
- **6: Capture Random Seed.** For more information, see “Capture Random Seed” on page 157.
- **7: Copy From Program.** For more information, see “Copy From Program” on page 501.

**7–7: Dynamic MIDI**

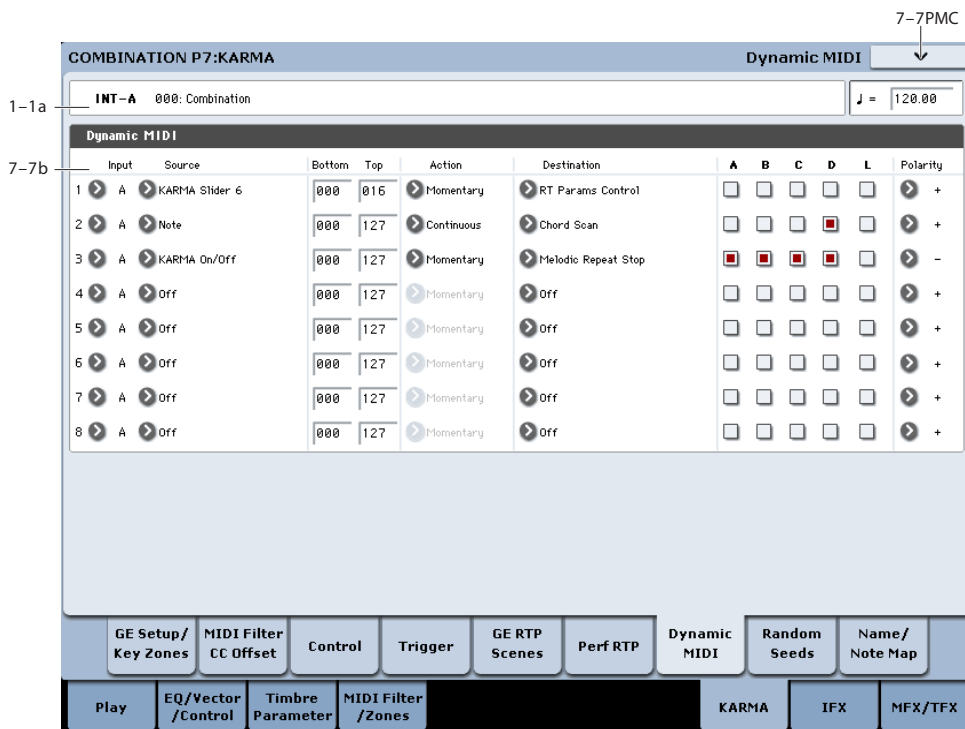

Dynamic MIDI is a function that lets you use the KRONOS’s controllers and MIDI control messages to modulate specific KARMA functions.

For more information, please see “7–7: Dynamic MIDI” on page 128.

**7–7a: Dynamic MIDI (1...8)**

**Input (Input Module)** [A...D]

Indicates either A, B, C, or D as the KARMA Module that will be the Dynamic MIDI Source input.

MIDI control data that matches the “Input Channel” (7-1d) of the KARMA Module that you select here will be used as the **Source**. If the **Source** is “Note In Zone” or “Note Out Zone,” the zone will be the key zone (7-1c) of the KARMA Module that you select here.

**Source** [Off, JS+Y #01...Vel Out Z]

For more information, see “Source” on page 128, and “Dynamic MIDI Sources & Destinations” on page 1109.

**Bottom (Range Bottom)** [000...127]

Please see “Bottom (Range Bottom)” on page 128.

**Top (Range Top)** [000...127]

For more information, see “Top (Range Top)” on page 128.

**Action (Range Action)** [M, T, C]

For more information, see “Action (Source Action)” on page 128.

**Destination** [Off, RT Params Control... Buffer Latch]

For more information, see “Destination” on page 129, and “Dynamic MIDI Sources & Destinations” on page 1109.

**A/B/C/D** [Off, On]

Specifies the Modules for which the Dynamic MIDI settings will be valid.

**On (checked):** The Dynamic MIDI settings will be valid.

**Off (unchecked):** The Dynamic MIDI settings will be ignored.

**L (Last Triggered)** [Off, On]

The Dynamic MIDI settings will be valid only for the last-triggered KARMA Module (A, B, C, or D). For example, this allows you to assign different Modules to be triggered from different parts of the keyboard, and depending on which one was last triggered, route a Dynamic MIDI effect to it, such as Direct Indexing.

**Polarity** [+ , - , +/- , -/+]

For more information, see “Polarity” on page 129.

- 5: **Swap Scene**. For more information, see “Swap Scene” on page 157.
- 6: **Capture Random Seed**. For more information, see “Capture Random Seed” on page 157.
- 7: **Copy From Program**. For more information, see “Copy From Program” on page 501.

## ▼ 7-7: Page Menu Commands

The number before each command shows its ENTER + number-key shortcut. For more information on these shortcuts, see “ENTER + 0-9: shortcuts for menu commands” on page 147.

- 0: **Write Combination**. For more information, see “Write Combination” on page 501.
- 1: **Exclusive Solo**. For more information, see “Exclusive Solo” on page 147.
- 2: **Copy KARMA Module**. For more information, see “Copy KARMA Module” on page 504.
- 3: **Initialize KARMA Module**. For more information, see “Initialize KARMA Module” on page 505.
- 4: **Copy Scene**. For more information, see “Copy Scene” on page 157.

## 7-8: Random Seeds

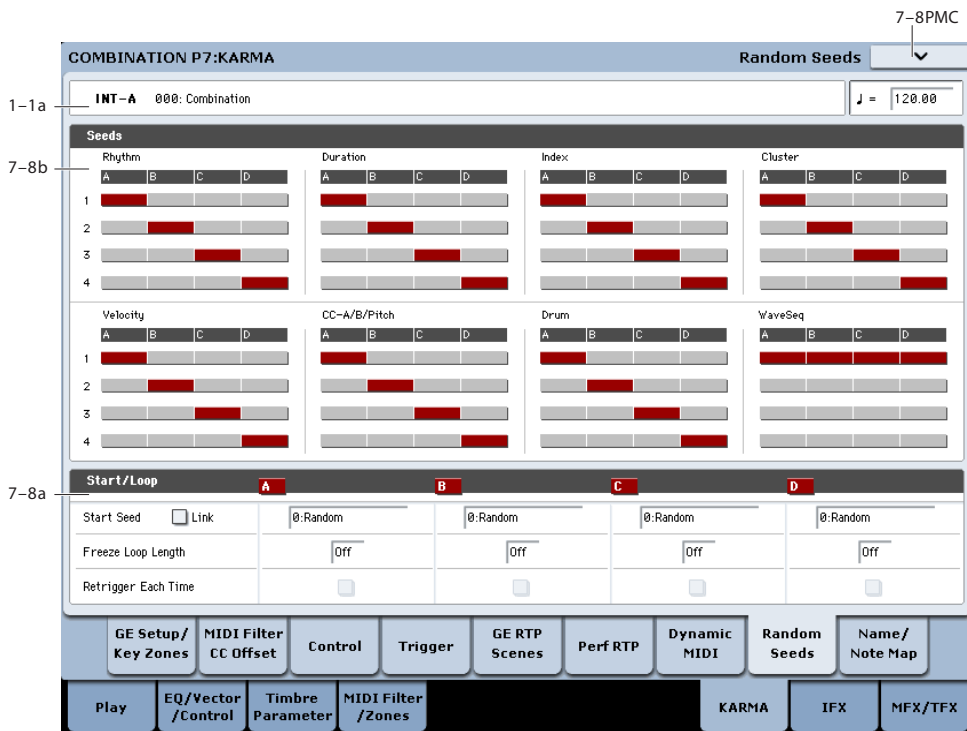

The Random Seeds page allows you to control some of the randomizable characteristics of a Module's GE. Different Modules using the same GE can have various randomizable characteristics "linked" so that they share the same start seeds, generating phrases with the same characteristics.

For more information, please see "7-8: Random Seeds" on page 129.

### 7-8a: Seed

#### Rhythm (Rhythm Seed)

- A** [1, 2, 3, 4]
- B** [1, 2, 3, 4]
- C** [1, 2, 3, 4]
- D** [1, 2, 3, 4]

Allows you to share the same random rhythm characteristics between modules using the same GE. For the GE selected for each KARMA Module, you can often control the degree of randomness for various parameter groups such as rhythm, duration, velocity etc. The random calculations are performed based on initial starting values, known as "seeds."

For example, if you select Rhythm Seed 1 for all four KARMA Modules, running the same GE under the same conditions will cause the randomness of the rhythms to be identical. If many types of randomness are being used, such as duration, velocity etc., setting all the seeds to the same value within each group will cause the resulting phrases to be identical.

Conversely, if you select Rhythm Seed 1, 2, 3, and 4 respectively for the four KARMA Modules and run the same GE under the same conditions, the randomness of the rhythms will be different. If many types of randomness are being used, such as duration, velocity etc., setting all the seeds to the different values within each group will cause the resulting phrases to be completely different.

Normally, you will select different values, such as A: 1, B: 2, C: 3, D: 4.

Select identical values if you want two or more KARMA Modules to play the same randomizable GE in unison or harmony with the same randomizations.

 Changing these settings will not have any effect for GEs that were not designed to utilize various random capabilities.

#### Duration (Duration Seed)

Controls the randomizable characteristics for the Duration Group, similar to those explained under "Rhythm (Rhythm Seed)" above. For more information, see "Duration Group" on page 1040.

#### Index (Index Seed)

Controls the randomizable characteristics for the Index Group, similar to those explained under "Rhythm (Rhythm Seed)" above. For more information, see "Index Group" on page 1043.

#### Cluster (Cluster Seed)

Controls the randomizable characteristics for the Cluster Group, similar to those explained under "Rhythm (Rhythm Seed)" above. For more information, see "Cluster Group" on page 1047.

**Velocity (Velocity Seed)**

Controls the randomizable characteristics for the Velocity Group, similar to those explained under “Rhythm (Rhythm Seed)” above. For more information, see “Velocity Group” on page 1049.

**CC–A/B (CC–A/B Seed)**

Controls the randomizable characteristics for the CCs/Pitch Group, similar to those explained under “Rhythm (Rhythm Seed)” above. For more information, see “CCs/Pitch Group” on page 1052.

**Drum (Drum Seed)**

Controls the randomizable characteristics for the Drum Group, similar to those explained under “Rhythm (Rhythm Seed)” above. For more information, see “Drum Group” on page 1073.

**WaveSeq (WaveSeq Seed)**

Controls the randomizable characteristics for the WaveSeq Group, similar to those explained under “Rhythm (Rhythm Seed)” above. For more information, see “WaveSeq Group” on page 1056.

- 5: **Swap Scene**. For more information, see “Swap Scene” on page 157.
- 6: **Capture Random Seed**. For more information, see “Capture Random Seed” on page 157.
- 7: **Copy From Program**. For more information, see “Copy From Program” on page 501.

---

**7–8b: Start/Loop**

**Link to Start Seed** [Off, On]

If turned On, when you specify a “Start Seed” value for one of the active KARMA Modules, the “Start Seed” of all other active Modules in the Performance will be set to the same value.

This is useful for quickly trying out new settings on all Modules at the same time.

 This setting is ignored while “Random Capture” is being executed.

**Start Seed** [-2147483648...0: Random...+2147483647]

**Freeze Loop Length** [Off, 01...32]

**Retrigger Each Time** [Off, On]

Please see “7–8b: Start” on page 130.

---

**▼ 7–8: Page Menu Commands**

The number before each command shows its ENTER + number-key shortcut. For more information on these shortcuts, see “ENTER + 0-9: shortcuts for menu commands” on page 147.

- 0: **Write Combination**. For more information, see “Write Combination” on page 501.
- 1: **Exclusive Solo**. For more information, see “Exclusive Solo” on page 147.
- 2: **Copy KARMA Module**. For more information, see “Copy KARMA Module” on page 504.
- 3: **Initialize KARMA Module**. For more information, see “Initialize KARMA Module” on page 505.
- 4: **Copy Scene**. For more information, see “Copy Scene” on page 157.

## 7-9: Name/Note Map

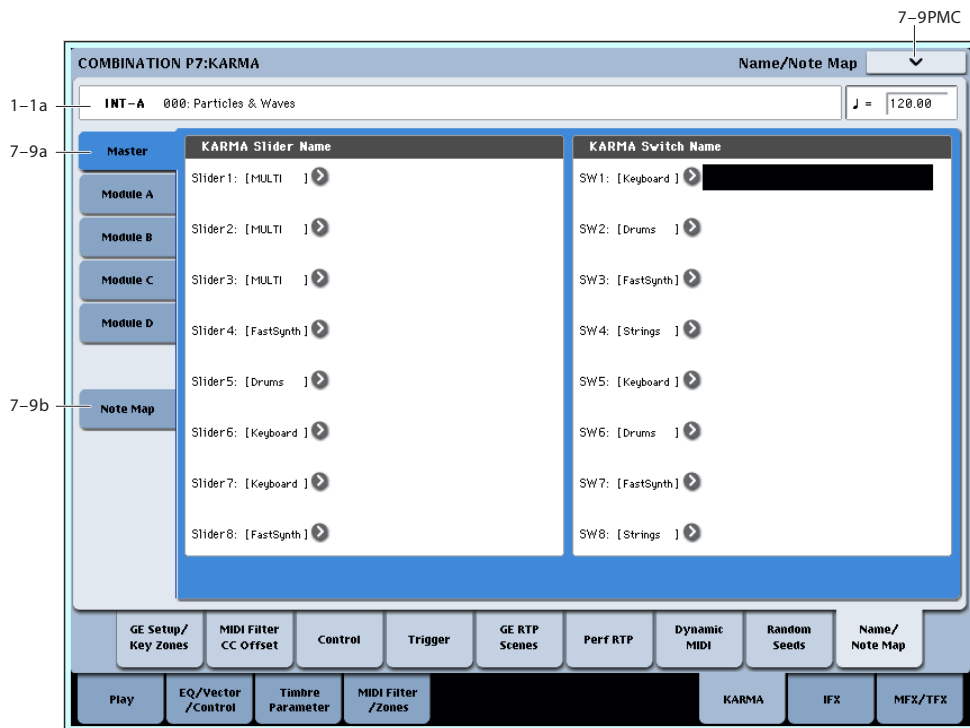

Here you can assign the names for KARMA SLIDERS 1-8 and KARMA SWITCHES 1-8, view Global Note Map Tables, and edit the Custom Note Map Table stored with the Combi.

### 7-9a: Name

Each Module Control layer has its own set of names for the 8 KARMA SLIDERS and 8 KARMA SWITCHES. For more information, see "7-9b: Module A" on page 132.

#### Master, Module A...D

**Slider1...8** [000 (no name)... 571 Waveform Select [16]]

**Switch1...8** [000 (no name)... 571 Waveform Select [16]]

### 7-9b: Note Map

**Table** [Custom, sidestick/rides1...maj7->oct]

**Note In** [C-1...G9]

**Note Out** [Remove, C-1...G9]

**Octave Replicate** [Off, On]

#### Reset button

For more information, see "7-9b: Note Map" on page 486.

### 7-9b: Note Map (Custom)

**Table** [Custom, Global 1...64]

**In (Note In)** [C-1...G9]

**Out (Note Out)** [Remove, C-1...G9]

#### Table Grid

**Octave Replicate** [Off, On]

#### Reset

For details, see "7-9c: Note Map" on page 132.

**Display Module** [A, B, C, D]

Here you can select the KARMA module that you want to edit, and view the Note Map Table.

Note Map display

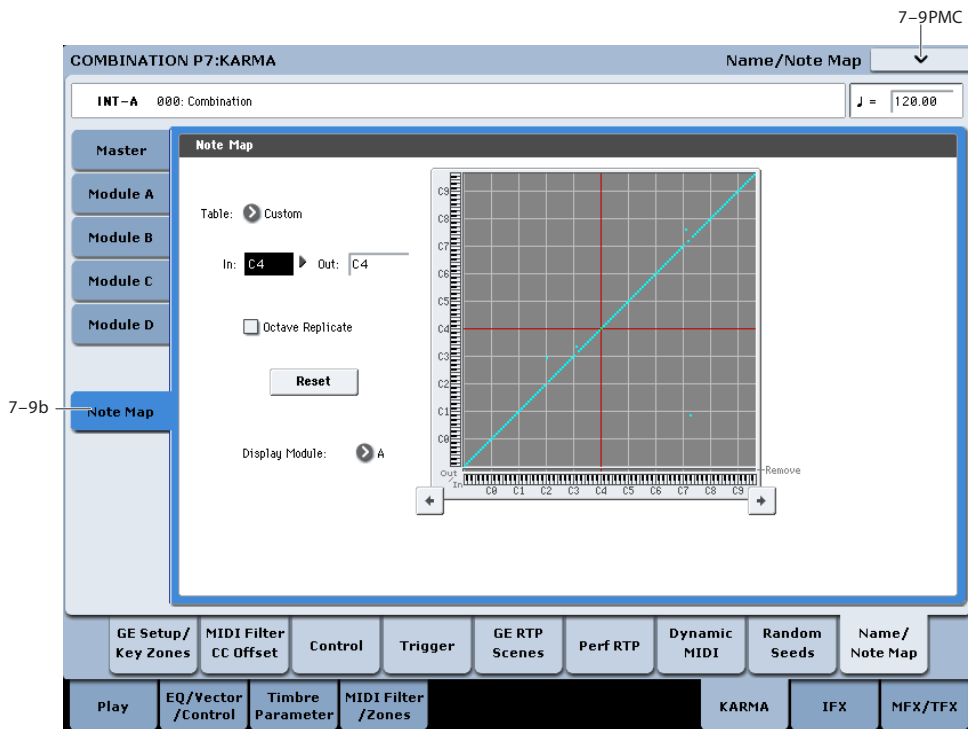

▼ 7-9: Page Menu Commands

The number before each command shows its ENTER + number-key shortcut. For more information on these shortcuts, see “ENTER + 0-9: shortcuts for menu commands” on page 147.

- 0: **Write Combination.** For more information, see “Write Combination” on page 501.
- 1: **Exclusive Solo.** For more information, see “Exclusive Solo” on page 147.
- 2: **Copy KARMA Module.** For more information, see “Copy KARMA Module” on page 504.
- 3: **Initialize KARMA Module.** For more information, see “Initialize KARMA Module” on page 505.
- 4: **Copy Scene.** For more information, see “Copy Scene” on page 157.
- 5: **Swap Scene.** For more information, see “Swap Scene” on page 157.
- 6: **Capture Random Seed.** For more information, see “Capture Random Seed” on page 157.
- 7: **Auto Assign KARMA RTC Name.** For more information, see “Auto Assign KARMA RTC Name” on page 506.
- 8: **Copy From Program.** For more information, see “Copy From Program” on page 501.
- 9: **Copy Note Map.** For more information, see “Copy Note Map” on page 148.



## Combination P8: Insert Effect

You can also specify the bus routing for the program used by each timbre 1–16. For instance, you can:

- Send the output of a timbre to an insert effect
- Route a sound to an insert effect

- Make detailed settings for insert effects
- Make common LFO settings for effects

For more details on the Insert Effects, see the “Effect Guide” on page 857.

### 8–1: Routing1

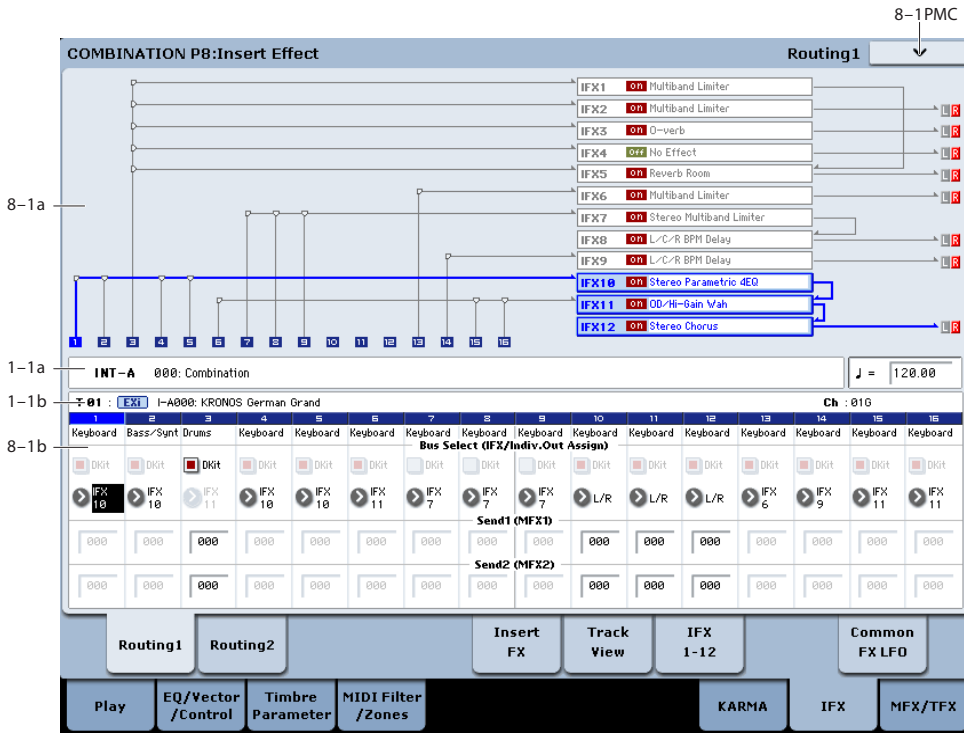

Specifies the bus to which the program oscillator(s) used by each timbre 1–16 will be sent. You can also set the send levels to the master effects from this page.

effect. The type of insert effect, the on/off status, and the chain settings can be edited in the P8– Insert FX page.

### 8–1a: Routing Map

This shows the status of the insert effects.

This area shows the insert effect routing (Bus Select), the name of the assigned effect, the on/off status, chaining, and the output bus that follows the insert

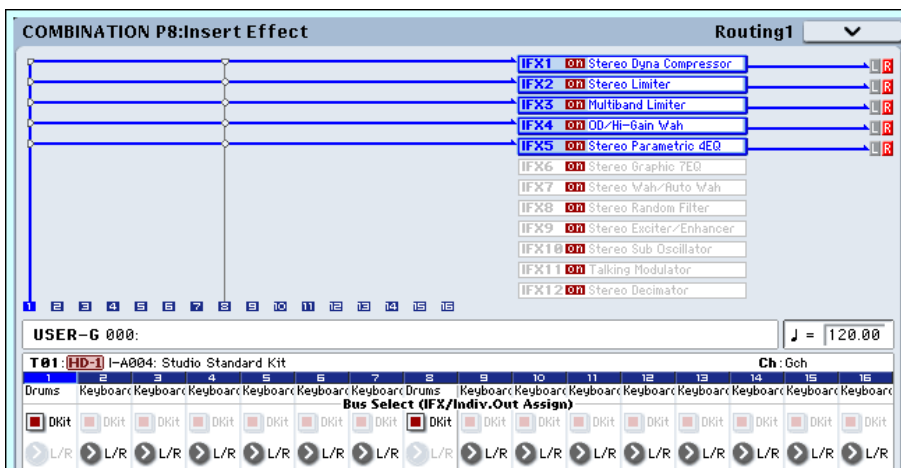

## 8-1b: Routing1

### Timbre 01 (Timbre Number)

#### Bus Select (IFX/Indiv. Out Assign) Dkit [Off, On]

You can select this only if the Timbre's Program is a drum program (Oscillator Mode Drums). This parameter can also be edited from the P8- Routing 2 page.

**On (checked):** The Bus Select, FX Control Bus, Send1, and Send2 settings for each key of the selected drum kit will be used. Check this setting if you want to apply an individual insert effect to each drum instrument, or to send individual drum instruments to AUDIO OUTPUT (INDIVIDUAL).

*Tip:* In most preloaded drumkits, the drum instruments have the same Bus Select settings according to their type, as follows.

Snares → IFX1

Kicks → IFX2

Toms → IFX3

Cymbals → IFX4

Percussion, etc. → IFX5

If you want to edit these routings, use the **Drum Kit IFX Patch** page menu command.

**Off (unchecked):** The Bus Select, FX Control Bus, and Send 1/2 settings will be used. All drum instruments will be sent to the specified bus.

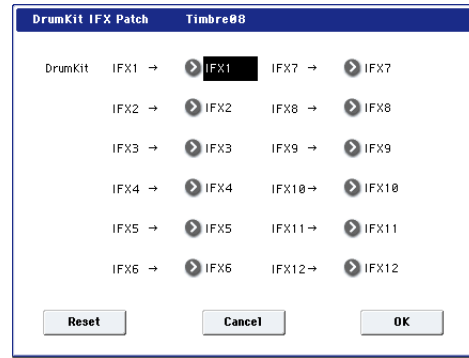

#### Bus Select (IFX/Indiv.Out Assign)

[L/R, IFX1...12, 1...4, 1/2...3/4, Off]

This specifies the output bus for the timbre's program oscillator. This parameter can also be edited from the P8- Routing 2 page.

**L/R:** Output to the L/R bus.

**IFX1...12:** Output to the IFX1-12 buses.

**1...4:** The timbre will be sent in mono to the corresponding Individual output.

**1/2, 3/4:** The timbre will be output in stereo according to its pan setting from the corresponding AUDIO OUTPUT (INDIVIDUAL) pairs 1/2, 3/4.

**Off:** The timbre will not be output from the L/R bus, IFX1-12 buses, or Individual 1-4 buses. Choose the Off setting if you want the program oscillator output of the timbre to be connected in series to a master effect. Use Send1 (to MFX1) and Send2 (to MFX2) to specify the send levels.

*Tip:* You can create a wide variety of routings by using each timbre's Bus Select and the Chain to and Chain settings (5-5a) that follow the insert effect.

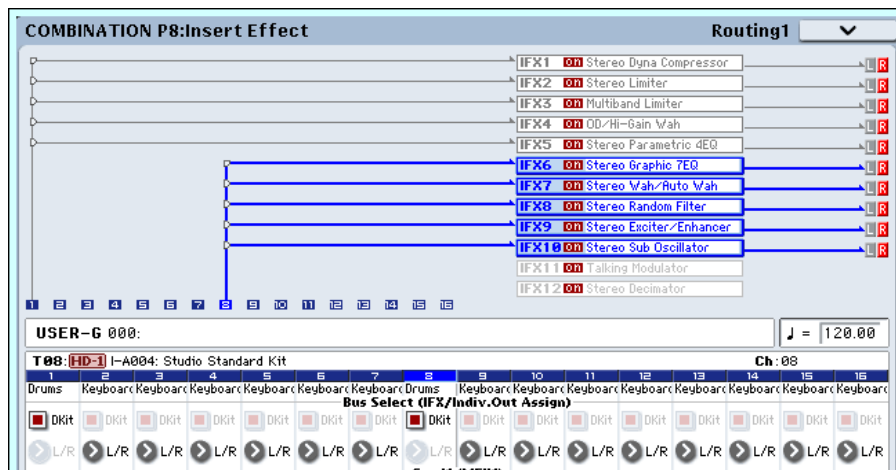

Example: Inserting a single IFX into multiple timbre

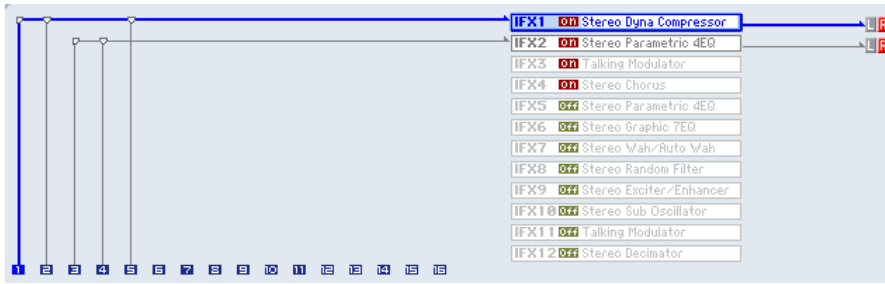

Example: Inserting a separate IFX into each timbre, and then inserting an IFX at the final stage

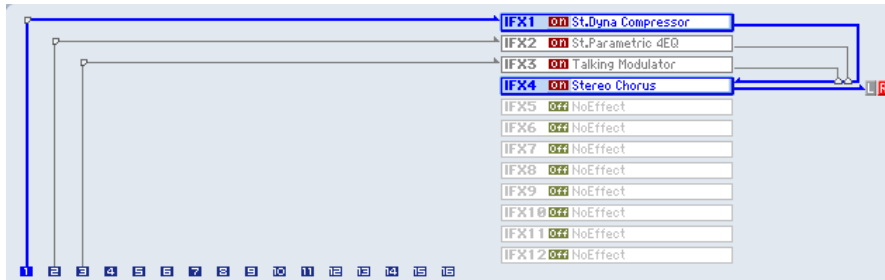

Example: Sharing a portion of a timbre's IFX chain with another timbre



**Send1 (MFX1)** [000...127]

**Send2 (MFX2)** [000...127]

For each timbre, these parameters set the send level to master effects 1 and 2. These settings are valid when **Bus Select** is set to L/R or Off. When IFX 1–12 are selected, the send levels to master effects 1 and 2 are set by the **Send1** and **Send2** parameters of the Insert FX page, after the sound has passed through IFX1–12.

If **Bus Select** is set to 1...4 or 1/2...3/4, these settings are ignored.

**MIDI** Control change CC#93 can be used to control the Send 1 level, and CC#91 to control the Send 2, and modify their respective settings. These messages will be received on the MIDI channel specified for each timbre in the P2: MIDI channel page.

The actual send levels are determined by multiplying this value with the send level **Send1** and **Send2** (Program 8–1f, 8–5b) for each oscillator of the program selected for the timbre.

**Timbre 02...16 (Timbre Number)**

These settings specify the program oscillator output bus and master effect send levels for timbres 2 through 16. They are the same as for timbre 1. See “Timbre 01”.

*Note:* You can use the control surface to control Send1 and Send2. These can also be controlled from the mixer section of the front panel, or from the P0– Control Surface page of the LCD screen. Here’s the procedure for editing these settings from the front panel.

1. Press the **CONTROL ASSIGN MIXER TIMBRE/TRACK** switch to select either timbres 1–8 or 9–16.
2. Press the **MIXER KNOBS** switch to select **CHANNEL STRIP**.
3. Use the **MIXER SELECT 1/9–8/16** switches to select the timbre whose send levels you want to adjust.
4. Use **MIX CHANNEL STRIP “FX SEND 1”** (knob 7) and **“FX SEND 2”** (knob 8) to control the send levels.

If **Bus Select (IFX/Indiv. Out Assign)** is set to L/R or OFF, this will control **OSC1 Send1 (to MFX1)–OSC2 Send2 (to MFX2)**. If **Bus Select (IFX/Indiv. Out Assign)** is set to IFX1–12, this will control **Send1 and Send2 (P8– Insert FX page)**.

**▼ 8–1: Page Menu Commands**

The number before each command shows its **ENTER + number-key** shortcut. For more information on these shortcuts, see “**ENTER + 0-9: shortcuts for menu commands**” on page 147.

- **0: Write Combination.** For more information, see “**Write Combination**” on page 501.

- 1: **Exclusive Solo.** For more information, see “Exclusive Solo” on page 147.
- 2: **Copy Insert Effect.** For more information, see “Copy Insert Effect” on page 159.
- 3: **Swap Insert Effect.** For more information, see “Swap Insert Effect” on page 159.
- 4: **Drum Kit IFX Patch.** For more information, see “Drum Kit IFX Patch” on page 506.

## 8-2: Routing2

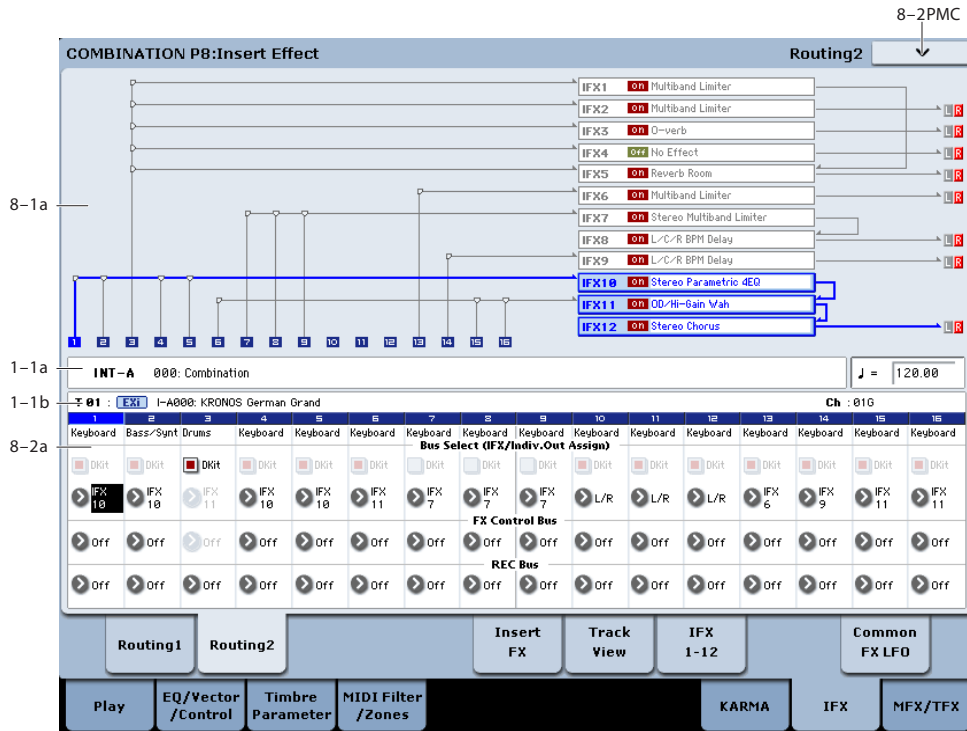

Here you can specify the program oscillator output bus, effect control bus, and REC bus for each timbre 1 through 16.

### 8-2a: Routing2

#### Timbre 01 (Timbre Number)

#### Bus Select (IFX/Indiv. Out Assign) Dkit [Off, On]

You can select this only if the specified program is a drum program (Oscillator Mode Drums). These settings can also be made in the Insert Effect-Routing1. For more information, please see “Bus Select (IFX/Indiv. Out Assign) Dkit” on page 489.

#### Bus Select (IFX/Indiv.Out Assign) [L/R, IFX1...12, 1...4, 1/2...3/4, Off]

For each timbre, these parameters specify the bus to which the program oscillator(s) will be sent. The current settings can also be viewed in the Routing Map. This parameter can also be edited from the P8-Routing1 page. For more information, please see “Bus Select (IFX/Indiv.Out Assign)” on page 489.

#### FX Control Bus [Off, 1, 2]

Sends the output of the timbre to an FX Control bus (two-channel stereo FX Ctrl 1 or 2).

Use the FX Control buses when you want a separate sound to control the audio input of an effect. You can use two FX Control buses (each is a two-channel stereo bus) to control effects in various ways.

For more information, please see “FX Control Buses” on page 860.

#### REC Bus (All OSCs to) [Off, 1...4, 1/2, 3/4]

These settings send the output of the timbre to the REC buses (four mono channels: 1, 2, 3, 4).

The REC buses are dedicated internal buses for recording, used for sampling in the various modes or for recording audio tracks in Sequencer mode.

In Combination mode, you can resample your keyboard or KARMA performance, or sample an external audio signal from the Audio Inputs.

Normally you will set **Source Bus** (0-8c) to L/R, so that you can sample the signal of the L/R bus line, such as your keyboard or KARMA performance. However, you can use a REC bus if you want to sample only an audio input while performing on the keyboard or KARMA function which are being output via L and R. If desired, multiple audio inputs can be mixed to a REC bus, or the direct signal from an audio input can be mixed to a REC bus along with the sound from an insert effect and sampled. Alternatively, you can resample the keyboard performance of only specific timbres. For more information, see the diagram “Source Bus = REC Bus 1/2” on page 18.

**Off:** The signal will not be sent to a REC bus. Normally you will leave this off.

**1...4:** The output of the timbre will be sent to the corresponding REC bus. The **Pan** setting (0–1b) of each timbre will be ignored, and the signal will be sent in monaural.

**1/2, 3/4:** The output of the timbre will be sent in stereo to the corresponding pair of REC buses. The signal is sent in stereo to REC buses 1/2 or 3/4 according to the **Pan** setting (0–1b) of each timbre.

**Timbre 02...16 (Timbre Number)**

These settings specify the program oscillator output bus, effect control bus, and REC bus used by timbres 2 through 16. These are the same as for timbre 1. See “Timbre 01”.

▼ **8–2: Page Menu Commands**

The number before each command shows its ENTER + number-key shortcut. For more information on these shortcuts, see “ENTER + 0-9: shortcuts for menu commands” on page 147.

- **0: Write Combination.** For more information, see “Write Combination” on page 501.
- **1: Exclusive Solo.** For more information, see “Exclusive Solo” on page 147.
- **2: Copy Insert Effect.** For more information, see “Copy Insert Effect” on page 159.
- **3: Swap Insert Effect.** For more information, see “Swap Insert Effect” on page 159.
- **4: Drum Kit IFX Patch.** For more information, see “Drum Kit IFX Patch” on page 506.

**8–5: Insert FX**

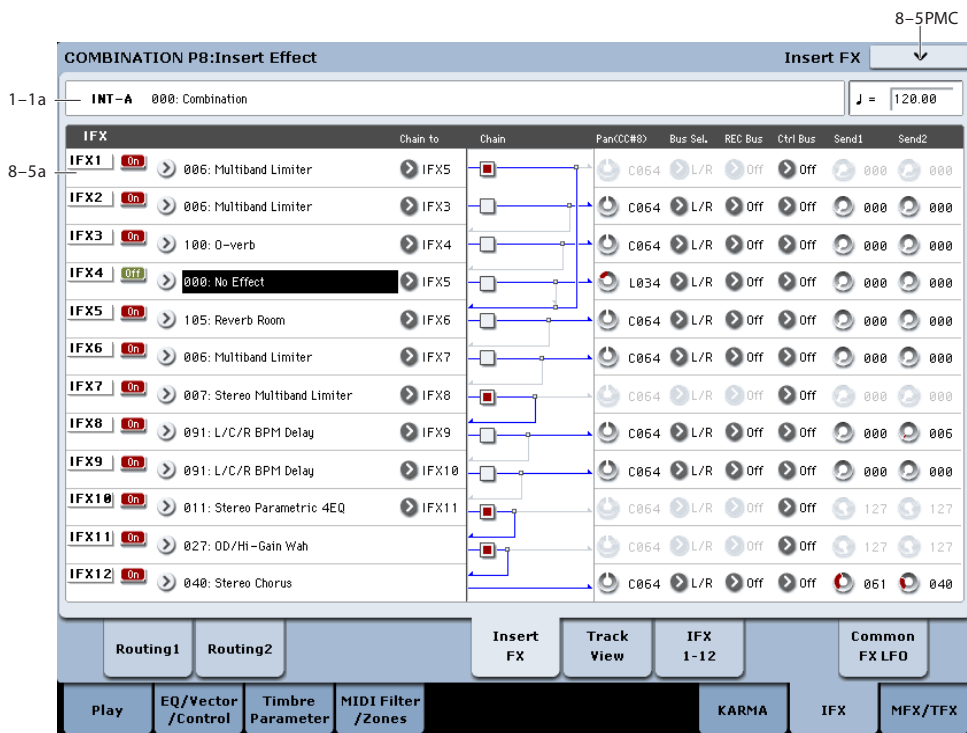

**8–5a: IFX**

Here you can choose the type of each insert effect 1 through 12, its on/off status, chaining, and adjust the post-IFX mixer settings. For insert effects, the direct sound (Dry) is always stereo-in and out. The input/output configuration of the effect sound (Wet) depends on the effect type.

For detailed explanations of the individual effects, please see the “Effect Guide” on page 857.

The following parameters are the same as in Program mode. For more information, please see “8–5a: IFX” on page 137.

However, unlike in Program mode, you can use a different MIDI channel to modulate each effect, if desired. This includes the post-IFX **Pan (CC#8)**, **Send1**, and **Send2** settings, as well as the effect’s dynamic modulation (Dmod). To set the MIDI channel, use the **Ch** parameter on the IFX 1-12 page (8–7a).

**IFX1**

For detailed information on these parameters, see “8–5a: IFX” on page 137.

<b>IFX1</b>	<b>[000...185]</b>
<b>IFX1 On/Off</b>	<b>[Off, On]</b>
<b>Chain to</b>	<b>[IFX2...IFX12]</b>
<b>Chain</b>	<b>[Off, On]</b>
<b>Pan(CC#8) (Post IFX Pan)</b>	<b>[L000...C064...R127]</b>
<b>Bus Sel. (Bus Select)</b>	<b>[L/R, 1...4, 1/2...3/4, Off]</b>
<b>Ctrl Bus (FX Control Bus)</b>	<b>[Off, 1, 2]</b>
<b>REC Bus</b>	<b>[Off, 1...4, 1/2, 3/4]</b>
<b>Send1</b>	<b>[000...127]</b>
<b>Send2</b>	<b>[000...127]</b>

- 6: **Clean Up IFX Routings.** For more information, see “Clean Up IFX Routings” on page 162.

*Note:* You can use the control surface to control Send 1 and 2. See “Send1 (MFx1)” on page 490.

### **IFX2...12**

These parameters specify the type of each insert effect, its on/off status, chaining, and post-IFX mixer settings. With the exception of **Chain to** and **Chain**, the parameters are the same as for IFX1. For more information, please see “IFX1” on page 137.

<b>IFX2: Chain to</b>	<b>[IFX3...IFX12]</b>
<b>IFX3: Chain to</b>	<b>[IFX4...IFX12]</b>
<b>IFX4: Chain to</b>	<b>[IFX5...IFX12]</b>
<b>IFX5: Chain to</b>	<b>[IFX6...IFX12]</b>
<b>IFX6: Chain to</b>	<b>[IFX7...IFX12]</b>
<b>IFX7: Chain to</b>	<b>[IFX8...IFX12]</b>
<b>IFX8: Chain to</b>	<b>[IFX9...IFX12]</b>
<b>IFX9: Chain to</b>	<b>[IFX10...IFX12]</b>
<b>IFX10: Chain to</b>	<b>[IFX11...IFX12]</b>
<b>IFX11: Chain to</b>	<b>[IFX12]</b>

### ▼ **8-5: Page Menu Commands**

The number before each command shows its ENTER + number-key shortcut. For more information on these shortcuts, see “ENTER + 0-9: shortcuts for menu commands” on page 147.

- 0: **Write Combination.** For more information, see “Write Combination” on page 501.
- 1: **Exclusive Solo.** For more information, see “Exclusive Solo” on page 147.
- 2: **Copy Insert Effect.** For more information, see “Copy Insert Effect” on page 159.
- 3: **Swap Insert Effect.** For more information, see “Swap Insert Effect” on page 159.
- 4: **Insert IFX Slot.** For more information, see “Insert IFX Slot” on page 160.
- 5: **Cut IFX Slot.** For more information, see “Cut IFX Slot” on page 161.

## 8-6: Track View

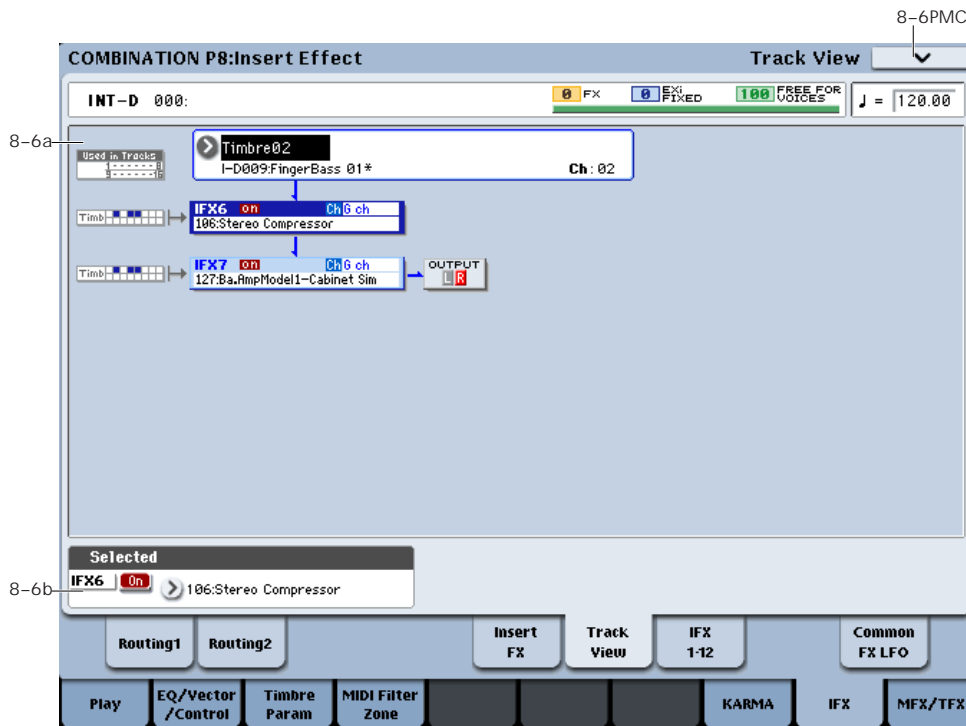

### 8-6a: Track View

Here you can view the timbre output and insert effect routing.

#### Used in Tracks

The upper and lower rows of boxes with eight boxes in each row indicate the timbre that is being sent to the corresponding insert effect. (The eight upper boxes correspond to timbres 1-8, and the eight lower boxes correspond to timbres 9-16.)

In this example you can see that IFX7 and 8 are being used by timbres 6 and 7, as well as by timbre 1. So, any changes to these effects will affect all three timbres.

#### Timbre Select [Timbre 01...Timbre 16]

Here you can select the timbre that will be shown in the Track View screen.

The lower line shows the program name and MIDI channel of the timbre.

The screen shows the insert effect(s) used by the selected timbre.

#### Slot [IFX1...IFX12]

This indicates the slot number, effect type, effect on/off status, and control channel for the chained insert effects.

The selected slot is shown in dark blue. In the "Selected" area below, you can specify the "Effect Type" and "On/Off" status of the selected effect slot. This is also the effect slot that will be affected by the page menu commands "Insert IFX Slot" and "Cut IFX Slot."

When you move from this page to the P8- IFX1-12 page, the IFX you selected here will be selected.

For example if you select Timbre 03, only the insert effects used by timbre 3 will be shown.

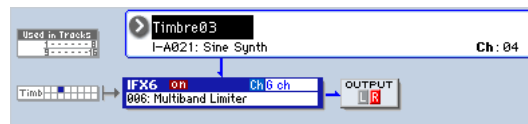

"OUTPUT" indicates the Bus Select settings that follow the insert effect. This tells you the output destination to which the audio signal will be sent.

### 8-6b: Selected

Here you can specify the "Effect Type" and "On/Off" status of the insert effect slot selected by Track Select. ("8-6a: Track View," above)

### ▼ 8-6: Page Menu Commands

The number before each command shows its ENTER + number-key shortcut. For more information on these shortcuts, see "ENTER + 0-9: shortcuts for menu commands" on page 147.

- 0: **Write Combination.** For more information, see "Write Combination" on page 501.
- 1: **Exclusive Solo.** For more information, see "Exclusive Solo" on page 147.
- 2: **Copy Insert Effect.** For more information, see "Copy Insert Effect" on page 159.
- 3: **Swap Insert Effect.** For more information, see "Swap Insert Effect" on page 159.



- 4: **Insert IFX Slot.** For more information, see “Insert IFX Slot” on page 160.
- 5: **Cut IFX Slot.** For more information, see “Cut IFX Slot” on page 161.
- 6: **Clean Up IFX Routings.** For more information, see “Clean Up IFX Routings” on page 162.

## 8-7: IFX 1-12

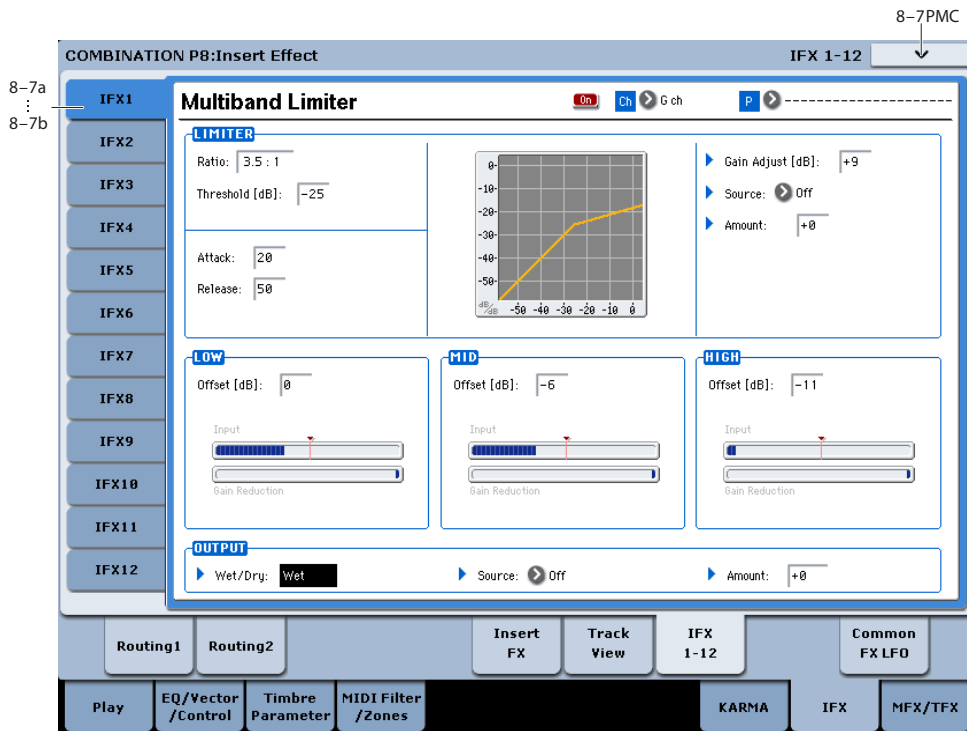

This page lets you edit the detailed parameters of the twelve insert effect s. Use the tabs at left to select IFX1 through IFX12.

To select different effects types, use the Insert FX or Track View pages. For more information, see “8-5: Insert FX” on page 492 and “8-6: Track View” on page 494.

### Effects Modulation: Dmod

Most effects have one or more parameters which can be modulated in realtime. In the KRONOS, this is called Dynamic Modulation, or Dmod for short.

For a complete list of Dmod sources, see “Dynamic Modulation Source List” on page 1101.

**MIDI** You can use different MIDI channels to control Dmod for each effect, if desired, as selected by the **Ch (Control Channel)** parameter.

### 8-7a: IFX1

**IFX1 On/Off**

[Off, On]



Turns the insert effect on/off. This is linked with the on/off setting in the P8- Insert FX page.

### Ch (Control Channel) [Ch01...16, G ch, All Routed]



This parameter specifies the MIDI channel that will be used to control effect dynamic modulation (Dmod), pan following the insert effect (CC#8), Send 1, and Send 2.

The channel number of the timbre routed through this IFX will be followed by a “\*” displayed at the right of Ch01-16. If two or timbres with different MIDI channel settings are routed through the same IFX, this parameter specifies which of these channels will be used to control the effect.

**G ch:** The global **MIDI Channel** (Global 1-1a) will be used to control the effect. Normally you will set this to G ch.

**All Routed:** The channel of any timbre routed through this effect can be used to control the effect. (Channels of each routed timbre will be indicated by “\*”).

### Drum Kits and the MIDI Control Channel

If a Timbre is using a Drum Kit, and the Timbre’s **Bus Select (IFX/Indiv. Out Assign) DKit** (8-1b) is enabled, this effects the MIDI Control Channel as well. In this case, the Timbre’s MIDI channel will be used to control any effect whose **Ch** is set to All Routed, regardless of the **Bus Select** (Global 5-3b) settings or the settings of the **DrumKit IFX Patch** page menu command.

### **P (Effect Preset) [P00, P01...15, U00...15, -----]**



Effect Presets let you easily store and recall all of the settings for an individual effect. You can store up to 16 user presets for each effect type, in addition to 15 re-writable factory presets.

The same presets appear in all of the modes (Program, Combi, Sequence, and Sampling), and sets of presets can be saved to and loaded from disk.

Note that edits to effects parameters are automatically stored with the Combi—you don't need to store them as an Effect Preset. Presets just make it easier to re-use your favorite settings.

For instance, you can save an Effect Preset while working on a particular Combi, and then later use the same Effect Preset in a different Program, Combi, or Song.

**P00: Initial Set:** These are the default settings that are recalled when you select an effect type in the Insert FX page. You can't save your own settings here.

**P01...P15:** These contain Korg preset data. We recommend that you store your settings in U00–U15.

**U00...U15:** These are areas in which you can store your own settings.

-----: This shows that no Effect Preset has been selected. You'll see this if you've just selected an effect, written a program, or selected a new Combi. Selecting this setting from the menu will not have any effect.

**Note:** Combis save the effects parameter settings, but they don't save the number of the selected Effect Preset. If you select an Effect Preset, and then save the Combi, the Effect Preset setting will revert to "-----".

For more details, see "Using Effect Presets" on page 141.

### **IFX1 Parameters**

Here you can set the effect parameters of the insert effect you chose in the P8– Insert FX page.

For more details, please see "Insert Effects (IFX1...IFX12)" on page 864.

---

### **8-7b: IFX2...12**

Here you can set the effect parameters of the insert effects selected in the Insert FX page.

The parameters for IFX2 through IFX12 are the same as for IFX1. For more information, please see "8-7a: IFX1" on page 495.

---

### **▼ 8-7: Page Menu commands**

The number before each command shows its ENTER + number-key shortcut. For more information on these shortcuts, see "ENTER + 0-9: shortcuts for menu commands" on page 147.

- **0: Write Combination.** For more information, see "Write Combination" on page 501.
- **1: Exclusive Solo.** For more information, see "Exclusive Solo" on page 147.

- **2: Copy Insert Effect.** For more information, see "Copy Insert Effect" on page 159.
- **3: Swap Insert Effect.** For more information, see "Swap Insert Effect" on page 159.
- **4: Write FX Preset.** For more information, see "Write FX Preset" on page 163.

## 8–9: Common FX LFO

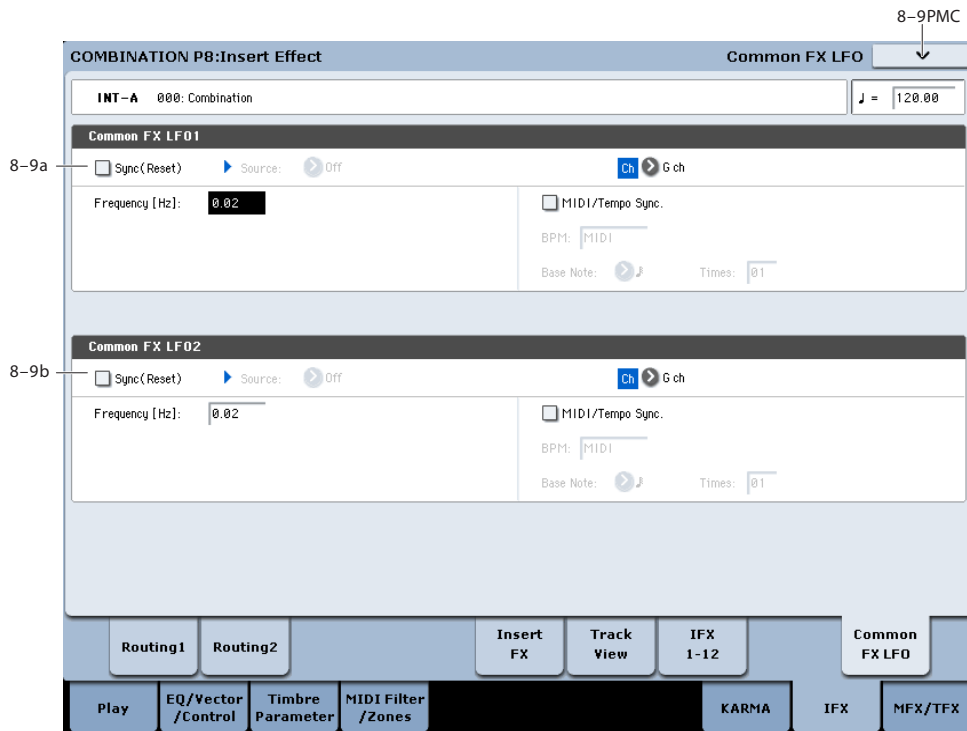

The two Common FX LFOs allow you to synchronize LFO-based modulation for multiple effects, such as phasers, flangers, filters, and so on.

The Common LFOs control only the frequency, MIDI synchronization, and reset options; each individual effect still has its own settings for the LFO waveform and phase.

Within the individual effects, you can choose whether to use one of the Common LFOs, or to use the individual effect’s frequency, sync, and/or reset settings instead. This is done via the effect’s **LFO Type** parameter; select **Individual** to use the effect’s settings, or **Common 1** or **2** to use the Common LFOs.

### 8–9a: Common FX LFO1

**Ch (Control Channel)** [Ch01...Ch16, G ch]

Specifies the MIDI channel that will control dynamic modulation (Dmod) for Common LFO 1 and 2.

**G ch:** The global MIDI channel will be used for control. This is the default.

**Sync (Reset)** [Off, On]

**Source (Dmod Source)** [List of Dmod Sources]

**Frequency** [0.02...20.00 Hz]

**MIDI/Tempo Sync** [Off, On]

**BPM** [MIDI, 040.00...300.00]

**Base Note** [♫...♫]

**Times** [01...32]

These parameters are the same as in Program mode. For details, see “8–9a: Common FX LFO1” on page 142.

### 8–9b: Common FX LFO2

These parameters are the same as for Common FX LFO1. For more information, please see “8–9a: Common FX LFO1” on page 142.

### ▼ 8–9: Page Menu Commands

The number before each command shows its ENTER + number-key shortcut. For more information on these shortcuts, see “ENTER + 0-9: shortcuts for menu commands” on page 147.

- 0: **Write Combination.** For more information, see “Write Combination” on page 501.
- 1: **Exclusive Solo.** For more information, see “Exclusive Solo” on page 147.
- 2: **Copy Insert Effect.** For more information, see “Copy Insert Effect” on page 159.
- 3: **Swap Insert Effect.** For more information, see “Swap Insert Effect” on page 159.

## Combination P9: Master/Total Effect

Here you can make settings for the master effects and total effects. For instance, you can:

- Route a sound to an master effects and total effects

- Make detailed settings for master effects and total effects

For more information, please see “Effect Guide” on page 857.

### 9-1: Routing

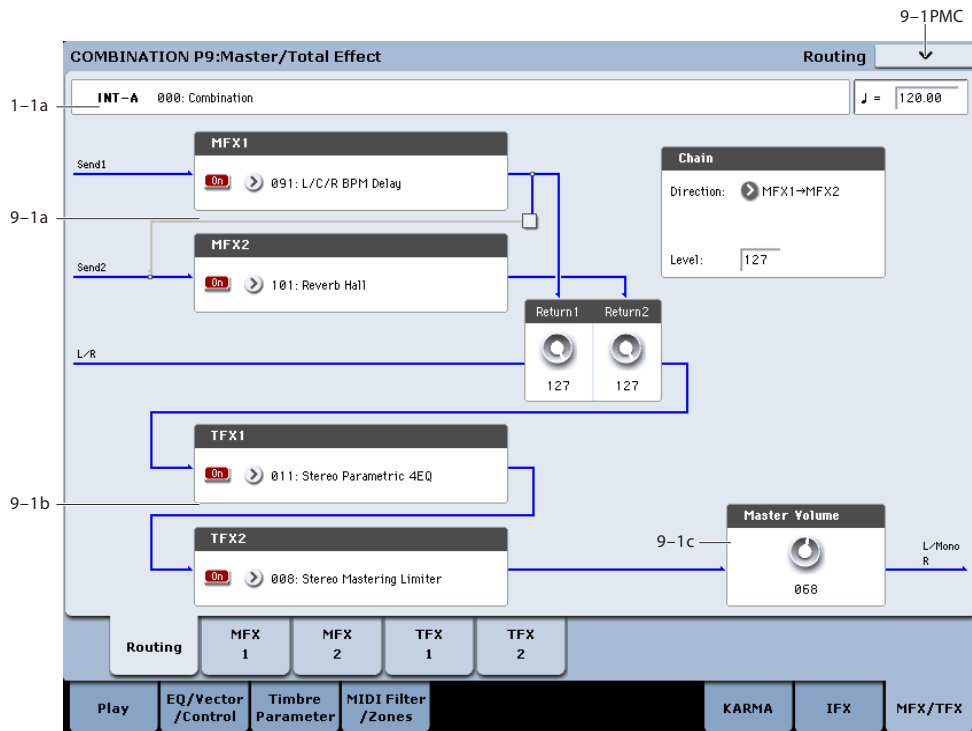

Here you can specify the type of master effects and total effects, and turn them on/off.

The master effects are sent to the L/R bus. The total effects are inserted into the L/R bus.

#### 9-1a: MFX1, 2

##### MFX1

MFX1 [000...185]

MFX1 On/Off [Off, On]

Return 1 [000...127]

##### MFX2

MFX2 [000...185]

MFX2 On/Off [Off, On]

Return 2 [000...127]

##### Chain

Chain On/Off [Off, On]

Chain Direction [MFX1->MFX2, MFX2->MFX1]

Chain Level [000...127]

These parameters are the same as in Program mode. For more information, please see “9-1a: MFX1, 2” on page 143.

#### 9-1b: TFX1, 2

##### TFX1

TFX1 [000...185]

TFX1 On/Off [Off, On]

##### TFX2

TFX2 [000...185]

TFX2 On/Off [Off, On]

These parameters are the same as in Program mode. For more information, please see “9-1b: TFX1, 2” on page 144.

9-1c: Master Volume

Master Volume [000...127]

▼ 9-1: Page Menu Commands

The number before each command shows its ENTER + number-key shortcut. For more information on these shortcuts, see “ENTER + 0-9: shortcuts for menu commands” on page 147.

- 0: **Write Combination.** For more information, see “Write Combination” on page 501.
- 1: **Exclusive Solo.** For more information, see “Exclusive Solo” on page 147.
- 2: **Copy MFX/TFX.** For more information, see “Copy MFX/TFX” on page 162.
- 3: **Swap MFX/TFX.** For more information, see “Swap MFX/TFX” on page 163.

9-2: MFX1

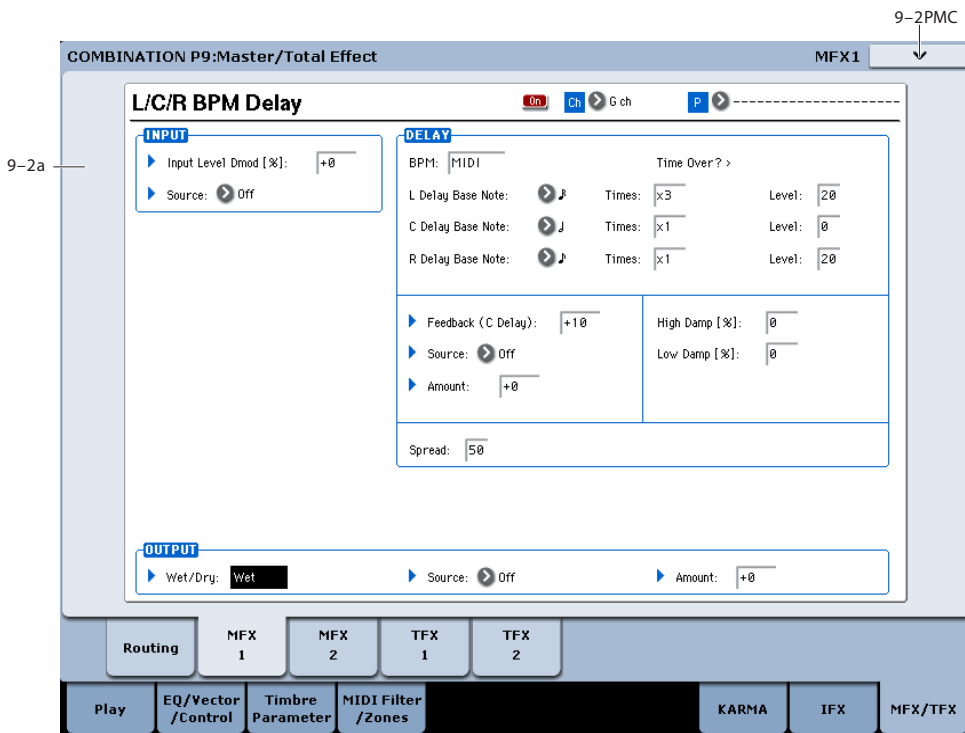

Here you can edit the parameters of the effect you selected for MFX1 in the P9- Routing page.

Effects Modulation: Dmod

Most effects have one or more parameters which can be modulated in realtime. In the KRONOS, this is called Dynamic Modulation, or Dmod for short.

For a complete list of Dmod sources, see “Dynamic Modulation Source List” on page 1101.

**MIDI** You can use different MIDI channels to control Dmod for each effect, if desired, as selected by the **Ch (Control Channel)** parameter.

9-2a: MFX1

MFX1 On/Off [Off, On]

This turns master effect 1 on/off. This is linked with the on/off setting in the P9-Routing page.

**Ch (Control Channel)** [Ch01...16, G ch]



Specifies the MIDI channel that will control dynamic modulation (Dmod) for the master effect.

**Ch01...Ch16:** The specified MIDI channel will be used for control.

**G ch:** The global **MIDI Channel** (Global 1-1a) will be used for control. Normally you will use the G ch setting.

**P (Effect Preset)** [P00, P01...15, U00...15, -----]

Effect Presets let you easily store and recall all of the settings for an individual effect. You can store up to 16 user presets for each effect type, in addition to 15 re-writable factory presets.

The same presets appear in all of the modes (Program, Combination, Sequence, and Sampling), and sets of presets can be saved to and loaded from disk.

Note that edits to effects parameters are automatically stored with the Combination—you don't need to store them as an Effect Preset. Presets just make it easier to re-use your favorite settings.

For instance, you can save an Effect Preset while working on a particular Combination, and then later use the same Effect Preset in a different Program, Combination, or Song.

**P00: Initial Set:** These are the default settings that are recalled when you select an effect type in the Insert FX page. You can't save your own settings here.

**P01...P15:** These contain Korg preset data. We recommend that you store your settings in U00–U15.

**U00...U15:** These are areas in which you can store your own settings.

-----: This shows that no Effect Preset has been selected. You'll see this if you've just selected an effect, written a Combination, or selected a new Combination. Selecting this setting from the menu will not have any effect.

**Note:** Combinations save the effects parameter settings, but they don't save the number of the selected Effect Preset. If you select an Effect Preset, and then save the Combination, the Effect Preset setting will revert to "-----."

For more details, see "Using Effect Presets" on page 141.

### MFX1 Parameters

Here you can set the effect parameters of the insert effect you chose in the P9–Routing page.

For details on the master effects, please see the "Effect Guide" on page 857.

---

## ▼ 9–2: Page Menu Commands

The number before each command shows its ENTER + number-key shortcut. For more information on these shortcuts, see "ENTER + 0-9: shortcuts for menu commands" on page 147.

- **0: Write Combination.** For more information, see "Write Combination" on page 501.
- **1: Exclusive Solo.** For more information, see "Exclusive Solo" on page 147.
- **2: Copy MFX/TFX.** For more information, see "Copy MFX/TFX" on page 162.
- **3: Swap MFX/TFX.** For more information, see "Swap MFX/TFX" on page 163.
- **4: Write FX Preset.** For more information, see "Write FX Preset" on page 163.

---

## 9–3: MFX2

---

## 9–4: TFX1

---

## 9–5: TFX2

These pages let you edit the parameters of Master Effect 2 and Total Effects 1 and 2. To select different effects types, use the P9–Routing page.

The parameters of MFX2, TFX1, and TFX2 are the same as for MFX1. For more information, please see "9–2: MFX1" on page 499.

## Combination: Page Menu Commands

### ENTER + 0–9: shortcuts for menu commands

Each page has a set of menu commands, which provide access to different utilities, commands, and options, depending on the page you're currently on. You can use the menu commands entirely from the touch-screen, by pressing the menu button in the upper right-hand corner of the screen and then selecting an option from the menu that appears.

Even though each page may have its own unique menu commands, the menus are standardized as much as possible. For instance, WRITE is almost always the first menu item in Program, Combination, and Sequence modes.

You can take advantage of this standardization by using a shortcut to access any of the first ten menu items:

1. Hold down the ENTER key.
2. Press a number (0–9) on the numeric keypad to select the desired menu command, starting with 0.

For instance, press 0 for the first menu command, 1 for the second, and so on.

If the menu command just toggles an option on and off (such as Exclusive Solo), then you're done. If the command calls up a dialog box, the dialog will appear on the LCD, and you can proceed just as if you'd selected the command from the touch-screen.

### Write Combination

This command writes an edited Combination into the KRONOS internal memory. It is available on every page in Combination mode.

This lets you:

- Save your edits
- Rename the Combination
- Assign the Combination to a Category
- Mark the Combination as a Favorite
- Copy the Combination to a different Bank and number

Be sure to **Write** any Combination that you wish to save. An edited Combination cannot be recovered if you do not write it before turning off the power or selecting another Combination.

 Do not turn off the power for at least 10 seconds after using the **Write Combination** command. This allows the system time to complete the process, which includes saving a backup of the data to the internal disk.

For more information, please see "Write Program" on page 147.

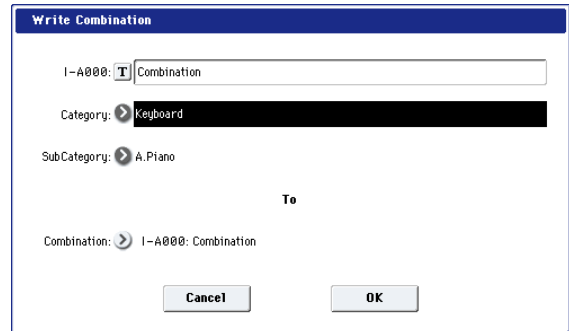

If you use "Category" or "Sub Category" to specify a category for the combination you are writing, you will be able to select that combination by its category or sub category in Combination P0: Play.

The names of the combination categories can be edited in "Combi Category" (Global 3–2).

*Note:* You can also use the SEQUENCER REC/WRITE switch to write a combination in the same way as "Write Combination." Press the SEQUENCER REC/WRITE switch to open the dialog box, and write the combination. In this case, the data will be written to the currently selected combination.

### Exclusive Solo

This command is available on every page in Combination mode. When **Exclusive Solo** is **On**, only one Timbre is soloed at a time; when it is **Off**, multiple Timbres can be soloed together.

For more information, please see "Exclusive Solo" on page 147.

### Copy From Program

This command is available on every page in Combination mode. It copies Effects and/or KARMA settings from a selected Program to the current Combination. This lets the Program sound the same as it did in Program mode.

1. Select "Copy From Program" to open the dialog box.

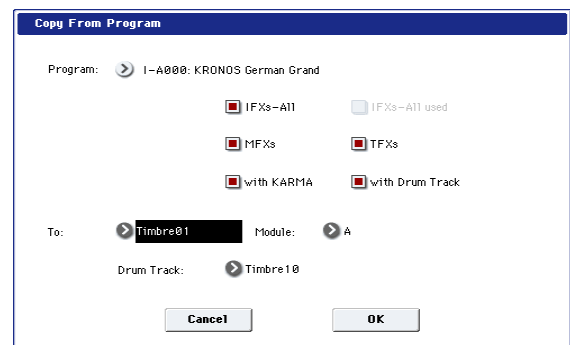

2. Use "Program" to select the copy-source program.
3. Select the IFX-All, IFX-All used, MFXs, and TFXs options to specify which, if any, of the Program's effects settings to copy.



**IFX-All:** The settings of all insert effect settings (the contents of the Insert FX page and the IFX1–12 effect parameters) of the copy-source program will be copied.

**IFX-All used:** Only the insert effects used by the copy-source program will be copied. The copied settings will be packed into vacant slots (i.e., slots with 000: No Effect, unless such slots are located inside the chain).

*Note:* Copy-source insert effects set to 000: No Effect will not be copied. However, if 000: No Effect is located inside the chain, it will be copied.

**MFxs:** All master effect settings of the copy-source program will be copied.

**TFxs:** All total effect settings of the copy-source program will be copied.

About the Bus Select (8–1b, 8–2a, 8–5a) setting

- Regardless of the **IFX-All**, **IFX-All used**, **MFxs**, and **TFxs** settings, will be set to DKit if the copy-source program’s “Use DKit Setting” is checked. In conjunction with this, the “Drum Kit IFX Patch” setting will be reset to the default setting.
- If **IFX-All** is checked, the **Bus Select** setting of the copy-source program will be copied. If the copy-destination timbre **Bus Select** was set to IFX1–IFX12, it will automatically be set to L/R. If you check **IFX-All used**, the routing will be automatically set to match the copy-source program.
- If **IFX-All** and **IFX-All used** is unchecked, then the copy-source **Bus Select** setting will be ignored. or if the **Bus Select** of the copy-source program and copy-destination timbre is set to IFX1–IFX12, it will automatically be set to L/R.

**4. If you check “with KARMA,” the Program’s KARMA settings will also be copied.**

If this is On (checked), the KARMA Module settings of the copy-source program will be copied to the KARMA Module you specify in step 6. The Pads settings will be also be copied.

In Combination mode, the KARMA Module’s “Input Channel” will be set to Gch, its “Output Channel” will be set to the MIDI channel of the timbre you specify in step 5, and “Track Thru” will be turned On (checked).

**5. Use the “To” field to specify the copy-destination timbre.**

The parameters for each timbre will be initialized. The copy-source program will be assigned to “Program” (“0–1b: Timbre Program Select” on page 418).

- The **MIDI Channel** (2–1a) setting will not change if “with KARMA” is checked. If “with KARMA” is unchecked, **MIDI Channel** will be automatically set to G ch.
- The “Bank Select (When Status=EX2)” (2–1a) setting will not change.
- The **Status** (2–1a) setting will automatically be set to INT.
- The P1–Set Up Controller settings of the copy-source program will be copied.

6. Use the “Module” field to select the copy-destination KARMA Module; either A, B, C, or D.
7. Press the OK button to execute the copy. If you decide not to execute, press the Cancel button.

### Optimize RAM

**Optimize RAM** is available on the Audio In/Sampling tab of the Play page. This command reorganizes unused space in RAM, allowing the full amount of remaining memory to be used.

For more information, please see “Optimize RAM” on page 148.

### Select Sample No.

**Select Sample No.** is available on the Audio In/Sampling tab of the Play page.

This specifies the sample number into which the sampled data will be written. You can also specify whether the sample will automatically be converted to a program after sampling. **Select Sample No.** can be selected if you have selected RAM as the “Save to” destination.

For more information, please see “Select Sample No.” on page 149.

### Select Directory/File for Sample to Disk

This command is available on the Audio In/Sampling tab of the Play page, when the sampling **Save To** parameter is set to DISK.

When sampling to disk, this lets you set the disk, directory, and file name for the resulting WAVE file.

For more information, please see “Select Directory” on page 149.

### Auto Sampling Setup

**Auto Sampling Setup** is available on the Audio In/Sampling tab of the Play page.

This command automatically sets sampling-related parameters in Combination mode. This is a helpful convenience when you’re resampling your performance on a combination, or when you’re using a combination as a guide while sampling an external source. You can also use this command to initialize the settings.

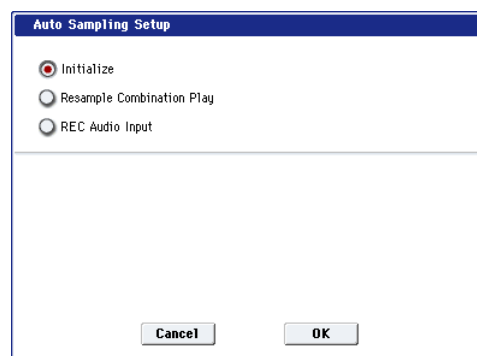

- **Initialize:** Sets sampling-related parameters to their default state.

**Resample Combination Play:** Makes settings so you can play a combination and resample your performance.

**REC Audio Input:** Makes settings so you can sample an external audio source while listening to yourself play a combination.

For more information, please see “Auto Sampling Setup” on page 150.

## Copy Tone Adjust

**Copy Tone Adjust** is available on the Control Surface page when **CONTROL ASSIGN** is set to **Tone Adjust**.

This command replaces the Tone Adjust settings of the selected Timbre (Combination mode) or Track (Sequencer mode) with those of any other Program, Timbre, or Track.

1. **Select the Timbre (Combination mode) or Track (Sequencer mode) whose Tone Adjust settings you want to replace.**

You can either use the parameter on the right side of the display (as shown below), or use this Control Surface shortcut:

- Press and hold the **TONE ADJ./EQ** button.
- While holding **TONE ADJ./EQ**, press one of the **PLAY/MUTE** buttons to select Timbres/Tracks 1-8, or one of the **SELECT** buttons to select Timbres/Tracks 9-16.

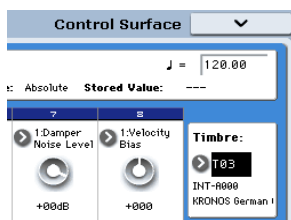

2. **Select “Copy Tone Adjust” to open the dialog box.**

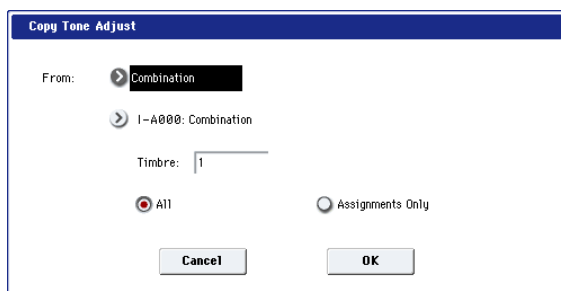

3. **Use From to select the Program, Combination, or Song from which to copy.**

You can also use the front-panel BANK keys to select the desired bank.

4. **If you’ve selected a Combination or Song, select a specific Timbre or Track as well.**
5. **Choose either All or Assignments Only to select the Tone Adjust parameters that you want to copy.**

**All:** This copies both the Tone Adjust parameter assignments and values.

**Assignments Only:** This copies only the Tone Adjust parameter assignments, without the values.

6. **To execute the Copy Tone Adjust command, press the OK button. To exit without copying the controls, press the Cancel button.**

## Reset Tone Adjust

**Reset Tone Adjust** is available on the Control Surface page when **CONTROL ASSIGN** is set to **Tone Adjust**.

This command affects only the selected Timbre or Track, as opposed to the entire Combination or Song. It resets the Tone Adjust settings for all of the Track/Timbre’s Knobs, Switches, and Sliders to their default values.

1. **Select the Timbre (Combination mode) or Track (Sequencer mode) to reset.**

You can either use the parameter on the right side of the display (as shown below), or use this Control Surface shortcut:

- Press and hold the **TONE ADJ./EQ** button
- While holding **TONE ADJ./EQ**, press one of the **PLAY/MUTE** buttons to select Timbres/Tracks 1-8, or one of the **SELECT** buttons to select Timbres/Tracks 9-16.

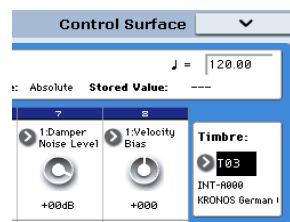

2. **Select “Reset Tone Adjust” to open the dialog box.**

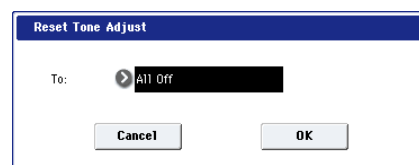

3. **Use the “To” field to specify how the Tone Adjust parameters will be reset.**

**All Off:** All parameters will be reset to Off.

**Default Setting:** The parameters will be reset to the default settings for the corresponding program type (HD-1, AL-1, CX-3).

4. **To execute the Reset Tone Adjust command, press the OK button. To exit without resetting the controls, press the Cancel button.**

## Show EQ Graphic

**Show EQ Graphic** is available on the Timbre EQ tab of the EQ/Vector/Controller page.

This command calls up a floating window, showing a graphic representation of the selected Timbre’s EQ settings. You can leave the window open as you work; as you change EQ settings, or select different Timbres, the graphic will update accordingly.

The window will cover the parameters for some of the Timbres on either the right or left sides of the display. If you select one of these Timbres, the window will automatically move to the other side of the display.

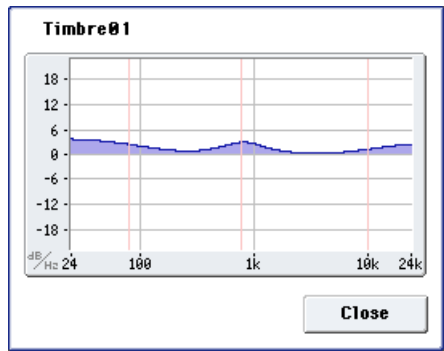

### Copy Vector Envelope

**Copy Vector Envelope** is available on the Vector Envelope tab of the EQ/Vector/Controller page.

This command copies the vector envelope from a specified program, combination/timbre, or song. For more information, see “Copy Vector Envelope” on page 153.

### Copy Pad Setup

**Copy Pad Setup** is available on the Pads tab of the EQ/Vector/Controller page.

This command copies the Pad from a specified program, combination/timbre, or song. (“Use the “From” field to select the mode, bank, and number of the desired copy-source. You can press a BANK key to select the desired bank.” on page 154)

### Detune BPM Adjust

**Detune BPM Adjust** is available on the Pitch tab of the Timbre Parameters page.

This command changes a loop’s tempo by changing the Timbre’s **Detune** parameter. The sample data itself is not altered. Since this alters the pitch of the loop along with the tempo, it’s generally suited only to un-pitched percussive loops.

**Note:** Using **Detune BPM Adjust** will over-write any previous **Detune** settings.

1. Go to the Pitch tab of the Timbre Parameters page.
2. Select the Detune parameter for the desired Timbre.

**Detune BPM Adjust** is available only when the **Detune** parameter has been selected. Otherwise, the menu selection will be grayed out.

3. Select “Detune BPM Adjust” to open the dialog box.

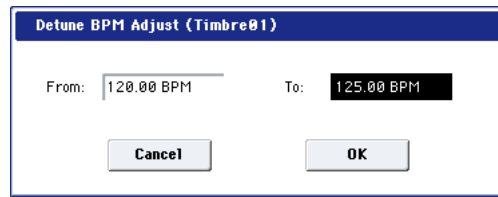

4. In **From**, specify the loop’s original BPM value. Ignore any previous changes from using **Detune BPM adjust**.
5. In **To**, specify the desired BPM value. The appropriate **Detune** value will be calculated automatically from these two values. For example, if you set “From” to 60 bpm and “To” to 120 bpm, **Detune** will be set to +1200 (one octave up).
6. To execute the **Detune BPM Adjust** command, press the **OK** button. To exit without changing the **Detune** value, press the **Cancel** button.

**Note:** since this command does not affect the sample data itself, and always over-writes the previous **Detune** amount, using it repeatedly has no cumulative effect.

### Copy KARMA Module

This command copies the settings of the KARMA Module used by a specified program, combination, or song.

1. Select “Copy KARMA Module” to open the dialog box.

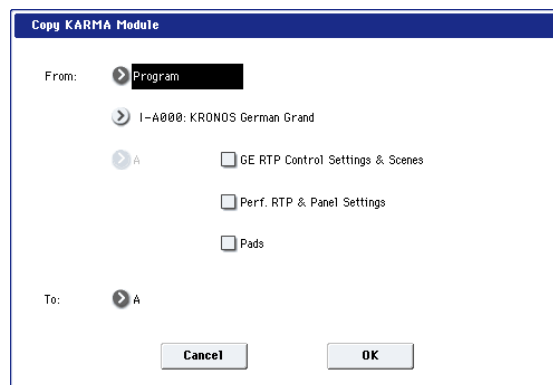

2. In “From,” select the copy source mode, bank, and number. You can press a BANK SELECT A–G switch to select the bank.
3. If you selected a combination or song as the copy-source, select the module from which you want to copy.
4. As appropriate for the content that you want to copy, turn “GE RTP Control Setting & Scenes” On (checked).

For more information, see “Settings copied by Copy KARMA Module,” below.

5. To copy performance realtime parameters, Dynamic MIDI, and front panel settings, turn “Perf. RTP & Panel Settings” On (checked). (see “Settings copied by Copy KARMA Module,” below)

6. To copy the note and velocity settings of pads 1–8, turn “Pads” On (checked).
7. Use the “To” field to select the copy-destination KARMA module.
8. Press the OK button to execute the Copy KARMA Module command, or press the Cancel button if you decide to cancel.

### Settings copied by Copy KARMA Module

#### Copying from a Program

If GE RTP Control Setting & Scenes and Perf. RTP & Panel Settings are both Off (checked) when copying from a Program, the following content is copied:

- The selected GE, including the GE realtime parameters.
- Settings of the KARMA module parameters (from pages 7–3: Module Parameter-Trigger and 7–4: Module Parameter-Control).
- 7–5: GE RTP page MIN, MAX, and VALUE settings.

If GE RTP Control Setting & Scenes is turned On (checked), the following will also be copied:

- 7–5: GE RTP page ASSIGN and Polarity settings.
- The scene selected in the master buffer (A).
- The KARMA SLIDER and SWITCH settings for each scene (0–6d: Realtime Controls and 0–9f: R.Time Knobs/KARMA settings).
- 7–8: Name/Note Map controller name settings.

If Perf. RTP & Panel Settings is turned On (checked), the following will also be copied:

- Tempo setting.
- Time Signature setting.
- KARMA ON/OFF switch setting.
- KARMA LATCH switch setting.
- 7–6: Perf Real– Time Parameters page settings.
- 7–7: Dynamic MIDI page settings.

#### Copying from a Combination or Song

If GE RTP Control Setting & Scenes and Perf. RTP & Panel Settings are both Off (checked) when copying from a Combination or Song, the following content is copied:

- The selected GE, including the GE realtime parameters.
- KARMA module parameters (from pages 7–3: Module Parameter-Trigger and 7–4: Module Parameter-Control).
- 7–5: GE RTP page MIN, MAX, and VALUE settings.

If GE RTP Control Setting & Scenes is turned On (checked), the following will also be copied:

- 7–5: GE RTP page “ASSIGN” and Polarity settings.
- The KARMA CONTROLS slider and KARMA SWITCH settings of each scene in the copy-source buffer, and the currently selected scene.
- 7–8: Names/Note Map controller name settings.

If Perf. RTP & Panel Settings is turned On (checked), the following will also be copied:

- Tempo setting.
- Time Signature setting.
- KARMA ON/OFF switch setting.
- KARMA LATCH switch setting.
- KARMA Module Control switch setting.
- 7–6: Perf Real– Time Parameters page settings.
- 7–7: Dynamic MIDI Page settings.

⚠ The “Input Channel” and “Output Channel” (Combination/Sequencer P7–1) settings of a combination or song are not copied.

---

## Initialize KARMA Module

This command initializes the settings of the KARMA Module.

⚠ The GE selection will not be initialized. The GE parameters will be set to the selected GE’s default values.

1. Select “Initialize KARMA Module” to open the dialog box.

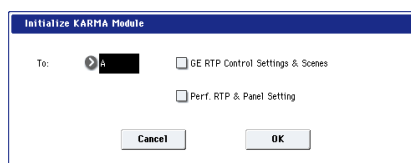

2. In “To,” select the KARMA Module that you wish to initialize.
3. According to the content you want to initialize, you can turn “GE RTP Control Settings & Scenes” and/or “Perf. RTP” ON (checked).

For more information, see “Settings initialized by Initialize KARMA Module” on page 156.

⚠ The KARMA SLIDER and SWITCH settings and names in each master buffer are initialized as when the Pref. RT & Panel Setting option is On (checked).

4. To initialize the settings, press the OK button. To cancel without initializing, press the Cancel button.

---

## Copy Scene

Please see “Copy Scene” on page 157.

---

## Swap Scene

Please see “Swap Scene” on page 157.

---

## Capture Random Seed

Please see “Capture Random Seed” on page 157.

## Auto Assign KARMA RTC Name

This command is available on the KARMA GE tab of the Play page, and the Name/Note Map tab of the KARMA page.

For more information, please see “Auto Assign KARMA RTC Name” on page 148.

## Copy Note Map

Please see “Copy Note Map” on page 148.

## Copy Insert Effect

This command copies effects settings from Program, Combination, Song, or Sampling modes. For more information, please see “Copy Insert Effect” on page 159.

**Note:** the slot’s MIDI control channel, as specified by the **Ch** parameter on the IFX1–12 pages, will not be copied.

## Swap Insert Effect

This command swaps (exchanges) insert effect settings. For more information, please see “Swap Insert Effect” on page 159.

**Note:** the slot’s MIDI control channel, as specified by the **Ch** parameter on the IFX1–12 pages, will not be swapped.

## Insert IFX Slot

For more information, please see “Insert IFX Slot” on page 160.

## Cut IFX Slot

For more information, please see “Cut IFX Slot” on page 161.

## Clean Up IFX Routings

For more information, please see “Clean Up IFX Routings” on page 162.

## Drum Kit IFX Patch

This patches the **Bus Select** settings for each key of a drum kit, temporarily changing the insert effect connection destinations. You can execute this only if the timbre’s program is a drum program, “DKit” is checked, and the **Bus Select** (Global 5–3b) setting of the keys in the drum kit is set to either IFX1–12.

1. In the **Routing1** page or **Routing2** page, select the timbre for which you want to make settings. (Select a timbre parameter or Timbre Number.)



2. Select Drum Kit IFX Patch to open the dialog box.

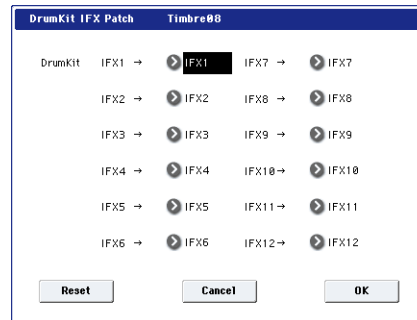

3. In the DrumKit “IFX” popup, select the output bus to which you want to patch the signal: an insert effect or L/R, 1–4, 1/2–3/4, or Off.

4. To execute the Drum Kit Insert Effect Patch command, press the OK button. To cancel, press the Cancel button.

*Note:* To restore the condition of the drum kit, execute IFX1→IFX1, IFX2→IFX2, IFX3→IFX3, IFX4→IFX4, IFX5→IFX5, IFX6→IFX6, IFX7→IFX7, IFX8→IFX8, IFX9→IFX9, IFX10→IFX10, IFX11→IFX11, and IFX12→IFX12.

Alternatively, you can press the **Reset** button to restore the same settings.

## Copy MFX/TFX

This command copies effect settings from Program, Combination, Song, or Sampling modes. For more information, please see “Copy MFX/TFX” on page 162.

**Note:** the slot’s MIDI control channel, as specified by the **Ch** parameter on the MFX 1-2 and TFX 1-2 pages, will not be copied.

## Swap MFX/TFX

This command swaps (exchanges) insert effect settings. For more information, please see “Swap MFX/TFX” on page 163.

**Note:** the slot’s MIDI control channel, as specified by the **Ch** parameter on the MFX 1-2 and TFX 1-2 pages, will not be copied.

## Write FX Preset

For more information, please see “Write FX Preset” on page 163.

## Copy Drum Track

This command copies the Drum Track pattern and other settings from another Program, Combination, or Song. Note that the Drum Program used by the Drum Track is *not* copied; you’ll need to set up a Timbre to receive on the Drum Track’s MIDI Channel, and select an appropriate Drum Program for that Timbre.

---

## Erase Drum Track Pattern

This erases the specified drum track pattern. For more information, see “Erase Drum Track Pattern” on page 635.





# Sequencer mode

## Sequencer Overview

The KRONOS contains a sophisticated sequencer that integrates a 16-track MIDI sequencer with a 16-track hard disk recorder.

The sixteen MIDI tracks and the master track (which contains tempo data, etc.) allow you to record and play back MIDI data for the internal tone generator or for external sound modules, and the sixteen audio tracks allow you to record and play back audio signals on the internal hard disk recorder in synchronization with the MIDI tracks. You can use the audio tracks to record external audio sources such as guitar or vocals as well as the sound produced by the internal tone generator. You can also automate parameters such as volume and pan.

When you've completed a song, you can resample it as a WAVE file and use Disk mode to burn it as an audio CD. This entire process can be completed on the KRONOS itself.

The In-Track Sampling function, Time Stretch/Slice function, KARMA function, the sophisticated effects, controllers, and the numerous other functions of the KRONOS can be used together to give you a wide range of possibilities for music production or live performance.

---

## Template Songs

Template Songs store pretty much everything in the Song except for the MIDI and audio data itself. This includes Program selections, track parameters, effects and KARMA settings, and the Song's name and tempo.

The factory preset Template Songs let you get up and running quickly with matched sets of sounds and effects for various styles of music. You can also create your own Template Songs with your favorite sounds and setups.

---

## MIDI sequencer

- The sequencer lets you record a maximum of 400,000 MIDI events (or 300,000 audio events), up to 200 songs, and as many as 999 measures per song.
- Timing resolution is a maximum of  $\downarrow/480$ .
- There are sixteen tracks for MIDI performance data, and a master track that controls the time signature and tempo.
- KARMA can be used during playback or recording.
- The RPPR (Realtime Pattern Play/Recording) function can be used during playback or recording.
- Eighteen different Template Songs are built-in, and contain program and effect settings suitable for various musical styles. You can create up to sixteen original templates, and save them as user Template Songs.

Note that Template Songs do not include the MIDI data for song tracks and patterns, audio data, or settings that govern how the musical data is played back, including **Meter**, **Metronome**, **PLAY/MUTE**, and **Track Play Loop** (including Start/End measure).

While loading a Template Song, you can also optionally load one or more Drum Track patterns.

For more information, please see "Template Songs" on page 77 of the Operation Guide.

---

## Important notes about Sequencer mode

Immediately after the power is turned on, KRONOS will not contain any song data, so if you wish to playback a song on the sequencer, you must first load data from media or receive a MIDI data dump from a MIDI filer.

- ⚠ When you turn off the power, the settings made in Sequencer mode and the song data that you recorded will not be backed up. If you wish to keep this data, you must save it on media (internal hard disk, external USB drive etc.) before turning off the power, or perform a MIDI data dump to save the data on an external data filer etc.
- ⚠ When you create audio tracks, we recommend that you save them on the internal hard disk, since audio tracks can be recorded and played back only on the internal hard disk.
- ⚠ To record audio tracks, **MIDI Clock** must be set to **Internal**. For more information, see "MIDI Clock (MIDI Clock Source)" on page 772.

- A track play loop function lets you loop specified measures independently for each track.
- A large number of preset patterns ideal for drum tracks are built in. In addition, you can create up to 100 user patterns for each song. These patterns can be used as musical data within a song, or can be played by the RPPR function.

---

## MIDI recording features

- Various methods of recording are supported, including realtime recording in which your performance on the keyboard and controllers (including MIDI control events) is recorded just as you play, and step recording in which the timing, length, and velocity of each note can be specified in the LCD as you input the pitches from the keyboard.

- The musical data and control events that you recorded can be edited in various ways (including event editing and many other edit commands).
- MIDI System Exclusive (SysEx) messages can be recorded and played back. SysEx messages received from an external MIDI device or parameter changes produced by editing track parameters or effect parameters can be recorded in real-time on any desired track.

---

### Parameter-related features

- When the **Status** of a track is set to INT or BTH, an external sequencer can be used to play KRONOS as a multi-timbral tone generator. When the **Status** of a track is set to BTH, EXT, or EX2, the sequencer of KRONOS can play external tone generators.
- Tone Adjust parameters let you make temporary adjustments to the sound of the program used by a track, while leaving the original program unchanged. While creating a song, you can use this capability to make changes in realtime by (for example) softening the tone of the bass sound or sharpening the attack of the strings without having to return to Program mode and edit the program itself.
- KRONOS's AMS (Alternate Modulation) capability lets you use control changes for realtime control of the parameters of the programs used in a program. Its MIDI Sync abilities let you synchronize the LFO speed to changes in the tempo.
- Dmod (Dynamic Modulation) functionality lets you control effect parameters in realtime. You can also use MIDI Sync to synchronize the LFO speed or delay time to changes in the tempo.

---

### Editing and operation features

- The function lets you instantly set up program or combination settings of Program mode or Combination mode as a song, so that you can start recording simply by pressing the SEQUENCER START/STOP switch.  
This lets you seamlessly move from playing a program or combination to producing a song. When you come up with a phrase or an idea, this function lets you easily turn your inspiration into a song.
- Program and Combination settings can be copied to a song.
- Sequencer data such as a song that you create can be saved in KRONOS's native format, or transmitted as a MIDI data dump.
- A song you created can be converted into SMF (Standard MIDI File) data. SMF songs can also be loaded.
- The **Play/Rec/Mute** and **Solo** buttons let you instantly play/mute any desired track on the fly.
- You can rewind or fast-forward MIDI Tracks while listening to the sound.

---

### Sampling features

- Multisamples you create can be played back together with internal programs in Sequencer mode. The Time Slice function of Sampling mode lets you divide a rhythm loop sample and create performance data that corresponds to the divided samples. In Sequencer mode you can play this performance data, and adjust the playback tempo without affecting the pitch of the rhythm loop sample. You can also exchange the note numbers of the data, or modify the timing to freely re-create new rhythm loops.
- The KRONOS provides an In-Track Sampling function which lets you sample an external audio source while the song plays back, and will automatically create note data to trigger that sample at the appropriate point during the playback of the track.

---

### Hard disk recorder section

- You can use up to 300,000 audio events (or 400,000 MIDI events), up to 200 songs, and up to 999 measures per song.
- Sixteen audio tracks are provided. Each track provides linear 16-bit PCM recording, with a maximum length of 80 minutes for one recorded take.
- Automation data (volume, pan, EQ, send 1/2) can be recorded for each track.
- Sixteen tracks can be played back simultaneously, and four tracks can be recorded simultaneously.
- The Stereo Pair function lets you control two adjacent tracks by adjusting just the odd-numbered track. This lets you simultaneously make mixer settings for a pair of stereo-recorded tracks.
- A broad range of internal buses can be selected as the recording source: Audio Inputs 1–4, S/P DIF, USB, L/R, REC Bus 1–4, or Individual 1–4. Flexible routing even lets you insert effects into external audio sources and record them.
- When you realtime-record, an audio event and region data are created. The region data is linked with the WAVE data (audio data) recorded on the hard disk. You are free to edit this data in a variety of ways, such as moving the location of the audio event, or editing/replacing the region data or WAVE file.
- You can use numerous editing commands (including event editing) to edit the recorded audio events. Event editing lets you edit the time stamp or region data of the audio events.
- Region editing lets you edit the WAVE file selection, and adjust the start/end addresses of the WAVE file in units of a single sample.
- You can freely select a region of a WAVE file (mono, 48 kHz sample rate) and use it in your song. You can use commercially available sample data etc. in your song by sample-rate converting it from 44.1 kHz into 48 kHz. WAVE files editing

operations such as Volume Ramp and Normalize are also provided.

- The Time Stretch function lets you stretch or shrink the tempo of a phrase you recorded or a sample you assigned, making it match the tempo of your song.
- The convenient Anchor function makes it easy to place a phrase at the correct timing in your song.
- Auto and manual punch-in/out are provided.
- The Rehearsal function lets you practice punch-in/punch-out recording without actually recording anything.

- For each song, three-band EQ is provided on each MIDI track and each audio track.
- For each song, you can use twelve stereo insert effects, two stereo master effects, and two stereo total effects.
- When you've created songs, you can resample them to hard disk to create WAVE files, and then use Disk mode to create an audio CD from these WAVE files.
- In addition to the song name, you can assign names to each pattern, track, and region.
- You can use the LOCATE switch to move immediately to the desired location.

---

### Common section

- As the MIDI clock master, you can choose either Internal, External or Auto, letting you synchronize the KRONOS with other MIDI equipment.

---

## Setup parameters & Musical data

Each song consists of MIDI tracks 1–16, a master track, audio tracks 1–16, various song parameters such as the song name, settings for the vector function, settings for KARMA, effect settings, RPPR parameters, and 100 user patterns.

Up to 200 such songs can be created in the KRONOS.

MIDI tracks 1–16 and audio tracks 1–16 each consist of “track parameters” that specify the starting state of the track, and “playback data.” The master track consists of tempo and time signature data.

---

### MIDI tracks 1–16

#### Setup parameters

Bank/Program No.\*, Play/Rec/Mute, Pan\*, Volume\*

Track Play Loop, Loop Start Measure, Loop End Measure, Play Intro, EQ (Bypass, Low Gain, Mid Frequency, Mid Gain, High Gain) Status, MIDI Channel, Bank Select (When Status=EX2), Track Priority, Force OSC Mode, OSC Select, Portamento\*, Transpose\*\*, Detune\*\*, Bend Range\*\*, Use Program's Scale, Delay (Mode, Time, Base Note, Times), Wave Sequence (Key Sync, Swing, Quantize Trigger), KARMA Track On/Off Control, MIDI Filter, Key Zone, Velocity Zone, Track Name, IFX/Indiv.Out Bus, FX Control Bus, Rec Bus, Send1(MFX1)\*, Send2(MFX2)\*, DKit, Drum Kit IFX Patch

\* and \*\*: see “Automating MIDI setup parameters,” below.

#### Musical data

Note On/Off  
 Program Change (including Bank Select)  
 Pitch Bend  
 After Touch (and Poly Aftertouch)  
 Control Change  
 Pattern No.  
 Exclusive Messages (SysEx)

### Automating MIDI setup parameters

Most of the setup parameters can be automated simply by changing them while recording into a MIDI track in real-time. Changing the parameter sends a MIDI message, and when that MIDI message is played back, the parameter changes accordingly.

Setup parameters marked with a single asterisk \* transmit and receive specific MIDI messages, such as CCs.

Setup parameters marked with two asterisks \*\* respond to MIDI RPN messages, and also send and receive MIDI System Exclusive messages.

The other setup parameters transmit and respond to MIDI System Exclusive messages.

- For details on Control Change messages and RPN, see “KRONOS and MIDI CCs” on page 1120, and “Using RPN (Registered Parameter Numbers)” on page 1136.
- For details on MIDI System Exclusive messages, see “System Exclusive events supported in Sequencer mode” on page 661.

---

### Master track

#### Setup parameters/Musical data

Time signature, Tempo

Both Time signature and Tempo can be automated, simply by changing them in real-time during recording. Any changes are recorded into the Master Track.

---

### Audio tracks

#### Setup parameters

Rec Source, Play/Rec/Mute\*\*\*, Pan\*\*\*, Volume\*\*\*  
 EQ (Bypass\*\*\*, Low Gain\*\*\*, Mid Frequency\*\*\*, Mid Gain\*\*\*, High Gain\*\*\*), Delay (Mode, Time, Base Note, Times), Track Name, IFX/Indiv.Out Bus, FX Control Bus, Rec Bus, Send1(MFX1)\*\*\*, Send2(MFX2)\*\*\*

### Musical data

Audio events  
Automation events

### Automating Audio setup parameters

All of the Audio setup parameters can be automated simply by changing them while recording in real-time. Some use audio automation data, while others use MIDI System Exclusive messages.

Setup parameters marked with three asterisks \*\*\* generate and respond to audio automation data. You can record changes to these parameters into audio tracks, in real-time.

The other setup parameters transmit and respond to MIDI System Exclusive messages. You can adjust these parameters during realtime recording, and record the resulting MIDI System Exclusive messages into a MIDI track.

### WAVE files, regions, and audio events

The data recorded on an audio track consists of a WAVE file, a “region” containing information specifying the section of the WAVE file that will actually be played, and an “audio event” containing data that specifies the locations in the song at which that region will start and stop.

You should be aware that audio events and regions can be deleted by event editing or region editing commands, and can also be lost by turning off the power before saving them to the internal disk. If only the WAVE file is left, leaving the WAVE file on the internal disk will unnecessarily occupy space, so we recommend that you execute the Disk Utility page menu command “Delete Unused WAV Files” to delete such files. For more information, see “Delete Unused WAV Files” on page 852.

If you power-off without deleting these WAVE files, a dialog box with the following message will appear the next time you power-on, asking you whether you want to delete these WAVE files or keep them:

There are un-saved audio files from your previous recording session.

Do you want to restore these files, or delete them from the disk?

[Restore] [Delete]

If you want to delete the files, press the Delete button. If you intend to use them in the future, for example in a new song, press the Restore button to keep them. We recommend that you delete unused WAVE files so that space on the internal hard disk is not occupied unnecessarily.

---

## Tip:

The function copies the settings of a program or combination to a song, and puts you in record-ready mode. Then you can simply press the SEQUENCER START/STOP switch to begin recording immediately. This lets you seamlessly move from playing a program or combination to producing a song. For example if you’ve been using KARMA and have come up with a phrase or an idea, this function lets you easily turn your inspiration into a song.

Procedure (example: Combination mode)

1. **Enter Combination mode.**
2. **In P0– Prog Select/Mixer page, select the desired combination and edit the KARMA RTC etc. as desired.**

*Note:* If you want to save the edited state of the combination, use the “Update Combination” or “Write Combination” menu commands.
3. **Hold down the ENTER switch and press the REC/WRITE switch.**

The “Setup to Record” dialog box will appear.
4. **To execute the function, press the OK button. If you decide not to execute, press the Cancel button.**

You will automatically move to Sequencer mode, and the settings of the combination will be copied to the song.

The first unused song will be the copy-destination song.

### Contents automatically copied from a combination

The copied contents will be the same as when you execute the page menu command **Copy From Combination** with the following settings in the dialog box.

- IFXs-All, MFXs, TFXs checked
- Multi REC Standby checked

### Contents automatically copied from a program

The copied contents will be the same as when you execute the page menu command **Copy From Program** with the following settings in the dialog box.

- IFXs-All, MFXs, TFXs checked
  - with KARMA checked
  - To set to MIDI Track 01
  - KARMA Module set to A
5. **The KRONOS will automatically enter record-ready mode, and the metronome will sound according to the Metronome setting (Sequencer 0–5d).**
  6. **Press the START/STOP switch to begin realtime recording. To stop recording, press the START/STOP switch once again.**

# Sequencer P0: Play/REC

## 0-1: MIDI Track Prog Select/Mixer

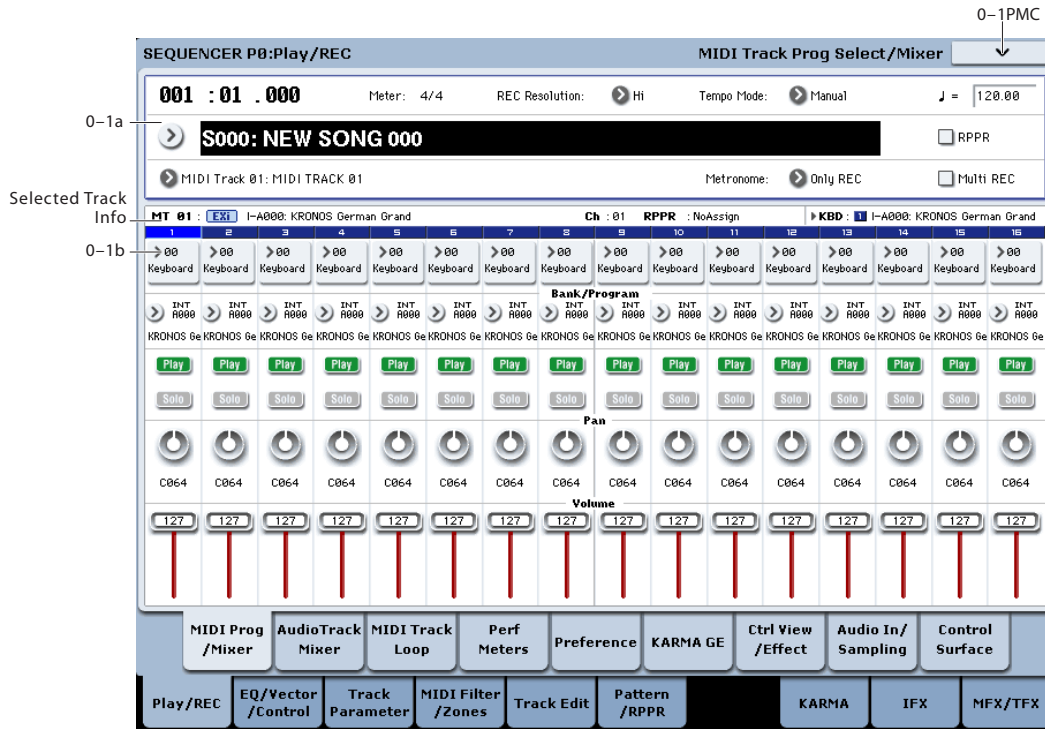

Here you can make basic settings for MIDI track recording and playing back in the song, and can select the program that will be used by each track.

### 0-1a: Location, Song/Track Select

**Location** [001:01.000...999:16.191]

This display shows the current position in the song. From the left, the numbers are the measure (001-999), beat (01-16), and clock (000-191). When you modify these values, the current location will change.

**MIDI** When **MIDI Clock** (Global 1-1a) is set to **Internal** (or **Auto**, if no MIDI clocks are being received), the KRONOS will transmit Song Position Pointer messages when the **Location** is changed.

Also, if the **MIDI Clock** parameter is set to **External MIDI** (or **Auto**, if MIDI clocks are currently being received), and **Receive Ext. Realtime Commands** (Global 1-1a) is on, the **Location** will change in response to received Song Position Pointer messages.

**The range in which the beat and clock can be modified will depend on the currently specified time signature.**

**Meter** [\*\*/\*\*, 1/4...16/4, 1/8...16/8, 1/16...16/16]

This is the time signature at the current location of the song. The time signature can be changed at each measure.

**\*\*/\*\***: This will be displayed when you press the SEQUENCER REC/WRITE switch. Specify this when you wish to use the time signature that is already recorded for that measure, and wish to record without changing the time signature.

**1/4-16/4, 1/8-16/8, 1/16-16/16**: This is the time signature at the current location of the song.

Set **Track Select** to a MIDI Track 01-16, or Audio Track 01-16 press the SEQUENCER REC/WRITE switch, and specify the time signature here.

When you press the SEQUENCER START/STOP switch to begin recording, the time signature you specify will be recorded on the Master Track and on the already-recorded tracks.

Be aware that if you press the SEQUENCER START/STOP switch during the pre-count to stop recording, the time signature will not be recorded.

Normally, you will specify the time signature when you record the first track, and select **\*\*/\*\*** when recording subsequent tracks.

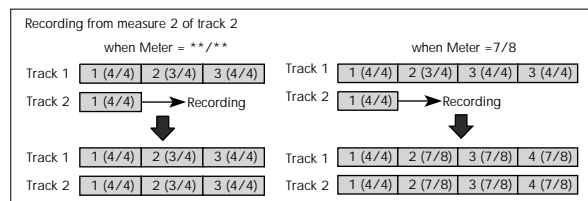

### Changing the time signature in the middle of a song

If you know beforehand the location at which you wish to change time signatures in the middle of a song, use the "Insert Measure" menu command to specify and insert the time signature for each measure of the same time signature, and then record your musical data.

If you wish to change the time signature in the middle of a song which already contains musical data, use **Track Select** to specify the Master Track (or any Track01–16 which contains data), and use the "MIDI Event Edit" menu command to modify the time signature of the Bar event. You can also change this by specifying an audio track and using the "Automation Edit" menu command.

If the number of beats in a measure increases when you modify the time signature, rests will be inserted in the portion that was added. Conversely if the number of beats decreases, that portion will not be played. However if you return to the original time signature, the data that had been hidden will once again be played. (The data itself will not be erased.)

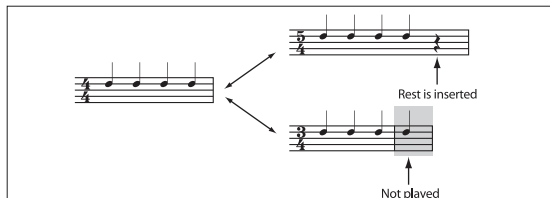

### REC Resolution (Realtime REC Quantize Resolution)

[Hi,  $\frac{1}{3}$ ,  $\frac{1}{4}$ ,  $\frac{1}{2}$ ,  $\frac{1}{3}$ ,  $\frac{1}{4}$ ,  $\frac{1}{2}$ ,  $\frac{1}{3}$ ,  $\frac{1}{4}$ ,  $\frac{1}{2}$ ]

This lets you correct timing as you record. It applies to all MIDI data, including notes and continuous controllers, as well as audio track automation.

Note that this does not affect previously-recorded data, or audio event data.

**Important:** The **REC Resolution** affects *all* MIDI and audio automation data. This can cause "stair-steps" in recorded controller data, such as pitch bend.

If you don't want this effect, set **REC Resolution** to **Hi** when recording, and then use the **Quantize** menu command afterward to correct only the desired type of data (such as notes).

**Hi (High Resolution):** Timing will not be corrected, and data will be recorded at the maximum resolution ( $\frac{1}{192}$ ).

$\frac{1}{3}$  -  $\frac{1}{4}$ : Timing will be corrected to the nearest interval of the specified rhythmic value. For example, if you select  $\frac{1}{3}$ , data will be corrected to the nearest 32nd-note triplet interval. If you select  $\frac{1}{4}$ , data will be corrected to the nearest quarter note interval.

**Audio events** are always recorded at the maximum, uncorrected resolution.

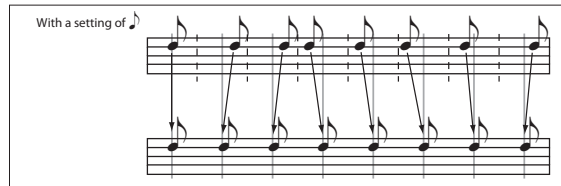

### Tempo Mode

[Auto, Manual, REC]

**Auto:** The tempo will follow the tempo of the Master Track. The tempo of the master track can be specified by using the **MIDI Event Edit** menu command, with the Master Track chosen in **Track Select**, or by the REC operation described below. When Auto is selected, it will not be possible to modify the "♩ (Tempo)" setting while a song is playing or recording (or during standby).

**Manual:** The "♩ (Tempo)" setting will be used.

**REC:** Tempo changes will be recorded on the Master Track.

### ♩ (Tempo)

[040.00...300.00, EXT]

This specifies the tempo of the song. This tempo applies to song playback and KARMA, etc.

**040.00...300.00:** When the "Tempo Mode" is Manual, this tempo will be used for recording and playback. When "Tempo Mode" is REC, this tempo will be recorded on the master track.

**EXT:** This will appear when **MIDI Clock** (Global 1–1a) is set to either External MIDI or Auto. The tempo of the internal sequencer will synchronize with MIDI Clock messages received from an external sequencer or other MIDI device, between 40 and 240 BPM.

If **MIDI Clock** (Global 1–1a) is set to "Internal," the above tempo setting (040.00–240.00) is used. If you've selected Auto, operation will automatically switch from Internal to External if MIDI Clock data is received from an external MIDI device connected to the MIDI IN connector, and this indication will appear.

*Note:* You can also adjust this by turning the TEMPO knob. Alternatively, you can set the tempo by pressing the TAP TEMPO switch at the desired interval.

*Note:* If Tempo is selected as an alternate modulation source, ♩ = 120.00 will be the base value.

### To record tempo changes

First, set **Track Select** to a MIDI Track.

Press the SEQUENCER REC/WRITE switch to enter recording-standby mode, you will be able to select REC.

Set **Tempo Mode** to **REC**, start recording, and change the system tempo either by turning the TEMPO knob, or using numeric keys 0–9 to enter a value and then pressing the ENTER switch. You can also vary the tempo by pressing the TAP TEMPO switch at the desired timing.

This cannot be selected when the Preferences page item **Recording Setup** is set to Loop All Tracks.

When you change the "♩ (Tempo)" value while recording, the tempo changes will be recorded, causing the tempo to change as the song progresses.



 You can't record tempo changes during audio recording.

Tempo changes can also be created using the "MIDI Event Edit" or "Create Control Data" menu commands.

*Note:* If you wish to record only the tempo changes, set **Recording Setup** (0-5a) to Overdub, and the tempo will be recorded on the master track without being affected by the musical data of **Track Select**.

**Song Select [000...199]**

Select the song that you want to record or play back.

Either select the song name from the popup menu, or use numeric keys 0-9 to specify the song number and then press the ENTER switch.

**Selecting a new song**

Choose a Song from the popup menu whose name starts with "New Song ", or use the numeric keys 0-9 to specify the song number and press the ENTER switch to open the dialog box. Then use the **Set Song Length** menu command (on P4: Track Edit) to specify the number of measures in the song, and press the OK button.

*Note:* You can use **Set Song Length** to change the length of a song at any time. For instance, when creating a new song you might set the length to be somewhat longer than necessary, and then after you have finished recording and editing, use **Set Song Length** to specify the correct length.

**MIDI** If **MIDI Clock** (Global 1-1a) is set to **Internal** (or **Auto**, if no MIDI clocks are being received), changing the song will cause Song Select and Song Position Pointer messages to be transmitted.

If **MIDI Clock** is set to **External MIDI** or **USB** (or **Auto MIDI** or **USB**, if MIDI clocks are currently being received), the KRONOS will change songs in response to received Song Select messages.

**MIDI** When the song changes, tracks whose track **Status** is EXT, EX2 or BTH will transmit Bank Select, Program Change, Volume, Pan, Portamento, Send1, 2, Post IFX Pan, and Post IFX send 1, 2 messages on their respective MIDI channels.

**Track Select[MIDI Track01...MIDI Track16, Master Track, Audio Track01...Audio Track16]**

**MIDI Track 01-MIDI Track 16:** Select the MIDI track that you want to record. This is also where you make your selection when editing a MIDI track in P4: Track Edit.

When **Multi Rec** is off, this also selects the record-enabled track.

When **Multi Rec** is on, the **Play/Rec/Mute** buttons (0-1b, 0-2a) select the record-enabled tracks, regardless of the **Track Select** setting.

Use **Track Name** to give the track a descriptive name.

**MIDI** If other tracks are set to the same MIDI channel as the selected track, and their **Status** is set to INT or BTH, they'll be controlled by the keyboard as well.

Also, if other tracks are set to the same MIDI channel as the selected track, and their **Status** is set to EXT, EX2, or BTH, they'll transmit MIDI to external devices. For another look at this, see the table below.

MIDI Channel	Status	Keyboard plays Internal Sounds	Keyboard Transmits MIDI Out
Same as the selected MIDI Track	OFF	No	No
	INT	Yes	No
	EXT	No	Yes
	EX2	No	Yes
Different from the selected MIDI Track	BTH	Yes	Yes
	Any setting	No	No

If you've selected Master Track or Audio Track 01-16, the settings of the most recently selected MIDI track will be used.

**Master Track:** Select the master track if you want to use the P4: Track Edit page menu commands to edit the master track. You cannot perform realtime recording or step recording on the master track by itself.

**Audio Track 01...Audio Track 16:** Select the audio track you want to record. You will also select one of these when you want to edit an audio track in P4: Track Edit, etc.

In the same way as for MIDI tracks, the data will be recorded on the selected track if you're using single-track recording. If you want to perform multi-track recording, turn on **Multi REC** (0-1a), and use the **Play/Rec/Mute** buttons (0-1b, 0-2a) to select the tracks you want to record.

 You can record up to four audio tracks simultaneously.

**RPPR On/Off [Off, On]**

This turns the RPPR (Realtime Pattern Play/Recording) function on/off. RPPR lets you assign a pattern to each note of the keyboard, so that the pattern will playback (or be recorded) when you press the appropriate key.

**On (checked):** The RPPR function will be on. If a pattern has been assigned to each key in the P5: RPPR Setup page, pressing that key will perform the assigned pattern. For details, see "5-3: RPPR Setup" on page 591.

**Metronome [Only REC, REC & Play, Off]**

**Only REC:** The metronome will sound only during recording.

**REC & Play:** The metronome will sound during recording and playback.

**Off:** The metronome will not sound. However, the pre-count will sound before recording begins.

**Multi REC [Off, On]**

**On (checked):** Multi-track recording setup is enabled. Select this if you want to record two or more tracks simultaneously.



Use MIDI multi-track recording if you want to simultaneously record multiple MIDI tracks of different channels, such as when recording the output of the KARMA or RPPR functions, or when recording from an external multi-track sequencer.

You can also record up to four audio tracks simultaneously.

If the Multi REC box is checked, the **Play/Rec/Mute** status of the track you select in **Track Select** will be set to REC; press the **Play/Rec/Mute** button of the track(s) you want to record so that they indicate REC. (The button indication will change in the order of Play → Rec → Mute.)

Regardless of the **Track Select** (0–1a) setting, data will be recorded on the MIDI tracks and audio tracks that are set to REC. MIDI data will be recorded on the tracks of the matching MIDI channel.

For details on how to record from KARMA or an external multi-track sequencer onto multiple tracks of different MIDI channels, see the Operation Guide: “Using KARMA in Sequencer mode” on page 232, and “Multi-track recording using settings copied from a Combination” on page 234.

*Note:* If you’re recording data from an external multi-track sequencer, set **MIDI Clock** (Global 1–1a) to External MIDI so that the KRONOS will synchronize to your external sequencer. Tempo changes cannot be recorded.

**Off (unchecked):** Single track recording setup will be selected. Recording will occur on the track selected by **Track Select**.

 This cannot be selected if **Recording Setup** is set to Loop All Tracks.

### 0–1b: Track Program Select

#### Selected Track Info

This page displays information about the track you’re editing. If you’ve selected a MIDI track, this shows the bank type, T: MIDI track number/program bank/number/name, Ch: MIDI channel number, RPPR (Assign): the key number that starts the RPPR assigned to the track, and KBD: the MIDI Track number/program bank/number/name that sounds when you play the keyboard.

RPPR (Assign) will not show all of the assignments if there are many RPPR assignments. The P6– Pattern Edit page lets you see all of the assignments.

If you’ve selected an audio track, this shows AT: audio track number/region number of the first audio event/name, [STEREO]: Stereo Pair on/off status, and KBD: The MIDI Track number/program bank/number/name that sounds when you play the keyboard.

#### Gray color and [Inactive] warning in Track Info

 Normally, the numbers for un-selected Tracks use a dark blue background, and a light blue background highlights the selected Track.

If the background is gray, instead, this means that the maximum amount of EXi Fixed Resources has been exceeded, and the EXi Program assigned to the

Track will be muted and inactive. In this case, the Selected Track Info will also show the warning [Inactive] after the Program’s name.

For more information on this subject, including ways to get more out of the system, see “CX-3 & other EXi: Limitations on EXi fixed resources” on page 420.

#### Red color and “Samples Not Loaded” message

 If the Track’s Program uses one or more EXs Multisamples, Samples, or Drum Samples which are not currently loaded, it will not sound correctly. As an indication of this, the Track number’s background turns red, and the message “Samples Not Loaded” will appear at the top of the display. To fix this, load the required EXs sample data.

#### Track 01 (Track Number)

This shows the MIDI track number. The parameters below this let you make settings for the track.

#### Track Category [00...17]

Here you can select a category and sub-category to choose the program used by the MIDI track. All programs are organized into up to 18 categories and 8 sub-categories. Choose the desired category and sub-category, and then choose from the programs within that category.

Press this popup button to access the Category Program Select menu, and choose a program.

For details, see “Category/Program Select” on page 418.

#### Program Select [0...127 (INT and USER Banks), 1...128 (GM Banks)]

Selects the program that will be used by each MIDI track.

The lower line displays part of the program name.

The program you select here will be used when the song is played or recorded from the beginning. If the program is changed while recording, the program change will be recorded as musical data, and the program will change during playback. You can also change the program manually during playback.

However if musical data (program change data) is already recorded, the program will change at that point.

 If the **Status** (2–1a) is either INT or BTH, programs can be selected by receiving MIDI program change messages. Also, when the song is changed or when the song returns to the beginning, tracks whose **Status** is EXT, EX2 or BTH will transmit the bank and program numbers via MIDI. Tracks whose **Status** is EX2 will show Bank as “–” and will transmit the bank number that was selected in the “Bank Select” (2–1b) parameter.

#### Various ways to change the program for a track

- Choose “Program Select,” use numeric keys 0–9 to input a program number, and press the ENTER switch.
- Choose “Program Select,” and turn the VALUE dial or use the  $\Delta/\nabla$  switches.

- If you've chosen "Program Select," the front-panel BANK buttons will change the program bank for the selected track. (If "Program Bank" is selected, the BANK switch LED of the program bank selected for the track will light.)
- Use the Bank/Track Program Select menu to view and select programs by bank.
- Use the Category/Track Program Select menu to view and select programs by category.
- Use the Favorite function; in the Bank/Track Program Select menu or the Category/Track Program Select, you can view and select programs whose "Favorite" setting is turned on.
- Transmit MIDI program change messages from a connected external MIDI device (if the track Status is INT or BTH).
- You can also use the above methods to **switch programs while a song is playing**. If you switch programs while recording, the program change data will be recorded, and the program will switch at that point in the song during playback. You can also use the page menu command "MIDI Event Edit" to add program change data to a track.

### CX-3: Limitations on EXi fixed resources

Under certain circumstances, there may be limitations on the number of particular EXi Programs that you can load simultaneously. For more information, please see "CX-3 & other EXi: Limitations on EXi fixed resources" on page 420.

### Play/Rec/Mute [Play, Rec, Mute]

Use this to mute a MIDI track, or to select the recording tracks for multi-track recording. During playback, or for single-track recording (normal recording), it is possible only to select Play or Mute for tracks (playback tracks) other than the recording track. For multi-track recording, tracks can be set to Play, Rec, or Mute. The setting will alternate each time you press the Play/Rec/Mute button.

**Play:** The track will play.

**Rec:** This will be displayed during single-track recording (normal recording). It cannot be selected.

When you use multi-track recording (when the Preferences page "Multi REC" is on), select REC for the tracks that you wish to record.

**Mute:** The track will be muted (silent).

*Note:* You can use the control surface to control Play/Rec/Mute. You can also make this setting from the front panel mixer section or from the P0- Control Surface page of the LCD. The procedure given below describes how to make these settings from the front panel.

1. Press the CONTROL ASSIGN MIXER TIMBRE/TRACK switch to select tracks 1-8 or 9-16.
2. Use the MIX PLAY/MUTE 1/9 - 8/16 switches to switch the Play/Rec/Mute status of each track. (You can't select REC for single-track recording.)

### Solo On/Off [On, Off]

This turns the Solo function on/off.

Only tracks with SOLO On will sound. Other tracks will be muted.

The setting will alternate on/off each time you press the Solo button.

The operation will depend on the **Exclusive Solo** setting.

**Exclusive Solo off:** Multiple tracks can be soloed. The solo setting of each track will change each time you press its Solo On/Off button.

**Exclusive Solo on:** When you press a Solo On/Off button, only that track will be soloed.

*Note:* You can use the control surface to turn Solo on/off. You can also make this setting from the front panel mixer section or from the P0- Control Surface page of the LCD. The procedure given below describes how to make these settings from the front panel.

1. Press the CONTROL ASSIGN MIXER TIMBRE/TRACK switch to select tracks 1-8 or 9-16.
2. Press the SOLO switch.
3. Use the MIX SELECT 1/9-8/16 switches to turn Solo on/off for each track.

*Note:* The Solo function applies to MIDI tracks 1-16, audio tracks 1-16, audio inputs 1-4, and S/P DIF input L/R.

*Note:* If even one track is being soloed, the SOLO switch LED will blink.

*Tip:* To turn Solo off for all tracks, hold down the RESET CONTROLS switch and press the blinking SOLO switch.

**MIDI** If MIDI tracks whose Status (2-1a) is BTH, EXT, or EX2 are muted by Mute or by the Solo function, note on/off messages will not be transmitted on the MIDI channel selected for those tracks.

**⚠** Solo settings are not saved with the song.

### Recording MIDI Track Pan and Volume

The pan and volume that you specify here will be used when you playback or record from the beginning of the song. If you change the settings during recording, the changes will be recorded as musical data, and pan and volume will change during playback. You can also change the settings during playback. However when the song reaches a location where pan or volume data was recorded, the settings will change accordingly.

### Pan [RND, L001...C064...R127]

This specifies the pan of MIDI track.

**L001...C064...R127:** A setting of L001 is far left and R127 is far right. A setting of C064 will reproduce the oscillator pan setting of the Program mode.

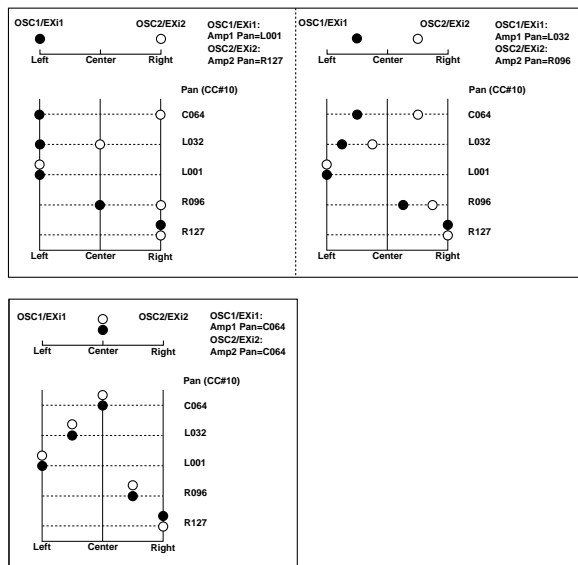

If a mono insert effect is in use, the settings you make here will be ignored. In this case, the “Pan (CC#8)” parameter in P8– Insert FX page will adjust the panning of the sound after the Insert Effect. For details, see “Mixer” on page 874.

**RND:** The pan will change randomly at each note-on.

*Note:* You can use the control surface to adjust the pan. You can also make this setting from the front panel mixer section or from the P0– Control Surface page of the LCD. The procedure given below describes how to make these settings from the front panel.

1. Press the **CONTROL ASSIGN MIXER TIMBRE /TRACK** switch to select tracks 1–8 or 9–16.
2. If you want to control the pan, EQ, and effect send levels of a single track, press the **MIXER KNOBS** switch to select **CHANNEL STRIP**. Then press the **MIX SELECT 1/9–8/16** switch for the track you want to control.

If you want to adjust the pan of tracks 1–8 or 9–16 together, press the **MIXER KNOBS** switch to select **INDIVIDUAL PAN**.

3. If you’ve selected **CHANNEL STRIP**, use the **MIX CHANNEL STRIP Pan (knob 1)** to adjust the pan.

If you’ve selected **INDIVIDUAL PAN**, use the **MIX CHANNEL STRIP** knobs to adjust the pan of tracks 1–8 or 9–16.

You can adjust the knobs in a range of L001 to R127. (You can’t select RND.)

**MIDI** If **Status** (2–1a) is INT or BTH, CC#10 Pan can be received to control the panning. When receiving CC#10, a value of 0 or 1 is far left, 64 is center, and 127 is far right. When you change the song or return to the beginning of the song, tracks whose **Status** is EXT, EX2 or BTH will transmit the pan you specify here as a MIDI message (except for RND).

**Volume [000...127]**

Sets the volume of MIDI tracks 1–16.

*Note:* You can use the control surface to adjust the volume. You can also make this setting from the front panel mixer section or from the P0– Control Surface page of the LCD. The procedure given below describes how to make these settings from the front panel.

1. Press the **CONTROL ASSIGN MIXER TIMBRE /TRACK** switch to select tracks 1–8 or 9–16.
2. Use the **MIX VOLUMES 1/9–8/16** sliders to adjust the volume.

**MIDI** When **Status** (2–1a) is INT or BTH, CC#7 Volume can be received to control the volume. The volume of a track is determined by multiplying the MIDI Volume (CC#7) and Expression (CC#11) values. When you change the song or return to the beginning of the song, tracks whose **Status** is EXT, EX2 or BTH will transmit the volume you specify here as a MIDI Volume message.

**Track 02... 16 (Track Number)**

For more information, please see “Track 01 (Track Number)” on page 516.

**▼ 0–1: Page Menu Commands**

You can use a front-panel shortcut for menu items 0-9. For more information on these shortcuts, see “ENTER + 0-9: shortcuts for menu commands” on page 147.

- 0: **Memory Status**. For more information, see “Memory Status” on page 624.
- 1: **Exclusive Solo**. For more information, see “Exclusive Solo” on page 147.
- 2: **Rename Song**. For more information, see “Rename Song” on page 624.
- 3: **Initialize Song**. For more information, see “Initialize Song” on page 624.
- 4: **Copy From Song**. For more information, see “Copy From Song” on page 624.
- 5: **Load Template Song**. For more information, see “Load Template Song” on page 624.
- 6: **Save Template Song**. For more information, see “Save Template Song” on page 625.
- 7: **FF/REW Speed**. For more information, see “FF/REW Speed” on page 625.
- 8: **Set Location** (for Locate Key.) For more information, see “Set Location (for Locate Key)” on page 626.
- 9: **GM Initialize**. For more information, see “GM Initialize” on page 626.
- 10: **Copy From Combination**. For more information, see “Copy from Combination” on page 626.
- 11: **Copy From Program**. For more information, see “Copy From Program” on page 626.
- 12: **Add to Set List**. For more information, see “Add To Set List” on page 148.

## 0-2: Audio Track Mixer

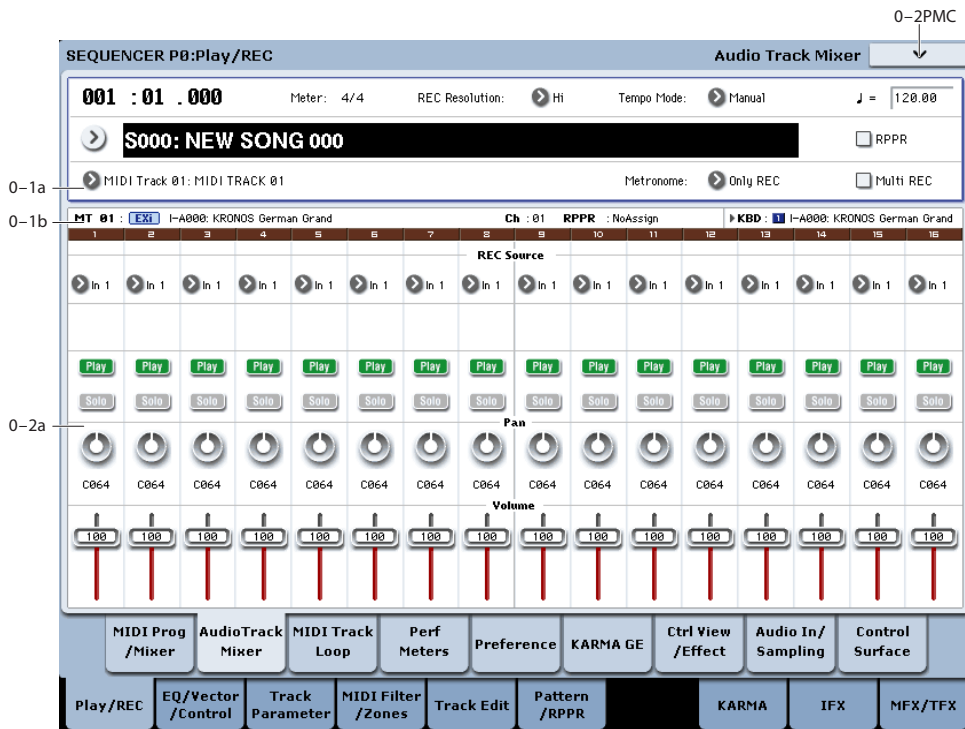

Here you can make settings for recording and playback of audio tracks in the song. You can specify the audio source for recording, and change the Play/Mute status, Solo status, pan, and volume for playback.

affected by the audio input mixer settings. For more information, see the diagram “REC Source = Audio Input 1, 2,” below.

### 0-2a: Audio Track Select

#### Selected Track Info

This displays information about the currently selected MIDI or audio track. For more information, see “0-1b: Track Program Select” on page 516.

#### Track 01 (Track Number)

This indicates the audio track number. The parameters below this track number are the settings for that track.

**REC Source** [(Stereo Pair Off): Audio Input1...2, USB1...2, S/P DIF-L...R, L, R, REC1...4, Indiv.1...4]

[(Stereo Pair On): Audio Input1/2, USB 1/2, S/P DIF L/R, L/R, REC1/2...3/4, Indiv.1/2...3/4]

This selects the source that will be recorded on the track. The signal of the bus line you specify here will be recorded.

The available settings depend on whether or not **Stereo Pair** is enabled for the track.

**Audio Input 1...2 (mono) or 1/2 (stereo):** Choose these to record directly from analog inputs 1-2. The input signal will be recorded directly, without passing through any buses or effects, and without being

## Sequencer mode

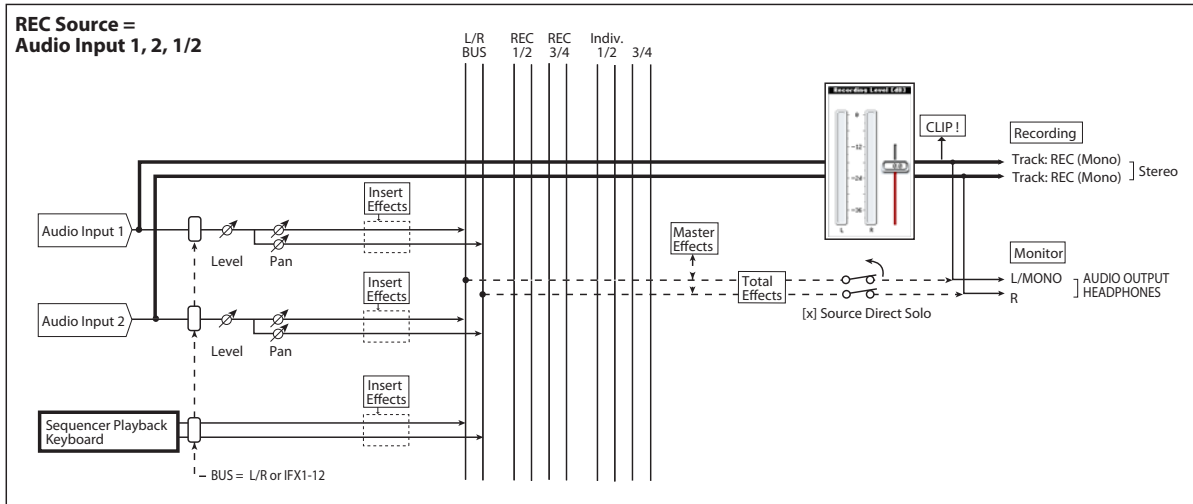

If **Stereo Pair** is on, input 1 is sent to odd-numbered tracks, and input 2 is sent to even-numbered tracks.

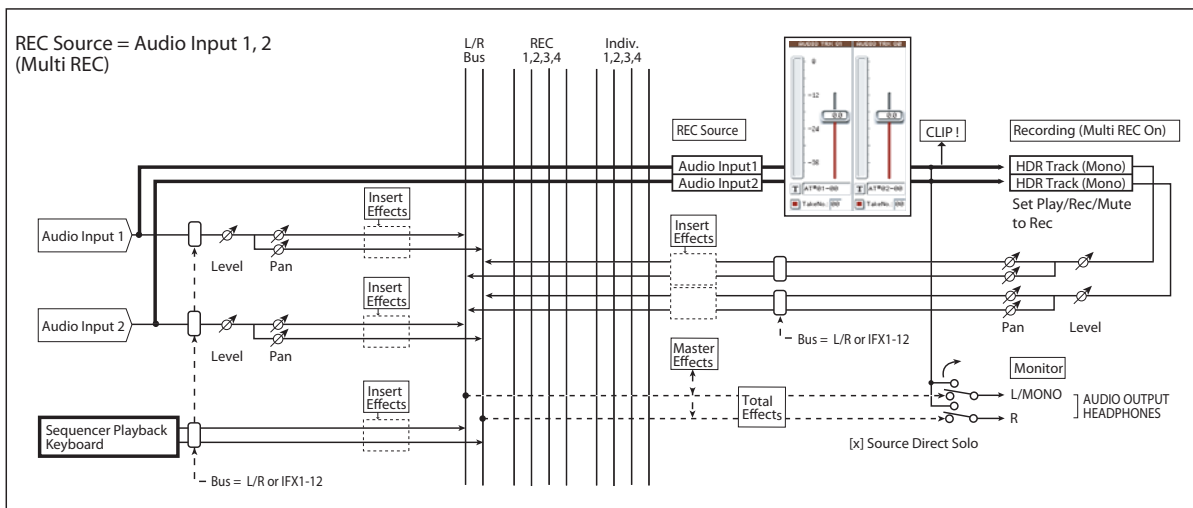

**S/P DIF L or R (mono), S/P DIF L/R (stereo):** Choose these if you want to record the input from the S/P DIF jack. The input from the S/P DIF jack will be recorded directly without passing through the L/R bus, REC buses, or Individual buses. The S/P DIF L,R input will be connected directly, regardless of the Audio Input

(0–8a) settings for **Pan**, “**Level**,” “**Solo**,” and “**Play/Mute**.” See the diagram “**REC = S/P DIF L, R**,” below.

If **Stereo Pair** is on, S/P DIF L is sent to odd-numbered tracks, and S/P DIF IN R is sent to even-numbered tracks.

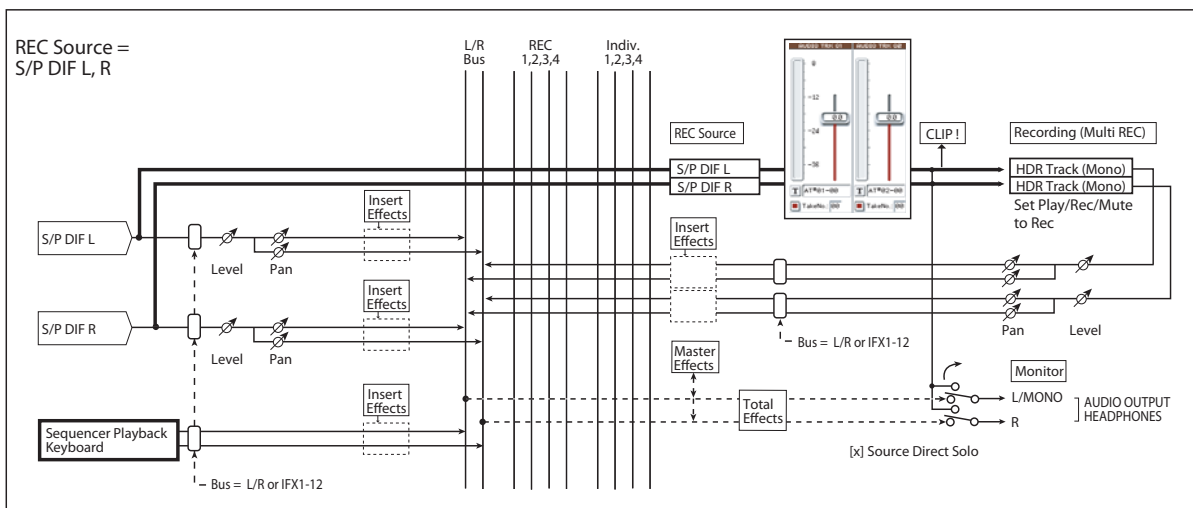



**L, R, L/R:** This is the L/R bus, after passing through both TFX 1 and 2. Choose this if you want to record an external audio signal being sent to the L/R bus (specified by 0-8a), or the sound being produced by

the KRONOS (and sent to the L/R bus) in response to sequencer playback, keyboard playing, or MIDI input. See the diagram "REC Source = L, R," below.

If **Stereo Pair** is on, L is sent to odd-numbered tracks, and R is sent to even-numbered tracks.

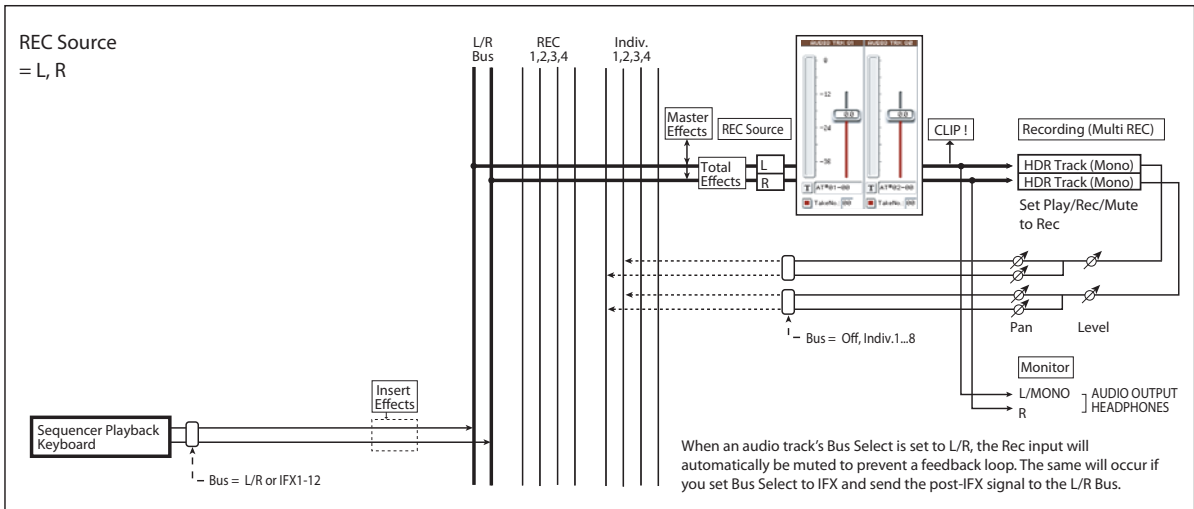

**REC 1, 2, 1/2, REC 3, 4, 3/4:** The REC 1/2 or REC 3/4 buses will be recorded. Choose this if you want to record only the audio input while hearing the sequencer playback and your keyboard playing from the L/R outputs. You can also mix several audio inputs to the REC buses, or use the REC buses to mix the direct sound from the audio inputs with the sound

processed by insert effects, and record the result. For more information, see the diagram "REC Source = REC Bus 1, 2."

If **Stereo Pair** is on, REC Bus 1 (3) is sent to odd-numbered tracks, and REC Bus 2 (4) is sent to even-numbered tracks.

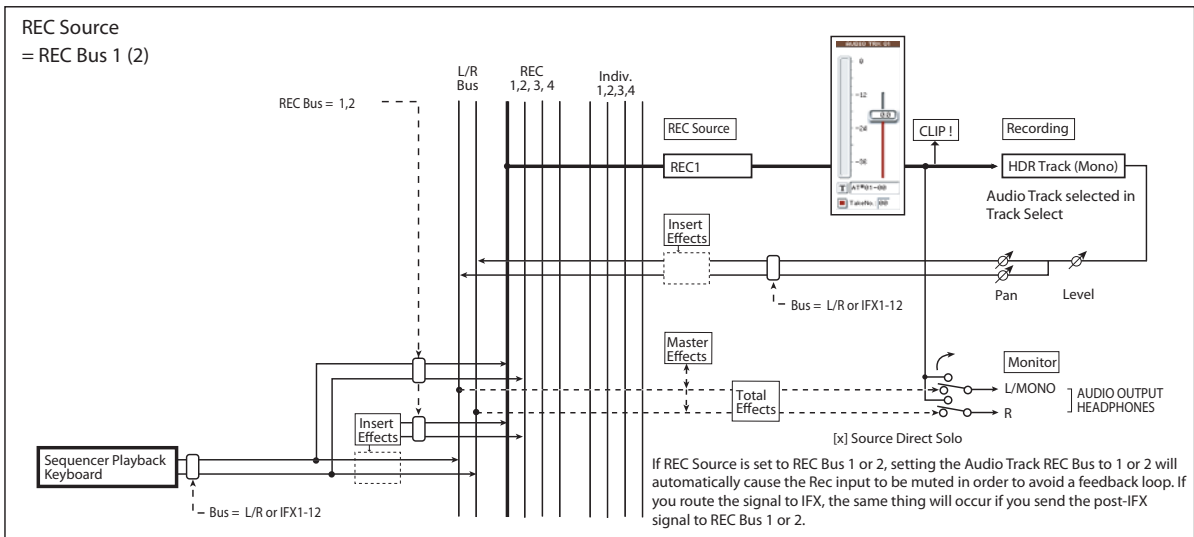

**Indiv.1...4 (mono), Indiv.1/2...3/4 (stereo):** The Indiv.1/2-Indiv.3/4 output buses will be recorded. Similarly to when using the REC buses, you can choose this when you want to monitor the L/R output while recording only the audio input. For more information, see the diagram "REC Source = Indiv. 1, 2 (3, 4)."

If **Stereo Pair** is on and you've selected **Indiv.1/2**, the **Indiv. bus 1** will be sent to odd-numbered tracks, and **Indiv. bus 2** will be sent to even-numbered tracks.

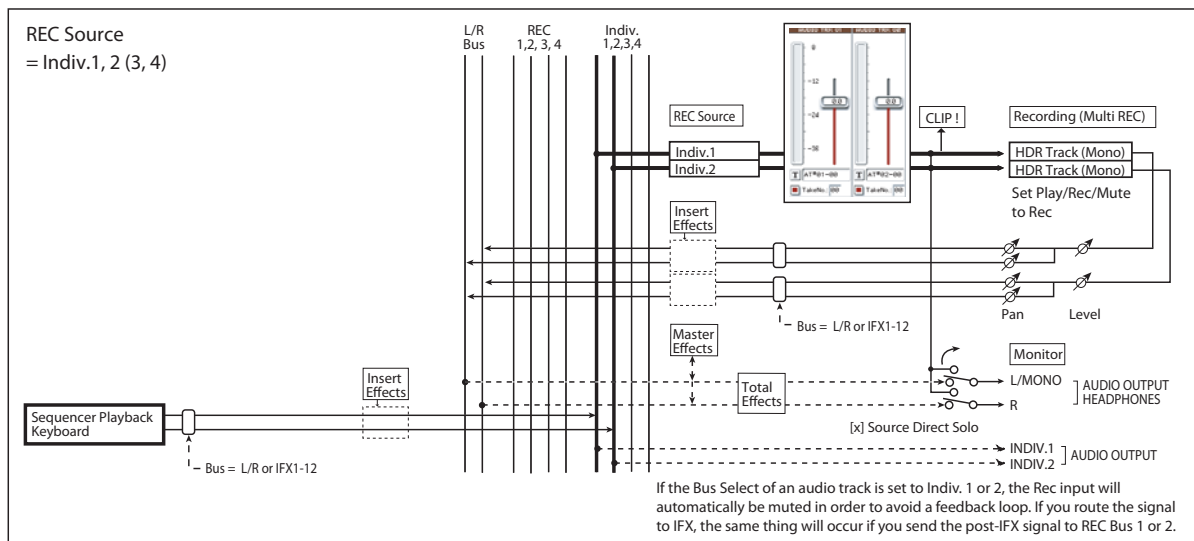

## STEREO

This is shown if **Stereo Pair** is on.

### Play/Rec/Mute [Play, Rec, Mute]

Use this to mute an audio track, or to select the recording tracks for multi-track recording. During playback, or for single-track recording (normal recording), it is possible only to select Play or Mute for tracks (playback tracks) other than the recording track. For multi-track recording, tracks can be set to Play, Rec, or Mute. The setting will alternate each time you press the **Play/Rec/Mute** button.

**Play:** The track will play.

**Rec:** This will be displayed during single-track recording (normal recording). It cannot be selected. When you use multi-track recording (the Preferences page "Multi REC" is on), select REC for the tracks that you wish to record. You can specify REC for up to four tracks.

**Mute:** The track will be muted (silent).

*Note:* You can use the control surface to control Play/Rec/Mute. You can also make this setting from the front panel mixer section or from the P0- Control Surface page of the LCD. The procedure given below describes how to make these settings from the front panel.

1. Press the **CONTROL ASSIGN MIXER AUDIO** switch to select tracks 1-8 or 9-16.
2. Use the **MIX PLAY/MUTE 1/9 - 8/16** switches to switch the Play/Rec/Mute status of each track. (You can't select REC for single-track recording.)

### Solo On/Off [On, Off]

This turns the Solo function on/off.

Only tracks that are set to Solo On will sound. Other tracks will be muted.

The setting will alternate on/off each time you press the Solo button.

The operation will depend on the setting of the **Exclusive Solo** menu command, as described below:

**Exclusive Solo off:** Multiple tracks can be soloed. The solo setting of each track will change each time you press its Solo On/Off button.

**Exclusive Solo on:** When you press a Solo On/Off button, only that track will be soloed.

*Note:* You can use the control surface to turn Solo on/off. You can also make this setting from the front panel mixer section or from the P0- Control Surface page of the LCD. The procedure given below describes how to make these settings from the front panel.

1. Press the **CONTROL ASSIGN MIXER AUDIO** switch to select tracks 1-8 or 9-16.
2. Press the **SOLO** switch.
3. Use the **MIX SELECT 1/9-8/16** switches to turn Solo on/off for each track.

*Note:* The Solo function applies to MIDI tracks 1-16, audio tracks 1-16, audio inputs 1-4, and S/P DIF input L, R.

*Note:* If even one track is being soloed, the SOLO switch LED will blink.

*Tip:* To turn Solo off for all tracks, hold down the **RESET CONTROLS** switch and press the blinking SOLO switch.

Solo settings are not saved with the song.

### Recording Audio Track Pan and Volume

The pan and volume that you specify here will be used when you playback or record from the beginning of the song. If you modify these settings while recording, your changes will be recorded as automation event data on the automation track for each audio track, and the pan and volume data will change accordingly during playback. You can also change the settings during playback. However when the song reaches a location where pan or volume data was recorded, the settings will change accordingly.



**Pan** [L000...C064...R127]

This specifies the pan of audio track.

**L000...C064...R127:** L000 is hard left, and R127 is hard right.

If a mono insert effect is in use, the settings you make here will be ignored. In this case, the "Pan (CC#8)" parameter in P8- Insert FX page will adjust the panning of the sound after the Insert Effect. For details, see "Mixer" on page 874.

*Note:* You can use the control surface to adjust the pan. You can also make this setting from the front panel mixer section or from the P0- Control Surface page of the LCD. The procedure given below describes how to make these settings from the front panel.

1. Press the **CONTROL ASSIGN MIXER AUDIO** switch to select tracks 1-8 or 9-16.
2. If you want to control the pan, EQ, and effect send levels of a single track, press the **MIXER KNOBS** switch to select **CHANNEL STRIP**. Then press the **MIX SELECT 1/9-8/16** switch for the track you want to control the pan.

If you want to adjust the pan of tracks 1-8 or 9-16 together, press the **MIXER KNOBS** switch to select **INDIVIDUAL PAN**.

3. If you've selected **CHANNEL STRIP**, use the **MIX CHANNEL STRIP PAN (knob 1)** to adjust the pan.

If you've selected **INDIVIDUAL PAN**, use the **MIX CHANNEL STRIP** knobs to adjust the pan of tracks 1-8 or 9-16.

You can adjust the knobs in a range of L000 to R127. (Random pan is not available for audio tracks.)

- 🔊 For paired audio tracks, the above parameters are controlled by the odd-numbered audio track. These parameters will not be controlled if you edit the even-numbered audio track. If, however, in the **Stereo Pair** page menu command you set "Pan Mode" to **Index**, the **Pan** of the even-numbered audio track will be valid.

**Volume** [000...127]

Sets the volume of audio tracks 1-16.

*Note:* You can use the control surface to adjust the volume. You can also make this setting from the front panel mixer section or from the P0- Control Surface page of the LCD. The procedure given below describes how to make these settings from the front panel.

1. Press the **CONTROL ASSIGN MIXER AUDIO** switch to select tracks 1-8 or 9-16.
2. Use the **MIX VOLUMES 1/9-8/16** sliders to adjust the volume.

- 🔊 For paired audio tracks, the above parameters are controlled by the odd-numbered audio track. These parameters will not be controlled if you edit the even-numbered audio track.

**Track 02...16 (Track Number)**

For details, see "Track 01 (Track Number)" on page 519.

**▼ 0-2: Page Menu Commands**

You can use a front-panel shortcut for menu items 0-9. For more information on these shortcuts, see "ENTER + 0-9: shortcuts for menu commands" on page 147.

- 0: **Memory Status**. For more information, see "Memory Status" on page 624.
- 1: **Exclusive Solo**. For more information, see "Exclusive Solo" on page 147.
- 2: **Rename Song**. For more information, see "Rename Song" on page 624.
- 3: **Initialize Song**. For more information, see "Initialize Song" on page 624.
- 4: **Copy From Song**. For more information, see "Copy From Song" on page 624.
- 5: **Load Template Song**. For more information, see "Load Template Song" on page 624.
- 6: **Save Template Song**. For more information, see "Save Template Song" on page 625.
- 7: **FF/REW Speed**. For more information, see "FF/REW Speed" on page 625.
- 8: **Set Location** (for Locate Key.) For more information, see "Set Location (for Locate Key)" on page 626.
- 9: **GM Initialize**. For more information, see "GM Initialize" on page 626.
- 10: **Copy From Combination**. For more information, see "Copy from Combination" on page 626.
- 11: **Copy From Program**. For more information, see "Copy From Program" on page 626.
- 12: **Add to Set List**. For more information, see "Add To Set List" on page 148.
- 13: **Stereo Pair**. For more information, see "Stereo Pair" on page 628.
- 14: **Auto HDR/Sampling Setup**. For more information, see "Auto HDR/Sampling Setup" on page 629.

## 0-3: MIDI Track Loop

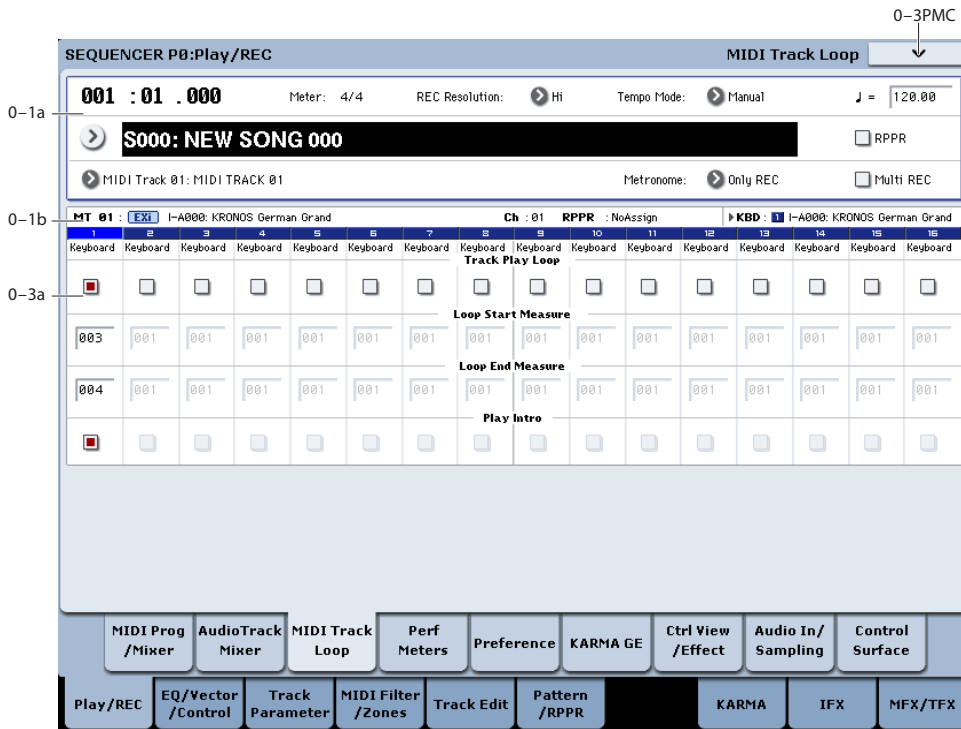

When playing or recording a song, you can independently loop the MIDI tracks.

### 0-3a: Track Select

#### Selected Track Info

This displays information about the currently selected MIDI or audio track. For more information, see “0-1b: Track Program Select” on page 516.

#### Track 01 (Track Number)

**Category** [(00...17)]

Indicates the category.

**Track Play Loop** [Off, On]

Specifies looping for a MIDI track.

**On (checked):** That track will loop between “Loop Start Measure” and “Loop End Measure.”

**Loop Start Measure** [001...999]

Specifies the first measure of the loop.

**Loop End Measure** [001...999]

Specifies the last measure of the loop.

**Play Intro** [Off, On]

**On (checked):** After the measures before the specified “Loop Start Measure” are played once, the region of “Loop Start Measure” – “Loop End Measure” will be played repeatedly.

For example, you can use this on a drum track to make it play a fill-in and then begin looping.

**Off (unchecked):** Playback will begin from the “Loop Start Measure,” and will begin looping immediately.

⚠ This will be valid if “Track Play Loop” is checked and “Loop Start Measure” is set to other than 001.

Example) When “Play Intro” is checked

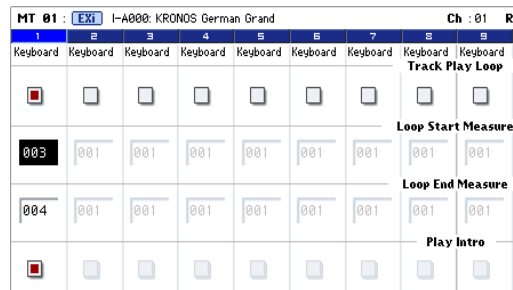

Track 1 will loop as follows.

M001 – M002 – M003 – M004 – M003 – M004 – M003 – M004...

When “Play Intro” is not checked

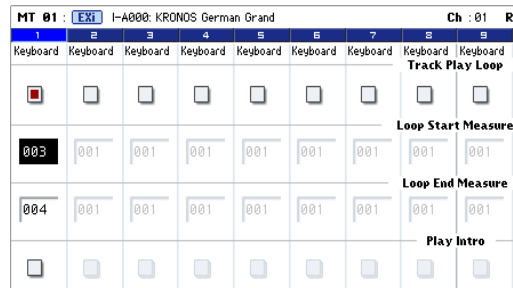

Track 1 will loop as follows.

M003 – M004 – M003 – M004 – M003 – M004 – M003 – M004...

In this way, you can use “Track Play Loop” to make the realtime recording process more efficient.

**Track 02...16 (Track Number)**

For details, see “Track 01 (Track Number)” on page 519.

**▼ 0-3: Page Menu Commands**

You can use a front-panel shortcut for menu items 0-9. For more information on these shortcuts, see “ENTER + 0-9: shortcuts for menu commands” on page 147.

- 0: **Memory Status.** For more information, see “Memory Status” on page 624.
- 1: **Exclusive Solo.** For more information, see “Exclusive Solo” on page 147.
- 2: **Rename Song.** For more information, see “Rename Song” on page 624.
- 3: **Initialize Song.** For more information, see “Initialize Song” on page 624.
- 4: **Copy From Song.** For more information, see “Copy From Song” on page 624.

- 5: **Load Template Song.** For more information, see “Load Template Song” on page 624.
- 6: **Save Template Song.** For more information, see “Save Template Song” on page 625.
- 7: **FF/REW Speed.** For more information, see “FF/REW Speed” on page 625
- 8: **Set Location** (for Locate Key.) For more information, see “Set Location (for Locate Key)” on page 626.
- 9: **GM Initialize.** For more information, see “GM Initialize” on page 626.
- 10: **Copy From Combination.** For more information, see “Copy from Combination” on page 626.
- 11: **Copy From Program.** For more information, see “Copy From Program” on page 626.
- 12: **Add to Set List.** For more information, see “Add To Set List” on page 148.

**0-4: Performance Meters**

This page lets you look at the real-time performance of the KRONOS, including voice usage, voice stealing, and effects.

For more information, see “0-2: Performance Meters” on page 7.

**0-5: Preferences**

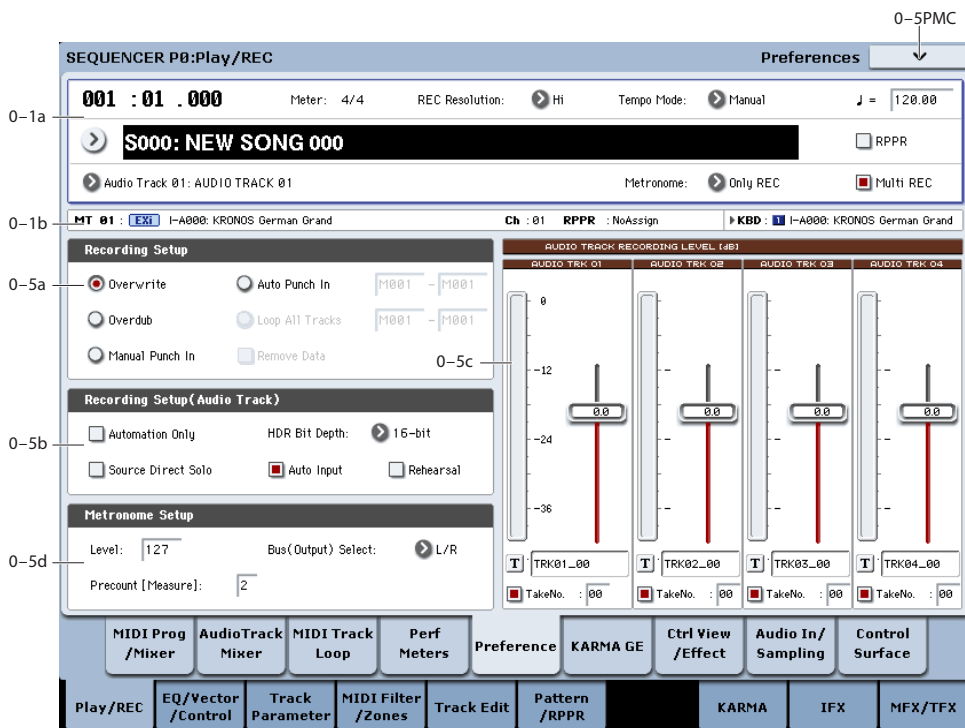

Here you can specify the realtime recording method, adjust levels and make other settings for audio recording, and adjust the metronome settings.

**Selected Track Info**

This displays information about the currently selected MIDI or audio track. For more information, see “0-1b: Track Program Select” on page 516.

## 0–5a: Recording Setup

Selects the method of realtime recording.

For detailed, step-by-step instructions, please see “MIDI recording” on page 76 of the Operation Guide.

### Overwrite

When recording for the first time, you will normally select this method.

To begin recording, press the SEQUENCER REC/WRITE switch and then the SEQUENCER START/STOP switch. To stop recording, press the SEQUENCER START/STOP switch once again.

If you use this method to record on a track that has already been recorded, the result will differ depending on the track or type of event, as follows.

**MIDI Tracks, Audio Track Automation Events:** All data following the measure at which you begin recording will be erased.

**Audio Track Audio Events:** As with Overwrite, only the measures you recorded will be overwritten; the data in subsequent measures will remain unchanged.

### Overdub

Select this method when you wish to add data to a previously-recorded track. (except for audio events)

To begin recording, press the SEQUENCER REC/WRITE switch and then the SEQUENCER START/STOP switch. To stop recording, press the SEQUENCER START/STOP switch once again.

If you use this method to record on a track that has already been recorded, the result will differ depending on the track or type of event, as follows.

**MIDI Tracks, Audio Track Automation Events:** The previously-recorded data will remain, and the newly-recorded data will be added to it.

**Audio Track Audio Events:** As with Overwrite, only the measures you recorded will be overwritten; the data in subsequent measures will remain unchanged.

### Manual Punch In

Select this method when you wish to use the SEQUENCER REC/WRITE switch or a foot switch to re-record selected portions of a previously-recorded track.

Press the SEQUENCER START/STOP switch to playback the song. When you reach the measure at which you wish to begin re-writing the data, press the SEQUENCER REC/WRITE switch or the foot switch, and recording will begin. When you are finished recording, press the SEQUENCER REC/WRITE switch or the foot switch once again, and recording will end.

### Auto Punch In

Select this method when you wish to automatically re-record selected portions of a previously-recorded track.

If you select Auto Punch In, the display will indicate “M\*\*\*–M\*\*\* (Auto Punch In Start Measure–Auto Punch In End Measure)” at the right, allowing you to specify the range of measures that will be rewritten.

Press the SEQUENCER REC/WRITE switch and then the START/STOP switch, and playback will occur until the specified measure is reached. Then, recording will occur only over the specified area (**Start Measure–End Measure**), rewriting it with the newly recorded data.

**Auto Punch In Start Measure** [M001...M999]

**Auto Punch In End Measure** [M001...M999]

When **Recording Setup** is set to Auto Punch In, specify the measures at which recording will start and end.

### Loop All Tracks

Select this method when you wish to repeatedly record a specified area of a track, and continue adding data. This is suitable for creating drum patterns, etc.

If you select Loop All Tracks, the display will indicate “M\*\*\*–M\*\*\* (Loop Start Measure–Loop End Measure)” at the right, allowing you to specify the range of measures that will be recorded repeatedly.

Press the SEQUENCER REC/WRITE switch and then the SEQUENCER START/STOP switch, and playback will occur until the specified measure is reached. Then, recording will occur repeatedly over the specified area (“Loop Start Measure”–“Loop End Measure”).

Previously-recorded data will remain, and the new data will be added. This applies only to MIDI data.

While recording, you can check “Remove Data” to delete unwanted data.

 You can't record audio events to audio tracks while using Loop All Tracks. If you set **Track Select** to an audio track, and leave “Automation Only” (0–5b) unchecked, you won't be able to start recording. Checking “Automation Only” will allow you to start recording so that you can record automation events d. You can use “Remove Data” to delete audio track automation events.

 If **Multi REC** is checked, this parameter will not be available.

**Loop Start Measure** [M001...M999]

**Loop End Measure** [M001...M999]

Specifies the range of measures over which recording will repeat when **Recording Setup** is set to Loop All Tracks.

**Remove Data** [Off, On]

Use this to delete unwanted MIDI data or audio track automation events that you recorded while using Loop All Tracks. This is available when **Recording Setup** is set to Loop All Tracks.

**On (checked):** You can delete unwanted MIDI data while recording with Loop All Tracks. During recording, press the key (note number) that corresponds to the MIDI data you wish to delete. All occurrences of that note number will be deleted for the interval that you continue holding down the key. Controller data can also be erased in a similar way. For example while you move and hold the joystick in the X (horizontal) direction, bender data will be erased. While you apply pressure to the keyboard, after touch data will be erased. This applies to keyboard aftertouch, Joystick+Y (CC#01)–Y (CC#02), Joystick X (Pitch Bend), and Ribbon Controller (CC#16).

Also, you can press and hold down the SEQUENCER REC/WRITE switch to delete all MIDI data for as long as the key is held.

If you want to delete audio track automation events, check “Automation Only” (0–5b), choose Loop All Tracks, and begin recording. Then check “Remove Data” (0–5a) and hold down the SEQUENCER REC/WRITE switch to delete the automation events that occur while you’re holding down that switch.

### 0–5b: Recording Setup (Audio Track)

**Automation Only** [Off, On]

**On (checked):** Only audio track automation events will be recorded. Audio events will not be changed.

**Off (unchecked):** Both audio track automation events and audio events will be recorded.

**Auto Input** [Off, On]

This switches the monitor channel (REC Source/ track playback) for the audio track selected in **Track Select**. See the table that follows.

If “Multi REC” is on, this applies to all tracks whose **Play/Rec/Mute** is set to REC.

**On (checked):** When performing auto/manual punch-in recording, the audio track selected in **Track Select** will be monitored via its **REC Source** during the measures being recorded, and the track playback will be monitored during measures that are not being recorded.

For the audio tracks not selected in **Track Select**, you will always be monitoring the track playback.

When performing auto/manual punch-in recording with “Multi REC” on, audio tracks whose **Play/Rec/Mute** is set to REC will be monitored via **REC Source** during the measures being recorded, and will automatically switch to monitoring the track playback during measures that are not being recorded. For the audio tracks that are not set to REC, you will always be monitoring the track playback.

**Off (unchecked):** The audio track selected in **Track Select** will always be monitored via its “REC Source.” For the audio tracks not selected in **Track Select**, you will always be monitoring the track playback.

If “Multi REC” is on, you will always be monitoring the **REC Source** of audio tracks whose **Play/Rec/Mute** is set to REC.

For the audio tracks that are not set to REC, you will always be monitoring the track playback.

*Audio track monitor channels*

(Line: REC Source, Track: track playback)

	Auto Input	During Stop	During Play	During Rec	During Punch Rec		
					...In	In...Out	Out...
Track Select track	On	Line	Track	Line	Track	Line	Track *
	Off	Line	Line	Line	Line	Line	Line
Tracks other than “Track Select”	On	Track	Track	Track	Track	Track	Track
	Off	Track	Track	Track	Track	Track	Track

**Source Direct Solo** [Off, On]

**On (checked):** Only the signal of the bus line specified by **REC Source** will be output to the L/R jacks and the headphone jack. Check this if you want to monitor only the sound that’s being recorded. When using Multi REC, you’ll hear the sound from the **REC Source** buses whose **Play/Rec/Mute** setting is set to REC.

**Off (unchecked):** The L/R (post-TFX) and bus line signal(s) specified by **Source Bus** will be sent from the L/R jacks and the headphone jack as specified by the Audio Input “Bus Select (IFX/Indiv. Out Bus Select)” (8–3a) and post-IFX **Bus Sel.** (8–5a) settings. This is the normal state.

*Note:* If the **Source Bus** is L/R, this setting is ignored; the L/R (post-TFX) signal is output from the L/R jacks and the headphone jack.

**Rehearsal** [Off, On]

**On (checked):** Recording to the audio track(s) will be simulated (recording will not actually occur).

The monitoring during rehearsal will depend on the “Auto Input” setting. If “Auto Input” is checked, you will monitor the external input between punch-in and punch-out, and monitor the already-recorded sound at other times.

For example if you set punch-in at 005 (measure 5) and punch-out at 008 (measure 8), you will monitor the already-recorded sound during measures 1 to 4 and measures 9 to the end, and monitor the external input during measures 5 to 8.

### 0–5c: Audio Track Recording Level [dB]

**Recording Level, Name, Take, and Take No.** settings for the sixteen audio tracks are not maintained separately for each song; instead, they apply globally to the entire Sequencer mode.

This area displays the settings of the track selected in **Track Select** (for single track recording) or the settings of the tracks whose **Play/Rec/Mute** button is set to REC (for multi-track recording).



Audio Input/Output

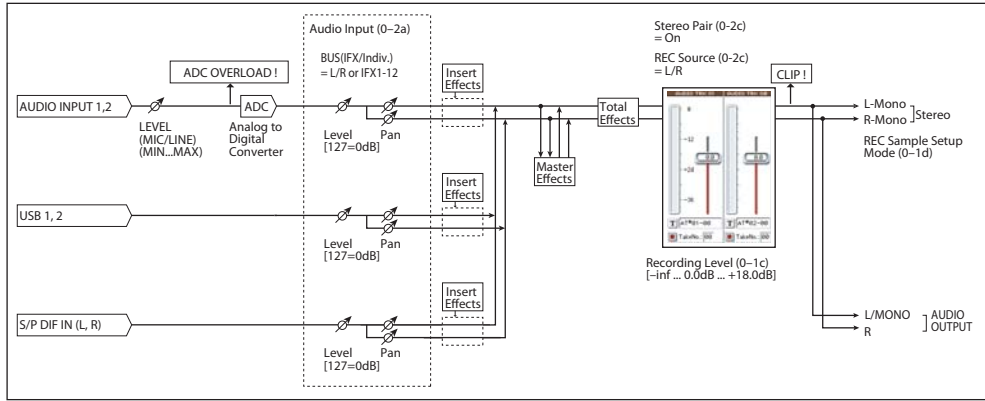

**Audio Tracks 1...4**

**Recording Level 1...4** [-Inf, -72.0...+18.0]

**Level Meter 1...4**

This adjusts the final level of the signal being recorded from the **REC Source** to the audio track. Adjust the level optimally without allowing the level meter to reach the "CLIP !" indication.

The upper part of the level meter/slider shows the corresponding audio track number.

If you're using single track recording, **Recording Level 1** and **Level Meter 1** are valid.

If you're using multi-track recording, the settings for tracks whose "Play/Rec/Mute" is REC will be valid.

When recording a single audio track, the signal level will appear in the level meters as soon as you set **Track Select** to an audio track. When recording multiple audio tracks via Multi REC, the signal levels will appear in the level meters when you press the SEQUENCER REC/WRITE switch to enter record-standby mode.

Use the sliders to adjust the signal levels.

For more information, see "Setting levels" on page 16, "Tips for eliminating distortion when using the analog inputs" on page 17, and "Avoiding extraneous noise" on page 16.

**CLIP ! message**

If 0 dB is exceeded, the display will indicate "CLIP !" This means that the level of the sampling signal is too high, so adjust the level as described under "Setting levels" on page 16.

**ADC OVERLOAD! message**

For more information, please see "CLIP ! message," above.

**Name 1...4**

Here you can specify the names of the regions and WAVE files that will be created when you record audio tracks.

You can use up to eight characters.

If you check **Take** at the right, the take number will automatically be input as the last two characters of the name. For more information, see **Take** (below).

**Take** [Off, On]

**On (checked):** The take number specified by **Take No.** will automatically be assigned as the last two characters in the name of the region and WAVE files that are saved. The number will automatically increment repeatedly after recording. If you are recording repeatedly, you can use the take numbers to manage the separate recordings.

If **Take** is unchecked, you can input up to eight characters as the file name. If it is checked, you can input up to six characters.

**Off (unchecked):** The take number will not be included in the name of the subsequently-recorded region and WAVE files.

**Take No.** [00...99]

This specifies the take number that will be used if **Take** is checked. After each recording, this number will automatically increase by one from the previous take.

**0-5d: Metronome Setup**

Here you can make metronome settings.

**Level** [000...127]

Sets the volume of the metronome.

**Bus (Output) Select** [L/R, L, R, 1...4, 1/2...3/4]

Selects the output destination of the metronome sound.

**L/R, L, R:** Output from OUTPUT (MAIN) L/Mono and/or R.

**1...4, 1/2...3/4:** Output from OUTPUT (INDIVIDUAL) 1-4 respectively.

**Precount [Measure]** [0...2]

Specifies the pre-count that will occur before recording begins.

With a setting of 0, recording will begin the instant you press the SEQUENCER START/STOP switch (after first pressing the SEQUENCER REC/WRITE switch).

**▼ 0-5: Page Menu Commands**

You can use a front-panel shortcut for menu items 0-9. For more information on these shortcuts, see "ENTER + 0-9: shortcuts for menu commands" on page 147.

- **0: Memory Status.** For more information, see "Memory Status" on page 624.

- 1: **Exclusive Solo.** For more information, see “Exclusive Solo” on page 147.
- 2: **Rename Song.** For more information, see “Rename Song” on page 624.
- 3: **Initialize Song.** For more information, see “Initialize Song” on page 624.
- 4: **Copy From Song.** For more information, see “Copy From Song” on page 624.
- 5: **Load Template Song.** For more information, see “Load Template Song” on page 624.
- 6: **Save Template Song.** For more information, see “Save Template Song” on page 625.
- 7: **FF/REW Speed.** For more information, see “FF/REW Speed” on page 625.
- 8: **Set Location** (for Locate Key.) For more information, see “Set Location (for Locate Key)” on page 626.
- 9: **GM Initialize.** For more information, see “GM Initialize” on page 626.
- 10: **Copy From Combination.** For more information, see “Copy from Combination” on page 626.
- 11: **Copy From Program.** For more information, see “Copy From Program” on page 626.
- 12: **Add to Set List.** For more information, see “Add To Set List” on page 148.
- 13: **Stereo Pair.** For more information, see “Stereo Pair” on page 628.
- 14: **Auto HDR/Sampling Setup.** For more information, see “Auto HDR/Sampling Setup” on page 629.

## 0-6: KARMA GE

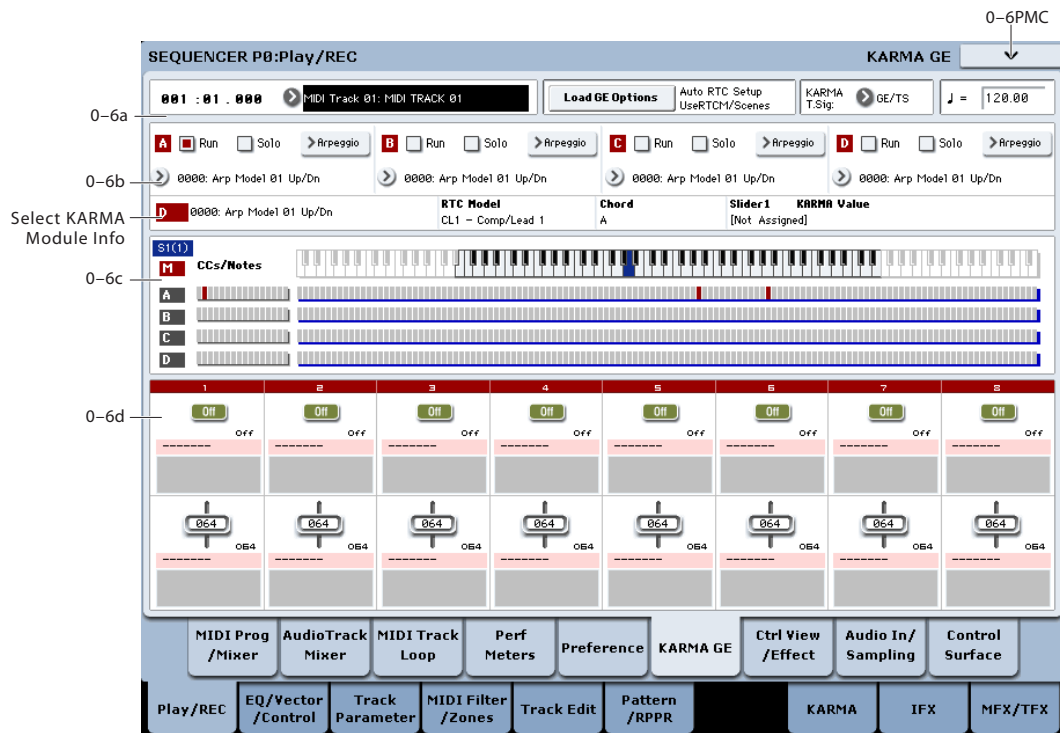

This page gives you an overview of the four KARMA Modules (A-D), and lets you make basic adjustments. For more detailed editing of KARMA parameters, see “Sequencer P7: KARMA” on page 594.

The settings of the KARMA ON/OFF and LATCH switches, KARMA SCENES 1-8 switches, KARMA SLIDERS 1-8, and KARMA SWITCHES 1-8 are saved independently for each Song.

### 0-6a: Location, Track Select, Load GE Options, KARMA T.Sig, Tempo

**Location** [001:01.000...999:16.191]

**Track Select** [MIDI Track01...MIDI Track16, Master Track, Audio Track01...Audio Track16]

**♩ (Tempo)** [040.00...300.00, EXT]

These parameters let you select the current Track, set the location of the sequence, and control the tempo. For more information, see “0-1a: Location, Song/Track Select” on page 513.



**Load GE Options** [Dialogue]

These options let you specify whether the values and assignments for the KARMA SLIDERS and SWITCHES will be set automatically, be initialized, or be preserved when you select a GE. For more information, see “Load GE Options” on page 9.

**KARMA T. Sig (KARMA Time Signature)**  
[GE/TS, 1/4...16/4, 1/8...16/8, 1/16...16/16]

For more information, see “KARMA T.Sig (Time Signature)” on page 10.

**0–6b: GE Select**

**A, B, C, D (Module A, B, C, D)**

**Run** [Off, On]

**Solo** [Off, On]

**GE Select** [Preset 0000...2047, USER–A...L 000...127]

**GE Bank Select** [Preset...USER-L]

**GE Category Select** [Arpeggio...Real-Time]

For more information, please see “0–6b: GE Select” on page 422.

**Selected KARMA Module Info**

**GE Number & Name**

**RTC Model** [List of RTC Models]

**Chord**

**KARMA Value**

For more information, see “Selected KARMA Module Info” on page 423.

**0–6c: Note/CC Activity**

**S (Scene)** [1...8]

The blue square in the upper left of the section shows the current scene of the selected KARMA module.

The number in parentheses is the default Scene.

In Sequencer mode, the default Scene works slightly differently than in Program and Combination modes. Whenever you enter Sequencer mode, or select a Song, the default is set to the current Scene. After that, the default stays the same until you select another Song, or exit Sequencer mode.

If you select a Scene, then go to another Song or change modes, and finally go back to the original Song, the previously-selected Scene will now be the default.

**Module** [M, A...D]

**CCs/Notes and Scan Zones**

These are the same as in Combination mode. For details, see “0–6c: Note/CC Activity” on page 423.

**0–6d: Real-Time Controls**

**KARMA SWITCHES 1...8**

**Current Value 1...8**

**Stored value 1...8**

**Control Timbre Category 1...8**

**Name 1...8**

**KARMA SLIDERS 1...8**

**Current Value 1...8**

**Stored value 1...8**

**Control Timbre Category 1...8**

**Name 1...8**

These are the same as in Combination mode. For details, see “0–6d: Realtime Controls” on page 424.

**▼ 0–6: Page Menu Commands**

You can use a front-panel shortcut for menu items 0-9. For more information on these shortcuts, see “ENTER + 0-9: shortcuts for menu commands” on page 147.

- **0: Memory Status.** For more information, see “Memory Status” on page 624.
- **1: Exclusive Solo.** For more information, see “Exclusive Solo” on page 147.
- **2: Rename Song.** For more information, see “Rename Song” on page 624.
- **3: Initialize Song.** For more information, see “Initialize Song” on page 624.
- **4: Copy From Song.** For more information, see “Copy From Song” on page 624.
- **5: Load Template Song.** For more information, see “Load Template Song” on page 624.
- **6: Save Template Song.** For more information, see “Save Template Song” on page 625.
- **7: FF/REW Speed.** For more information, see “FF/REW Speed” on page 625
- **8: Set Location (for Locate Key.)** For more information, see “Set Location (for Locate Key)” on page 626.
- **9: GM Initialize.** For more information, see “GM Initialize” on page 626.
- **10: Copy From Combination.** For more information, see “Copy from Combination” on page 626.
- **11: Copy From Program.** For more information, see “Copy From Program” on page 626.
- **12: Copy KARMA Module.** For more information, see “Copy KARMA Module” on page 504.
- **13: Initialize KARMA Module.** For more information, see “Initialize KARMA Module” on page 505.
- **14: Copy Scene.** For more information, see “Copy Scene” on page 505.

- 15: **Swap Scene.** For more information, see “Swap Scene” on page 505.
- 16: **Capture Random Seed.** For more information, see “Capture Random Seed” on page 505.
- 17: **Auto Assign KARMA RTC Name.** For more information, see “Auto Assign KARMA RTC Name” on page 506.
- 18: **Add to Set List.** For more information, see “Add To Set List” on page 148.

## 0-7: Controller View/Effect

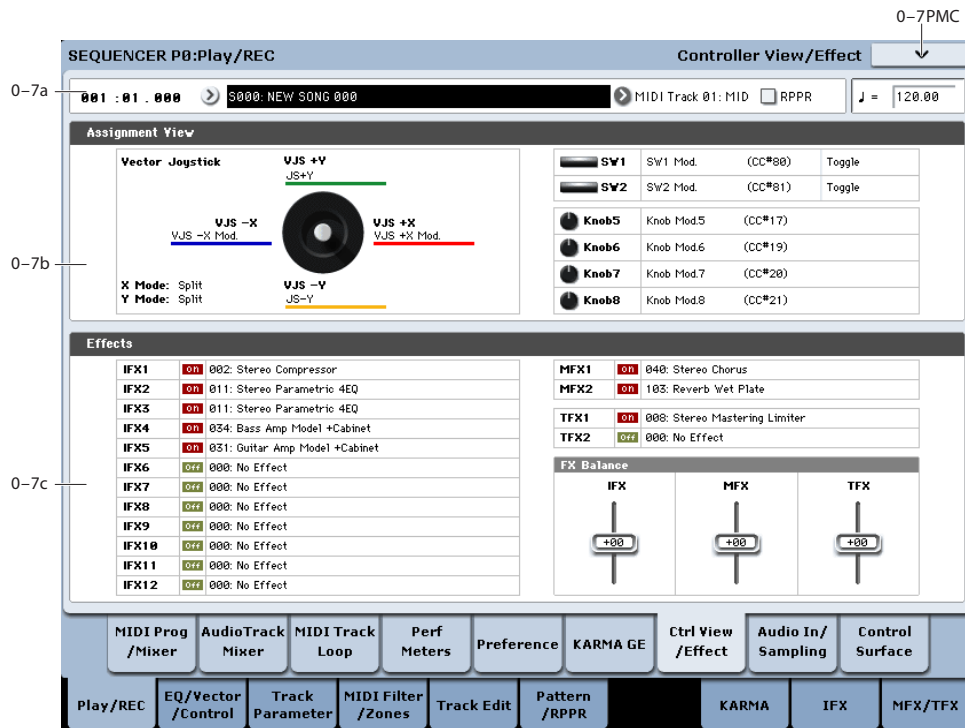

Here you can view the function that is assigned to the vector joystick, SW1 and 2, and knobs 5-8, and view information about the effects. You can also adjust the FX Balance.

### 0-7a: Location, Song/Track Select

**Location** [001:01.000...999:16.191]  
**Song Select** [000...199]  
**Track Select** [MIDI Track01...MIDI Track16, Master Track, Audio Track01...Audio Track16]  
**RPPR** [Off, On]  
**Tempo** [040.00...300.00, EXT]

Select the song whose information you want to view. For more information, see “0-1a: Location, Song/Track Select” on page 513.

### 0-7b: Assignment View

#### VJS

This area shows information about the vector joystick.

**X Mode, Y Mode:** These indicate the behavior of the vector CC for the X-axis and Y-axis. For more information, see “VJS X Mode” on page 447.

**VJS +X, VJS -X, VJS +Y, VJS -Y:** These indicate the controller transmitted by the +X, -X, +Y, and -Y vectors. For more information, see “+X” on page 447.

#### SW1, SW2, Knob5...8

**SW1, SW2:** These indicate the functions assigned to SW1 and 2.

**Knob5...8:** These indicate the functions assigned to knobs 5-8. For more information, see “1-8: Set Up Controllers” on page 451.

### 0-7c: Effects

**IFX1...12, MFX1, 2, TFX1, 2:** This area indicates the effect assigned to each insert effect, master effect, and total effect, and its on/off status.

#### FX Balance

**IFX:** This controls the “Wet/Dry” balance of all insert effects. A setting of +10 is Wet or -Wet, a setting of +0 leaves the settings of the track program, and a setting of -10 is Dry.

**MFX:** This controls the MFX1 and 2 “Return.” A setting of +10 is 127, a setting of +0 leaves the settings of the track program, and a setting of -10 is 000.

**TFX:** This controls the “Wet/Dry” balance of TFX1 and 2. A setting of +10 is Wet or -Wet, a setting of +0 leaves the settings of the track program, and a setting of -10 is Dry.

When you edit, the changes will be immediately reflected in the sound, but will not be saved in the song. Use this when you want to make temporary adjustments to the effect settings of the selected song.

### ▼ 0–7: Page Menu Commands

You can use a front-panel shortcut for menu items 0-9. For more information on these shortcuts, see “ENTER + 0-9: shortcuts for menu commands” on page 147.

- 0: **Memory Status.** For more information, see “Memory Status” on page 624.
- 1: **Exclusive Solo.** For more information, see “Exclusive Solo” on page 147.
- 2: **Rename Song.** For more information, see “Rename Song” on page 624.
- 3: **Initialize Song.** For more information, see “Initialize Song” on page 624.

- 4: **Copy From Song.** For more information, see “Copy From Song” on page 624.
- 5: **Load Template Song.** For more information, see “Load Template Song” on page 624.
- 6: **Save Template Song.** For more information, see “Save Template Song” on page 625.
- 7: **FF/REW Speed.** For more information, see “FF/REW Speed” on page 625
- 8: **Set Location (for Locate Key.)** For more information, see “Set Location (for Locate Key)” on page 626.
- 9: **GM Initialize.** For more information, see “GM Initialize” on page 626.
- 10: **Copy From Combination.** For more information, see “Copy from Combination” on page 626.
- 11: **Copy From Program.** For more information, see “Copy From Program” on page 626.
- 12: **Add to Set List.** For more information, see “Add To Set List” on page 148.

## 0–8: Audio In/Sampling

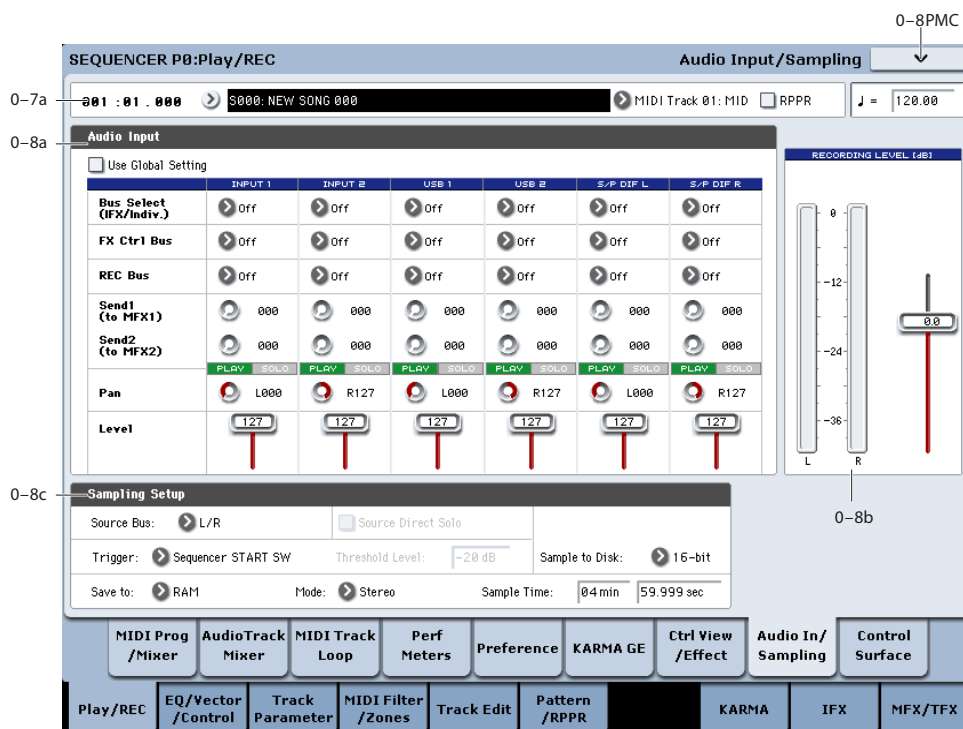

Here you can adjust the settings for the analog/digital audio signal input (AUDIO INPUT, S/P DIF), and the sampling-related settings for Sequencer mode.

In Sequencer mode, the external audio sources you specify here can be recorded to audio tracks or sampled. (You can also record or sample a song that’s played back by the KRONOS or your own playing on the keyboard.) You can also use the KRONOS as a 6-in/6-out effect processor.

You can’t record a Song or pattern while sampling. Nor can you sample while recording a Song or pattern.

### Using the control surface to adjust Audio Inputs

You can use the control surface to adjust the Audio Input **Send1 (to MFX1)**, **Send2 (to MFX2)**, **Play/Rec/Mute**, **Solo On/Off**, **Pan**, and **Level**.

For more information, please see “0–9c: Audio Inputs” on page 25.

The control surface will control the Global mode settings if “Use Global Setting” is On (checked).

## 0–8a: Audio Input

These parameters control the level, pan, play/mute and solo status, send levels, and bus assignments for each of the analog and digital inputs. For more information, see “0–8a: Audio Input” on page 14.

**Use Global Setting** [Off, On]

Each Song can either use the single, Global audio input mixer setup, or have its own custom settings. For more information, see “Use Global setting” on page 14.

### Input 1 & 2

#### USB 1 & 2

#### S/P DIF L & R

**Bus Select (IFX/Indiv. Out Assign)**  
[L/R, IFX1...12, 1...4, 1/2...3/4, Off]

**FX Ctrl Bus (FX Control Bus)** [Off, 1, 2]

**REC Bus** [Off, 1...4, 1/2, 3/4]

**Send1 (to MFX1)** [000...127]

**Send2 (to MFX2)** [000...127]

**Play/Mute** [Play, Mute]

**Solo On/Off** [Off, On]

**Pan** [L000...C064...R127]

**Level** [000...127]

## 0–8b: Recording Level [dB]

These parameters are the same as in Program mode P0– Audio Input/Sampling. For more information, please see “0–8b: Recording Level [dB]” on page 16.

 The final signal level when recording an audio track is set by the P0– Preference page **Recording Level** setting.

**Recording Level** [–Inf, –72.0...+18.0]

The **Recording Level** setting applies to all of Sequencer mode, and is not saved with individual Songs.

## 0–8c: Sampling Setup

Here you can select the source to be sampled, and the method by which to initiate sampling.

Except for “Trigger,” the following parameters are the same as in the Program mode P0– Audio Input/Sampling page. See “0–8c: Sampling Setup” on page 17.

**Sampling Setup** settings are maintained not separately for each song, but as a single set in Sequencer mode.

**Source Bus** [Audio Input1/2, USB 1/2, S/P DIF L/R, L/R, REC1/2...3/4, Indiv.1/2...3/4]

**Source Direct Solo** [Off, On]

**Trigger** [Sampling START SW, Note On, Threshold, Sequencer START SW]

Specifies how sampling will be initiated.

**Sampling START SW:** Pressing the SAMPLING REC switch will cause the KRONOS to enter sampling-standby mode, and sampling will begin when you press the SAMPLING START/STOP switch.

**Note On:** Press the SAMPLING REC switch, and then press the SAMPLING START/STOP switch to enter sampling-standby mode. Sampling will begin when you play the keyboard.

 You can also initiate sampling by receiving a MIDI note-on message instead of playing the keyboard.

**Threshold:** Sampling will begin automatically when the input level exceeds the specified **Level** value. For more information, see “0–8c: Sampling Setup” on page 687.

**Sequencer START SW:** Press the SAMPLING REC switch and then the SAMPLING START/STOP switch to enter sampling-standby mode. Then press the SEQUENCER START/STOP switch to begin sampling. Use this when you want to resample the song playback.

To stop sampling, press the SAMPLING START/STOP switch once again. Sampling will also end if you keep sampling until the time specified by “Sample Time.” For the procedure, see “Trigger” on page 687.

**Metronome Precount** [Off, 4, 8, 3, 6]

**Threshold Level** [–63dB...00dB]

When sampling with **Trigger** set to Threshold, this specifies the level at which sampling will begin. This can be set only when **Trigger** is set to Threshold. See step 3 of the **Trigger** Threshold procedure.

**Save to** [RAM, DISK]

For more information, please see “Save to” on page 19.

**Mode (Sample Mode)** [L-Mono, R-Mono, Stereo]

For more information, please see “Mode (Sampling Mode)” on page 19.

**Sample Time** [min sec]

For more information, please see “Sample Time” on page 20.

**Sample to Disk** [16-bit, 24-bit]

This sets the bit depth for sampling to disk. For more information, please see “Sample to Disk” on page 20.

## ▼ 0–8: Page Menu Commands

You can use a front-panel shortcut for menu items 0-9. For more information on these shortcuts, see “ENTER + 0-9: shortcuts for menu commands” on page 147.

- 0: **Memory Status.** For more information, see “Memory Status” on page 624.

- **1: Exclusive Solo.** For more information, see “Exclusive Solo” on page 147.
- **2: Rename Song.** For more information, see “Rename Song” on page 624.
- **3: Initialize Song.** For more information, see “Initialize Song” on page 624.
- **4: Copy From Song.** For more information, see “Copy From Song” on page 624.
- **5: Load Template Song.** For more information, see “Load Template Song” on page 624.
- **6: Save Template Song.** For more information, see “Save Template Song” on page 625.
- **7: FF/REW Speed.** For more information, see “FF/REW Speed” on page 625
- **8: Set Location (for Locate Key.)** For more information, see “Set Location (for Locate Key)” on page 626.
- **9: GM Initialize.** For more information, see “GM Initialize” on page 626.
- **10: Copy From Combination.** For more information, see “Copy from Combination” on page 626.
- **11: Copy From Program.** For more information, see “Copy From Program” on page 626.
- **12: Optimize RAM.** For more information, see “Optimize RAM” on page 148.
- **13: Select Sample No.** This applies only when **Save to** is set to **RAM**. For more information, see “Select Sample No.” on page 149.
- **14: Select Directory/File for Sample to Disk.** This applies only when **Save to** is set to **Disk**. For more information, see “Select Directory” on page 149.
- **15: Auto HDR/Sampling Setup.** For more information, see “Auto HDR/Sampling Setup” on page 629.
- **16: Bounce All Tracks To Disk.** For more information, see “Bounce All Tracks To Disk” on page 635.
- **17: Add to Set List.** For more information, see “Add To Set List” on page 148.

## 0–9: Control Surface

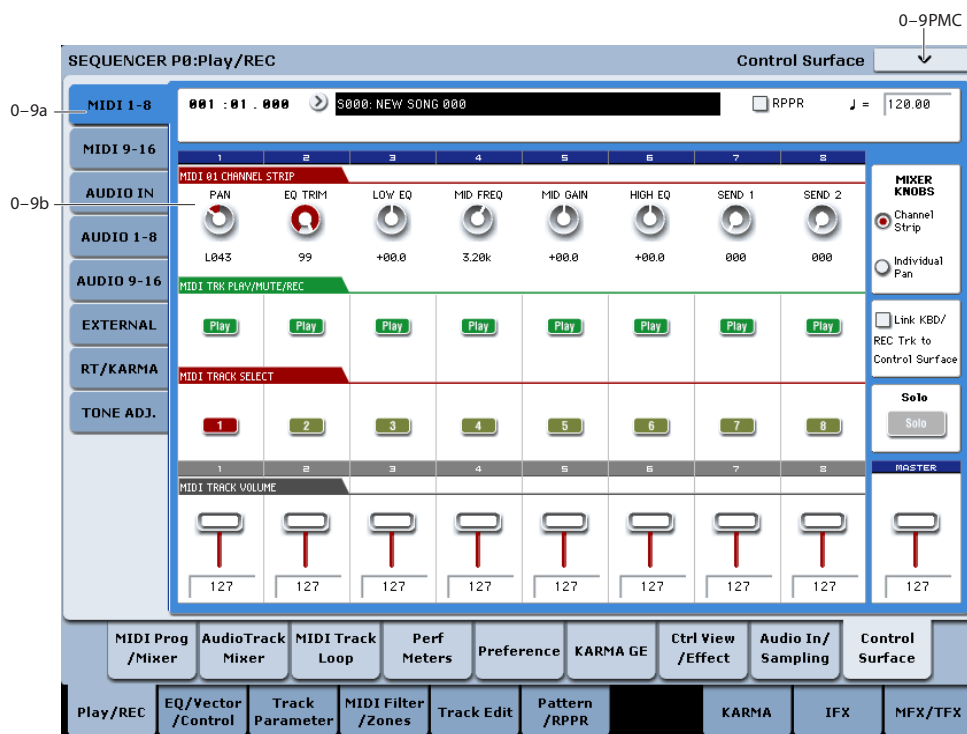

The Control Surface is the set of 9 sliders, 8 knobs, and 16 switches to the left of the LCD display. It looks like a mixer, but it can do other things as well, including editing sounds, controlling KARMA, and sending MIDI messages to external devices.

This page shows you the current values for each of the sliders, knobs, and buttons, along with information about what they are controlling. For instance, you can:

- Adjust the volume and pan for all 16 MIDI Tracks and 16 Audio Tracks
- Control each Track’s EQ settings and Master Effects Send levels
- Modulate sounds and effects using the Real Time Knobs
- Control KARMA, and select KARMA scenes, using the sliders and switches
- Edit sounds using Tone Adjust
- Assign sliders, knobs, and switches to different Tone Adjust parameters

- Select the Keyboard Track and the HDR Audio record track

For more information about the Control Surface, see:

- “Jump/Catch” on page 22
- “RESET CONTROLS” on page 22

**Local Control On/Off and the Control Surface**

The Control Surface generates and receives MIDI CCs and System Exclusive messages, so that you can record knob, switch, and slider movements into a sequencer. This means that the Global mode **Local Control** setting is important:

- If **Local Control** is On, the physical Control Surface will work properly as long as MIDI is **not** being looped back into the KRONOS.
- If **Local Control** is Off, you **must** loop back MIDI into the KRONOS in order for the physical Control Surface to work properly.
- Regardless of the **Local Control** setting, you can always edit Control Surface parameters via the touch-screen.

For more information, see “Local Control and the Control Surface” on page 771.

**Control Assign Switches and Tabs**

You can switch the Control Surface between its different functions using either the tabs on the left side of the LCD display, or the front-panel Control Assign switches. The tabs and the front-panel switches mirror one another; when you change one of them, the other changes as well.

In Sequencer mode, you can select one of six different functions:

**TIMBRE/TRACK** lets you adjust the volume, pan, EQ, and send levels for each of the 16 Tracks, eight at a time. The LEDs to the right of the switch show whether you’re currently editing Tracks 1-8 or 9-16; press the **TIMBRE/TRACK** button to toggle between the two.

If you switch to one of the other Control Assign modes, and then go back to **TIMBRE/TRACK**, it will automatically return to the previously selected group (1-8 or 9-16).

The **AUDIO** button lets you control both the HDR Audio Tracks, and the Audio Inputs. The LEDs to the right of the switch show whether you’re currently editing HDR Tracks 1-8, HDR Tracks 9-16, or the Audio Inputs; press the **AUDIO** button repeatedly to step through the three options.

As with **TIMBRE/TRACK** above, the Control Surface remembers your last selection under **AUDIO**. If you switch to one of the other Control Assign modes, and then go back to **AUDIO**, it will automatically return to the previously selected group.

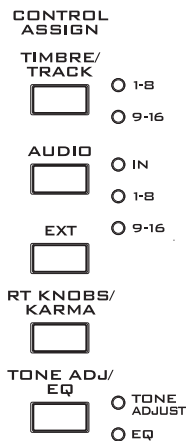

**AUDIO HDR 1-8 and HDR 9-16** let you adjust the volume, pan, EQ, and send levels for each of the 16 hard-disk Audio Tracks, eight at a time.

**AUDIO INPUTS** lets you adjust the volume, pan, and send levels for the analog, USB, and S/P DIF audio inputs.

**EXTERNAL** lets you send MIDI messages to external MIDI devices.

**R.TIME KNOBS/KARMA** lets you modulate sounds and effects with the knobs, and control KARMA with the sliders and switches.

**TONE ADJ./EQ** lets you edit Programs within the context of the Song, and without making any changes to the original Program data. You also get hands-on access to these edits, using the sliders, knobs, and switches.

You can freely change back and forth between the different functions, without losing any of your edits.

**0-9a: Song Select & Tempo**

This section duplicates the most important information from the main Play page.

**Song** [000...127]

This is the current Song.

**Tempo** [040.00...300.00, EXT]

This is the tempo for the current Song, which applies to KARMA, tempo-synced LFOs and Wave Sequences, and so on.

**EXT** means that the tempo will sync to external MIDI clocks.

**040.00...300.00** allow you to set a specific tempo in BPM, with 1/100 BPM accuracy.

**0-9b: MIDI Tracks 1-8 and 9-16**

These Control Assign settings lets you adjust the volume, pan, EQ, and FX send settings for MIDI Tracks 1-8 and 9-16.

**Mixer Knobs** [Channel Strip, Individual Pan]

The Mixer Knobs switch is on the front panel, immediately to the right of the knobs, and is also duplicated in the on-screen display. The eight knobs can control two different sets of parameters, depending on the setting of this switch.

**Channel Strip:** With this setting, the eight knobs will control the Pan, EQ, and FX Send settings for the selected Track. Use the **TIMBRE/TRACK** button to select a group of 8 Tracks (1-8 or 9-16), and then use the **SELECT** buttons to choose the specific Track.



**Individual Pan:** With this setting, the knobs will control the Pan for the current group of Tracks. Knob 1 controls the pan for Track 1 (or 9), knob 2 controls the pan for Track 2 (or 10), and so on.



**Knobs 1–8, Channel Strip**

When the Mixer Knobs switch is set to Channel Strip, the knobs provide quick access to the Pan, EQ, and FX Send parameters. The Pan and EQ parameters duplicate the similarly-named parameters found on the Song editing pages; changing them here will change them in the editing pages, and vice-versa.

**Pan [Random, L001...C064...R127]**

This controls the stereo pan of the selected Track. A setting of **L001** places the sound at the far left, **C064** in the center, and **R127** to the far right.

**Random** is available only via the LCD. (Otherwise, it would be difficult to use the knob to sweep smoothly from left to right.) With the **Random** setting, each note will have a different, random pan position.

Note: With some EXi instruments, such as the CX-3, notes cannot be panned individually. For these EXi, **Random** pan will move all sounding notes to a different pan position at each note-on.

**EQ Trim [00...99]**

This controls the volume level going into the EQ.

High settings of the Low, Mid, and High Gain controls can cause substantial increases in the overall level. You can compensate for this by turning down the input trim.

 Note: if the EQ page EQ Bypass parameter is turned On, then none of the EQ parameters here will have any effect.

**Low EQ [-18.0...+00.0...+18.0dB]**

This controls the gain of the 80Hz Low Shelf EQ, in increments of 0.5dB.

**Mid EQ Freq [100Hz...10kHz]**

This sets the center frequency for the Mid sweep EQ.

**Mid EQ Gain [-18.0...+00.0...+18.0dB]**

This controls the gain of the Mid Sweep EQ, in increments of 0.5dB.

**High EQ [-18.0...+00.0...+18.0dB]**

This controls the gain of the 10kHz High Shelf EQ, in increments of 0.5dB.

**Send 1 [000...127]**

This controls the send level into FX Send 1. If the Track's **Output Bus** parameter is set to L/R or OFF, it scales the Oscillator send levels. If the **Output Bus** is set to IFX 1–12, it directly controls the post-IFX send levels.

**Send 2 [000...127]**

This controls the send level into FX Send 2. For more details, see **Send 1**, above.

**Knobs 1/9–8/16, Individual Pan**

When the Mixer Knobs switch is set to Individual Pan, the knobs will control the Pan for the current group of Tracks. Knob 1 controls the pan for Track 1, knob 2 controls the pan for Track 2, and so on.

These duplicate the Song's Track Pan parameters; changing them here will change them in the editing pages, and vice-versa.

**Pan 1/9 [Random, L001...C064...R127]**

This controls the stereo pan of either Track 1 or Track 9, depending on whether the **TIMBRE/TRACK** button is set to 1–8 or 9–16.

A setting of **L001** places the sound at the far left, **C064** in the center, and **R127** to the far right.

**Random** is available only via the LCD. (Otherwise, it would be difficult to use the knob to sweep smoothly from left to right.) With the **Random** setting, the pan position will be different for each note-on.

Note: with some EXi sounds, such as the CX-3, **Random** pan may affect all notes at once.

**Pan 2/10–8/16 [Random, L001...C064...R127]**

These control the stereo pan of Tracks 2–8 or 10–16, depending on the setting of the **TIMBRE/TRACK** button. For more details, see **Pan 1/9**, above.

**Play/Mute switches 1/9–8/16**

The top row of switches allow you to turn each of the Tracks on and off.

**Play/Mute 1/9 [Off, On]**

This controls the play/mute status of either Track 1 or Track 9, depending on whether the **TIMBRE/TRACK** button is set to 1–8 or 9–16.

When this switch is on (LED = on), Track 1 will play. When the switch is off (LED = off), Track 1 will be muted.

**Play/Mute 2/10–8/16 [Off, On]**

These control the play/mute status of Tracks 2–8 or 10–16, depending on the setting of the **TIMBRE/TRACK** button.

For more details, see **Play/Mute 1/9**, above.

**Solo switch and Select switches 1/9–8/16****Solo [Off, On]**

Solo lets you isolate one or more MIDI Tracks, HDR Audio Tracks, or Audio Inputs, so that you hear them by themselves. It does this by temporarily muting all non-soloed Tracks and Inputs.

Solo uses the Select switches. These switches can show and control either which Track is currently selected, or which Tracks are soloed. The main Solo button lets you switch back and forth between the two views.

When the Solo button is **Off** (LED = Off), the Select switches select the current Track; when the Solo button is **On** (LED = On or blinking), the Select switches let you solo one or more Tracks.

When Solo is **On**, and one or more Tracks or Audio Inputs are soloed, the Solo LED will blink on and off to remind you that solo is in use.

**NOTE:** The main Solo button merely changes the functions of the Select switches. It does not enable or clear the individual solo states.



### Clearing all solos

To turn off **Solo** for all MIDI Tracks, Audio Tracks, and Audio Inputs at once:

1. Press and hold the **RESET CONTROLS** button.
2. While holding **RESET CONTROLS**, press the **SOLO** button.

### Exclusive Solo menu parameter

The menu's **Exclusive Solo** parameter also affects the way that Solo works. When **Exclusive Solo** is **Off** (unchecked), you can solo multiple Tracks and inputs at once.

When **Exclusive Solo** is **On** (checked), only one MIDI Track, HDR Track, or Audio Input can be soloed at a time. In this mode, pressing a Solo switch automatically disables any previous solos.

On most pages, you can also toggle **Exclusive Solo** by holding **ENTER** and pressing **1** on the numeric keypad.

### Select 1/9–8/16 [Off, On]

These buttons either select or solo the Track, depending on the state of the **Solo** switch. For more details, see **Solo**, above.

You can link these Select buttons to the Keyboard Track selection, so that you can switch between playing the different tracks simply by pressing their front-panel buttons. For more information, see “Link KBD/REC Trk to Ctrl Surface,” below.

### Link KBD/REC Trk to Ctrl Surface [Off, On]

This on-screen check-box links the Select buttons to the Keyboard Track (for MIDI tracks) and the Rec track (for HDR audio tracks).

When the box is checked, and **CONTROL SELECT** is set to **TIMBRE/TRACK**, pressing the Select buttons will change the Keyboard Track, and vice-versa.

Also, when **CONTROL SELECT** is set to **AUDIO HDR** 1–8 or 9–16, pressing the Select buttons will change the audio record track, and vice-versa.

### Volume Sliders 1/9–8/16

These sliders adjust the volume level of the Tracks.

#### Volume 1/9 [000...127]

This controls the volume of either Track 1 or Track 9, depending on whether the **TIMBRE/TRACK** button is set to 1–8 or 9–16.

#### Volume 2/10–8/16 [000...127]

These control the volume of Tracks 2–8 or 10–16, depending on the setting of the **TIMBRE/TRACK** button. For more details, see **Volume 1/9**, above.

### Master Volume Slider

#### Master Volume [000...127]

This controls the volume of the main stereo outputs, after the Total Effects. It does not affect Individual Outputs 1–4.

### Master Volume

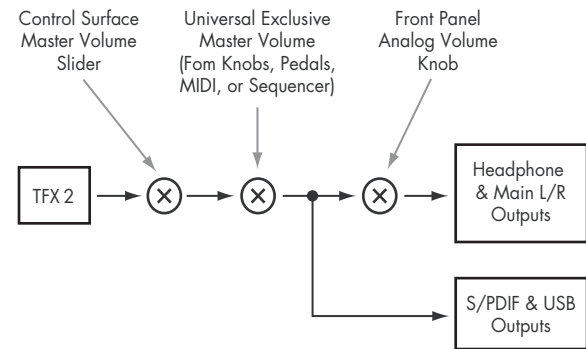



### 0-9c: Audio Inputs

This Control Assign setting lets you adjust the volume, pan, and FX send settings for each of the six audio inputs: analog 1/2, USB 1/2, and S/P DIF left and right.

You can use this page to mix sounds from other sources into the KRONOS outputs—as an on-stage submixer, for instance.

#### Use/Edit Global Setup [Off, On]

Songs can use the single, Global audio input mixer setup, or can instead have their own custom settings.

When **Use/Edit Global Setup** is **On**, the Song uses the Global settings. This is the default, and lets you change freely between different Programs and Song without affecting the audio inputs.

Also, any edits made on this page will affect the Global setting, along with any other Programs, Combis, or Songs which use the Global setting.

On the other hand, it may sometimes be convenient to save a particular mixer setup with an individual Song, to set up special sub-mixer settings or effects processing for particular inputs. In this case, set **Use/Edit Global Setup** to **Off**, and the audio inputs will use the Song's custom settings.

#### Mixer Knobs [Channel Strip, Individual Pan]

This switch controls whether the knobs show the pan settings for all 6 inputs at once (Individual Pan), or the pan and FX Send levels for the selected input (Channel Strip). For more information, please see "Mixer Knobs" on page 538.

#### Knobs 1-8, Channel Strip

When the Mixer Knobs switch is set to Channel Strip, the knobs provide quick access to the selected input's Pan and FX Send parameters.

#### Pan [L000...C064...R127]

This controls the stereo pan of the selected input. A setting of **L000** places the sound at the far left, **C064** in the center, and **R127** to the far right.

#### Send 1 [000...127]

This controls the send level into FX Send 1. If the input's **Output Bus** parameter is set to L/R or OFF, it scales the programmed send level. If the **Output Bus** is set to IFX 1-12, it directly controls the post-IFX send levels, overwriting any previous setting.

#### Send 2 [000...127]

This controls the send level into FX Send 2. For more details, see "Send 1," above.

#### Knobs 1-6, Individual Pan

When the Mixer Knobs switch is set to Individual Pan, knobs 1-6 control pan for each of the audio inputs. Knobs 7 and 8 have no effect.

#### Audio Input Pan (1-6) [L000...C064...R127]

Knobs 1 and 2 control the pan settings for analog inputs 1 & 2, knobs 3 and 4 control the pan for USB inputs 1 & 2, and knobs 5-6 control the pan for the left and right S/P DIF inputs. A setting of **L000** places the sound at the far left, **C064** in the center, and **R127** to the far right.

#### Play/Mute switches 1-6

The top row of switches allow you to mute any or all of the audio inputs.

#### Play/Mute (1-6) [Off, On]

When this switch is on (LED = on), the input will be enabled. When the switch is off (LED = off), the input will be muted.

**Solo switch and Select switches 1-6**

**Solo** [Off, On]

Solo lets you isolate one or more MIDI Tracks, HDR Audio Tracks, or Audio Inputs, so that you hear them by themselves. It does this by temporarily muting all non-soloed Tracks and Inputs.

The Select switches can show and control either which Input is currently selected, or which Inputs are soloed. The main Solo button lets you switch back and forth between the two views.

When the Solo button is **Off** (LED = Off), the Select switches select the current Input; when the Solo button is **On** (LED = On or blinking), the Select switches let you solo one or more Inputs.

When Solo is **On**, and one or more Tracks or Audio Inputs are soloed, the Solo LED will blink on and off to remind you that solo is in use.

**NOTE:** The main Solo button merely changes the functions of the Select switches. It does not enable or clear the individual solo states.

For more information, see “Clearing all solos” on page 537, and “Exclusive Solo menu parameter” on page 537.

**Select (1-6)** [Off, On]

This switch either selects or solos the input, depending on the Solo switch setting. For more details, see “Solo,” above.

**Volume Sliders 1-6**

**Audio Input Volume (1-6)** [000...127]

These sliders adjust the volume levels of the audio inputs.

**Master Volume Slider**

**Master Volume** [000...127]

This controls the volume of the main stereo outputs, after the Total Effects. It does not affect Individual Outputs 1-4. For more information, see the diagram “Master Volume” on page 537.

Control Surface - Audio Tracks

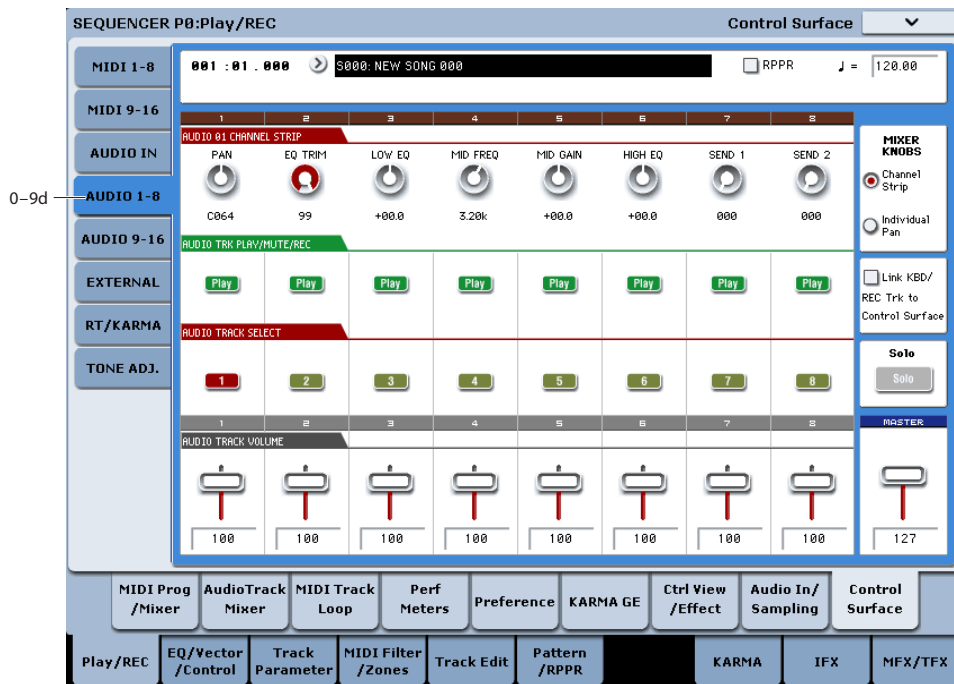

**0-9d: Audio 1-8 and 9-16**

These Control Assign settings let you control the volume, pan, EQ, and send levels for each of the 16 Audio Tracks, eight at a time.

Except for Pan, the audio track mixer functions identically to the MIDI Track mixer, as described under “0-9b: MIDI Tracks 1-8 and 9-16” on page 535.

Pan is slightly different for audio tracks: hard left is L000 (as opposed to L001), and the Random setting is not available.

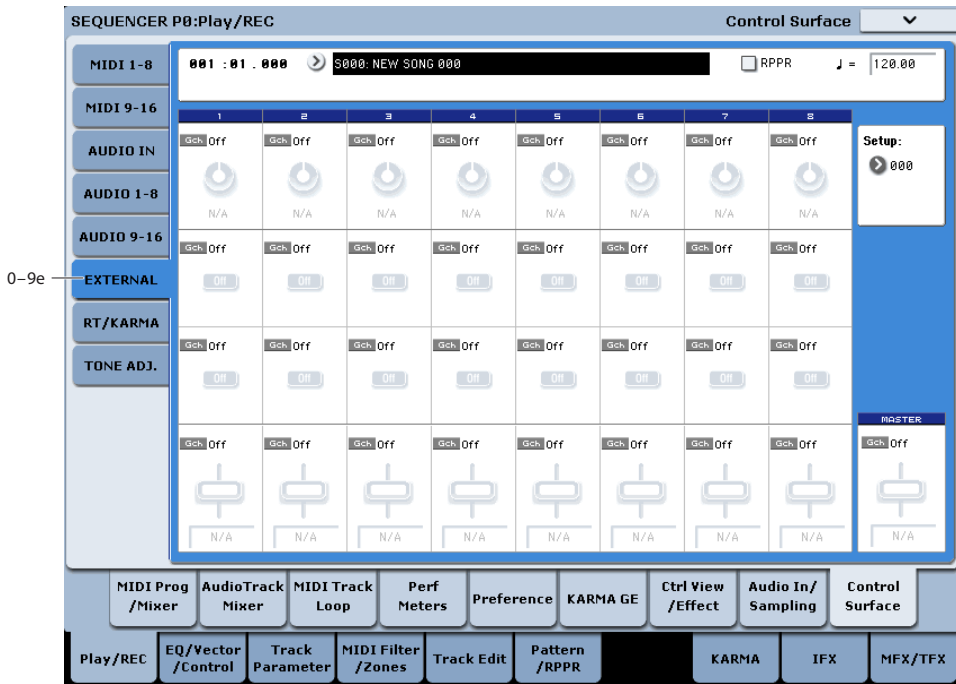

**0-9e: External**

This Control Assign setting lets you send MIDI messages to external devices. Each slider, knob, and switch can be assigned to a separate MIDI controller and MIDI channel. The eight pads also have separate assignments which apply only when Control Assign is set to External.

For instance, you might make one setup for controlling several different pieces of MIDI gear on stage, another for controlling a software synthesizer (such as one of Korg’s Legacy Collection synths), and so on.

These assignments are determined by the selected External Setup. The KRONOS has 128 External Setups, which can be edited in Global mode (see “1-2: External 1” on page 777).

When you select an External Setup, it stays selected even when you change Songs or switch to another mode. This makes it easy to select different KRONOS sounds without disrupting external MIDI control, and vice-versa.

You can think of External mode as being a separate control surface which just happens to share KRONOS’s sliders, knobs, switches, and pads.

**Setup** [000...127]

This selects the External Setup for the knobs, sliders, switches, and pads.

*Note:* this selection is persistent for the entire KRONOS; is not stored with the Song.

**Knobs 1-8**

**MIDI Channel (1-8)** [01...16, Gch]

This read-only parameter shows the MIDI Channel assigned to the knob. Each can send on a different channel, if desired.

Gch means that the knob will transmit on the Global MIDI Channel, as set in Global mode. This allows you to re-direct any number of sliders, knobs, switches, and pads to a different channel at once, without editing the individual controls.

**CC# Assign (1-8)** [Off, 000...119]

This read-only parameter shows the MIDI CC sent by the knob.

*Note:* to change the mapping of CCs to controls, edit the External Setups in Global P1-2: External 1. For more information, see “1-2: External 1” on page 777.

**Value (1-8)** [000...127]

This is the current value of the knob’s MIDI CC.

**Switches 1-16**

**MIDI Channel (1-16)** [01...16, Gch]

This read-only parameter shows the MIDI Channel for the switch. Each can send on a different channel, if desired.

Gch means that the slider will transmit on the Global MIDI Channel, as set in Global mode.

**CC# Assign (1-16)** [Off, 000...119]

This read-only parameter shows the MIDI CC sent by the switch.

**Switch On/Off (1-16)** [Off, On]

When the switch is turned on, it sends a value of 127; when it is turned off, it sends a value of 0.

**Sliders 1-8 & Master Slider**

**MIDI Channel (1-8)** [01...16, Gch]

This read-only parameter shows the MIDI Channel for the slider. Each can send on a different channel, if desired.

**Gch** means that the slider will transmit on the Global MIDI Channel, as set in Global mode.

**Value (1-8)** [000...127]  
This is the current value of the slider's MIDI CC.

**CC# Assign (1-8)** [Off, 000...119]

This read-only parameter shows the MIDI CC sent by the slider.

Control Surface - RT/KARMA

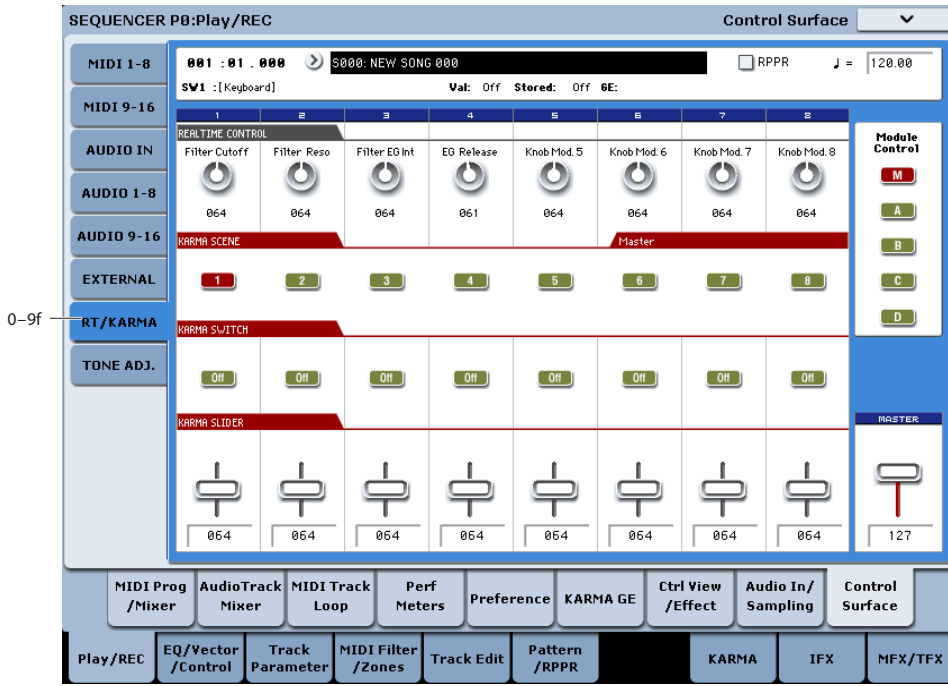

**0-9f: RT (Real Time Knobs)/KARMA** AMSource

This Control Assign setting lets you modulate Program and Effects parameters with the eight knobs, and control KARMA with the switches and sliders.

**Selected parameter information**

When you select a KARMA Slider or Switch, this area shows detailed information about its KARMA parameter assignments.

**Control** [(SW1...8, SL1...8)]

This shows which Switch or Slider is currently selected.

**Assignment** [Name]

Each KARMA Slider or Switch can control multiple internal parameters simultaneously. The group of parameters can be given a single name, which is shown here.

You can select different names, if desired. For more information, see "7-9: Name/Note Map" on page 132

**Module and Parameter** [A...D 01...32, P 01...08]

This read-only display shows the KARMA parameter(s) assigned to the Slider or Switch.

**A, B, C,** and **D** mean that the slider or switch controls a GE Real-Time Parameter from the corresponding KARMA Module. The following number identifies the specific parameter within the module. For instance, **A22** is parameter 22 of Module A.

**P** means that the switch is controlling a Performance Real-Time Parameter.

You can assign many parameters to a single slider or switch, if desired. Due to space limitations, however, only the first five parameters will be shown here.

To change the parameter assignments, use the KARMA GE RTP and Perf RTP pages. For more information, please see "7-5: GE Real-Time Parameters/Scenes" on page 120, and "7-6: Perf Real-Time Parameters" on page 123.

**Parameter Value** [Depends on parameter]

This shows the value of the GE or Performance Real-Time Parameters assigned to the selected Slider or Switch. The range can vary, depending on the individual parameters.

**KARMA Module Control**

**Module Control** [M, A, B, C, D]

When used to control KARMA, the Control Surface sliders and switches are five layers deep: one for each Module (A-D), and a Master Layer capable of controlling selected parameters from all of the Modules at once. Each layer has its own Slider, Switch, and Scene settings.

The **Module Control** radio buttons (and the front-panel **MODULE CONTROL** button) let you switch between these five layers.

To select a different layer, just press its on-screen radio button, or use the front-panel **MODULE CONTROL** button to step through each layer in turn. When you do so, all of the KARMA Sliders, Switches and Scenes will update instantly to show their current values and names within the selected layer.

**Knobs 1–8**

Knobs 1–4 all have dedicated functions which correspond to MIDI CCs. Knobs 5–8 can be assigned to a wide variety of functions, many of which also have corresponding MIDI CCs.

When you move the knob, it will send the corresponding MIDI CC to the current Keyboard Track, and also to all Tracks on the same MIDI Channel as the Keyboard Track. (To edit individual Programs, use Tone Adjust instead.)

Also, when the CC is received via MIDI or generated by KARMA, the knob value will change to match the CC value.

Note that the Knob 1–8 settings of the individual Programs do not apply in Sequencer mode.

Unless otherwise noted, “scaling” means that the parameters are at their programmed values when the controller is at 64, at their minimum when the controller is at 0, and at their maximum when the controller is at 127. For another look at this, see the diagram below.

*CC scaling of parameters*

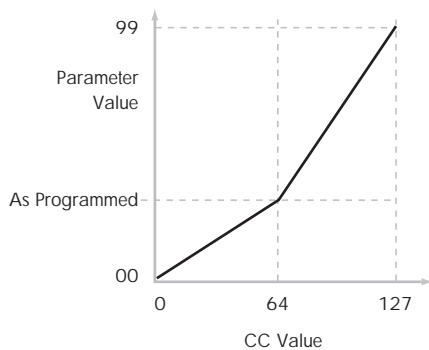

**Knob 1: CUTOFF (CC#74) [000...127]**

This knob scales the cutoff frequencies of Filters A and B, and transmits and receives MIDI CC #74.

**Knob 2: RESONANCE (CC#71) [000...127]**

This knob scales the resonance of Filters A and B, and transmits and receives MIDI CC #71.

**Knob 3: Filter EG Intensity (CC#79) [000...127]**

This knob scales the effect of the Filter EG on the cutoff frequencies of Filters A and B. It also transmits and receives MIDI CC#79.

**Knob 4: EG Release (CC#72) [000...127]**

This knob scales the release time of the Filter and Amp EGs, and transmits and receives MIDI CC#72.

**Knobs 5–8 [000...127]**

You can set knobs 5–8 to a wide variety of modulation functions, using the Controller Setup page (P1–8).

Many of the functions scale a particular set of Program parameters. All of the settings also correspond to MIDI messages—usually CCs.

**KARMA SCENES 1-8**

A KARMA Scene includes the settings for all of the KARMA Sliders and Switches. Each Song can contain up to eight Scenes.

To select a Scene, just press its switch - you’ll see all of the KARMA Sliders and Switches update instantly to their new values.

**KARMA SWITCHES 1-8**

These switches control KARMA Performance or GE (Generated Effect) Real-Time Parameters, as assigned on the KARMA Perf RTP and GE RTP pages.

**Karma Sliders 1-8**

These sliders control KARMA Performance or GE Real-Time Parameters, as assigned on the KARMA Perf RTP and GE RTP pages.

**Master Volume Slider**

**Master Volume [000...127]**

This controls the volume of the main stereo outputs, after the Total Effects. It does not affect Individual Outputs 1–4. For more information, see the diagram “Master Volume” on page 537.



Control Surface - Tone Adjust

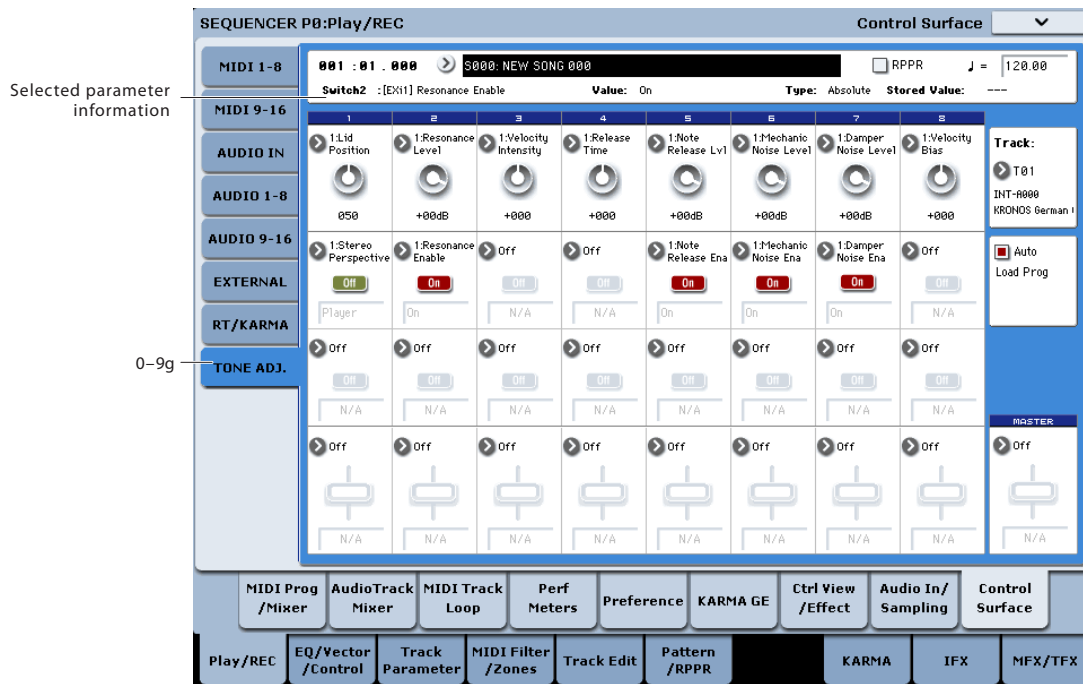

### 0–9g: Tone Adjust

Tone Adjust provides two important features simultaneously:

- It lets you use all of the sliders, knobs, and switches to control Program parameters - like the knobs on an analog synth, or the drawbars on an organ.
- It lets you modify Programs for use within a specific Song, including everything from subtle tweaks (like changing LFO speeds) to dramatic changes (such as selecting a different Multisample). Any changes that you make are stored with the Song, and do not alter the original Program.

Each of the sixteen Tracks has its own set of tone adjust parameters, but only one Track is shown at a time.

For more information, see:

- “Tone Adjust and MIDI SysEx” on page 30
- “Interaction between Tone Adjust and MIDI CCs” on page 30
- “Absolute, Relative, and Meta parameters” on page 30

#### Saving Tone Adjust Edits

In Program mode, when you make edits via Tone Adjust and then save the results, the Program data is changed—just as if you’d edited the internal parameters directly. For more information, see “Saving Tone Adjust Edits” on page 30.

In Sequence mode, however, all Tone Adjust edits are stored within the Song; the Program itself is not changed. This lets you alter the way that a Program sounds in one specific Song without affecting the way that it sounds in Program mode, or in any other Combis or Songs.

### Track select

#### Track

[1...16]

This selects the Track whose Tone Adjust parameters appear on the screen and the Control Surface. You can switch back and forth between the different Timbres as much as you like, without losing your edits.

This parameter is the same as the selected Track in TIMBRE/TRACK mode; changing one will also change the other.

You can use a shortcut to change the current Track directly from the Control Surface, without leaving Tone Adjust mode:

1. Press and hold the TONE ADJ./EQ button.
2. While holding TONE ADJ./EQ, press a PLAY/MUTE or SELECT button to select a Track.

The PLAY/MUTE buttons select Tracks 1–8, and the SELECT buttons select Tracks 9–16.

3. Release the TONE ADJ./EQ button.

The Control Surface and screen will change to show the Tone Adjust parameters for the newly selected Track.

#### Auto Load PRG

[Off, On]

When you first load a Program into a Track, this parameter determines whether or not the Program’s Tone Adjust settings will be loaded as well.

These settings include the parameters assigned to each slider, knob, and switch, along with the on/off state of any Switches assigned to Absolute parameters.

Note that any edits you’ve made using Tone Adjust in Program mode will already have been stored into the Program’s parameters. This means that the Program will still sound the same, whether or not you load the Tone Adjust settings.



Once the Program has been loaded, you can change any or all of the Tone Adjust settings as desired, including both assignments and values. All such edits are stored in the Song, without affecting the original Program.

If **Auto Load PRG** is **On**, Tone Adjust settings will be automatically loaded along with the Program.

If **Auto Load PRG** is **Off**, then the relationship between the types of the old and new Programs will determine what happens, as shown in the table below:

<b>If the old Program is...</b>	<b>And the new Program is...</b>	<b>Then Tone Adjust parameters and values are...</b>
An HD-1 Program	An HD-1 Program	kept the same
An HD-1 Program	An EXi Program	loaded from the new Program
Any EXi Program	An HD-1 Program	loaded from the new Program
An EXi Program	An EXi Program with the same EXi assigned to the same slots as the previous Program	kept the same
An EXi Program	An EXi Program which does <b>not</b> use the same EXi as the previous Program	loaded from the new Program

**Selected parameter information**

This status line shows detailed, read-only information about the currently selected Tone Adjust parameter.

**(Control)** [Knob1...8, SW1...16, Slider1...8, Slider M]

This is the physical controller assigned to the Tone Adjust parameter. **Slider M** is the Master Slider.

**(Assignment)** [Full Parameter Name]

This shows the full name of the parameter assigned to the controller. You can change this using the "Assign" parameter, below.

**Value** [Current Parameter Value]

This shows the current value of the parameter. The range of values will vary depending on the parameter assigned to the control.

**Type** [Relative, Absolute, Meta]

This shows the type of the parameter, which relates to how edits to the parameter are saved. For more information, see "Absolute, Relative, and Meta parameters" on page 30.

**Stored Value** [Original Parameter Value]

This shows the original value of the parameter, before the effects of Tone Adjust. It applies only to Tone Adjust parameters which control a single Program parameter.

If you un-assign a parameter from a control, it will revert to this value.

**Knobs 1-8**

**Assign** [List of Tone Adjust assignments]

This lets you assign a Tone Adjust parameter to the knob.

The first group of parameters are the Common set, which are supported by most Program types. For a full list, see "Common Tone Adjust Parameters" on page 438.

After the Common parameters, the items in the list will vary depending on the Program type. For more information, please see:

"HD-1 Tone Adjust Parameters," on page 33.

"AL-1: Tone Adjust," on page 222.

"CX-3: Tone Adjust," on page 244.

"STR-1: Tone Adjust" on page 292.

"MS-20EX Tone Adjust parameters" on page 319

"PolysixEX Tone Adjust parameters" on page 335.

Other EXi instruments will have their own set of parameters, as described in their manuals.

**Assignments are exclusive**

Each controller can be assigned to only one parameter, and each parameter can be assigned to only one controller.

To swap a parameter from one control to another, you'll need to first un-assign it from the old control, and then assign it to the new control.

**Value** [Depends on parameter]

This shows the current value of the parameter. The range of values will vary depending on the parameter assigned to the control.

**Switches 1-16**

Tone Adjust switches act a little differently than knobs and sliders.

When a switch is assigned to a **Relative** parameter, or an **Absolute** parameter with more than two states:

Switch On = **On Value** (see below)

Switch Off = the Program's stored value

When a switch is assigned to a two-state **Absolute** parameter, such as **Hold**, the switch status directly reflects the parameter value:

Switch On = **On**

Switch Off = **Off**

**Assign** [List of Tone Adjust assignments]

This lets you assign a Tone Adjust parameter to the switch. For more information, see "Assign," above.

**On Value** [Depends on parameter]

The parameter is set to this value when the switch is On.

When the switch is assigned to a two-state **Absolute** parameter, such as **Hold**, this will always be the same as the **Switch Status** (see below).

**Switch Status** [Off, On]

This simply shows whether the switch is On or Off. The status is also shown by the LEDs in the physical buttons.

**Sliders 1–8 and Master Slider**

These work identically to Knobs 1–8, as described above.

**▼ 0–9: Page Menu Commands**

You can use a front-panel shortcut for menu items 0-9. For more information on these shortcuts, see “ENTER + 0-9: shortcuts for menu commands” on page 147.

- 0: **Memory Status**. For more information, see “Memory Status” on page 624.
- 1: **Exclusive Solo**. For more information, see “Exclusive Solo” on page 147.
- 2: **Rename Song**. For more information, see “Rename Song” on page 624.
- 3: **Initialize Song**. For more information, see “Initialize Song” on page 624.
- 4: **Copy From Song**. For more information, see “Copy From Song” on page 624.
- 5: **Load Template Song**. For more information, see “Load Template Song” on page 624.
- 6: **Save Template Song**. For more information, see “Save Template Song” on page 625.
- 7: **FF/REW Speed**. For more information, see “FF/REW Speed” on page 625.
- 8: **Set Location** (for Locate Key.) For more information, see “Set Location (for Locate Key)” on page 626.
- 9: **GM Initialize**. For more information, see “GM Initialize” on page 626.
- 10: **Copy From Combination**. For more information, see “Copy from Combination” on page 626.
- 11: **Copy From Program**. For more information, see “Copy From Program” on page 626.
- 12: **Copy Tone Adjust**. This is available only when **Control Assign** is set to **Tone Adjust**. For more information, see “Copy Tone Adjust” on page 503.
- 13: **Reset Tone Adjust**. This is available only when **Control Assign** is set to **Tone Adjust**. For more information, see “Reset Tone Adjust” on page 503.
- 14: **Copy Scene**. This is available only when **Control Assign** is set to **RT KNOBS/KARMA**. For more information, see “Copy Scene” on page 157.
- 15: **Swap Scene**. This is available only when **Control Assign** is set to **RT KNOBS/KARMA**. For more information, see “Swap Scene” on page 157.
- 16: **Add to Set List**. For more information, see “Add To Set List” on page 148.

# Sequencer P1: EQ/Vector/Controller

## 1-1: MIDI Track EQ

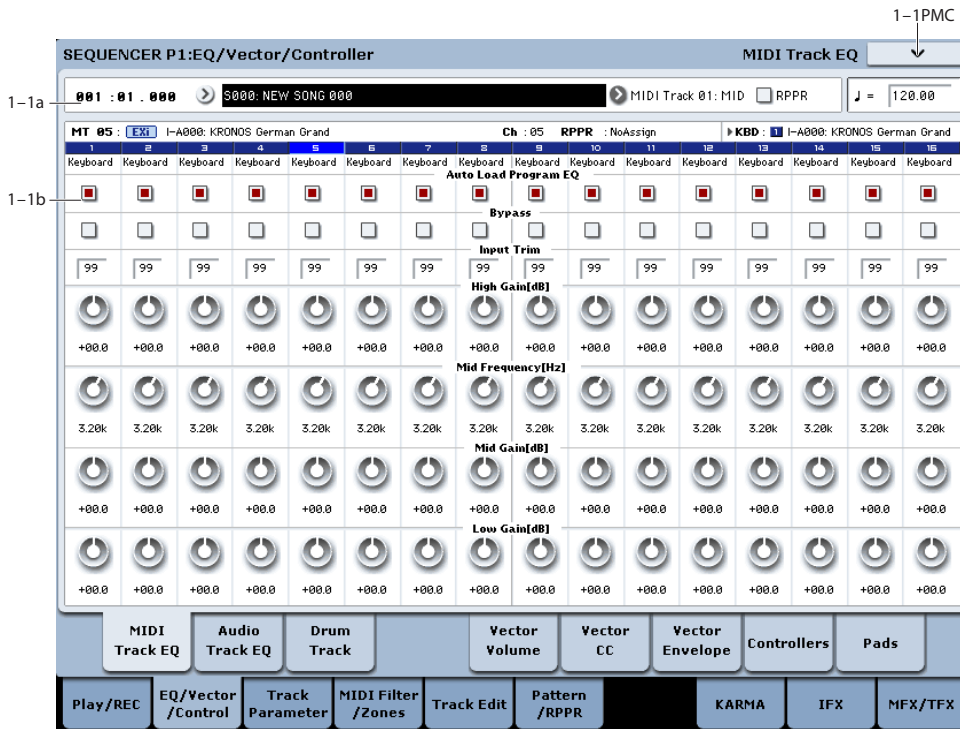

Each Track has a dedicated three-band EQ, with sweepable mid band. This page lets you view and adjust the settings for all 16 MIDI Tracks at once.

### 1-1a: Location, Song/Track Select

**Location** [001:01.000...999:16.191]

**Song Select** [000...199]

**Track Select** [MIDI Track01...MIDI Track16, Master Track, Audio Track01...Audio Track16]

**RPPR** [Off, On]

**♩ (Tempo)** [040.00...300.00, EXT]

For more information, please see "0-1a: Location, Song/Track Select" on page 513.

### 1-1b: 3 Band Parametric EQ

Selected Track Info	MT 01 : EX1 I-A000: KRONOS Germa
Track Number	1 2 3 4
Track Category	Keyboard Keyboard Keyboard Keyboard

#### Selected Track Info

This page displays information about the track that's selected for editing. If you've selected a MIDI track, this shows the bank type, T: MIDI track number/program bank/number/name, Ch: MIDI channel number, RPPR (Assign): the key number that

starts the RPPR assigned to the track, and KBD: the bank/number/name of the program that will sound when you play the keyboard.

If you've selected an audio track, this shows the AT: audio track number/region number and name of the first audio event, [STEREO]: Stereo Pair on/off status, and KBD: the bank/number/name of the program that will sound when you play the keyboard.

RPPR (Assign) will not show all of the RPPR assignments if there are many of them. You can use the P5- Pattern Edit page to see all of the RPPR assignments.

#### Track Number

This indicates the MIDI track number. The various parameters below each track number make settings for the corresponding track.

**Track Category** [00...17]

This shows the abbreviated category name of the Program assigned to the Track.

#### Track 01 (Track Number)

**Auto Load Prog EQ** [Off, On]

When you first load a Program into a Track, this parameter determines whether or not the Program's EQ settings will be loaded as well.

Once the Program has been loaded, you can change any or all of the EQ settings as desired. All such edits are stored in the Combination, without affecting the original Program.

Regardless of this setting, subsequent edits to the Program's EQ in Program mode will not affect the Combination.

**On:** the Program's EQ settings will be loaded automatically along with the Program. This is the default setting.

**Off:** the Program's EQ settings won't be loaded. Use this if you've set up the EQ in a specific way, and then want it to stay unchanged while you try out different Programs.

### **Bypass** [Off, On]

If this is **On (checked)**, all of the EQ will be disabled, including "Input Trim." Bypass can be convenient for comparing the results of the EQ with the original signal.

### **Input Trim** [00...99]

This controls the volume level going into the EQ. Note that this parameter uses a linear scale; 50 is equivalent to -6dB, 25 is the same as -12dB, and so on.

High settings of the Low, Mid, and High Gain controls can cause substantial increases in the overall level. You can compensate for this by turning down the input trim.

### **High Gain** [-18.0...+18.0dB]

This controls the gain of the 10kHz High Shelf EQ, in increments of 0.5dB.

### **Mid Frequency** [100Hz...10.00kHz]

This sets the center frequency for the Mid sweep EQ.

### **Mid Gain** [-18.0...+18.0dB]

This controls the gain of the Mid Sweep EQ, in increments of 0.5dB.

### **Low Gain** [-18.0...+18.0dB]

This controls the gain of the 80Hz Low Shelf EQ, in increments of 0.5dB.

## **MIDI Track EQ and the control surface**

You can use the Control Surface to adjust almost all of the Track EQ parameters (except for **Bypass**). To do so:

1. Press the **CONTROL ASSIGN MIXER TIMBRE/TRACK** switch to select either Tracks 1–8 or 9–16.
2. Use the **MIX SELECT 1/9–8/16** switches to select the Track you want to control.
3. Press the **MIXER KNOBS** switch to select **CHANNEL STRIP**.
4. Use the **MIX CHANNEL STRIP** knobs 2-6 to adjust the **EQ TRIM**, **LOW EQ gain**, **MID EQ frequency and gain**, and **HIGH EQ gain**, as desired.

### **Track 02...16 (Track Number)**

These parameters adjust the three-band EQ (with sweepable mid range) for MIDI tracks 2 through 16. They are the same as for track 1. See "Track 01":.

## ▼ 1–1: Page Menu Commands

The number before each command shows its ENTER + number-key shortcut. For more information on these shortcuts, see "ENTER + 0-9: shortcuts for menu commands" on page 147.

- 0: **Memory Status.** For more information, see "Memory Status" on page 624.
- 1: **Exclusive Solo.** For more information, see "Exclusive Solo" on page 147.
- 2: **Rename Song.** For more information, see "Rename Song" on page 624.
- 3: **Initialize Song.** For more information, see "Initialize Song" on page 624.
- 4: **Copy From Song.** For more information, see "Copy From Song" on page 624.
- 5: **Load Template Song.** For more information, see "Load Template Song" on page 624.
- 6: **Save Template Song.** For more information, see "Save Template Song" on page 625.
- 7: **FF/REW Speed.** For more information, see "FF/REW Speed" on page 625.
- 8: **Set Location** (for Locate Key.) For more information, see "Set Location (for Locate Key)" on page 626.
- 9: **GM Initialize.** For more information, see "GM Initialize" on page 626.
- 10: **Copy From Combination.** For more information, see "Copy from Combination" on page 626.
- 11: **Copy From Program.** For more information, see "Copy From Program" on page 626.
- 12: **Show EQ Graphic.** For more information, see "Show EQ Graphic" on page 503.

## 1-2: Audio Track EQ

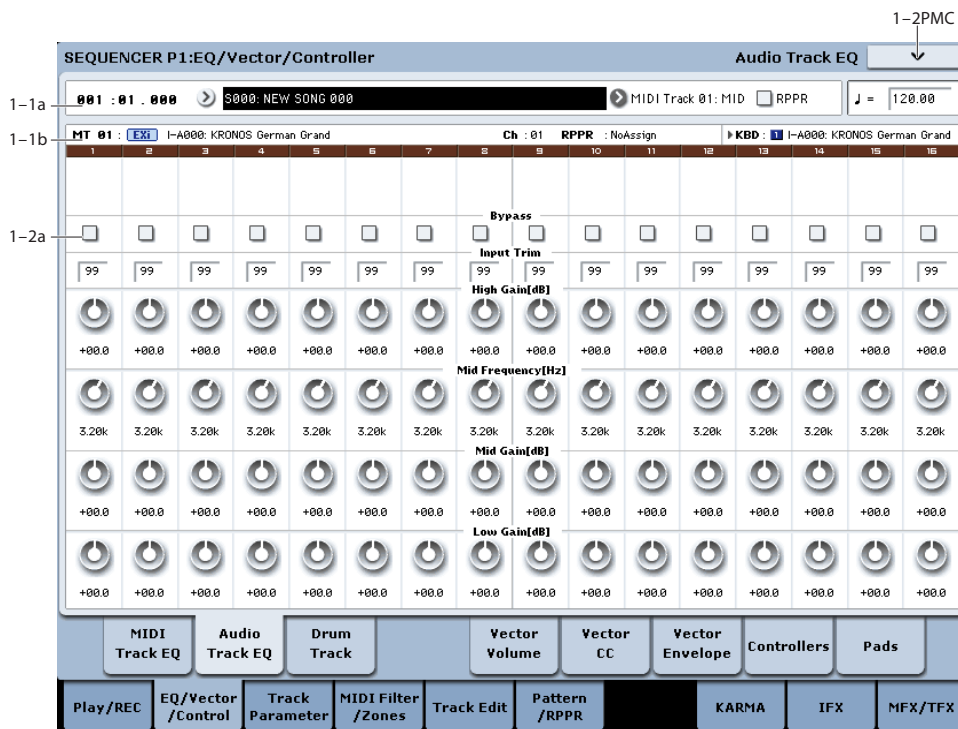

Here you can adjust the three-band EQ (with sweepable mid range) for audio track.

### 1-2a: 3 Band Parametric EQ

#### Track 01...16 (Track Number)

#### STEREO

This is shown if Stereo Pair is on.

<b>Bypass</b>	[Off, On]
<b>Input Trim</b>	[00...99]
<b>High Gain</b>	[-18.0...+18.0dB]
<b>Mid Frequency</b>	[100Hz...10.00kHz]
<b>Mid Gain</b>	[-18.0...+18.0dB]
<b>Low Gain</b>	[-18.0...+18.0dB]

Here you can adjust the mid-sweepable three-band EQ for audio tracks 1-16. For more information, please see "1-1b: 3 Band Parametric EQ" on page 546.

#### Recording the Audio Track EQ

The "Bypass," "Input Trim," "High Gain," "Mid Frequency," "Mid Gain," and "Low Gain" settings you make here are used when you play back or record from the beginning of the song. If settings other than "Bypass" are modified during recording, the changes are recorded to each audio track as automation event data, and these changes will be reproduced during playback.

You can also modify the settings during playback. However if you've recorded EQ data, the settings will change according to the recorded data.

#### Audio Track EQ and the control surface

EQ parameters other than "Bypass" can be edited not only from within the screen, but also using the control surface. You can also make this setting from the front panel mixer section or from the P0- Control Surface page of the LCD. The procedure given below describes how to make these settings from the front panel.

1. Press the CONTROL ASSIGN MIXER AUDIO switch to select either 1-8 or 9-16.
2. Press the MIXER KNOBS switch to select CHANNEL STRIP.
3. Use the MIX SELECT 1/9-8/16 switches to select the track you want to control.
4. Use the MIX CHANNEL STRIP 2-6 knobs to adjust "EQ TRIM," "LOW GAIN," "MID FREQ," "MID GAIN," and "HIGH EQ."

⚠ For tracks that you've specified as a stereo pair, the EQ of the odd-numbered track will control both tracks. Editing the EQ of the even-numbered track will not control the sound.

#### ▼ 1-2: Page Menu Commands

The number before each command shows its ENTER + number-key shortcut. For more information on these shortcuts, see "ENTER + 0-9: shortcuts for menu commands" on page 147.

- 0: **Memory Status**. For more information, see "Memory Status" on page 624.
- 1: **Exclusive Solo**. For more information, see "Exclusive Solo" on page 147.
- 2: **Rename Song**. For more information, see "Rename Song" on page 624.

- 3: **Initialize Song.** For more information, see “Initialize Song” on page 624.
- 4: **Copy From Song.** For more information, see “Copy From Song” on page 624.
- 5: **Load Template Song.** For more information, see “Load Template Song” on page 624.
- 6: **Save Template Song.** For more information, see “Save Template Song” on page 625.
- 7: **FF/REW Speed.** For more information, see “FF/REW Speed” on page 625
- 8: **Set Location** (for Locate Key.) For more information, see “Set Location (for Locate Key)” on page 626.
- 9: **GM Initialize.** For more information, see “GM Initialize” on page 626.
- 10: **Copy From Combination.** For more information, see “Copy from Combination” on page 626.
- 11: **Copy From Program.** For more information, see “Copy From Program” on page 626.
- 12: **Show EQ Graphic.** For more information, see “Show EQ Graphic” on page 503.
- 13: **Stereo Pair.** For more information, see “Stereo Pair” on page 628.

## 1–3: Drum Track

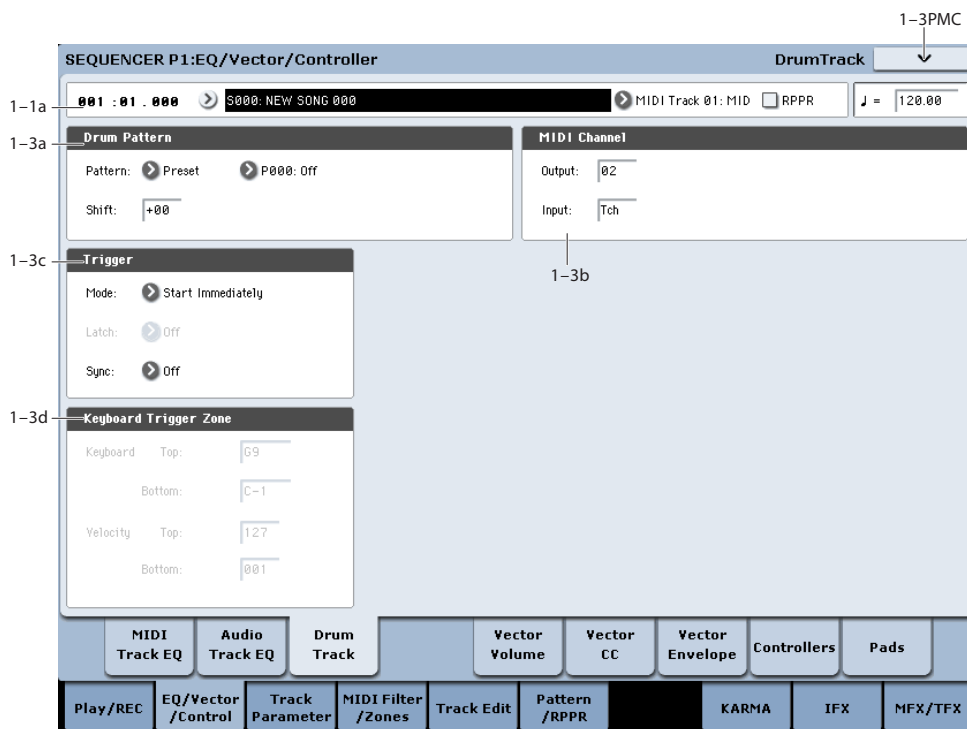

This page lets you set up the Drum Track, including the Pattern, MIDI Channel, and trigger settings.

For more details, please see “Drum Track settings in Sequencer mode” on page 242 of the Operation Guide.

### 1–3a: Drum Pattern

**Bank** [Preset, User]

This selects between Preset and User Patterns.

The Patterns in the Preset bank are from the factory, and can’t be changed.

The User bank Patterns are editable; you can load them from disk, or create new ones in Sequencer mode.

**Pattern** [(Preset): P000...P697, (User): U000...U999]

This chooses the Pattern from the selected Bank.

**Shift** [-24...+24]

**Shift** lets you transpose the Drum Track pattern in semitone steps, causing different instruments of the drum kit to play. This will generally cause unexpected results, which may often be interesting—experiment and see!

### 1–3b: MIDI Channel

**Output** [01...16, Gch]

Unlike Program mode, Sequencer mode does not have a dedicated track for the Drum Track. Instead, you can assign it to any of the 16 Tracks.

To do so, select a drum Program for the desired Timbre. Then, set the **Output** to match the Timbre’s MIDI channel.

If the Timbre’s **Status** is EXT or EX2, the Drum Track pattern will be transmitted via MIDI out

### **Input** [01...16, Tch]

This sets the MIDI channel which will trigger the Drum Track Pattern.

**Tch** is the currently selected Keyboard Track.

---

### **1-3c: Trigger**

#### **Mode** [Start Immediately, Wait KBD Trig]

#### **Latch** [On, Off]

#### **Sync** [On, Off]

These control the way in which the Drum Pattern starts and stops. They work just like the similar parameters in Program mode. For details, please see "1-3c: Trigger" on page 43.

---

### **1-3d: Keyboard Trigger Zone**

#### **Keyboard Top** [C-1...G9]

#### **Bottom** [C-1...G9]

#### **Velocity Top** [1...127]

#### **Bottom** [1...127]

These settings specify the range of keys and velocities that will trigger the Drum Track pattern when you play the keyboard (or the system receives a note-on via MIDI). They work just like the similar parameters in Program mode. For details, please see "1-3d: Keyboard Trigger Zone" on page 43.

---

### **▼ 1-3: Page Menu Commands**

The number before each command shows its ENTER + number-key shortcut. For more information on these shortcuts, see "ENTER + 0-9: shortcuts for menu commands" on page 147.

- 0: **Memory Status**. For more information, see "Memory Status" on page 624.
- 1: **Exclusive Solo**. For more information, see "Exclusive Solo" on page 147.
- 2: **Rename Song**. For more information, see "Rename Song" on page 624.
- 3: **Initialize Song**. For more information, see "Initialize Song" on page 624.
- 4: **Copy From Song**. For more information, see "Copy From Song" on page 624.
- 5: **Load Template Song**. For more information, see "Load Template Song" on page 624.
- 6: **Save Template Song**. For more information, see "Save Template Song" on page 625.
- 7: **FF/REW Speed**. For more information, see "FF/REW Speed" on page 625.
- 8: **Set Location** (for Locate Key.) For more information, see "Set Location (for Locate Key)" on page 626.
- 9: **GM Initialize**. For more information, see "GM Initialize" on page 626.
- 10: **Copy From Combination**. For more information, see "Copy from Combination" on page 626.
- 11: **Copy From Program**. For more information, see "Copy From Program" on page 626.
- 12: **Copy Drum Track**. For more information, see "Copy Drum Track" on page 506.
- 13: **Erase Drum Track Pattern**. For more information, see "Erase Drum Track Pattern" on page 635.



## 1–5: Vector Volume Control

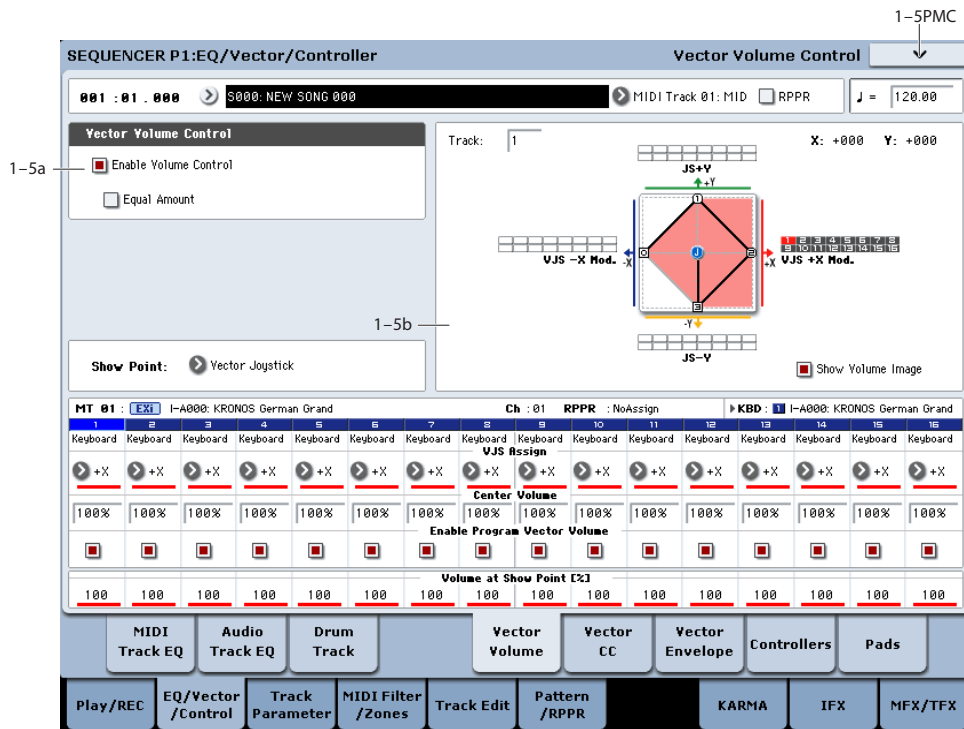

Vector Synthesis lets you control Track volumes and Program & Effects parameters by moving the Vector Joystick, by using the programmable Vector Envelope, or by the combination of the two.

For more background information on Vector Synthesis, please see “What does Vector mean?” on page 46, and “Vector Joystick and Vector Envelope” on page 46.

### Program and Song Vectors work together

In Sequencer mode, each Track’s Program still has its own Vector EG, which controls volume and CCs as it did in Program mode. You can disable the Program Vector Volume and CC control separately for each Track, if desired.

There is also a separate Song-wide Vector EG, with its own Vector Volume and CC control settings. As with the Program Vector, you can disable the Song Volume and CC control separately for each Track. Note that the Song Vector CCs affect only Tracks and Effects on the Global MIDI Channel.

### How Sequencer mode Vector Volume works

In Program mode, Vector Volume fades between the two Oscillators. Oscillator 1 is always at maximum volume when the Vector position is all the way to the left (–X), and Oscillator 2 is always at maximum when the Vector Position is all the way to the right (+X).

In Sequencer mode, on the other hand, the Vector can fade between any or all of the 16 Tracks. You can assign each of the Tracks to be controlled by any of the four Vector axes (+X, –X, +Y, –Y), or to not be controlled at all.

This lets you set up complex transitions between different Programs, including between HD-1 and different EXi instruments.

Vector Synthesis system, Sequencer mode

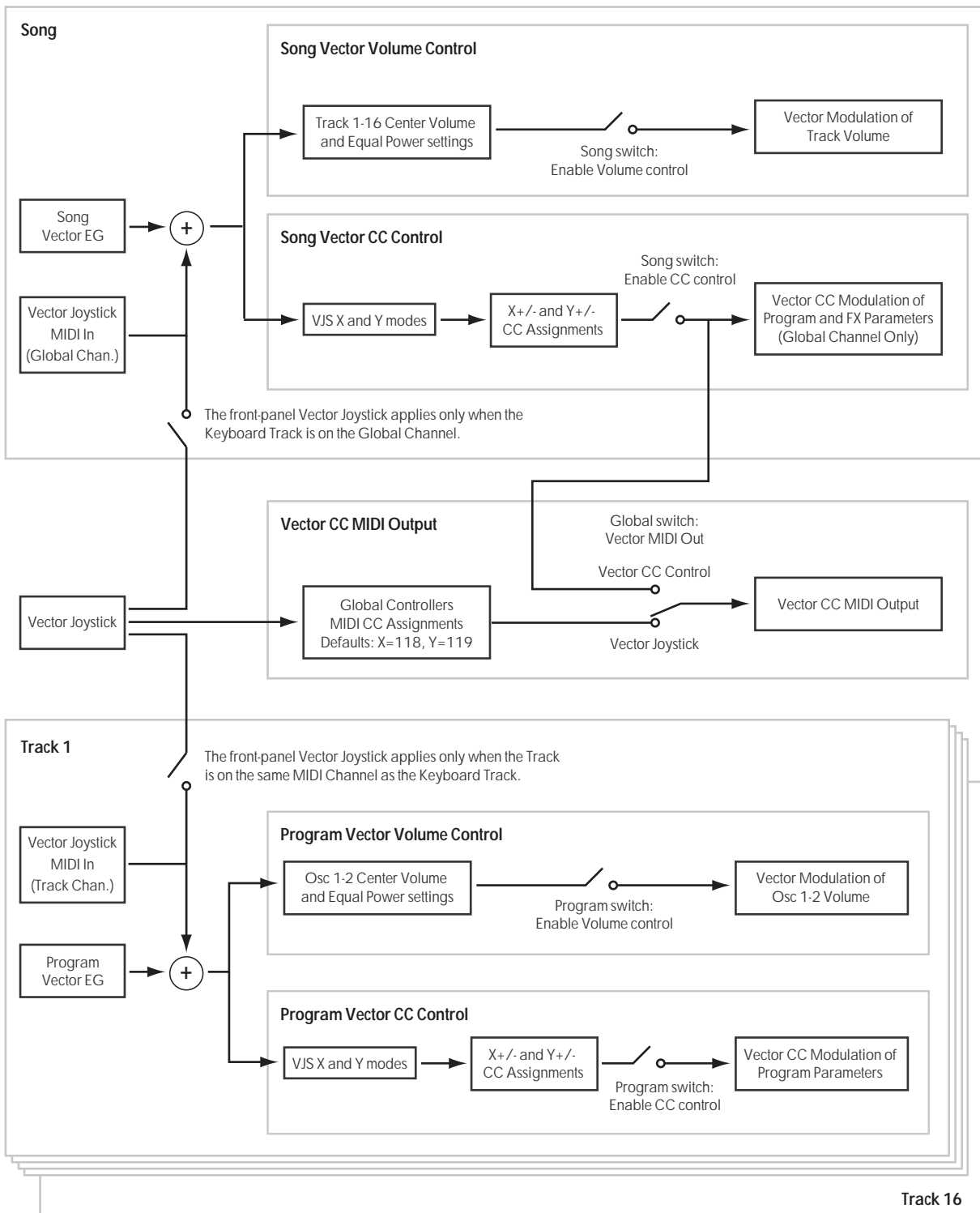

**1-5a: Vector Volume Control**

Vector Volume Control lets you adjust the relative volumes of the 16 Tracks by moving the Vector Joystick (or the Vector Envelope) from left to right on the X axis, and up and down on the Y axis.

The **Equal Amount** check-box makes the Vector create a smooth fade between the Tracks, while the individual Track **Center Volume** parameters allow you to create more complex fade shapes.

**Enable Volume Control**

**[Off, On]**

When this box is checked, the Vector position will control the volumes of all Tracks whose **VJS Assign** parameter is not set to **Off**.

When this box is not checked, the Vector position will not directly affect volume. However, it's still possible for the Vector to control volume via Vector CCs and AMS, depending on the individual Program's parameter settings.

**Equal Amount** [Off, On]

This applies only when **Enable Volume Control** is **On**.

When **Equal Amount** is **On**, the Vector will fade between all four Vector axes while maintaining a total amount of 100%. This provides a smooth fade between the different sounds, and is the type of volume control used by classic vector synths.

Note that this will work best when the Programs assigned to each of the four axes have equivalent volumes. For instance, you might create a Song with four Programs, each sounding at the same volume and assigned to a different axis. You could then add a fifth Program, assign it to one of the axes, and then reduce the volumes of both Programs on that axis by 50%—so that their combined volume is the same as any one of the other Programs.

Also, when this is checked, the **Center Volume** parameters will be grayed out, since **Equal Amount** sets them automatically.

When **Equal Amount** is **Off**, the individual Track **Center Volume** parameters determine the way in which Vector position affects volume.

*Note:* For an interesting variation on this effect, turn **Equal Amount Off**, and instead set all of the Track **Center Volumes** to 50%. The Tracks will still fade together smoothly, but with a more gentle effect towards the extremes of the Vector axes.

**1–5b: Vector Graphic**

**Vector Graphic**

This shows a diagram of the vector space, including the five points of the Vector EG (labeled 0–4) and the current position of the Vector Joystick (labeled J).

The transitions between the EG’s points are shown by black lines, and the loop transition is shown by a gray line.

**Show Volume Image** [Off, On]

The vector graphic includes an image representing the Vector Volume Control settings for the current Track (see **Track Select**, below). You can use the **Show Volume Image** check-box to toggle this part of the graphic on and off.

**Track Select** [01...16]

This selects the Track whose volume image will be shown.

**Show Point** [VJS, Vector EG Point 0...4]

You can view the volume and CC values for the current position of the Vector Joystick, or for any of the EG’s five points. This selects the point whose values will be shown.

**Track Volume & CC Display**

This read-only display shows the volume and CC values for the current Vector point, as selected by the **Show Point** parameter, above.

**Track 01**

**VJS Assign** [Off, +X, -X, +Y, -Y]

This assigns an axis of the Vector to control the Track’s volume. See the diagram “VJS Assign and Program Volume,” below, for more details.

**Off** means that the Vector position will not affect the Track’s volume.

*VJS Assign and Program Volume*

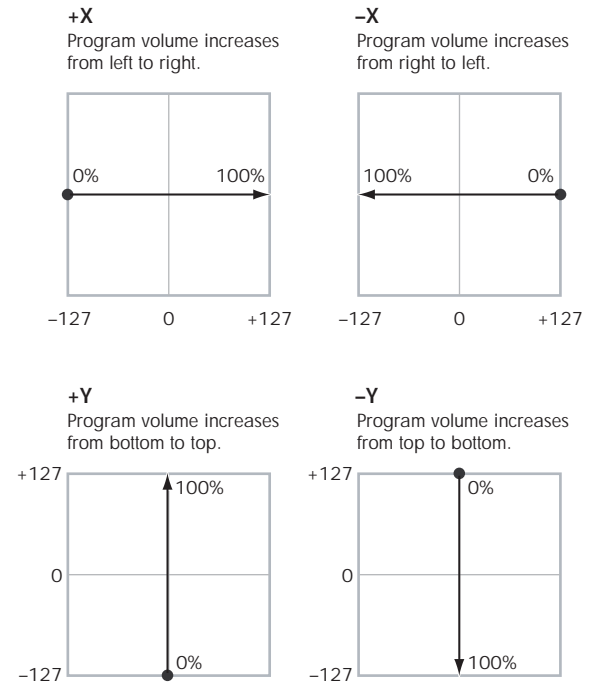

**Center Volume** [0, 25, 50, 75, 100%]

This sets the volume of Track 1 at the center point. It applies only when **Equal Amount**, above, is set to **Off**.

The volumes at the extreme ends of the axis are fixed, depending on the setting of the **VJS Assign** parameter.

For instance, if **VJS Assign** is set to **-X**, the Track will always be at 100% volume on the left side, and 0% (silent) on the right side.

This parameter applies only to the Song Vector Volume control, and does not change the Program’s individual Vector Volume settings.

*Track Center Volume, VJS Assign = -X*

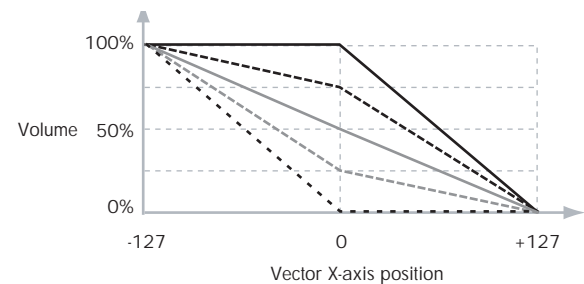

- Center Volume Values: ——— 100
- - - - - 75
- 50
- - - - - 25
- · · · · 0

**Enable Program Vector Volume [Off, On]**

When this is turned **On**, the Program’s Vector Volume control will function as it does in Program mode, crossfading between Oscillators 1 and 2. The crossfade will be controlled by the combination of the Program’s Vector EG and the Vector Joystick, and is not affected by the Song’s Vector EG.

When this is turned **Off**, the Program’s Vector Volume control will be disabled.

**Tracks 02–16**

The parameters for Tracks 2–16 are identical to those for Track 01, as described above.

**▼ 1–5: Page Menu Commands**

The number before each command shows its ENTER + number-key shortcut. For more information on these shortcuts, see “ENTER + 0-9: shortcuts for menu commands” on page 147.

- 0: **Memory Status**. For more information, see “Memory Status” on page 624.
- 1: **Exclusive Solo**. For more information, see “Exclusive Solo” on page 147.

- 2: **Rename Song**. For more information, see “Rename Song” on page 624.
- 3: **Initialize Song**. For more information, see “Initialize Song” on page 624.
- 4: **Copy From Song**. For more information, see “Copy From Song” on page 624.
- 5: **Load Template Song**. For more information, see “Load Template Song” on page 624.
- 6: **Save Template Song**. For more information, see “Save Template Song” on page 625.
- 7: **FF/REW Speed**. For more information, see “FF/REW Speed” on page 625.
- 8: **Set Location** (for Locate Key.) For more information, see “Set Location (for Locate Key)” on page 626.
- 9: **GM Initialize**. For more information, see “GM Initialize” on page 626.
- 10: **Copy From Combination**. For more information, see “Copy from Combination” on page 626.
- 11: **Copy From Program**. For more information, see “Copy From Program” on page 626.

**1–6: Vector CC Control**

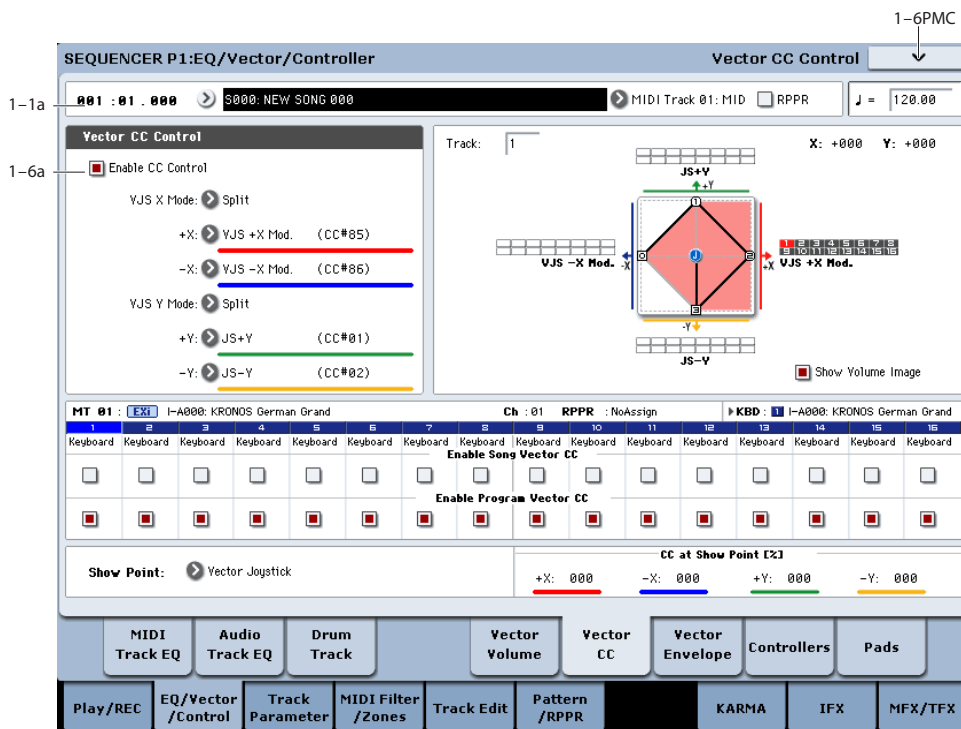

**1–6a: Vector CC Control**

Vector CC Control lets you use the combination of the Vector Joystick and the Vector EG to control the Song’s Effects.

Each of the four directions of the Vector can send a different MIDI CC, including left (–X), right (+X), up (+Y), and down (–Y). You can choose between several different patterns combining these four directions by using the VJS X Mode and VJS Y Mode parameters.

The Vector CCs are also sent to all Global Channel Tracks. These may modulate Program parameters, like any other MIDI CCs, depending on the settings within each individual Program.

Finally, you can optionally send these CCs out to external MIDI instruments. A global parameter allows you to enable or disable this MIDI output; by default, it is disabled.

### Program and Song Vectors work together

In Sequencer mode, each Track’s Program still has its own Vector EG, which controls volume and CCs as it did in Program mode. You can disable the Program’s Vector Volume and CC control separately for each Track, if desired.

Program Vector CCs affect only their own Program, even if other Tracks are set to the same MIDI channel.

There is also a single, separate Vector EG for the entire Song, with its own Vector Volume and CC control settings. Song Vector CCs affect all Tracks set to the Global channel. As with the Program Vector, you can disable the Song Volume and CC control separately for each Track.

### Vector and MIDI

The Vector features interact with MIDI in two different ways: through the Vector Joystick, and through the Vector CC Control.

The **Vector Joystick** sends and receives two MIDI controllers: one for the X axis, and the other for the Y axis. In Global mode, you can assign these to any MIDI CC numbers you like. The defaults are CC#118 for the X axis, and CC#119 for the Y axis.

The Vector Joystick and its CCs *control* the Vector position, in conjunction with the Vector EG.

The **Vector CC Control**, on the other hand, is *generated by* the Vector position. Normally, this will only affect internal sounds and effects. If you like, however, you can also enable a Global parameter to send these generated CCs to external MIDI devices.

Note that, in Sequencer mode, only the Song’s Vector CCs can be sent to external MIDI instruments; the individual Program’s vector CCs are only used internally.

### Enable CC Control [Off, On]

When this box is checked, the Vector position will send the CCs assigned to +X, –X, +Y, and –Y, as set below. Note that the Song Vector CCs affect only Tracks and Effects on the Global MIDI Channel.

When this box is not checked, the Vector position will not affect these CCs. However, the joystick will still send and receive its dedicated MIDI CCs, just like other physical controllers. See “Vector and MIDI,” above, for more information.

This parameter affects only the Song Vector CCs. Even if this is turned **Off**, the individual Programs’ Vector CCs will still function normally.

### VJS X Mode [Positive, Negative, Xfade, Split]

You can set up the Vector to send out CCs in several different patterns, as shown in the graphic below. This controls the pattern for the X axis.

Note that this setting affects only CC Control; it has no effect on Volume Control. Also, it applies only to the Song’s Vector CCs, and has no effect on the individual Program Vector CCs.

**Positive** sends out only +X, starting at 0 at the far left, and increasing to 127 at the far right. –X is disabled in this mode.

**Negative** sends out only –X, starting at 0 at the far right, and increasing to 127 at the far left. In this mode, +X is grayed out.

**Xfade** sends out both +X and –X, overlapping throughout the X axis. As one increases, the other decreases.

**Split** sends out both +X and –X, with a split in the center. +X is sent when the point moves to the right of the center, and –X is sent when the point moves to the left of center.

### +X [Off...MIDI CC#119]

This assigns the controller sent by the +X vector. You can use this as an AMS source to control Program parameters, or as a Dmod source to control Effects parameters. It will be grayed out if the VJS X Mode, above, is set to Negative.

In addition to the standard list of MIDI controllers, you can also assign the +X vector to duplicate the function of several front-panel controllers, including JS X, JS+X, JS-X, Knobs 5–8, and SW 1–2.

For instance, if you assign +X to Knob 6, the vector’s +X will use the controller assigned to Knob 6 on the Controller Assign page.

Finally, you can also assign +X to control the Master Volume.

### –X [Off...MIDI CC#119]

This assigns the controller sent by the –X vector. It will be grayed out if the VJS X Mode, above, is set to Positive.

The selections are the same as for +X, above.

### VJS Y Mode [Positive, Negative, Xfade, Split]

This controls the Vector CC pattern for the Y axis. For more information, see the description under VJS X Mode, above.

### +Y [Off...MIDI CC#119]

This assigns the controller sent by the +Y vector. It will be grayed out if the VJS Y Mode, above, is set to Negative.

The selections are the same as for +X, above.

### –Y [Off...MIDI CC#119]

This assigns the controller sent by the –Y vector. It will be grayed out if the VJS Y Mode, above, is set to Positive.

The selections are the same as for +X, above.

### Vector CC Modes

#### Positive

Generates only +X, increasing from left to right.

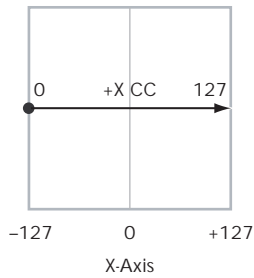

#### Negative

Generates only -X, increasing from right to left.

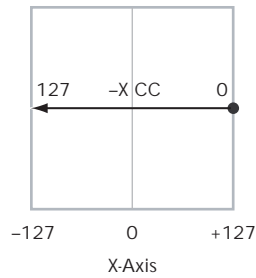

#### Xfade

Generates both +X and -X. One increases as the other decreases.

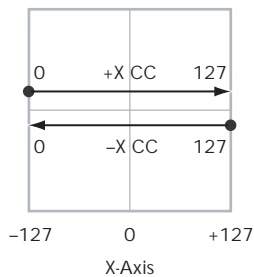

#### Split

Generates both +X and -X. Both are 0 in the center. +X increases to the right; -X increases to the left.

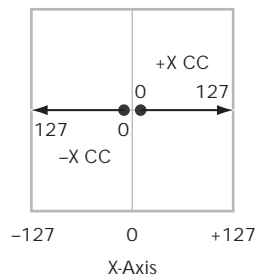

### Show Point [VJS, Vector EG Point 0...4]

You can view the volume and CC values for the current position of the Vector Joystick, or for any of the EG's five points. This selects the point whose values will be shown.

#### CC at Show Point [%]

This read-only display shows the volume values for the current Vector point, as selected by the Show Point parameter, above.

### Track 01

#### Enable Song Vector CC [Off, On]

This controls whether or not the Track will receive the Song's Vector CCs.

If this is **On**, the Track will receive the CCs, and the Track's Program will respond to them according to its own AMS settings.

If this is **Off**, the Track will not receive the CCs. This can be useful if the Song's Vector CCs are causing unwanted modulation, or conflicting with the Program's own Vector CCs.

#### Enable Program Vector CC [Off, On]

This controls whether or not the Program's own Vector CCs will be active.

If this is **On**, the Program's Vector CCs and Vector EG will work as AMS sources, just as they did in Program mode. The CCs will not affect any other Tracks, even if they are set to the same MIDI channel.

Note that, in some cases, the Vector CCs may have been used for modulating the Program's effects via Dmod. This functionality is not carried into the Song; for modulating the Song's effects, use the Song's Vector CCs instead.

If Enable Program Vector CC is **Off**, then the Program's Vector CCs will have no effect. This can be useful if they are conflicting with the Song's Vector CCs.

### Tracks 02–16

The settings for Tracks 2–16 are identical to those for Track 01, as described above.

## ▼ 1–6: Page Menu Commands

The number before each command shows its ENTER + number-key shortcut. For more information on these shortcuts, see "ENTER + 0-9: shortcuts for menu commands" on page 147.

- 0: **Memory Status**. For more information, see "Memory Status" on page 624.
- 1: **Exclusive Solo**. For more information, see "Exclusive Solo" on page 147.
- 2: **Rename Song**. For more information, see "Rename Song" on page 624.
- 3: **Initialize Song**. For more information, see "Initialize Song" on page 624.
- 4: **Copy From Song**. For more information, see "Copy From Song" on page 624.
- 5: **Load Template Song**. For more information, see "Load Template Song" on page 624.
- 6: **Save Template Song**. For more information, see "Save Template Song" on page 625.
- 7: **FF/REW Speed**. For more information, see "FF/REW Speed" on page 625.
- 8: **Set Location** (for Locate Key.) For more information, see "Set Location (for Locate Key)" on page 626.
- 9: **GM Initialize**. For more information, see "GM Initialize" on page 626.
- 10: **Copy From Combination**. For more information, see "Copy from Combination" on page 626.
- 11: **Copy From Program**. For more information, see "Copy From Program" on page 626.

## 1-7: Vector Envelope

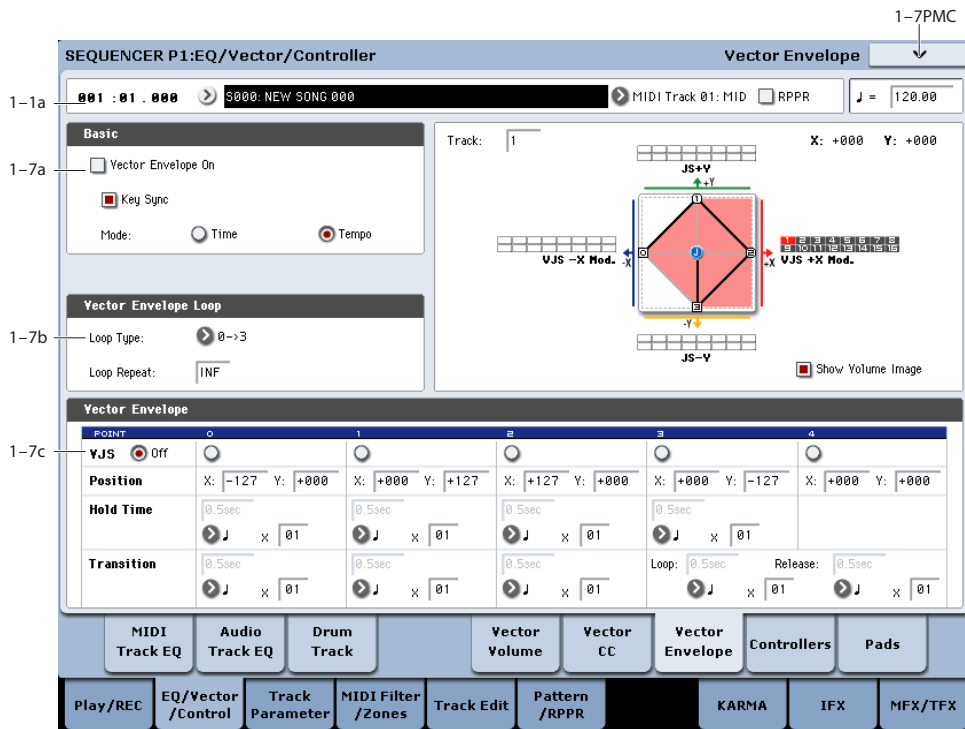

The Vector Envelope works together with the Vector Joystick to control the Vector position. It's particularly convenient for modulating effects, since it's the only programmable modulation source stored with the Song, outside of KARMA.

The Vector Envelope is different from the other envelopes in several ways:

- Each point has two “levels” - one for the X axis, and one for the Y axis.
- The envelope times can be based on seconds and milliseconds, or synced to tempo.
- Each point has a hold time, as well as a transition time to the next point.
- The envelope can loop between two points, for either a specified number of repeats, or as long as you hold the note.

### Vector Volume and CC control use separate EGs

There are actually two different Vector EGs, which share the same parameters: one for Volume Control, and the other for CC Control.

All of the notes on the Song’s Global Channel share a single CC Control EG. This EG starts when you first play a note, and continues as long as any notes are held down on the keyboard. When you release all of the notes, the EG goes into its release phase.

Each note then has its own, additional Volume Control EG, which lets you crossfade between Programs to create complex, evolving timbres. The **Key Sync** parameter applies only to this per-note EG.

When the **Key Sync** parameter is **Off**, the CC Control and Volume Control EGs are completely synchronized.

When **Key Sync** is **On**, each note’s Volume Control EG will start at note-on, and go into release at note-off. All the notes will still share a single CC Control EG.

### 1-7a: Basic

#### Vector Envelope On [Off, On]

**On (checked):** When this box is checked, the Vector EG will work with the Vector Joystick to control the vector position.

**Off (unchecked):** When this box is not checked, the Vector EG will not run. The vector position will be controlled solely by the Vector Joystick.

#### Key Sync [Off, On]

The Key Sync parameter applies only to Vector Volume control. As described under “Vector Volume and CC control use separate EGs,” above, Vector CC control always acts as if Key Sync were Off.

**On (checked):** When Key Sync is **On**, the Vector Volume EG starts each time you press a key, and an independent EG runs for each note. This is the normal setting.

**Off (unchecked):** When Key Sync is **Off**, the Vector Volume EG starts from the phase determined by the first note in the phrase, so that the EGs for all notes being held are synchronized together.

#### Mode [Time, Tempo]

**Time:** When the Mode is set to **Time**, you can set the EG segment times in seconds or milliseconds.

**Tempo:** When the Mode is set to **Tempo**, the Vector EG will synchronize to the system tempo, as set by either the Tempo knob or MIDI Clock. Instead of using



seconds and milliseconds, you can specify the EG times as rhythmic values, using the Base Note and x (Multiply Base Note by...) parameters.

### 1-7b: Vector Envelope Loop

The Vector EG can loop between two points, and can continue to loop either for as long as you hold the note, or for a specified number of repeats. You can also turn the loop off completely, if you like.

**Loop Type** [0->3, 1->3, 2->3, 0<->3, 1<->3]

This selects the start and end points of the loop, and whether the loop is forwards only or forwards-backwards.

The first three selections, 0->3, 1->3, and 2->3, loop forwards only. For instance, when Loop Type is set to 1->3, the EG will play as follows: 0, 1, 2, 3, 1, 2, 3, 1, 2, 3 etc.

The last two selections, 0<->3 and 1<->3, are forwards-backwards. For instance, with the 1<->3 setting, the EG will play as follows: 0, 1, 2, 3, 2, 1, 2, 3 etc.

**Loop Repeat** [Off, 1...126, Inf]

**Off:** When this is set to Off, the EG will not loop at all.

**1-126:** The EG will loop the specified number of times, and then hold at point 3 until the note is released.

**Inf:** The EG will loop as long as the note is held, and then move to point 4 when the note is released.

### 1-7c: Vector Envelope

The Vector EG has a total of five points. Since the Vector EG can loop, the points are labeled differently from standard envelopes; instead of names like attack and decay, they are simply numbered 0-4.

**Sustain and Release**

When the EG is in the middle of a loop, there is no "sustain" point per se. However, if the EG has already completed the specified number of Loop Repeats, or if Loop Repeat is Off, it will sustain at Point 3 until release.

At release, the EG always moves to Point 4.

**Hold and Transition times**

The Hold Time sets how long the EG lingers at each point, and the Transition time sets how long it takes to go from the selected point to the next.

For instance, the graphic below shows the succession of Hold and Transition times when the Loop Type is set to 1->3. For clarity, only the Y axis positions are shown.

Vector EG times, Loop Type = 1->3

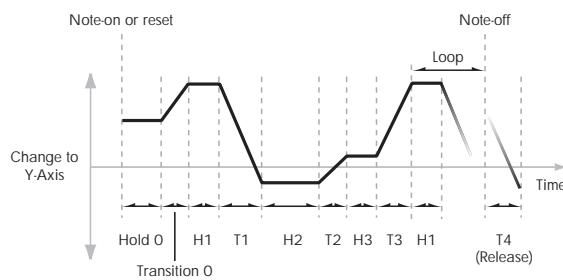

The transition from Point 3 into the loop always uses Point 3's Transition time, regardless of the Loop Type.

Points 0, 1, and 2's Transition times, however, work in reverse when moving backwards during a forwards-backwards loop. It's as if you were re-tracing the EG shape in reverse.

For instance, in the backwards section of a loop, moving from Point 2 to Point 1 uses Point 1's Transition time.

Forwards-Backwards Loop, Loop Type = 1<->3

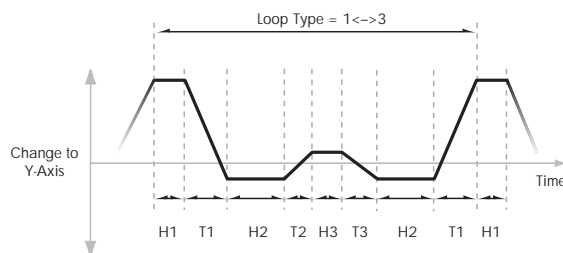

**VJS** [Off, 0...4]

This horizontal row of radio buttons lets you edit the selected point's X-Y position using the Vector Joystick.

Just press the point's radio button, move the Vector Joystick to the desired location. When you're finished, press the Off radio button again.

When you are not editing the EG's X-Y positions, you should leave this set to Off, to avoid inadvertent changes to the EG.

**Point 0**

**Position**

In addition to editing the X and Y parameters with the standard data entry controls, you can also simply use the Vector Joystick to set the position, as described under "VJS," above.

**X** [-127...+127]

This sets the point's position on the X axis.

**Y** [-127...+127]

This sets the point's position on the Y axis.

**Hold Time**

This sets the length of time that the EG will stay on Point 0, before moving to Point 1. You can set the Hold Time in either seconds/milliseconds or rhythmic values, depending on the setting of the EG's Mode parameter.

**Time** [0ms...60sec]

This parameter lets you set the Hold Time in seconds and milliseconds. It applies only when the Mode is set to Time.

**(Base Note)** [Off, ♪ ... ◡]

This menu sets a basic rhythmic value for the **Hold Time**, relative to the system tempo. The values range from a 32nd note to a whole note, including triplets.

This parameter applies only when the **Mode** is set to **Tempo**.

**x (Multiply Base Note by...)** [01...32]

This multiplies the length of the **Base Note**. For instance, if the **Base Note** is set to a sixteenth note, and the multiplier is set to 3, the **Hold Time** will last for a dotted eighth note.

**Transition**

This sets the length of time that the EG takes to move from Point 0 to Point 1.

When the Loop Type is set to 0<->3, this also sets the time that it takes to move from Point 1 to Point 0 during the backwards section of the loop.

**Time** [0ms...60sec]

This parameter lets you set the Transition time in seconds and milliseconds. It applies only when the **Mode** is set to Time.

**(Base Note)** [♪ ... ◡]

This menu sets a basic rhythmic value for the **Transition Time**, relative to the system tempo. It applies only when the **Mode** is set to **Tempo**.

**x (Multiply Base Note by...)** [01...32]

This multiplies the length of the **Base Note**. For instance, if the **Base Note** is set to a sixteenth note, and the multiplier is set to 3, the EG will move from Point 0 to Point 1 over a dotted eighth note.

**Points 1 and 2**

Points 1 and 2 work exactly like Point 0, as described above.

**Point 3**

Point 3 also works much like Points 0–2, with two main differences:

Point 3 always uses its own **Loop** time when moving into the loop, regardless of the direction of the loop.

If **Loop Repeat** is set to Off, or if the Loop is set to 1–126 and has already played the specified number of times, then the EG will stay at Point 3 until the EG either goes into release, or is reset by KARMA.

**Hold Time**

This works just like the Hold Time for Point 0, as described under “Hold Time,” above.

**Loop**

This sets the length of time that it takes to move from Point 3 to the first Point in the loop. You can set this in either seconds/milliseconds or rhythmic values, depending on whether the **Mode** is set to Time or Tempo.

The **Time**, **Base Note**, and **Multiplier** parameters work just like those for Point 0, as described under “Transition,” above.

**Point 4**

Point 4 is the Vector EG’s release destination. Its time setting is different from those of the other Points. Instead of setting the time it takes to move from Point 4 to the next Point, it sets how long it takes to go from the previous Point to Point 4.

The EG moves to Point 4 as soon as it releases, regardless of where it was before the release. For instance, let’s say that the EG is in the middle of Point 2’s Hold Time at note-off. The EG will immediately begin to move to Point 4, without waiting for the Hold Time to complete.

**Release**

This sets the length of time that it takes to move to Point 4 after note-off. You can set this in either seconds/milliseconds or rhythmic values, depending on whether the **Mode** is set to Time or Tempo.

The **Time**, **Base Note**, and **Multiplier** parameters work just like those for Point 0, as described under “Transition,” above.

**KARMA and Vector EG interaction**

KARMA can start and re-start the Vector EG in various ways, as described below.

**CC Control EG**

When KARMA is **On**, it always starts and re-starts the CC Control EG, according to the KARMA trigger settings. This lets KARMA control sounds or effects in synchronization with the KARMA GE.

**Volume Control EGs**

When **Key Sync** is **Off**, and KARMA is **On**, KARMA will start and re-start the Volume Control EGs as well as the CC Control EG. This means that the resulting changes in oscillator volumes will be synchronized with the KARMA GE.

When **Key Sync** is **On**, KARMA does not affect Vector Volume Control. Each note will have its own, independent Volume Control EG, just as if KARMA was turned off.

**Entering the EG’s release stage**

Assuming that KARMA is **On**:

When the **KARMA LATCH** switch is **Off**, the KARMA-controlled Vector EG(s) will start to release when you remove your hand from the keyboard (and when KARMA is no longer receiving any input notes from other sources).

When the **KARMA LATCH** switch is **On**, the KARMA-controlled Vector EG(s) will start to release only when **KARMA Latch** is turned **Off** again.

### ▼ 1-7: Page Menu Commands

The number before each command shows its ENTER + number-key shortcut. For more information on these shortcuts, see “ENTER + 0-9: shortcuts for menu commands” on page 147.

- 0: **Memory Status.** For more information, see “Memory Status” on page 624.
- 1: **Exclusive Solo.** For more information, see “Exclusive Solo” on page 147.
- 2: **Rename Song.** For more information, see “Rename Song” on page 624.
- 3: **Initialize Song.** For more information, see “Initialize Song” on page 624.
- 4: **Copy From Song.** For more information, see “Copy From Song” on page 624.
- 5: **Load Template Song.** For more information, see “Load Template Song” on page 624.

- 6: **Save Template Song.** For more information, see “Save Template Song” on page 625.
- 7: **FF/REW Speed.** For more information, see “FF/REW Speed” on page 625
- 8: **Set Location** (for Locate Key.) For more information, see “Set Location (for Locate Key)” on page 626.
- 9: **GM Initialize.** For more information, see “GM Initialize” on page 626.
- 10: **Copy From Combination.** For more information, see “Copy from Combination” on page 626.
- 11: **Copy From Program.** For more information, see “Copy From Program” on page 626.
- 12: **Copy Vector Envelope.** For more information, see “Copy Vector Envelope” on page 153.

## 1-8: Set Up Controllers

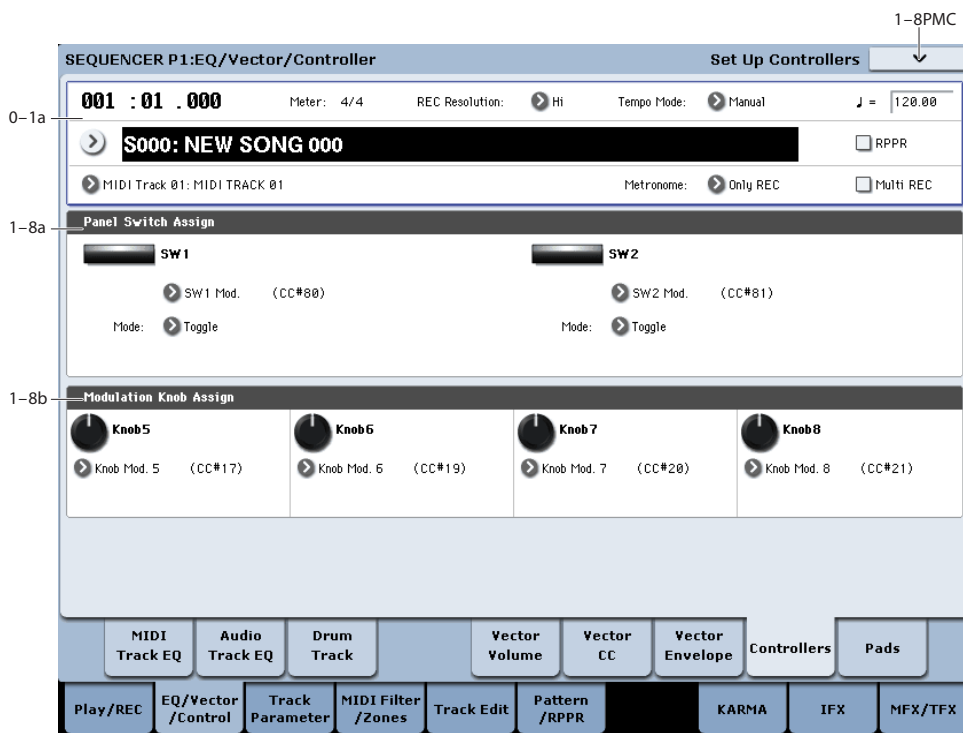

Here you can set the Sequencer functions of the SW1 switch, SW2 switch, and the Realtime Modulation Knob 5-8. These settings are made independently for each song.

When you operate these switches and knobs during recording, the MIDI messages assigned to them will be recorded.

### 1-8a: Panel Switch Assign

Here you can assign the function of the SW1 and SW2 switches. For details on the functions that can be assigned, see “SW1/2 Assignments” on page 1104.

Since the assignable panel switch functions of the program assigned to each track are ignored, you can make new settings here.

#### SW1 [Off, ..., After Touch Lock]

Assigns a function to the SW1 switch. The on/off status can also be saved. When you change the assigned function, the status will be reset to off.

#### Mode [Toggle, Momentary]

Specifies the on/off action that occurs when you press the SW1 switch.

**Toggle:** The function will alternate between on and off each time you press the SW1 switch.

**Momentary:** The function will be on only while you continue holding down the SW1 switch.

**SW2** [Off, ..., After Touch Lock]

**Mode** [Toggle, Momentary]

Assigns a function to the SW2 switch. The functions you can assign to the SW2 switch are the same as for the SW1 switch with the exception that SW1 Mod.:CC#80 is replaced by SW2 Mod.:CC#81.

---

## 1–8b: Modulation Knob Assign

Here you can assign the function of the realtime modulation knobs 5 through 8. Most of the functions that can be assigned are control changes. For more information, please see “Realtime Knobs 5–8 Assignments” on page 1105.

The functions you assign here are performed when you operate realtime modulation knobs 5 through 8.

**Knob 5** [Off, ..., MIDI CC#119]

**Knob 6** [Off, ..., MIDI CC#119]

**Knob 7** [Off, ..., MIDI CC#119]

**Knob 8** [Off, ..., MIDI CC#119]

---

## ▼ 1–8: Page Menu Commands

The number before each command shows its ENTER + number-key shortcut. For more information on these shortcuts, see “ENTER + 0-9: shortcuts for menu commands” on page 147.

- 0: **Memory Status.** For more information, see “Memory Status” on page 624.
- 1: **Exclusive Solo.** For more information, see “Exclusive Solo” on page 147.
- 2: **Rename Song.** For more information, see “Rename Song” on page 624.
- 3: **Initialize Song.** For more information, see “Initialize Song” on page 624.
- 4: **Copy From Song.** For more information, see “Copy From Song” on page 624.
- 5: **Load Template Song.** For more information, see “Load Template Song” on page 624.
- 6: **Save Template Song.** For more information, see “Save Template Song” on page 625.
- 7: **FF/REW Speed.** For more information, see “FF/REW Speed” on page 625.
- 8: **Set Location** (for Locate Key.) For more information, see “Set Location (for Locate Key)” on page 626.
- 9: **GM Initialize.** For more information, see “GM Initialize” on page 626.
- 10: **Copy From Combination.** For more information, see “Copy from Combination” on page 626.
- 11: **Copy From Program.** For more information, see “Copy From Program” on page 626.

## 1–9: Pads

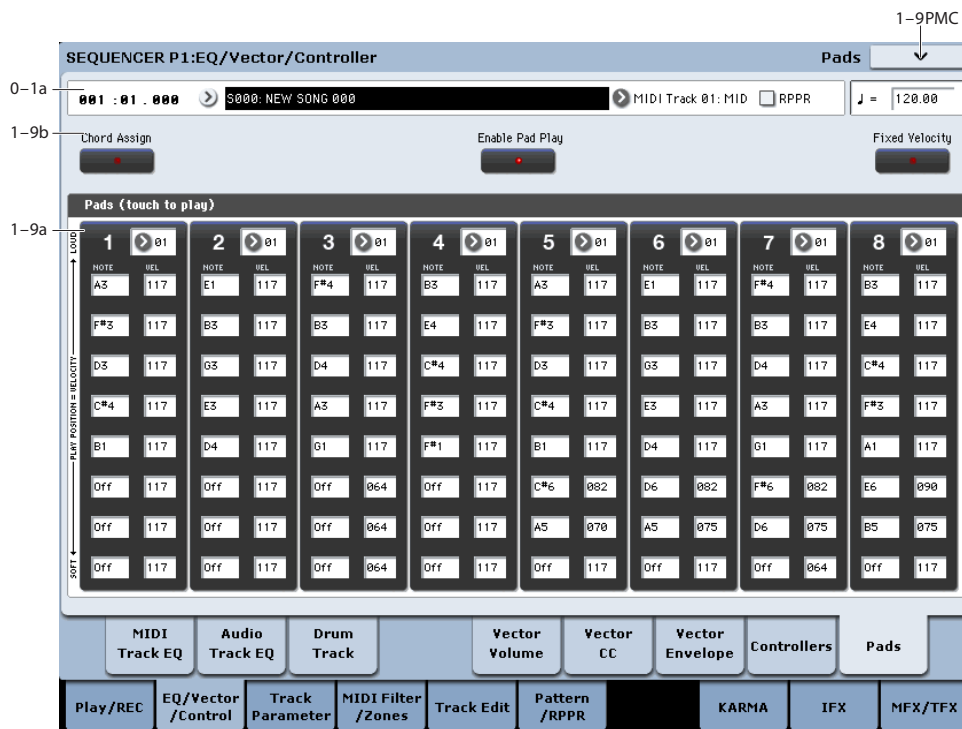

To avoid damaging the display, use care when playing the pads. Do not press strongly on the display or strike forcefully; instead, use a light and precise touch. “Velocity” is controlled by position, and not by force.

This page features 8 touch-controlled virtual “pads,” which you can use for:

- Storing and selecting chords for Chord mode
- Selecting and triggering chords, especially for use with KARMA
- Playing drum sounds, especially in conjunction with a compatible USB MIDI pad device

The pads can play up to eight-note chords—and they even remember the velocities of the individual notes within the chord. Each Pad can also be assigned to a different MIDI channel, if desired. These settings are stored independently for each Song.

You can play the pads in several different ways:

- By playing directly on the screen
- Via a pad-equipped Korg USB MIDI controller
- Via incoming MIDI notes or CCs, or the same from the local keyboard

For more information, see “Playing the pads” on page 54.

For general information on the pads, including step-by-step instructions and usage tips, see “Using the Chord Pads” on page 35 of the Operation Guide.

In addition to playing sounds directly, the pads are also used to select chords for Chord mode. For more information, see “Using Chord mode” on page 36 of the Operation Guide.

### 1–9a: Pad Chords

#### Pad 1

**MIDI Channel** [Ch01...Ch16, Tch]

This sets the pad’s MIDI output channel. You can set this to either a specific channel (1-16), or to follow the channel of the selected Track.

**Ch01...Ch16:** The pad will transmit on the selected MIDI channel. As shown in the diagram “Pads and MIDI Channel,” below, you can:

- Use this in conjunction with the Track **MIDI Channel** setting, to route a pad to a specific Track. For more information, see “MIDI Channel” on page 562.
- Use this with the KARMA Module **Input Channel** setting, to generate a phrase or other KARMA function when you play a specific pad. For more information, see “Input Channel” on page 471.

**Tch:** With this setting, the pads will follow the **MIDI channel** of the currently selected Track.

Pads and MIDI Channel

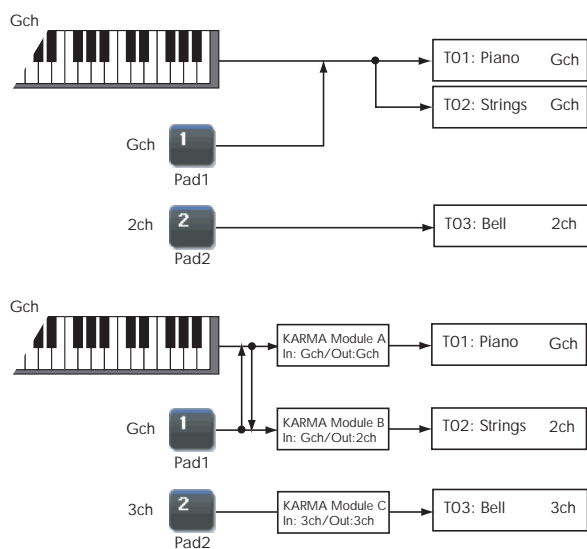

**Notes 1-8** [Off, C-1...G9 / 001...127]

These parameters let you edit the 8 notes assigned to each pad, along with a separate velocity for each note. To play fewer than 8 notes, just set the unwanted notes to **Off**.

**Off:** Select this to disable the note.

**C-1...G9:** This sets the note number.

**001...127:** This sets the note's velocity value. For more information on pads and velocity, please see "Fixed Velocity" on page 55.

You can assign notes to the pads directly from the keyboard, or enter notes and velocities manually. You can also copy all notes from one pad to another. Regardless of how the notes were first assigned, you can edit their values here.

For detailed instructions on assigning notes and copying pads, please see "Using the Chord Pads" on page 35 of the Operation Guide.

**Pad 2...8**

These are the same as for Pad 1, as described above.

**1-9b: Control buttons**

**Chord Assign** [Off, On]

**Enable Pad Play** [Off, On]

**Fixed Velocity** [Off, On]

These buttons work the same as in Program mode. For detailed information, please see "1-9b: Control buttons" on page 55.

▼ **1-9: Page Menu Commands**

The number before each command shows its ENTER + number-key shortcut. For more information on these shortcuts, see "ENTER + 0-9: shortcuts for menu commands" on page 147.

- **0: Memory Status.** For more information, see "Memory Status" on page 624.

- **1: Exclusive Solo.** For more information, see "Exclusive Solo" on page 147.
- **2: Rename Song.** For more information, see "Rename Song" on page 624.
- **3: Initialize Song.** For more information, see "Initialize Song" on page 624.
- **4: Copy From Song.** For more information, see "Copy From Song" on page 624.
- **5: Load Template Song.** For more information, see "Load Template Song" on page 624.
- **6: Save Template Song.** For more information, see "Save Template Song" on page 625.
- **7: FF/REW Speed.** For more information, see "FF/REW Speed" on page 625.
- **8: Set Location (for Locate Key.)** For more information, see "Set Location (for Locate Key)" on page 626.
- **9: GM Initialize.** For more information, see "GM Initialize" on page 626.
- **10: Copy From Combination.** For more information, see "Copy from Combination" on page 626.
- **11: Copy From Program.** For more information, see "Copy From Program" on page 626.
- **12: Copy Pad Setup.** For more information, see "Copy Pad Setup" on page 154.

# Sequencer P2: Track Parameters

## 2-1: MIDI

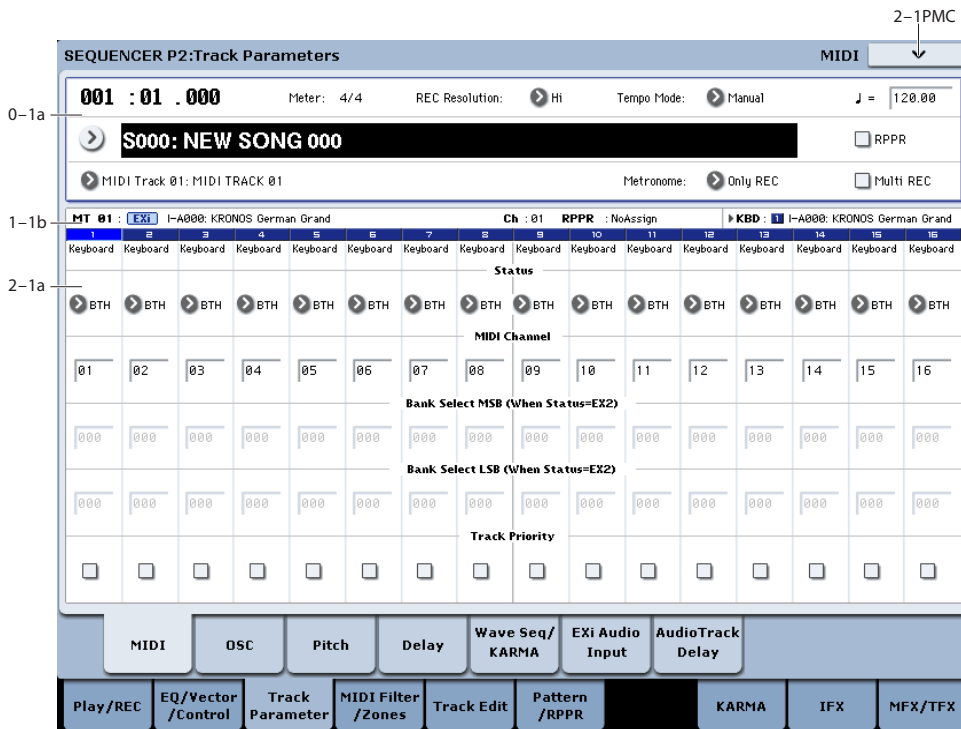

Here you can make MIDI-related settings for each MIDI track.

### 2-1a: MIDI

#### Track 01 (Track Number)

#### Status [Off, INT, BTH, EXT, EX2]

This sets whether the Track controls the internal sounds, external MIDI devices, or both.

When controlling external MIDI devices, it also allows you to choose between using the internal Bank Select numbers (as set by the front-panel buttons), or using custom Bank Select settings to match the external device.

**Off:** Use this to disable the Track. With this setting, the Track's Program will not sound, and MIDI data will not be transmitted. Also, any EXi fixed resources used by the Program will be freed.

**INT:** When the musical data recorded in the MIDI track is played back, or when you use **Track Select** (0-1a) to select a MIDI track that is set to INT and play the keyboard and operate the controllers, the internal tone generator of the KRONOS will sound, and MIDI data will not be transmitted to an external device.

**BTH:** The operation of both INT and EXT will be performed. When the musical data recorded in the MIDI track is played back, or when you select a MIDI track that is set to BTH and play the keyboard and operate the controllers, the internal tone generator of the KRONOS will sound, and at the same time MIDI data will also be transmitted to an external device.

**EXT:** When the musical data recorded in the MIDI track is played back, or when you select a MIDI track that is set to EXT and play the keyboard and operate the controllers, MIDI data will be transmitted to an external device, but the internal tone generator of the KRONOS will not sound.

When you select another song or return to the beginning of the song, the program change, volume, panpot, portamento, sends 1 and 2, post IFX pan, and post IFX sends 1 and 2 of each MIDI track set to EXT will be transmitted via MIDI.

**EX2:** This enables you to specify a particular MIDI Bank Select message for the Track, instead of automatically using the Bank of the selected KRONOS Program. Use the parameters below, labeled **Bank Select MSB and LSB (When Status =EXT2)**, to set the Bank Select message as desired. In other respects this is the same as EXT, described above.

**MIDI** MIDI data is transmitted and received on the MIDI channel that is specified separately for MIDI track by "MIDI Channel."

Status	Keyboard, Sequencer, & MIDI In play Internal Sounds	Keyboard & Sequencer Transmit MIDI Out
OFF	No	No
INT	Yes	No
EXT	No	Yes (using the Bank Select message of the track's Program)



EX2	No	Yes (using the Bank Select message specified on the MIDI tab of the Track Param page)
BTH	Yes	Yes

**MIDI Channel [01...16]**

Specifies the MIDI channel that the MIDI track will use to transmit and receive musical data. The MIDI channel you specify here will be the receive channel when **Status** is INT, the transmit channel when it is EXT or EX2, and the receive/transmit channel when it is BTH. Tracks set to INT which have the same MIDI channel will sound and be controlled identically when they receive MIDI data or data from the sequencer tracks.

**Bank Select MSB (When Status=EX2) [000...127]**

**Bank Select LSB (When Status=EX2) [000...127]**

When **Status** is set to EX2, this sets the bank number that will be transmitted. When **Status** is other than EX2, this setting has no effect.

**Track Priority [Off, On]**

This lets you protect a Track's voices from being stolen by other, non-priority Tracks.

If a new note-on would exceed the available number of voices, one or more currently-sounding voice will be stopped ("stolen") to make room for the new voice. If **Track Priority** is **On**, then the Track's voices can only be stolen by other priority voices; all voices with **Track Priority Off** will be stolen first.

In a Song with many active Tracks, you can enable **Track Priority** for sounds with an important musical role, such as drums or bass. In general, you can enable it for any Track for which note stealing would adversely affect the overall sound.

**Important:** this setting will have little meaning if it is turned on for more than a few Tracks. It's a good idea to start with **Track Priority** un-checked for all Tracks, and only turn it on as necessary.

**On (checked):** The Track's voices will be given priority in voice-stealing.

**Off (un-checked):** The Track's voices will not be given priority in voice-stealing.

**Track 02...16 (Track Number)**

These are the MIDI-related settings for MIDI tracks 2 through 16. They are the same as for track 1. See "Track 01":.

- 2: **Rename Song.** For more information, see "Rename Song" on page 624.
- 3: **Initialize Song.** For more information, see "Initialize Song" on page 624.
- 4: **Copy From Song.** For more information, see "Copy From Song" on page 624.
- 5: **Load Template Song.** For more information, see "Load Template Song" on page 624.
- 6: **Save Template Song.** For more information, see "Save Template Song" on page 625.
- 7: **FF/REW Speed.** For more information, see "FF/REW Speed" on page 625.
- 8: **Set Location (for Locate Key.)** For more information, see "Set Location (for Locate Key)" on page 626.
- 9: **GM Initialize.** For more information, see "GM Initialize" on page 626.
- 10: **Copy From Combination.** For more information, see "Copy from Combination" on page 626.
- 11: **Copy From Program.** For more information, see "Copy From Program" on page 626.

**▼ 2-1: Page Menu Commands**

The number before each command shows its ENTER + number-key shortcut. For more information on these shortcuts, see "ENTER + 0-9: shortcuts for menu commands" on page 147.

- 0: **Memory Status.** For more information, see "Memory Status" on page 624.
- 1: **Exclusive Solo.** For more information, see "Exclusive Solo" on page 147.

## 2-2: OSC

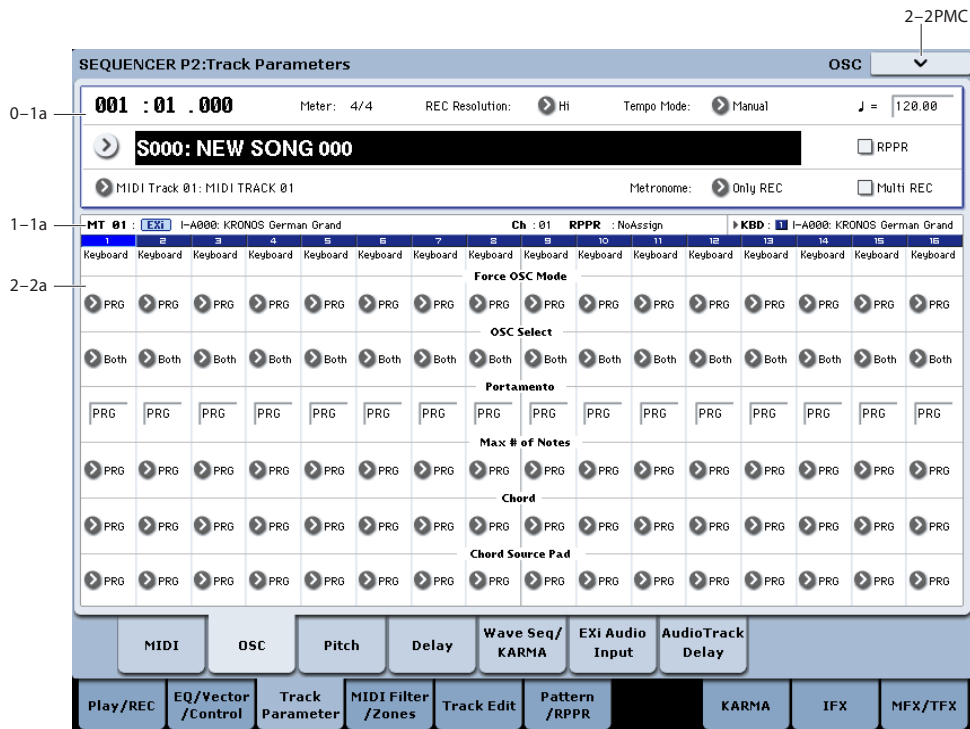

These parameters specify how each MIDI track will be sounded.

### 2-2a: OSC

#### Track 01 (Track Number)

#### Force OSC Mode [PRG, Poly, MN, LGT]

This lets you override the Program's stored Voice Assign Mode settings, if desired.

For more information, please see "Force OSC Mode" on page 455.

#### OSC Select [BTH, OS1, OS2]

Specifies whether the MIDI track's program will play OSC1/EX1, OSC2/EX2, or both.

For HD-1 programs whose **Oscillator Mode** (Program 1-1b) is Double, this setting lets you specify that only OSC1 or OSC2 will sound. For EXi programs which use two EXi instruments, this setting lets you specify that only EXi1 or EXi2 will sound. For more information, please see "OSC Select" on page 455.

#### Portamento [PRG, Off, 001...127]

Make portamento settings for each MIDI track. For more information, please see "Portamento" on page 456.

The portamento setting you make here will be used when the song is played or recorded from the beginning. If you change the setting while recording, it will be recorded as part of the musical data. (However if you set this to PRG, it will not be recorded.) You can change this setting during playback. However if you

come to any Portamento On/Off data or Portamento Time data that was recorded, the settings will change accordingly.

When the track whose **Status** (2-1a) is INT or BTH, MIDI control change CC#5 (Portamento Time) and CC#65 (Portamento Switch) can be received to control this and change the setting. (If the setting is PRG, CC#05 Portamento Time will not be received.)

When you switch songs or return to the beginning of the song, tracks whose **Status** is BTH, EXT, or EX2 will transmit this setting via MIDI. If this is Off, CC#65 with a value of 0 will be transmitted. If this is 001-127, a CC#65 of 127 and CC#05 of 1-127 will be transmitted.

If this is set to PRG, nothing will be transmitted.

This data is transmitted and received on the MIDI channel specified for each track by **MIDI Channel** (2-1a).

#### Max # of Notes [Dynamic, 1...16]

**Dynamic** is the default. With this setting, you can play as many notes as the system allows.

**1-16** lets you limit the maximum number of notes played by the Track. Voices will still be allocated dynamically, up to this maximum number. You can use this to:

- Model the voice-leading of vintage synthesizers, such as the Polysix
- Control the resources required by the Track, so that more voices can play on other Tracks

**Max # of Notes** applies only when the Program's **Voice Assign Mode** is set to **Poly**, or when **Force Osc Mode** has been set to **Poly**. With **Mono**, it has no effect.

This setting does not limit the **Unison Number of Voices**. For instance, if **Max # of Notes** is set to 6, and **Unison Number of Voices** is set to 3, you can play up to 6 notes, each with 3 Unison voices.

In double Programs, the **Max # of Notes** applies equally to both OSC or EXi. For instance, if **Max # of Notes** is set to 4, you can play up to 4 notes on each OSC/EXi.

### **Chord** [PRG, Off, Bsc, Adv]

**PRG** uses the Program's setting. If the Program is set to **Off**, then the Chord SW has no effect.

**Off** disables the Chord function.

**Bsc** (Basic) re-creates the chord mode of the original Polysix. Each time you play a new chord, it will cut off the previous chord. This option ignores the Voice Assign settings.

**Adv** (Advanced) uses the Program's Voice Assign settings, as if each note in the chord was a transposed set of oscillators layered within the Program.

Poly, Poly Legato, Single Trigger, Mono, Mono Legato, Legato Offset, Mono Priority, and Mono and Poly Unison all apply.

You can achieve the same effect as **Bsc**, above, by setting **Chord** to **Advanced**, **Voice Assign** to **Mono**, **Priority** to **Last Note**, and **Legato** to **Off**.

For more information, see "Using Chord mode" on page 36 of the Operation Guide.

### **Source Pad** [PRG, 1...8]

Chord mode uses the chords assigned to the Pads. This selects which of the Pads to use. You can also select chords using the Pads themselves; for more information, see "Using Chord mode" on page 36 of the Operation Guide.

**PRG** uses the notes of the chord stored in the Track's Program, instead of any of the chords in the Combi. This makes it easy to use Chord mode for sound-specific effects, such as octaves, stacked fifths, and so on. When set to **PRG**, the Track will not change chords in response to the pads.

### **Track 02... 16 (Track Number)**

Here you can make OSC settings for MIDI tracks 2 through 16. These are the same as for track 1. See "Track 01:".

- 4: **Copy From Song**. For more information, see "Copy From Song" on page 624.
- 5: **Load Template Song**. For more information, see "Load Template Song" on page 624.
- 6: **Save Template Song**. For more information, see "Save Template Song" on page 625.
- 7: **FF/REW Speed**. For more information, see "FF/REW Speed" on page 625.
- 8: **Set Location** (for Locate Key.) For more information, see "Set Location (for Locate Key)" on page 626.
- 9: **GM Initialize**. For more information, see "GM Initialize" on page 626.
- 10: **Copy From Combination**. For more information, see "Copy from Combination" on page 626.
- 11: **Copy From Program**. For more information, see "Copy From Program" on page 626.

## ▼ 2-2: Page Menu Commands

The number before each command shows its ENTER + number-key shortcut. For more information on these shortcuts, see "ENTER + 0-9: shortcuts for menu commands" on page 147.

- 0: **Memory Status**. For more information, see "Memory Status" on page 624.
- 1: **Exclusive Solo**. For more information, see "Exclusive Solo" on page 147.
- 2: **Rename Song**. For more information, see "Rename Song" on page 624.
- 3: **Initialize Song**. For more information, see "Initialize Song" on page 624.

## 2-3: Pitch

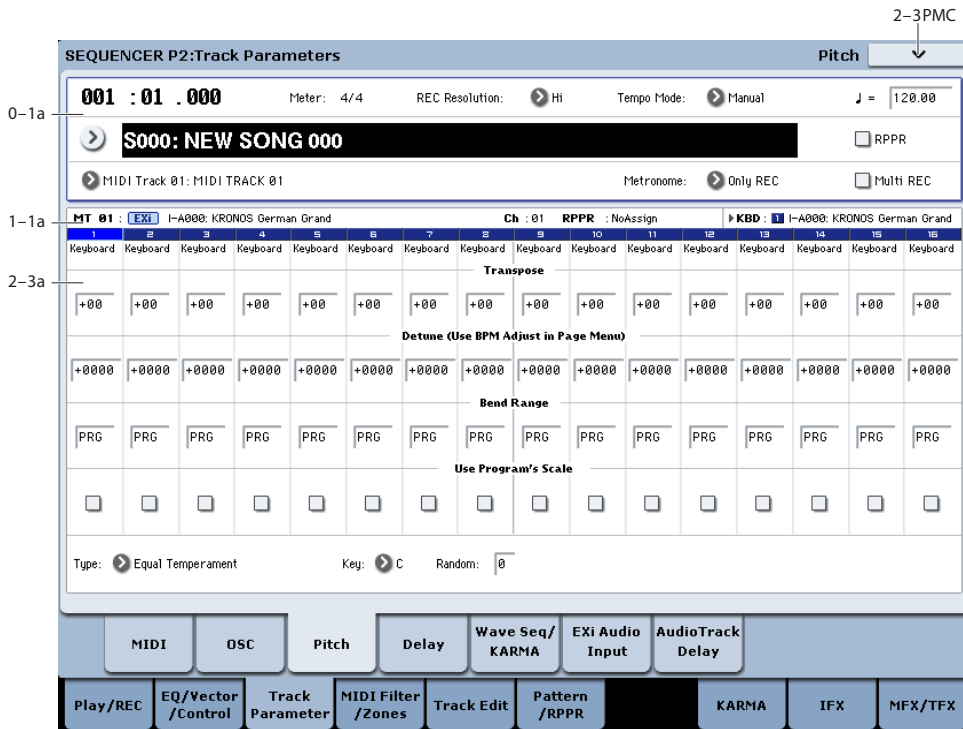

Here you can make pitch-related settings for each MIDI track.

### 2-3a: Pitch

#### Track 01 (Track Number)

##### Transpose [-60...+00...+60]

Adjusts the pitch of each MIDI track in semitone steps. 12 units equal one octave.

##### Detune (BPM Adj. in Page Menu) [-1200...+0000... +1200]

Adjusts the pitch of each MIDI track in one-cent units. +0000: Normal pitch.

*Note:* You can also use the “Detune BPM Adjust” page menu command to automatically make a detune setting from a calculation in BPM units.

**MIDI** **Transpose** and **Detune** do not affect the notes transmitted via MIDI Out.

**MIDI** **Transpose** and **Detune** can be controlled via MIDI RPN messages received on the Track’s MIDI channel. The way that this works depends on whether or not the Track uses an HD-1 Drum Program.

If the Track does not use an HD-1 Drum Program—for example, if it uses a Single or Double HD-1 Program, or an EXi Program—then MIDI RPN Coarse Tune will control **Transpose**, and RPN Fine Tune will control **Detune**.

If the Track uses an HD-1 Drum Program, MIDI RPN Coarse Tune and Fine Tune will be combined to control **Detune**. The overall range is ±1 octave for coarse tune and fine tune together.

##### Bend Range [PRG, -24...+00...+24]

Specifies the amount of pitch change that will occur when the pitch bender is operated, in semitone units.

**PRG:** The pitch range specified by the program will be used.

-24...+24: This setting will be used regardless of the setting in the program.

**MIDI** As long as this set to something other than PRG, you can control the **Bend Range** using MIDI RPN Pitch Bend Change messages. (See KARMA “Transmit MIDI Filter,” “Pitch Bend” 7-2a)

##### Use Program’s Scale [Off, On]

MIDI track can use the scale that is specified by Scale (Program 1-1f).

**On (checked):** The scale specified by the program will be used.

**Off (unchecked):** The scale specified by Scale (2-3b) will be used.

#### Track 2... 16 (Track Number)

Here you can make pitch-related settings for MIDI tracks 2 through 16. The settings are the same as for track 1, as described above.

### 2-3b: Scale

#### Scale

Specifies the scale that the song will use. For more information, please see “1-1g: Scale” on page 41.

##### Type (Song’s Scale) [Equal Temperament...User Octave Scale15]

Selects the scale.

**Key** [C...B]

Selects the tonic key of the selected scale.

**Random** [0...7]

As this value is increased, an increasingly random deviation will be added to the pitch at each note-on.

**MIDI** If **Status** (2-1a) is INT, this setting will affect the pitch produced by the KRONOS. If **Status** is EXT, this setting will affect the note number of the note messages transmitted via MIDI.

---

**▼ 2-3: Page Menu Commands**

The number before each command shows its ENTER + number-key shortcut. For more information on these shortcuts, see "ENTER + 0-9: shortcuts for menu commands" on page 147.

- 0: **Memory Status**. For more information, see "Memory Status" on page 624.
- 1: **Exclusive Solo**. For more information, see "Exclusive Solo" on page 147.
- 2: **Rename Song**. For more information, see "Rename Song" on page 624.
- 3: **Initialize Song**. For more information, see "Initialize Song" on page 624.
- 4: **Copy From Song**. For more information, see "Copy From Song" on page 624.
- 5: **Load Template Song**. For more information, see "Load Template Song" on page 624.
- 6: **Save Template Song**. For more information, see "Save Template Song" on page 625.
- 7: **FF/REW Speed**. For more information, see "FF/REW Speed" on page 625.
- 8: **Set Location** (for Locate Key.) For more information, see "Set Location (for Locate Key)" on page 626.
- 9: **GM Initialize**. For more information, see "GM Initialize" on page 626.
- 10: **Copy From Combination**. For more information, see "Copy from Combination" on page 626.
- 11: **Copy From Program**. For more information, see "Copy From Program" on page 626.
- 12: **Detune BPM Adjust**. For more information, see "Detune BPM Adjust" on page 635.

## 2-4: Delay

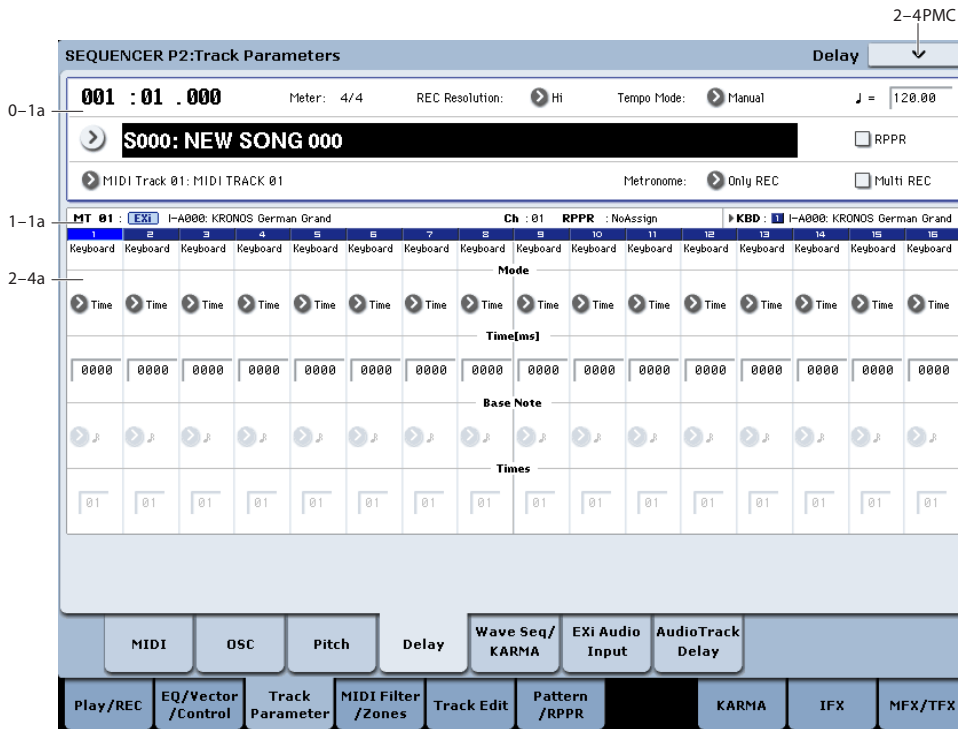

This specifies the time (delay) from when the MIDI track receives a note-on until the sound begins.

### 2-4a: Delay

#### Track 01 (Track Number)

**Mode** [Time, Tempo]

This selects whether the Track delay will be set in milliseconds, or in rhythmic units.

**Time:** Specify the delay time in units of milliseconds (ms = 1/1000th of a second).

**Tempo:** Specify the delay time in terms of a **Base Note** and **Times** relative to the system tempo. For example if **Base Note** = ♩, **Times** = 01, and **Tempo** = 60 BPM, the delay time will be equivalent to 1000 ms.

**Time [ms]** [0000...6000, KeyOff]

Specifies the time (delay time) from note-on until the MIDI track begins to produce sound, in units of ms (1/1000th of a second). This setting is available if "Mode" is set to Time.

**KeyOff:** The note will begin sounding at note-off. In this case, the sound will not die away if the sustain level of the program's amp EG is other than 0. This setting is used when creating harpsichord sounds.

Normally you will set this to 0000.

**Base Note** [♩...♩]

**Times** [01...32]

This setting is available is "Mode" is set to Tempo. It specifies the time (delay time) from note-on until the MIDI track begins to produce sound, in terms of a note value relative to the "Tempo (♩)" (0-1a).

Use **Base Note** to specify the desired note value, and use **Times** to extend that note value by the specified multiple.

For example if you set **Base Note** to a quarter note (♩) and **Times** to 02, that MIDI track will sound with a delay of a half note (♩). Even if you change "Tempo (♩)" (0-1a), the delay time will always be a half note (♩). If you use these parameters to specify a delay of a half note (♩). In this case, a **Tempo** of 60.00 BPM will produce a 2000 ms delay, and a **Tempo** of 120.00 BPM will produce a 1000 ms delay.

#### Track 02... 16 (Track Number)

These are the delay time settings for MIDI tracks 2 through 16. They are the same as for track 1. See "Track 01":.

### ▼ 2-4: Page Menu Commands

The number before each command shows its ENTER + number-key shortcut. For more information on these shortcuts, see "ENTER + 0-9: shortcuts for menu commands" on page 147.

- 0: **Memory Status.** For more information, see "Memory Status" on page 624.
- 1: **Exclusive Solo.** For more information, see "Exclusive Solo" on page 147.
- 2: **Rename Song.** For more information, see "Rename Song" on page 624.
- 3: **Initialize Song.** For more information, see "Initialize Song" on page 624.
- 4: **Copy From Song.** For more information, see "Copy From Song" on page 624.

- 5: **Load Template Song.** For more information, see “Load Template Song” on page 624.
- 6: **Save Template Song.** For more information, see “Save Template Song” on page 625.
- 7: **FF/REW Speed.** For more information, see “FF/REW Speed” on page 625
- 8: **Set Location** (for Locate Key.) For more information, see “Set Location (for Locate Key)” on page 626.
- 9: **GM Initialize.** For more information, see “GM Initialize” on page 626.
- 10: **Copy From Combination.** For more information, see “Copy from Combination” on page 626.
- 11: **Copy From Program.** For more information, see “Copy From Program” on page 626.

## 2-5: Wave Sequence/KARMA

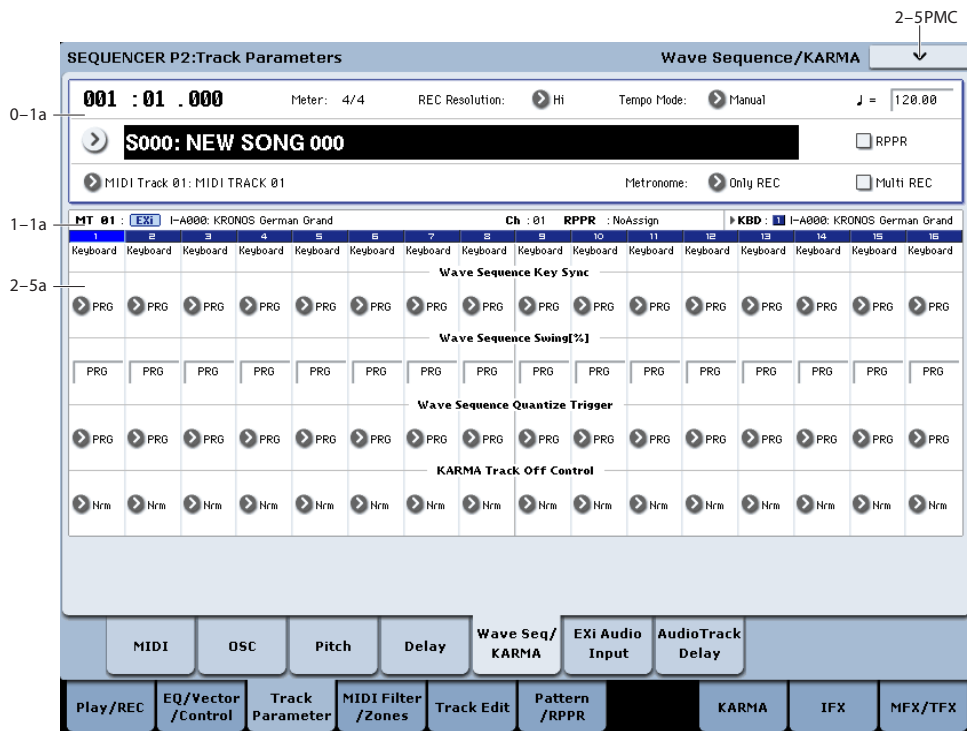

Here you can make settings related to wave sequence and KARMA functionality for each MIDI track.

### 2-5a: Wave Sequence/KARMA

#### Track 01 (Track Number)

#### Wave Sequence Key Sync [PRG, Off, On]

Specifies the wave sequence **Key Sync** setting (Program 1-1e) of the program selected for the MIDI track. This setting is valid if the program uses a wave sequence.

**PRG:** The setting of the program is used.

**Off:** **Key Sync** is forced off. The wave sequence of each note will synchronize to the same step.

**On:** **Key Sync** is forced on. The wave sequence will start each time you press a key. If the wave sequences have differing steps or rates, they will proceed independently.

For more information, please see “Key Sync” on page 40.

#### Wave Sequence Swing% [PRG, -300...+300]

Specifies the wave sequence “Swing” setting (Program 1-1e) of the program selected for the MIDI track. This setting is valid if the program uses a wave sequence.

**PRG:** The setting of the program is used.

**-300...+300:** The Swing% specified here is used regardless of the program’s “Swing%” setting.

For more information, please see “Swing” on page 39.

#### Wave Sequence Quantize Trigger [PRG, Off, On]

This allows you to override the Program’s Wave Sequence “Quantize Trigger” setting (Program 1-1e). If you’re using multiple Programs with rhythmic Wave Sequences, you can use this to synchronize all of the Wave Sequences at note-on.

Note that Quantize Trigger applies only when the Wave Sequence’s **Mode** is set to Tempo. For more information, see “Mode” on page 788.

**PRG:** The setting of the program is used.

**Off:** “Quantize Trigger” is forced off. The wave sequence will trigger immediately after note-on.



**On:** “Quantize Trigger” is forced on. The wave sequence pattern will synchronize to eighth-note timing of the currently-sounding wave sequence; i.e., the trigger will be quantized.

For more information, please see “Quantize Trigger” on page 40.

### **KARMA Track Off Control [Normal, Track Off by KARMA Off, Track Off by KARMA On]**

**Nrm (Normal):** The KARMA ON/OFF switch will not control whether the track will sound. Usually you will use the Normal setting.

**by Off (Track Off by KARMA Off):** The track will sound as usual when the KARMA ON/OFF switch is on.

The track will not sound when the KARMA ON/OFF switch is off.

Use this when you want a specific track of multiple tracks set to the same MIDI channel to be silent only when KARMA is off.

**by On (OSC Off by KARMA On):** The track will not sound when the KARMA ON/OFF switch is on.

The track will sound as usual when the KARMA ON/OFF switch is off.

Use this when you are using a KARMA Module to control multiple tracks that are set to the same MIDI channel, and want a specific track to be silent only when KARMA is on.

For example you can use this to play a two-track layer from the keyboard when KARMA is off, and use one track to sound the phrase when KARMA is on.

If the **Status** (0–1b) of each track is INT, you can use the “Track On/Off Ctrl” setting to stop the oscillator of each track from sounding.

 If you set “OSC On/Off Ctrl” to by Off or by On settings and operate the KARMA ON/OFF switch while real-time-recording a song, you must be aware of the following points.

- In order to control this parameter during playback, operations of the KARMA ON/OFF switch must be recorded in real-time.
- Set “KARMA ON/OFF” (Global 2–1b) to MIDI CC#14. If this is assigned to MIDI CC#14, operations of the KARMA ON/OFF switch can be recorded in real-time. (See “2–1b: MIDI CC# Assign – KARMA Controllers” on page 781)
- Operations will also be recorded if you assign this key to MIDI CC#00–95, but in order to avoid confusion when receiving another CC#, you should use CC#14.
- “KARMA ON/OFF” (Global 2–1b) will also be set to MIDI CC#14 if you execute the page menu command “Reset Controller MIDI Assign” with “To:” set to Default Setting. After executing, turn the assignment Off for other MIDI CC# Assign – KARMA Controllers that you do not need to record.

### **Track 02...16 (Track Number)**

These are the wave sequence and KARMA-related settings for MIDI tracks 2 through 16. They are the same as for track 1. See “Track 01”.

## ▼ 2–5: Page Menu Commands

The number before each command shows its ENTER + number-key shortcut. For more information on these shortcuts, see “ENTER + 0–9: shortcuts for menu commands” on page 147.

- **0: Memory Status.** For more information, see “Memory Status” on page 624.
- **1: Exclusive Solo.** For more information, see “Exclusive Solo” on page 147.
- **2: Rename Song.** For more information, see “Rename Song” on page 624.
- **3: Initialize Song.** For more information, see “Initialize Song” on page 624.
- **4: Copy From Song.** For more information, see “Copy From Song” on page 624.
- **5: Load Template Song.** For more information, see “Load Template Song” on page 624.
- **6: Save Template Song.** For more information, see “Save Template Song” on page 625.
- **7: FF/REW Speed.** For more information, see “FF/REW Speed” on page 625.
- **8: Set Location (for Locate Key.)** For more information, see “Set Location (for Locate Key)” on page 626.
- **9: GM Initialize.** For more information, see “GM Initialize” on page 626.
- **10: Copy From Combination.** For more information, see “Copy from Combination” on page 626.
- **11: Copy From Program.** For more information, see “Copy From Program” on page 626.

## 2-6: EXi Audio Input

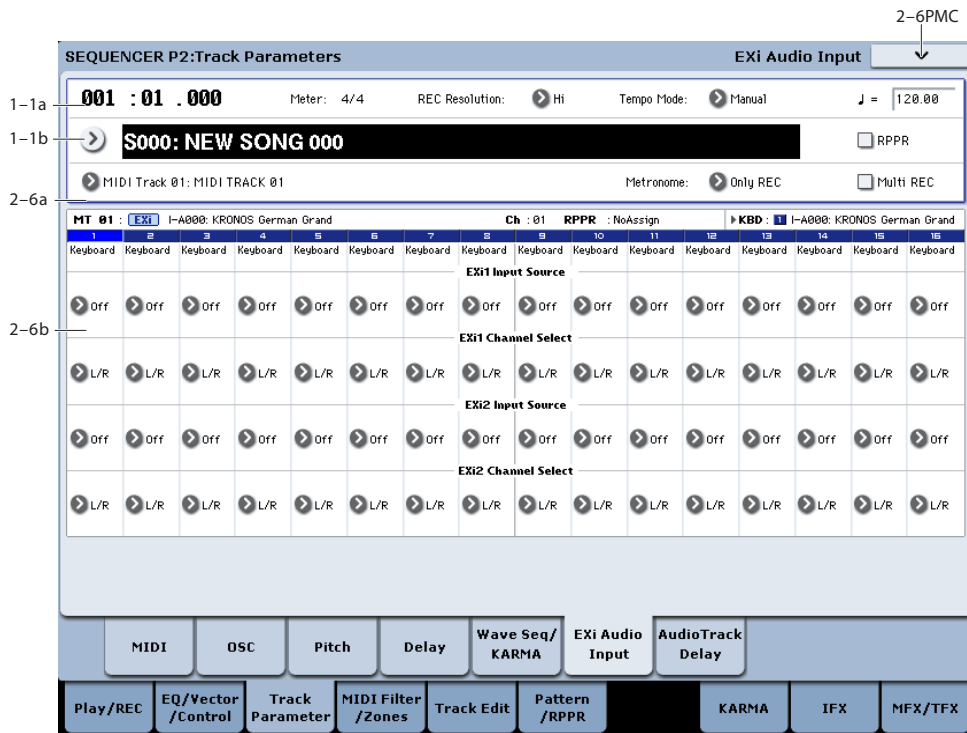

These parameters let you route audio into EXi instruments which support audio input, including the STR-1, MS-20EX, and MOD-7. You can use this to create feedback loops, or to process live or recorded audio through the EXi's synthesis engine.

EXi which do not support audio input will ignore these settings. The AL-1 supports audio input, but uses its own dedicated routing which is not affected by these parameters.

For more information on using audio inputs with EXi, see:

AL-1: "4-3c: Sub OSC/Audio Input" on page 191

STR-1: "4-8c: Feedback" on page 271

MS-20EX: "6-1k: EXTERNAL SIGNAL PROCESSOR (ESP)" on page 313

MOD-7: "5-1f: EXi Audio Input" on page 359

### 2-6a: EXi 1

**Input Source** [PRG, Off, Audio Input 1/2, USB 1/2, S/P DIF Input L/R, L/R Output, Indiv. Output 1/2...3/4, REC 1/2...3/4, FX Control 1, 2, IFX 1...12, MFX 1, 2, TFX 1, 2]

This selects the input source for EXi1. You can use this to create a feedback loop, if desired.

**PRG** uses the setting stored in the Program. You may find this convenient if you use Program Change messages to switch between two EXi Programs, and wish to have the input enabled for one, but disabled for the other. For more information, see "4-2: EXi Audio Input" on page 174.

**Off** disables the input.

**Audio Input 1/2, USB 1/2, and S/P DIF Input L/R** use the live audio from the selected input.

**L/R Output and Indiv. Output 1/2...3/4** use the audio as it is heard from the selected output (like connecting a cable from the output back to the input).

**REC 1/2...3/4 and FX Control 1, 2** use the audio from the selected bus.

**IFX 1...12, MFX 1, 2, and TFX 1, 2** use the output of the selected effect.

#### Channel Select [Stereo/L+R, Left, Right]

**Stereo/L+R:** This selection routes a stereo signal to EXi with stereo inputs, and an L+R summation to EXi with mono inputs.

**Left, Right:** This uses only a mono signal from the selected channel.

### 2-6b: EXi 2

EXi 2 has the same controls as EXi 1, above.

### 2-6: Page Menu Commands

The number before each command shows its ENTER + number-key shortcut. For more information on these shortcuts, see "ENTER + 0-9: shortcuts for menu commands" on page 147.

- 0: **Memory Status.** For more information, see "Memory Status" on page 624.
- 1: **Exclusive Solo.** For more information, see "Exclusive Solo" on page 147.
- 2: **Rename Song.** For more information, see "Rename Song" on page 624.

- 3: **Initialize Song.** For more information, see “Initialize Song” on page 624.
- 4: **Copy From Song.** For more information, see “Copy From Song” on page 624.
- 5: **Load Template Song.** For more information, see “Load Template Song” on page 624.
- 6: **Save Template Song.** For more information, see “Save Template Song” on page 625.
- 7: **FF/REW Speed.** For more information, see “FF/REW Speed” on page 625
- 8: **Set Location** (for Locate Key.) For more information, see “Set Location (for Locate Key)” on page 626.
- 9: **GM Initialize.** For more information, see “GM Initialize” on page 626.
- 10: **Copy From Combination.** For more information, see “Copy from Combination” on page 626.
- 11: **Copy From Program.** For more information, see “Copy From Program” on page 626.

## 2-7: Audio Track Delay

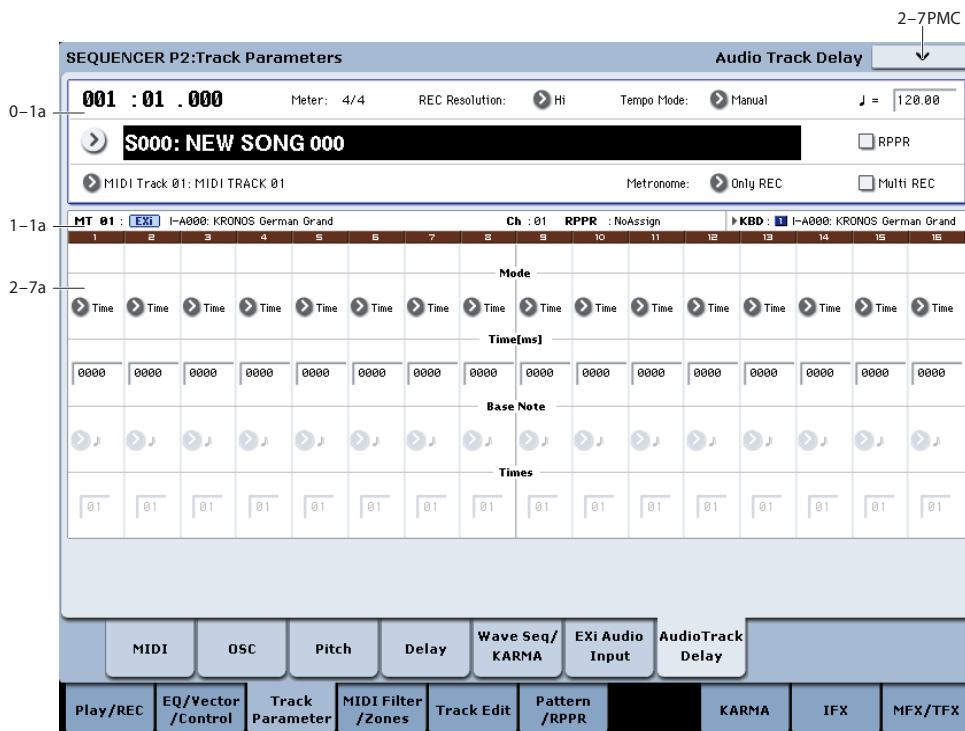

Here you can specify a delay time by which the audio events of each audio track will be delayed relative to their “Location.”

### 2-7a: Delay

#### Track 01...16 (Track Number)

#### STEREO

This is shown if **Stereo Pair** is on.

<b>Mode</b>	[Time, Tempo]
<b>Time [ms]</b>	[0000...6000]
<b>Base Note</b>	[♪, ♪, ♪, ♪, ♪, ♪, ♪, ♪, ♪, ♪, ♪, ♪, ♪, ♪, ♪, ♪]
<b>Times</b>	[01...32]

For more information, please see “2-4a: Delay” on page 570.

### ▼ 2-7: Page Menu Commands

The number before each command shows its ENTER + number-key shortcut. For more information on these shortcuts, see “ENTER + 0-9: shortcuts for menu commands” on page 147.

- 0: **Memory Status.** For more information, see “Memory Status” on page 624.
- 1: **Exclusive Solo.** For more information, see “Exclusive Solo” on page 147.
- 2: **Rename Song.** For more information, see “Rename Song” on page 624.
- 3: **Initialize Song.** For more information, see “Initialize Song” on page 624.
- 4: **Copy From Song.** For more information, see “Copy From Song” on page 624.
- 5: **Load Template Song.** For more information, see “Load Template Song” on page 624.
- 6: **Save Template Song.** For more information, see “Save Template Song” on page 625.

- **7: FF/REW Speed.** For more information, see “FF/REW Speed” on page 625
- **8: Set Location** (for Locate Key.) For more information, see “Set Location (for Locate Key)” on page 626.
- **9: GM Initialize.** For more information, see “GM Initialize” on page 626.
- **10: Copy From Combination.** For more information, see “Copy from Combination” on page 626.
- **11: Copy From Program.** For more information, see “Copy From Program” on page 626.

# Sequencer P3: MIDI Filter/Zones

## 3-1: MIDI Filter1

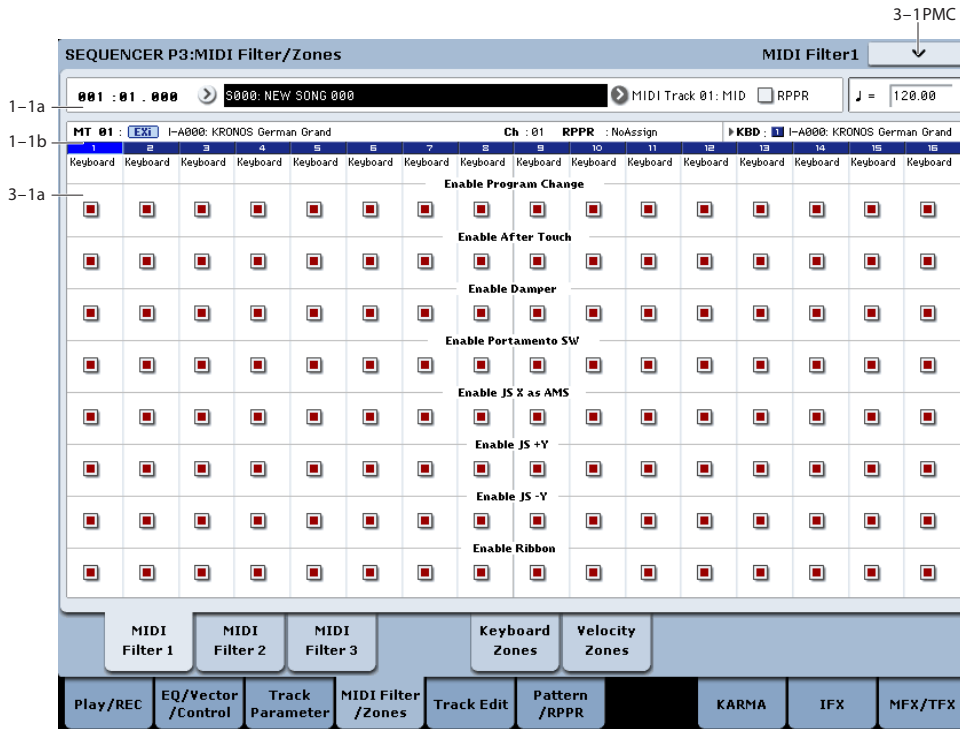

Here you can select whether or not to apply filtering to the MIDI data received by MIDI tracks 1–16. For example even if two tracks are receiving the same MIDI channel, one can be set to respond to damper pedal activity while the other does not.

**MIDI** These MIDI filter settings have no effect on the MIDI messages that have already been recorded.

**MIDI** These settings affect the MIDI messages that are transmitted when you adjust program, pan, volume, portamento and send 1/2 parameters of a track whose **Status** (2–1a) is set to BTH, EXT, or EX2.

**On (checked):** Reception of MIDI data is enabled. Tracks whose **Status** (2–1a) is INT or BTH will receive these types of MIDI messages on their respective channels. The type of effects that are checked will be applied to the program of each track when the KRONOS’s controllers are operated or when MIDI data is received. (The effect dynamic modulation function is not affected by these settings.)

Settings that regulate MIDI transmission/reception of the KRONOS itself are made in MIDI Filter (Global 1–1c).

If the user-assignable controllers that can be filtered in the MIDI Filter 2 and 3 pages are set to MIDI control changes, filtering will be performed for these control changes. In this case, any control change filtering that is being performed in the MIDI Filter 1 and 2 pages will be given priority. Furthermore, if the same control change is assigned to multiple controllers for which there are filter settings in the MIDI Filter 2 and 3 pages, checking any one of these will enable that control change.

**Off (unchecked):** Reception of MIDI data is disabled.  
*Note:* MIDI CC# = MIDI control change message numbers.

### 3-1a: MIDI Filter 1

#### Track 01 (Track Number)

**Enable Program Change** [Off, On]  
 Specifies whether or not MIDI program change messages will be received.

**Enable After Touch** [Off, On]  
 Specifies whether or not MIDI after touch messages will be received.

**Enable Damper** [Off, On]  
 Specifies whether or not MIDI CC#64 hold (damper pedal) messages will be received.

**Enable Portamento SW** [Off, On]  
 Specifies whether or not MIDI CC#65 portamento on/off messages will be received.

**Enable JS X as AMS** [Off, On]  
 Specifies whether or not MIDI pitch bend messages (the X axis of the KRONOS’s joystick) will be received to control the AMS effect assigned to JS X. (This is not a filter for MIDI pitch bend message reception.) For more information, please see “Alternate Modulation Sources (AMS)” on page 1089.

**Enable JS+Y [Off, On]**

Specifies whether or not MIDI CC#1 (the +Y axis of the KRONOS's joystick, or a Modulation Knob Assign setting) will be received.

**Enable JS-Y [Off, On]**

Specifies whether or not MIDI CC#2 (the -Y axis of the KRONOS's joystick, or a Modulation Knob Assign setting) will be received.

**Enable Ribbon [Off, On]**

Specifies whether or not MIDI CC#16 (the KRONOS's ribbon controller, or specified as the assignment of a realtime modulation knob) will be received.

**Track 02... 16 (Track Number)**

These are the MIDI Filter 1 settings for MIDI tracks 2 through 16. They are the same as for track 1. See "Track 01:".

---

**▼ 3-1: Page Menu Commands**

The number before each command shows its ENTER + number-key shortcut. For more information on these shortcuts, see "ENTER + 0-9: shortcuts for menu commands" on page 147.

- 0: **Memory Status**. For more information, see "Memory Status" on page 624.
- 1: **Exclusive Solo**. For more information, see "Exclusive Solo" on page 147.
- 2: **Rename Song**. For more information, see "Rename Song" on page 624.
- 3: **Initialize Song**. For more information, see "Initialize Song" on page 624.
- 4: **Copy From Song**. For more information, see "Copy From Song" on page 624.
- 5: **Load Template Song**. For more information, see "Load Template Song" on page 624.
- 6: **Save Template Song**. For more information, see "Save Template Song" on page 625.
- 7: **FF/REW Speed**. For more information, see "FF/REW Speed" on page 625.
- 8: **Set Location** (for Locate Key.) For more information, see "Set Location (for Locate Key)" on page 626.
- 9: **GM Initialize**. For more information, see "GM Initialize" on page 626.
- 10: **Copy From Combination**. For more information, see "Copy from Combination" on page 626.
- 11: **Copy From Program**. For more information, see "Copy From Program" on page 626.

### 3-2: MIDI Filter2

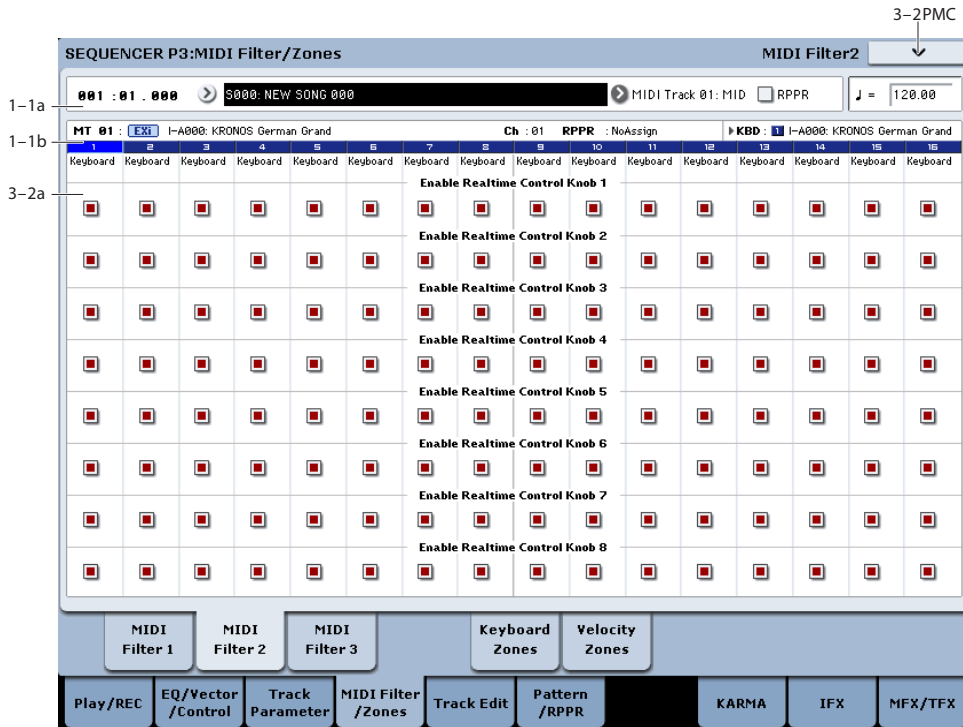

Here you can enable transmission for the REALTIME CONTROLS 1-8 knobs. The MIDI control messages of knobs 1-4 are fixed. The function of knobs 5-8 can be assigned in the Set Up Controllers page.

#### 3-2a: MIDI Filter 2

##### Track 01 (Track Number)

##### Enable Realtime Control Knob 1 [Off, On]

Specifies whether Realtime Control knob 1 MIDI CC#74 (the KRONOS's filter cutoff frequency) will be received.

##### Enable Realtime Control Knob 2 [Off, On]

Specifies whether or not Realtime Control knob 2 MIDI CC#71 (the KRONOS's filter resonance) will be received.

##### Enable Realtime Control Knob 3 [Off, On]

Specifies whether or not Realtime Control knob 3 MIDI CC#79 (the KRONOS's filter EG intensity) will be received.

##### Enable Realtime Control Knob 4 [Off, On]

Specifies whether or not Realtime Control knob 4 MIDI CC#72 (the KRONOS's filter/amp EG release time) will be received.

##### Enable Realtime Control Knob 5 [Off, On]

##### Enable Realtime Control Knob 6 [Off, On]

##### Enable Realtime Control Knob 7 [Off, On]

##### Enable Realtime Control Knob 8 [Off, On]

These specify whether or not MIDI message will be received for Realtime Control knobs 5 through 8.

##### Track 02... 16 (Track Number)

These are the MIDI Filter 2 settings for MIDI tracks 2 through 16. They are the same as for track 1. See "Track 01:".

#### ▼ 3-2: Page Menu Commands

The number before each command shows its ENTER + number-key shortcut. For more information on these shortcuts, see "ENTER + 0-9: shortcuts for menu commands" on page 147.

- 0: **Memory Status**. For more information, see "Memory Status" on page 624.
- 1: **Exclusive Solo**. For more information, see "Exclusive Solo" on page 147.
- 2: **Rename Song**. For more information, see "Rename Song" on page 624.
- 3: **Initialize Song**. For more information, see "Initialize Song" on page 624.
- 4: **Copy From Song**. For more information, see "Copy From Song" on page 624.
- 5: **Load Template Song**. For more information, see "Load Template Song" on page 624.



- 6: **Save Template Song.** For more information, see “Save Template Song” on page 625.
- 7: **FF/REW Speed.** For more information, see “FF/REW Speed” on page 625
- 8: **Set Location** (for Locate Key.) For more information, see “Set Location (for Locate Key)” on page 626.
- 9: **GM Initialize.** For more information, see “GM Initialize” on page 626.
- 10: **Copy From Combination.** For more information, see “Copy from Combination” on page 626.
- 11: **Copy From Program.** For more information, see “Copy From Program” on page 626.

### 3-3: MIDI Filter3

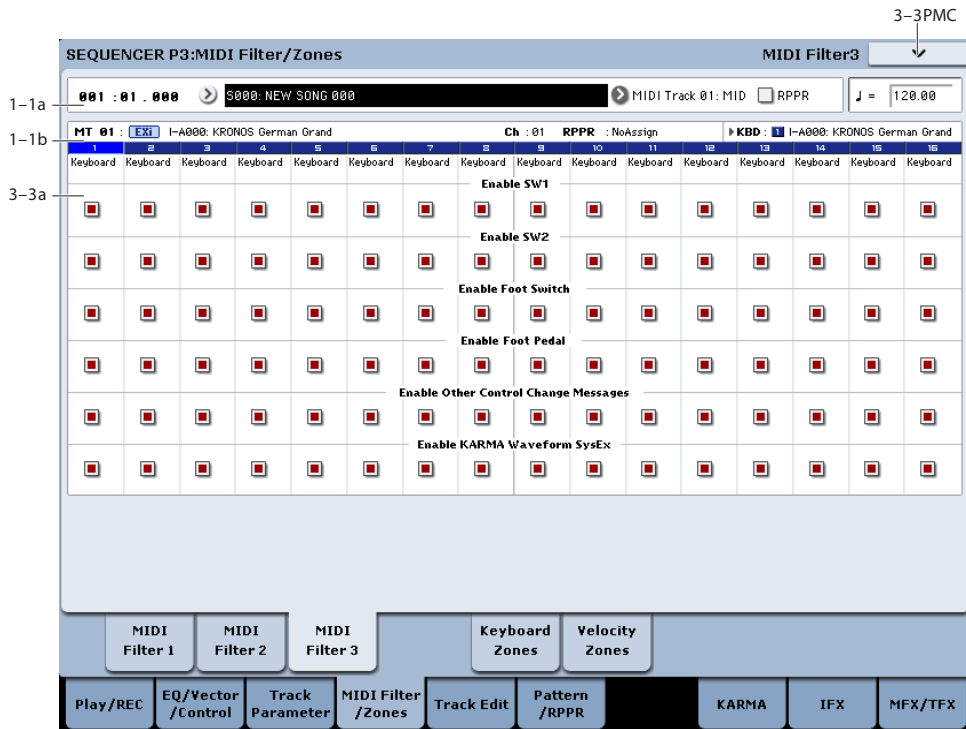

#### 3-3a: MIDI Filter 3

##### Track 01 (Track Number)

**Enable SW1** [Off, On]

**Enable SW2** [Off, On]

Specifies whether or not the effect of the SW1 and SW2 switches will be received.

The function of these switches is specified in the Set Up Controllers page.

These settings are valid if these keys are assigned to SW1 Mod. (CC#80), SW2 Mod. (CC#81), or Portamento SW (CC#65).

**Enable Foot Switch** [Off, On]

Specifies whether or not the effect of the ASSIGNABLE SWITCH will be received. The function is assigned in Global P2- Controller page.

This filter setting is valid when a MIDI control change is assigned.

**Enable Foot Pedal** [Off, On]

Specifies whether or not the effect of the ASSIGNABLE PEDAL will be received. The function is assigned in Global P2- Controller page.

This filter setting is valid when a MIDI control change is assigned.

**Enable Other Control Change Messages** [Off, On]

Specifies whether or not MIDI control messages not covered in the preceding items MIDI Filter will be received.

**Enable KARMA Waveform SysEx** [Off, On]

This allows you to enable or disable the System Exclusive messages used by KARMA Wave Sequencing.

##### Track 02... 16 (Track Number)

These are the MIDI Filter 3 settings for MIDI tracks 2 through 16. They are the same as for track 1, as described above.

### ▼ 3-3: Page Menu Commands

The number before each command shows its ENTER + number-key shortcut. For more information on these shortcuts, see “ENTER + 0-9: shortcuts for menu commands” on page 147.

- 0: **Memory Status**. For more information, see “Memory Status” on page 624.
- 1: **Exclusive Solo**. For more information, see “Exclusive Solo” on page 147.
- 2: **Rename Song**. For more information, see “Rename Song” on page 624.
- 3: **Initialize Song**. For more information, see “Initialize Song” on page 624.
- 4: **Copy From Song**. For more information, see “Copy From Song” on page 624.
- 5: **Load Template Song**. For more information, see “Load Template Song” on page 624.
- 6: **Save Template Song**. For more information, see “Save Template Song” on page 625.
- 7: **FF/REW Speed**. For more information, see “FF/REW Speed” on page 625.
- 8: **Set Location** (for Locate Key.) For more information, see “Set Location (for Locate Key)” on page 626.
- 9: **GM Initialize**. For more information, see “GM Initialize” on page 626.
- 10: **Copy From Combination**. For more information, see “Copy from Combination” on page 626.
- 11: **Copy From Program**. For more information, see “Copy From Program” on page 626.

## 3-5: Keyboard Zones

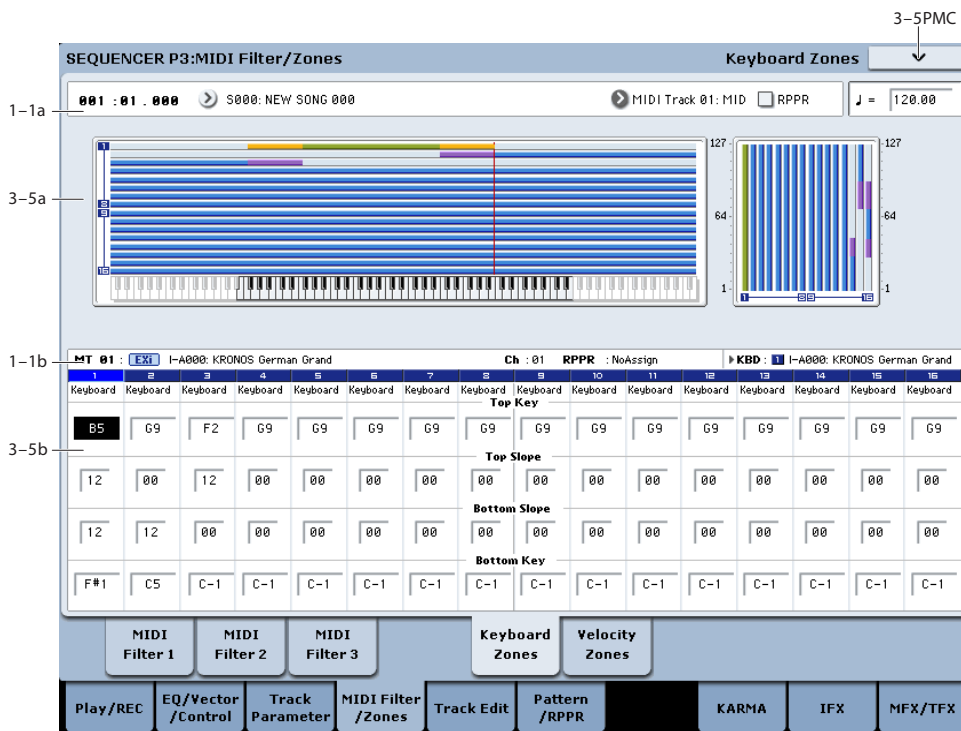

Here you can specify the key zones in which MIDI tracks 1–16 will sound.

The top/bottom key settings specify the zone in which MIDI tracks 1–16 will sound, and the top/bottom slope settings specify the key range over which the volume will change starting from the top/bottom key.

**MIDI** These settings do not affect MIDI transmission/reception. All note data that is received will be recorded into the internal sequencer, and all note data from the internal sequencer or from the keyboard will be transmitted.

### 3-5a: Zone Map

This area indicates the note and velocity ranges in which each MIDI tracks 1–16 will sound.

The LCD screen will display a line to indicate the range of notes and velocities that will sound, and will show the slope portion in different color.

### 3-5b: Keyboard Zones

#### Track 01 (Track Number)

**Top Key** [C-1...G9]

Specifies the top key (upper limit) of the notes that will sound each MIDI track.

**Top Slope** [00, 01, 02, 03, 04, 06, 08, 10, 12, 18, 24, 30, 36, 48, 60, 72]

Specifies the range of keys (12 is one octave) over which the volume will be reached starting from the top key.

**0:** The volume will be at the original level from the top key.

**12:** The volume will increase gradually as you play downward, and will reach the original volume one octave below the top key.

**72:** The volume will increase gradually as you play downward, and will reach the original volume six octaves below the top key.

**Bottom Slope** [00, 01, 02, 03, 04, 06, 08, 10, 12, 18, 24, 30, 36, 48, 60, 72]

Specifies the range of keys (12 is one octave) over which the volume will be reached starting from the bottom key.

**0:** The volume will be at the original level from the bottom key.

**12:** The volume will increase gradually as you play upward, and will reach the original volume one octave above the bottom key.

**72:** The volume will increase gradually as you play upward, and will reach the original volume six octaves above the bottom key.

### Zone Map

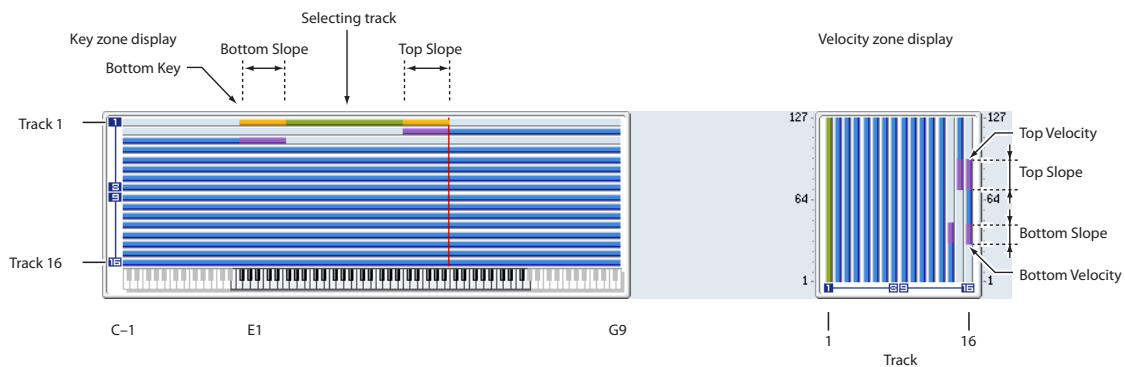

### Bottom Key [C-1...G9]

Specifies the bottom key (lower limit) of the notes that will sound each MIDI track.

How volume will change according to keyboard location

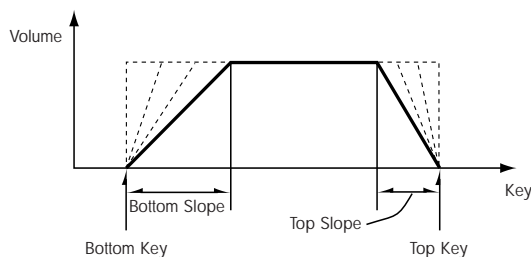

**Top Key** and **Bottom Key** settings can also be input by holding down the ENTER switch and playing a note on the keyboard.

It is not possible to set the bottom key above the top key of the same track. Nor is it possible for the top and bottom slopes to overlap.

### Track 02...16 (Track Number)

These are the key zone settings for MIDI tracks 2 through 16. They are the same as for track 1. See "Track 01":.

### ▼ 3-5: Page Menu Commands

The number before each command shows its ENTER + number-key shortcut. For more information on these shortcuts, see "ENTER + 0-9: shortcuts for menu commands" on page 147.

- **0: Memory Status.** For more information, see "Memory Status" on page 624.
- **1: Exclusive Solo.** For more information, see "Exclusive Solo" on page 147.
- **2: Rename Song.** For more information, see "Rename Song" on page 624.
- **3: Initialize Song.** For more information, see "Initialize Song" on page 624.
- **4: Copy From Song.** For more information, see "Copy From Song" on page 624.
- **5: Load Template Song.** For more information, see "Load Template Song" on page 624.
- **6: Save Template Song.** For more information, see "Save Template Song" on page 625.
- **7: FF/REW Speed.** For more information, see "FF/REW Speed" on page 625.
- **8: Set Location (for Locate Key.)** For more information, see "Set Location (for Locate Key)" on page 626.
- **9: GM Initialize.** For more information, see "GM Initialize" on page 626.
- **10: Copy From Combination.** For more information, see "Copy from Combination" on page 626.
- **11: Copy From Program.** For more information, see "Copy From Program" on page 626.

### 3-6: Velocity Zones

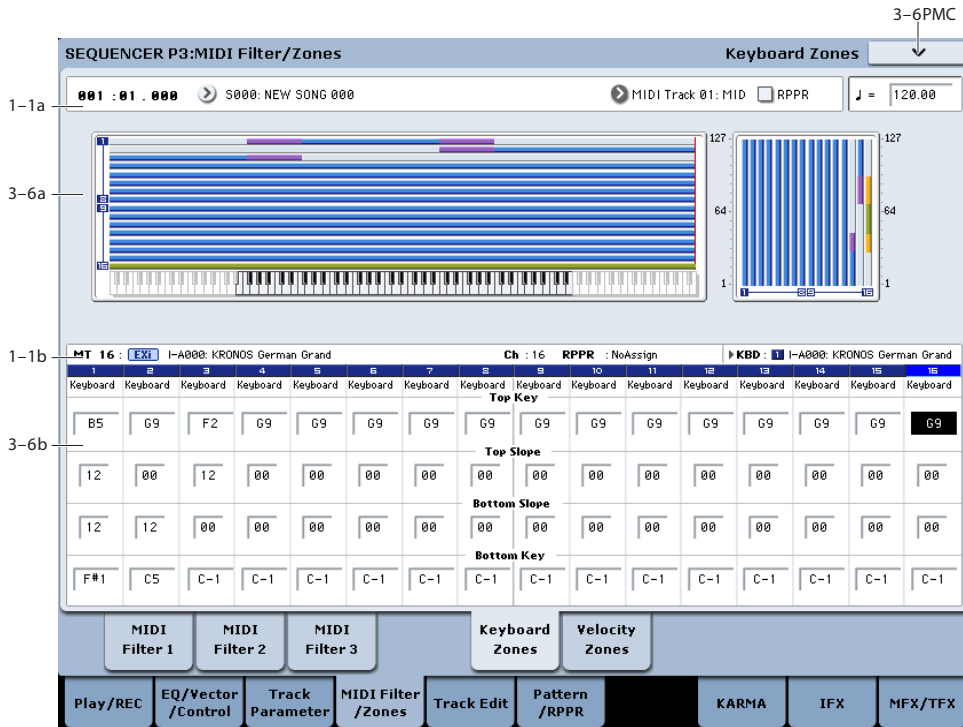

Here you can set the Top/Bottom Velocity parameters to specify the range of velocities that will be sounded by MIDI tracks 1-16, and Top/Bottom Slope specify the range over which the volume will be adjusted.

**MIDI** These settings do not affect MIDI transmission/reception. All note data that is received will be recorded into the internal sequencer, and all note data from the internal sequencer or from the keyboard will be transmitted.

**!** It is not possible to set the bottom velocity greater than the top velocity for the same track. Nor can the top slope and the bottom slope overlap.

#### 3-6a: Zone Map

This area indicates the note and velocity ranges in which each MIDI track will sound. For more information, please see “3-5a: Zone Map” on page 580.

#### 3-6b: Velocity Zones

##### Track 01 (Track Number)

**Top Velocity** [1...127]

Specifies the maximum velocity value that will sound each track.

**Top Slope** [0...120]

Specifies the number of velocity steps over which the original volume will be reached, starting from the Top Velocity.

**0:** The volume will be at the original value from the top velocity.

**120:** The volume will decrease as the velocity approaches the top velocity.

**Bottom Slope** [0...120]

Specifies the number of velocity steps over which the original volume will be reached, starting from the Bottom Velocity.

**0:** The volume will be at the original value from the bottom velocity.

**120:** The volume will decrease as the velocity approaches the bottom velocity.

**Bottom Velocity** [1...127]

Specifies the minimum velocity that will be sounded by each MIDI track 1-16.

How volume will change according to keyboard location

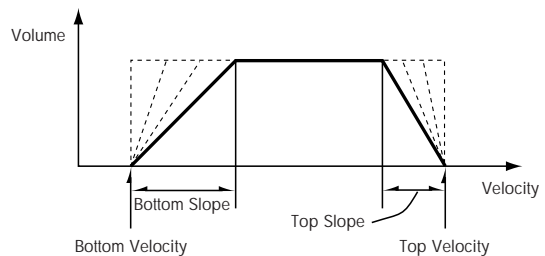

“Top Velocity” and “Bottom Velocity” settings can also be input by holding down the ENTER switch and playing a note on the keyboard.

##### Track 02... 16 (Track Number)

These are the velocity zone settings for MIDI tracks 2 through 16. They are the same as for track 1. See “Track 01”:

---

### ▼ 3–6: Page Menu Commands

The number before each command shows its ENTER + number-key shortcut. For more information on these shortcuts, see “ENTER + 0-9: shortcuts for menu commands” on page 147.

- **0: Memory Status.** For more information, see “Memory Status” on page 624.
- **1: Exclusive Solo.** For more information, see “Exclusive Solo” on page 147.
- **2: Rename Song.** For more information, see “Rename Song” on page 624.
- **3: Initialize Song.** For more information, see “Initialize Song” on page 624.
- **4: Copy From Song.** For more information, see “Copy From Song” on page 624.
- **5: Load Template Song.** For more information, see “Load Template Song” on page 624.
- **6: Save Template Song.** For more information, see “Save Template Song” on page 625.
- **7: FF/REW Speed.** For more information, see “FF/REW Speed” on page 625.
- **8: Set Location** (for Locate Key.) For more information, see “Set Location (for Locate Key)” on page 626.
- **9: GM Initialize.** For more information, see “GM Initialize” on page 626.
- **10: Copy From Combination.** For more information, see “Copy from Combination” on page 626.
- **11: Copy From Program.** For more information, see “Copy From Program” on page 626.

# Sequencer P4: Track Edit

## 4-1: Track Edit

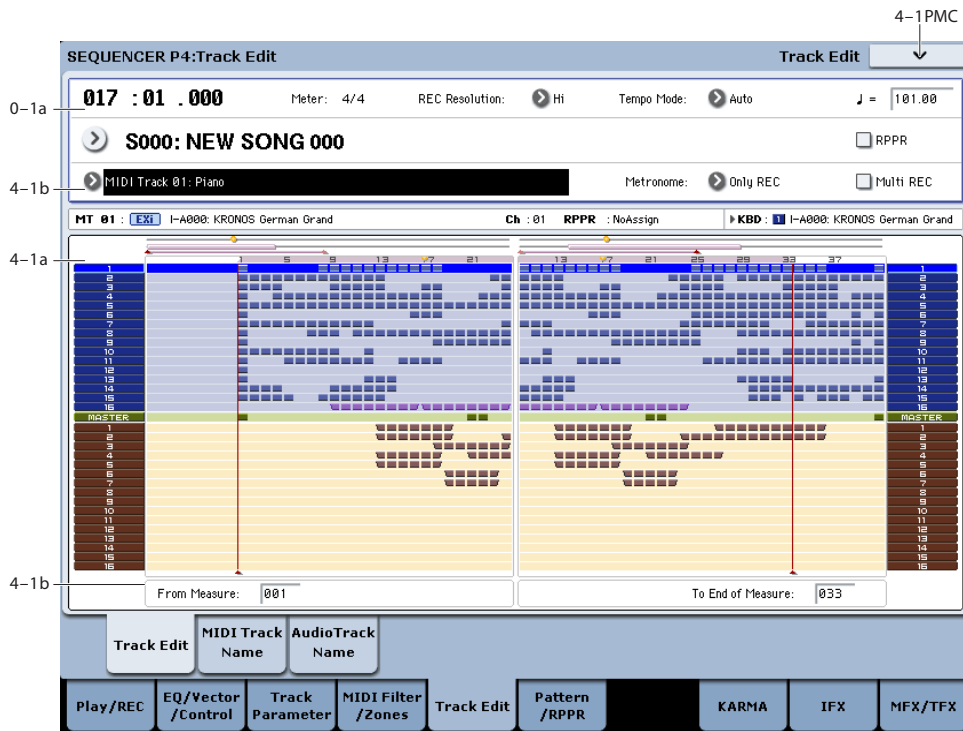

Here you can edit MIDI tracks, the master track, and audio tracks.

When editing a MIDI track, you can move, insert, and delete individual events of note or control change data, or copy, move, insert, and delete measures or tracks. You can also perform Step Recording in this page.

When editing the master track, you can edit the tempo and time signature data.

You can edit audio tracks by moving/inserting/deleting individual data events, or by copying/moving/inserting/deleting specified measures or tracks.

*Note:* To perform track editing (or step editing), use **Track Select** to select the track you want to edit, and use **From Measure** and **To End of Measure** parameters to specify the region that you want to edit. Then choose a command from the page menu, and execute the edit. For details on the specific commands, see “Sequencer: Page Menu Commands” on page 624.

### 4-1a: Track data Map

This area shows the presence or absence of performance data, and indicates the edit range, etc. The currently selected Track will be highlighted.

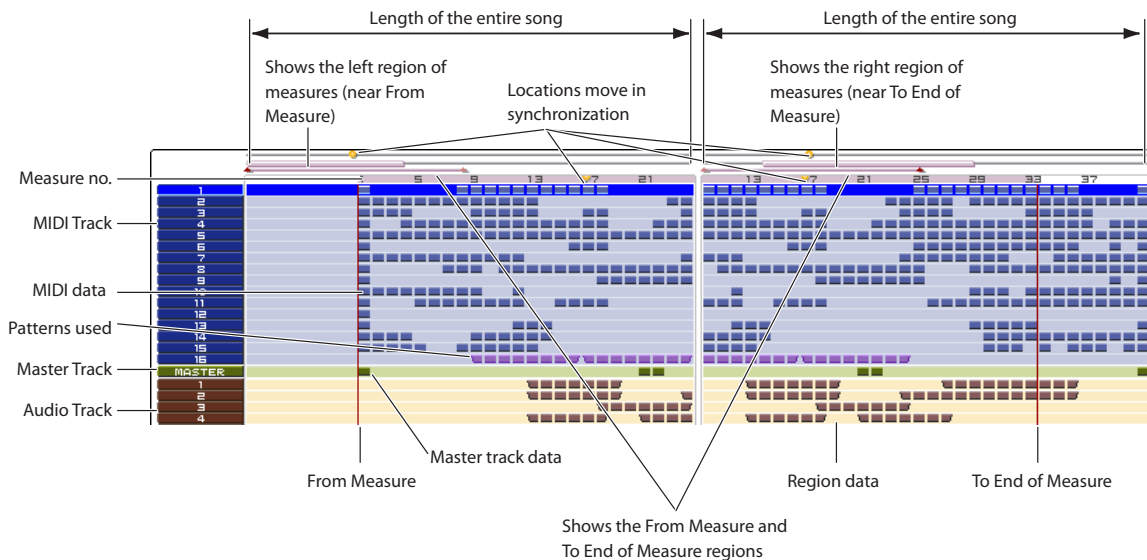

## 4-1b: Track Select, From Measure, To End of Measure

### Track Select[MIDI Track01...MIDI Track16, Master Track, Audio Track01...Audio Track16]

Here you can select the track you want to edit (or use as the copy-source) or record.

If you want to perform an operation on all tracks, you don't need to specify a track here. Simply turn on **All Tracks** in the page menu command dialog box.

**MIDI Track 01...16:** Choose this if you want to edit a MIDI track.

**Master Track:** Choose this if you want to edit the master track.

**Audio Track 01...16:** Choose this if you want to edit an audio track.

If you select an audio track for which stereo pairing is enabled, and execute an edit, the same edit will also be applied to the other audio track of the pair. However, automation edits will affect only one audio track.

*Note:* The available page menu commands will differ depending on whether you select a MIDI Track 01–MIDI Track 16 or Master Track, or an Audio Track 01–Audio Track 16.

**From Measure** [001...999]

**To End of Measure** [001...999]

Specifies the range of measures that you wish to edit (or copy from) or step-record.

Use **From Measure** to specify the starting measure, and **To End of Measure** to specify the ending measure.

## ▼ 4-1: Page Menu Commands

The available commands will be different depending on whether the currently selected Track is MIDI or Audio, as shown below.

The number before each command shows its ENTER + number-key shortcut. For more information on these shortcuts, see "ENTER + 0-9: shortcuts for menu commands" on page 147.

### MIDI Track Edit commands

- 0: **Memory Status.** For more information, see "Memory Status" on page 624.
- 1: **Exclusive Solo.** For more information, see "Exclusive Solo" on page 147.
- 2: **MIDI Step Recording.** For more information, see "MIDI Step Recording" on page 636.
- 3: **MIDI Event Edit.** For more information, see "MIDI Event Edit" on page 637.
- 4: **Set Song Length.** For more information, see "Set Song Length" on page 642.
- 5: **Erase Track.** For more information, see "Erase Track" on page 642.
- 6: **Copy Track.** For more information, see "Copy Track" on page 642.
- 7: **Bounce Track.** For more information, see "Bounce Track" on page 643.

- 8: **Erase Measure.** For more information, see "Erase Measure" on page 643.
- 9: **Delete Measure.** For more information, see "Delete Measure" on page 644.
- 10: **Insert Measure.** For more information, see "Insert Measure" on page 645.
- 11: **Repeat Measure.** For more information, see "Repeat Measure" on page 646.
- 12: **Copy Measure.** For more information, see "Copy Measure" on page 646.
- 13: **Move Measure.** For more information, see "Move Measure" on page 647.
- 14: **Create Control Data.** For more information, see "Create Control Data" on page 647.
- 15: **Erase Control Data.** For more information, see "Erase Control Data" on page 648.
- 16: **Quantize.** For more information, see "Quantize" on page 648.
- 17: **Shift/Erase Note.** For more information, see "Shift/Erase Note" on page 649.
- 18: **Modify Velocity.** For more information, see "Modify Velocity" on page 650.
- 19: **FF/REW Speed.** For more information, see "FF/REW Speed" on page 625.
- 20: **Set Location** (for Locate Key.) For more information, see "Set Location (for Locate Key)" on page 626.

### Audio Track Edit commands

- 0: **Memory Status.** For more information, see "Memory Status" on page 624.
- 1: **Exclusive Solo.** For more information, see "Exclusive Solo" on page 147.
- 2: **Audio Event Edit.** For more information, see "Audio Event Edit" on page 638.
- 3: **Audio Automation Edit.** For more information, see "Audio Automation Edit" on page 641.
- 4: **Set Song Length.** For more information, see "Set Song Length" on page 642.
- 5: **Erase Track.** For more information, see "Erase Track" on page 642.
- 6: **Copy Track.** For more information, see "Copy Track" on page 642.
- 7: -----
- 8: **Erase Measure.** For more information, see "Erase Measure" on page 643.
- 9: **Delete Measure.** For more information, see "Delete Measure" on page 644.
- 10: **Insert Measure.** For more information, see "Insert Measure" on page 645.
- 11: **Repeat Measure.** For more information, see "Repeat Measure" on page 646.
- 12: **Copy Measure.** For more information, see "Copy Measure" on page 646.
- 13: **Move Measure.** For more information, see "Move Measure" on page 647.



- 14: **Region Edit.** For more information, see “Region Edit” on page 651.
- 15: **Volume Ramp.** For more information, see “Volume Ramp” on page 653.
- 16: **Copy Song’s Tempo to Region.** For more information, see “Copy Song’s Tempo to Region” on page 653.
- 17: **Adjust Song’s Tempo to Region.** For more information, see “Adjust Song’s Tempo to Region” on page 653.
- 18: **Adjust Region to Song’s Tempo.** For more information, see “Adjust Region to Song’s Tempo” on page 654.
- 19: **FF/REW Speed.** For more information, see “FF/REW Speed” on page 625
- 20: **Set Location** (for Locate Key.) For more information, see “Set Location (for Locate Key)” on page 626.

## 4–2: MIDI Track Name

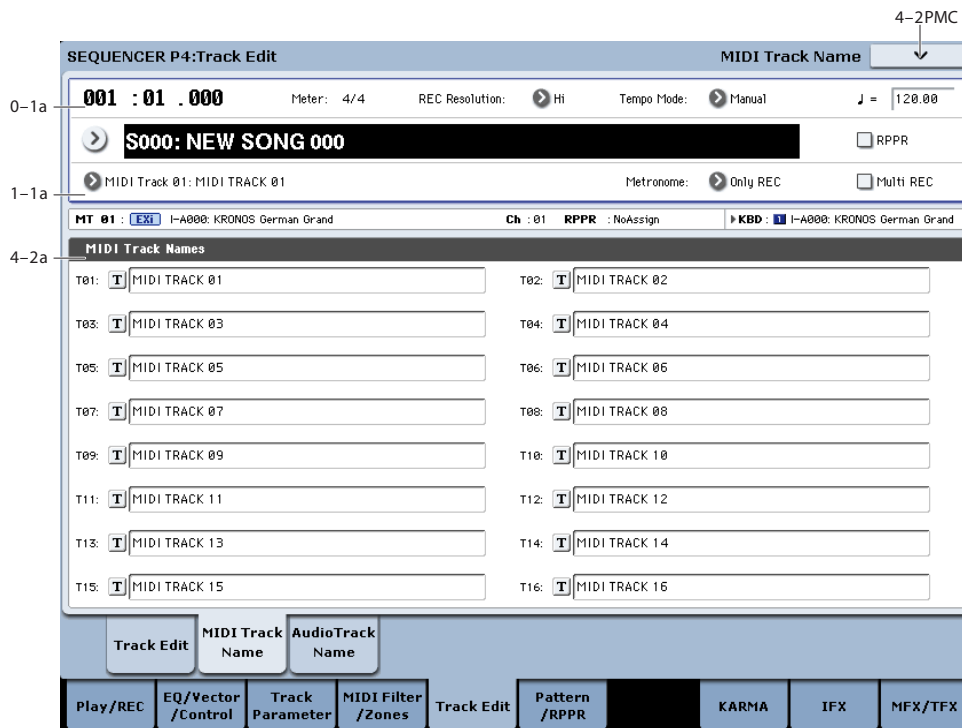

Here you can assign a name to each track.

### 4–2a: MIDI Track Names

**T01...T16** [MIDI Track Name]

Here you can rename the MIDI tracks.

Press the text edit button to open the dialog box, and input the desired characters. You can enter up to 24 characters. For more information, see “Editing names” on page 184 of the Operation Guide.

### ▼ 4–2: Page Menu Commands

The available commands will be different depending on whether the currently selected Track is MIDI or Audio.

The commands are exactly the same as for the main Track Edit page; for more information, see “MIDI Track Edit commands” on page 585, and “Audio Track Edit commands” on page 585.

## 4-3: AUDIO Track Name

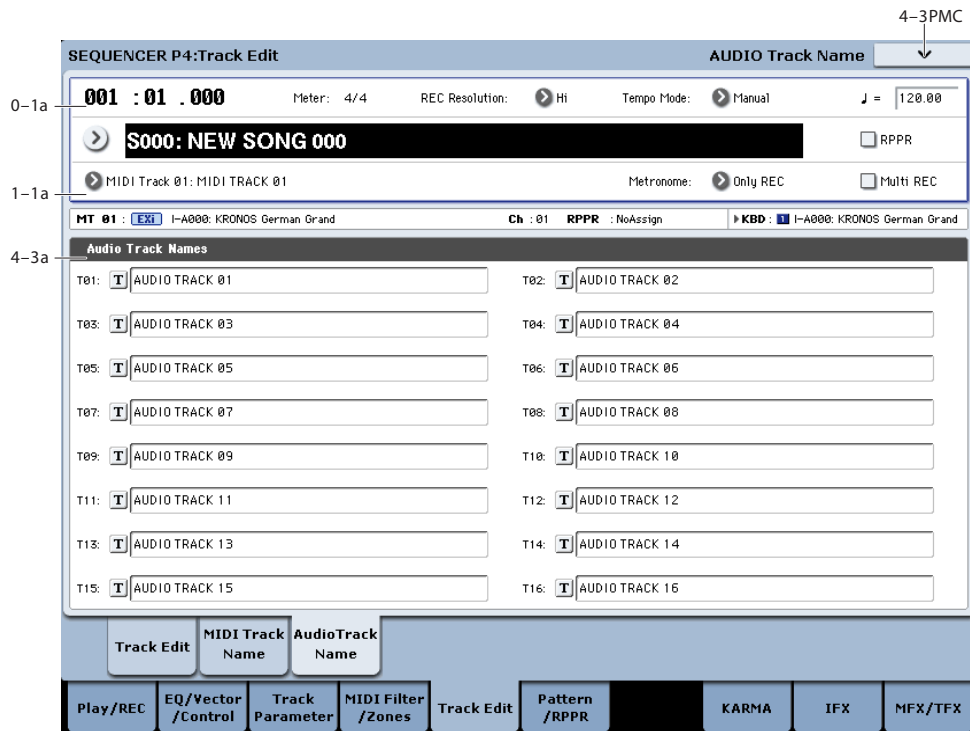

Here you can assign a name to each audio track.

### 4-3a: Audio Track Names

#### T01...T16 [Audio Track Name]

Here you can rename the audio tracks.

Press the text edit button to open the dialog box, and input the desired characters. You can input up to 24 characters. For more information, see “Editing names” on page 184 of the Operation Guide.

### ▼ 4-3: Page Menu Commands

The available commands will be different depending on whether the currently selected Track is MIDI or Audio.

The commands are exactly the same as for the main Track Edit page; for more information, see “MIDI Track Edit commands” on page 585, and “Audio Track Edit commands” on page 585.

## Sequencer P5: Pattern/RPPR

On the KRONOS you can use preset patterns P00–155, and user patterns U00–99.

Preset patterns provide patterns that are suitable for drum tracks, and can be selected from any song.

One hundred user patterns are provided for each song; you can create and store your own patterns in these.

Normally, you will create a track of performance data by using the “Put To MIDI Track” or “Copy To MIDI Track” page menu commands to place patterns consisting of several measures into a track. You can also use the RPPR function, which lets you trigger patterns assigned to each key simply by pressing the desired key, and realtime-record the patterns that play back. (See the RPPR Setup page.)

### 5–1: Pattern Edit

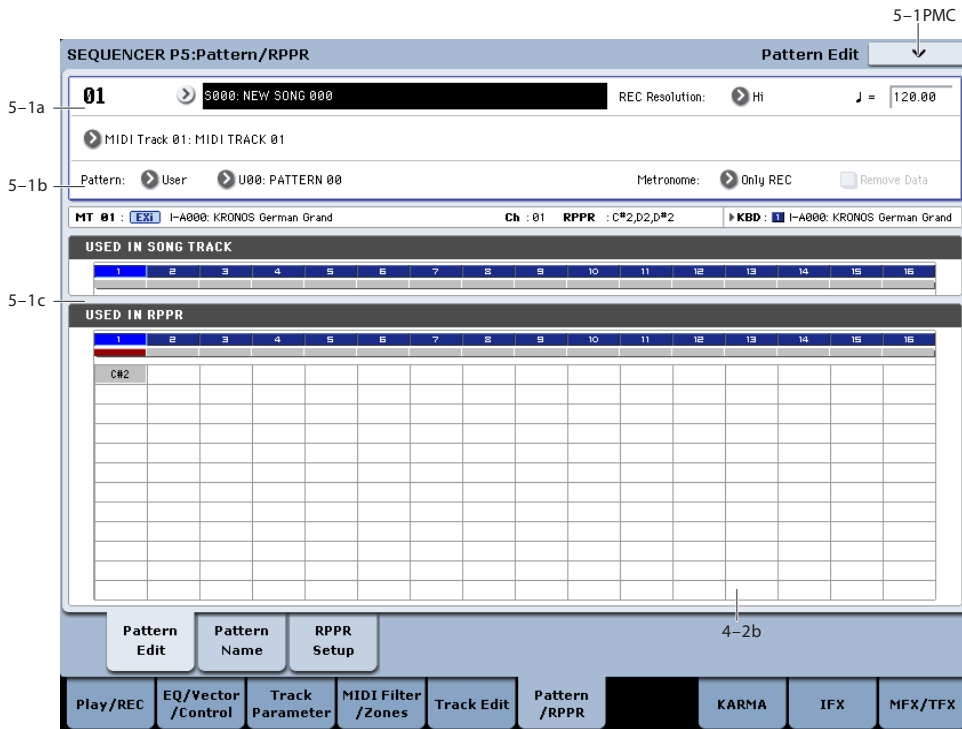

Here you can record and edit patterns, and assign them to tracks of a song. The following types of pattern operations are available.

User patterns can be recorded in real-time (as well as recorded from performances generated by KARMA), step-recorded, or created using the Get From MIDI Track command or Copy Pattern command. You can also copy a preset pattern to a user pattern and edit it. (You can't directly edit a preset pattern.)

Preset patterns and user patterns can be placed in or copied into a track.

User patterns can also be converted into Drum Track Patterns, which can then be used in the Drum Track in Programs and Combinations, as well as Songs. For more information, see “Convert to Drum Track Pattern” on page 657.

#### 5–1a: Location, Resolution, Tempo, Song/Track Select

##### Location [01...99]

Displays the current measure location of the selected pattern.

##### Song Select [000...199: name]

Selects a song.

The user pattern will be created in the song you select.

##### Resolution [Hi, 1/3, 1/2, 2/3, 1, 2, 3, 4]

Specifies how the timing of the data being recorded into the pattern will be corrected. For details, see “REC Resolution (Realtime REC Quantize Resolution)” on page 514.

##### Tempo (Tempo) [040.00...300.00, EXT]

Specifies the playback tempo of the pattern. For details, see “Tempo” on page 514.

##### Track Select [MIDI Track01...MIDI Track16, Master Track, Audio Track01...Audio Track16]

Selects the track that will be used to record/play the pattern data. The pattern data will be recorded/played using the settings of the track you select. The area at the right displays the program bank, number, and name for the selected track.

Settings of Master Track, Audio Track 01–16 will be ignored. The most recently selected MIDI Track 01–16 will be used.

## 5-1b: Pattern, Pattern Select, Metronome, Remove Data

### How to record a user pattern

1. Use "Song Select" to select the song in which you want to create a user pattern.

2. Use Track Select to select the sound that you will record.

The pattern you record will sound according to your choice in Track Select.

3. Use Pattern Bank and Pattern Select to select User pattern and the desired pattern number.

4. Select the page menu command "Pattern Parameter," and in the dialog box, specify the number of measures and time signature of the pattern.

5. Check the tempo in "♪".

6. If you want to record in realtime, set "Resolution" to specify the resolution, and press the SEQUENCER REC/WRITE switch and then the START/STOP switch to begin recording.

When you finish recording to the end of the measures specified by "Pattern Parameter," you will return to the first measure, and can continue recording while adding more material. For details, see "Loop All Tracks" on page 526.

If you want to perform step recording, select the page menu command "Step Recording (Loop Type)" to open the dialog box, and record. For the procedure of step recording, see "MIDI Step Recording" on page 636 and "Step Recording (Loop Type)" on page 654.

7. After recording, use the page menu commands as desired to edit the pattern or the events in the pattern.

### Pattern (Pattern Bank) [Preset, User]

Selects the type of pattern.

If Preset is selected, it will not be possible to record. You will be able to select and execute the "Copy Pattern," "Bounce Pattern," "Put To MIDI Track," and "Copy To MIDI Track" page menu commands.

### Pattern Select [P000...697, U00...U99]

Selects a pattern. User patterns can be renamed in the P5- Pattern Name page.

### Metronome [Only REC, REC & Play, Off]

Specifies whether the metronome will sound during recording or playback. For details, see "0-5d: Metronome Setup" on page 528.

### Remove Data [Off, On]

**On (checked):** Unwanted performance data can be removed during pattern recording. The procedure is the same as explained in "Remove Data" of Loop All Tracks. For details, see "Remove Data" on page 526.

## 5-1c: USED IN SONG TRACK, USED IN RPPR

### USED IN SONG TRACK

This area indicates the pattern usage status for the patterns selected for the track.

### USED IN RPPR

This area indicates the RPPR in which the selected pattern is used. The assigned key and the specified track are shown.

## ▼ 5-1: Page Menu Commands

The number before each command shows its ENTER + number-key shortcut. For more information on these shortcuts, see "ENTER + 0-9: shortcuts for menu commands" on page 147.

- 0: **Memory Status.** For more information, see "Memory Status" on page 624.
- 1: **Exclusive Solo.** For more information, see "Exclusive Solo" on page 147.
- 2: **Step Recording (Loop Type).** For more information, see "Step Recording (Loop Type)" on page 654.
- 3: **Event Edit.** For more information, see "Event Edit" on page 654.
- 4: **Pattern Parameter.** For more information, see "Pattern Parameter" on page 655.
- 5: **Erase Pattern.** For more information, see "Erase Pattern" on page 655.
- 6: **Copy Pattern.** For more information, see "Copy Pattern" on page 655.
- 7: **Bounce Pattern.** For more information, see "Bounce Pattern" on page 655.
- 8: **Get From MIDI Track.** For more information, see "Get From MIDI Track" on page 656.
- 9: **Put To MIDI Track.** For more information, see "Put To MIDI Track" on page 656.
- 10: **Copy To MIDI Track.** For more information, see "Copy To MIDI Track" on page 656.
- 11: **FF/REW Speed.** For more information, see "FF/REW Speed" on page 625.

## 5-2: Pattern Name

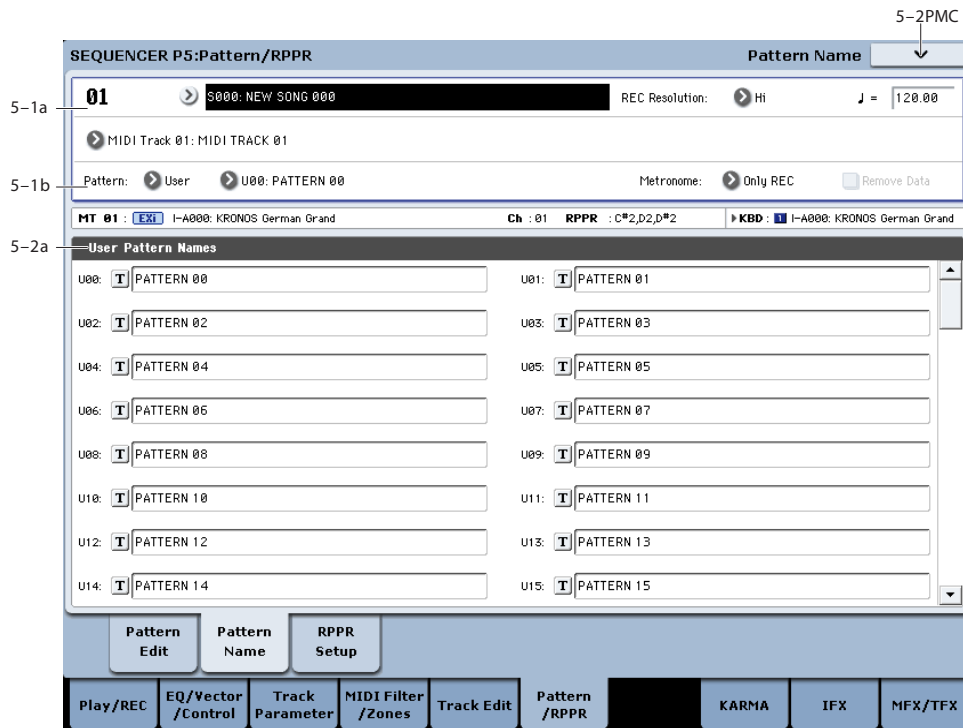

### 5-2a: User Pattern Names

#### Pattern name [U00...U99]

Here you can rename the pattern. Press the text edit button to open the dialog box, and input the name. You can enter up to 24 characters. For more information, see "Editing names" on page 184 of the Operation Guide.

- **8: Get From MIDI Track.** For more information, see "Get From MIDI Track" on page 656.
- **9: Put To MIDI Track.** For more information, see "Put To MIDI Track" on page 656.
- **10: Copy To MIDI Track.** For more information, see "Copy To MIDI Track" on page 656.
- **11: FF/REW Speed.** For more information, see "FF/REW Speed" on page 625.

### ▼ 5-2: Page Menu Commands

The number before each command shows its ENTER + number-key shortcut. For more information on these shortcuts, see "ENTER + 0-9: shortcuts for menu commands" on page 147.

- **0: Memory Status.** For more information, see "Memory Status" on page 624.
- **1: Exclusive Solo.** For more information, see "Exclusive Solo" on page 147.
- **2: Step Recording (Loop Type).** For more information, see "Step Recording (Loop Type)" on page 654.
- **3: Event Edit.** For more information, see "Event Edit" on page 654.
- **4: Pattern Parameter.** For more information, see "Pattern Parameter" on page 655.
- **5: Erase Pattern.** For more information, see "Erase Pattern" on page 655.
- **6: Copy Pattern.** For more information, see "Copy Pattern" on page 655.
- **7: Bounce Pattern.** For more information, see "Bounce Pattern" on page 655.

## 5-3: RPPR Setup

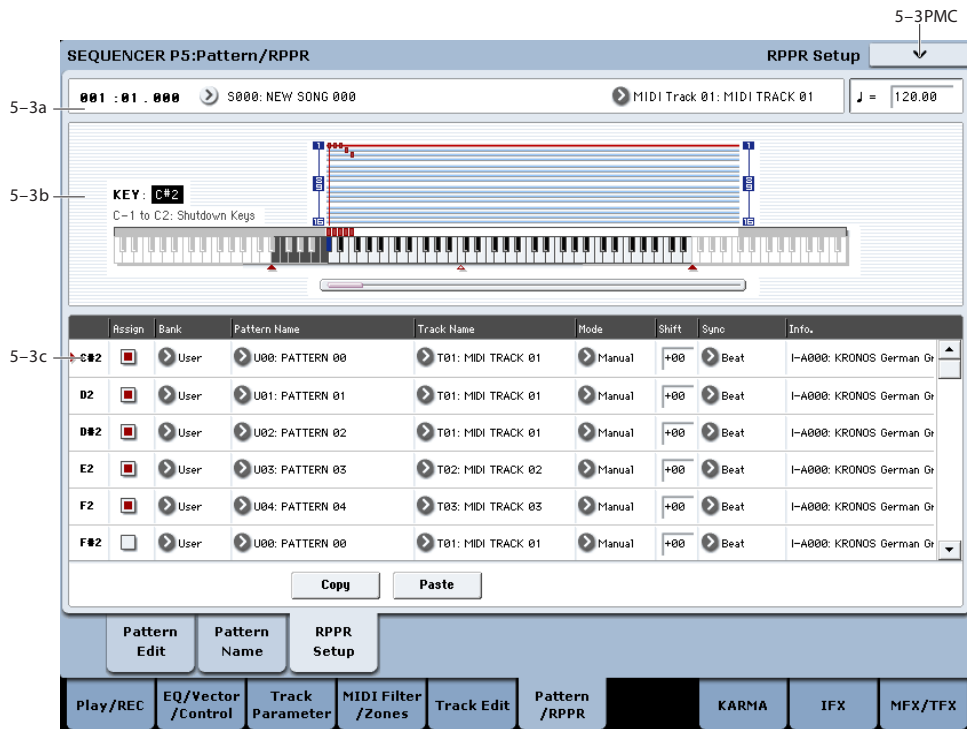

Here you can make settings for the RPPR (Realtime Pattern Play/Recording) function. RPPR lets you assign patterns to individual keys, and then playback patterns simply by pressing individual notes on the keyboard. This performance can be recorded in real-time.

For each song, you can assign either a preset pattern or a user pattern to each of the 72 keys in the range C#2–C8. For each key, you can specify the pattern, track number, and how the pattern will be played.

**⚠** Keys used to play patterns via RPPR cannot be used for KARMA. If RPPR is on, keys to which a pattern is not assigned will play the program of the track that's selected in **Track Select**. In this case, KARMA will operate if KARMA Module A, B, C, or D is assigned to the track and turned on. Also, notes generated by KARMA will not trigger the RPPR function.

**MIDI** When Local Control is OFF ("Local Control On" Global 1-1a), the keyboard will not trigger RPPR pattern playback. Notes received at MIDI IN on the channel of the track currently selected by **Track Select** will trigger patterns. If you have recorded only the trigger notes on an external sequencer and wish to use the playback from the external sequencer to trigger RPPR patterns on KRONOS, set Local Control OFF.

If you want the note data generated by RPPR to be recorded by the external sequencer, set Local Control ON, and turn off the echo back function of the external sequencer. See "Local Control On settings" on page 1128.

**⚠** In the RPPR Setup page, RPPR is turned on automatically. This will be the same result as when the RPPR check box (0-1a) in each page is checked.

### 5-3a: Song Select, Track Select, Tempo

#### Song Select [00...199: name]

Selects the desired song. The RPPR settings will be assigned to the song you select here.

#### Track Select [MIDI Track01...MIDI Track16, Master Track, Audio Track01...Audio Track16]

When you play a key that is not assigned to RPPR, it will sound using the settings of the track that's selected in **Track Select**. Use this to select the track that you want to play together with RPPR, or to audition a pattern before you assign it. The program bank, number, and name of the selected track is shown at the right.

Each RPPR pattern will begin playing when you press the assigned key, regardless of the **Track Select** setting. It will sound using the settings of the track selected in "Track Name."

**⚠** The Master Track and Audio Track 01-16 settings are ignored. The last-selected MIDI Track 01-16 will be used.

#### ♩ (Tempo) [040.00...300.00, EXT]

Specifies the playback tempo of the patterns. (0-1a)

### 5-3b: KEY, Keyboard & Assigned graphics

#### KEY (Key Select) [C#2...C8]

Specifies the key to which you want to assign an RPPR pattern.

The following parameters will apply to the key that you select here.

This can also be selected by holding down the ENTER switch and playing a note on the keyboard.

**Keyboard & Assigned graphics**

This shows the selected key, and the keys to which a pattern has been assigned by the RPPR function. See diagram below.

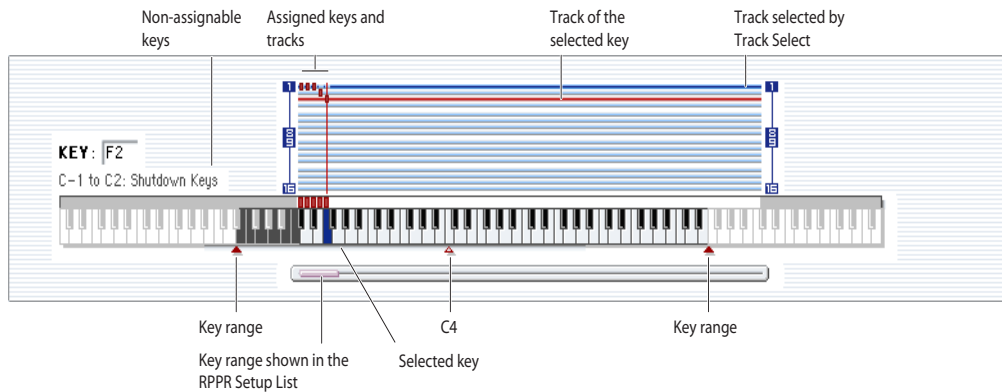

**5-3c: RPPR Setup**

**Note** [C#2...C8]

**Assign** [Off, On]

**On (checked):** When you playback the key specified by "KEY," the pattern selected in **Pattern** will be triggered.

**Off (unchecked):** That key will sound the currently selected track at the corresponding pitch, just as in normal Sequencer mode.

**Pattern Bank** [Preset, User]

**Pattern** [P000...697, U00...99]

Selects the RPPR pattern for the key selected in "KEY." If the selected user pattern contains no musical data, there will be no sound when you press that key.

**Track** [MIDI Track 01...MIDI Track16]

Selects the track that will be used for the RPPR pattern selected for the "KEY." When you play the key, the pattern will be played according to the settings of the track you select here. You can make track settings in the P0: Play/REC-P3: MIDI Filter pages.

When you record in realtime with the RPPN function turned on, the data will be recorded on the track you select here. For details, see "Using RPPR (Realtime Pattern Play/Record)" on page 106.

"Information" shows the bank, name, and number of the program that's selected for **Track**.

**Mode** [Once, Manual, Endless]

Specifies the way in which the pattern assigned to the specified "KEY" will be played.

**Once:** When you press the key, the complete pattern will playback once to the end and then stop.

**Manual:** The pattern will continue repeating as long as you continue holding the key, and will stop as soon as you release the key.

**Endless:** The pattern will continue repeating even after you release the key. To stop the pattern playback, press any note below C2, or press the same key once again.

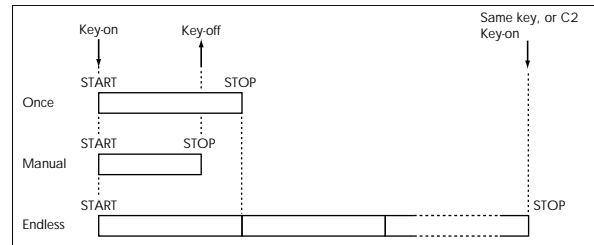

**Shift** [-12...+12]

Adjusts the playback pitch of the pattern for the specified "KEY" in semitone steps over a range of ±1 octave.

With a setting of 0, the pattern will be played at its original pitch.

**Sync** [Off, Beat, Measure, SEQ]

Specifies the way in which the pattern playback will be synchronized when you press the specified "KEY."

**Off:** The pattern will begin playing at the moment you press the note.

**Beat:** The pattern will synchronize to the beats of the pattern that was started by the first key (i.e., the first note-on that occurs from a condition where no notes of the keyboard are pressed). This setting is suitable when you wish to play phrase patterns in unison.

**Measure:** The pattern will synchronize to the measures of the pattern that was started by the first key. This setting is suitable for rhythm, bass or drum patterns.

**SEQ:** The pattern will synchronize to the measures of the sequencer song.



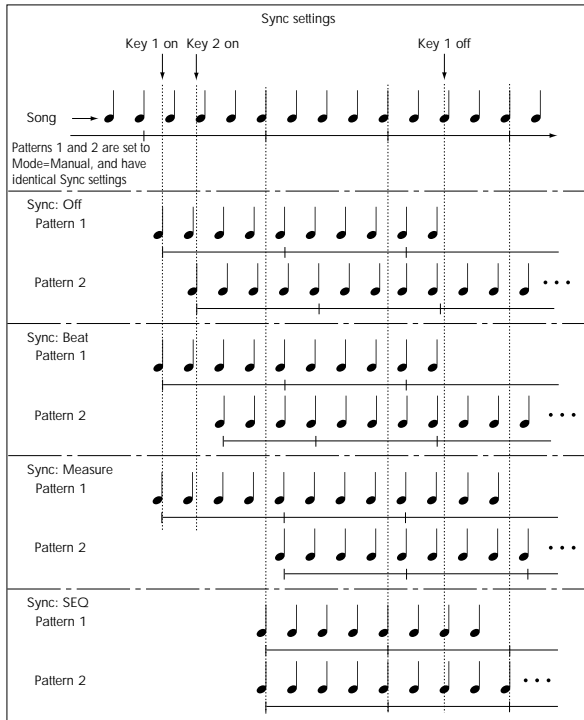

- When Beat or Measure are selected, pattern playback will begin when you press the first key. The second and subsequent patterns that are triggered from the keyboard will synchronize to the pattern that was started by the first key; with a setting of Beat they will synchronize in steps of a beat, and with a setting of Measure they will synchronize in steps of a measure.
- When SEQ is selected, the pattern will playback in synchronization with the measures of the sequencer song. The pattern will synchronize with the currently-playing song, so you must start the song before you play notes on the keyboard.
- Beat, Measure, and SEQ will cause the pattern to start immediately if you play the key within a thirty-second note of the timing of the respective beat or measure, but if you play the key later than this, the start of the pattern will be delayed by a beat.

**Information**

This area shows the bank, name, and number of the program that's selected for the track.

**Stopping playback of a RPPR pattern**

By pressing C2 (or any note lower than C2), all the patterns being played by RPPR will stop.

The patterns of keys whose "Sync" setting is Off will stop immediately, but the playback of other keys will stop at the beginning of the next beat or measure. Pattern playback of keys whose "Sync" setting is other than On can be stopped immediately by rapidly pressing C2 or any lower note twice in succession.

**Copy**

This copies the **Assign, Pattern Bank, Pattern, Track, Mode, Shift,** and **Sync** settings of the selected "KEY" into a copy buffer.

**Paste**

This pastes the settings from the copy buffer (obtained by "Copy") into the "KEY" of the selected parameter.

**Example): Assigning preset patterns P00, P01, and P02 to "KEY"**

Before you begin, assign a drum program such as MIDI track 1.

1. **Check C#2 "Assign." Set Pattern Bank to Preset, set Pattern to P00, and set Track to MIDI Track 01.**

With the C#2 parameter selected, press "Copy."

Assign	Bank	Pattern Name	Track Name
C#2	Preset	P001: Pop & Ballad 1 [Std]	T01: MIDI TRACK 01
D2	User	U00: PATTERN 00	T01: MIDI TRACK 01
D#2	User	U00: PATTERN 00	T01: MIDI TRACK 01
E2	User	U00: PATTERN 00	T02: MIDI TRACK 02
F2	User	U00: PATTERN 00	T03: MIDI TRACK 03
F#2	User	U00: PATTERN 00	T01: MIDI TRACK 01

Copy Paste

2. **Select the D2 parameter, and press the Paste button.**

The **Assign, Pattern Bank, Pattern, Track, Mode, Shift,** and **Sync** settings you made in step 1 will be copied automatically.

3. **Change just the Pattern. Select Pattern, and press the Δ switch to select P01.**

4. **Select a D#2 parameter and press the Paste button.**

The **Assign, Pattern Bank, Pattern, Track, Mode, Shift,** and **Sync** settings you made in step 1 will be copied automatically.

As you did in step 3, set **Pattern** to P02.

By using **Copy** and **Paste** in this way, you can efficiently specify **Pattern (Pattern Bank), Pattern,** and **Track** settings for each "KEY" when creating RPPR data. This is particularly convenient when, as in the above example, the patterns that you want to assign to the keys are numbered consecutively (or are nearby each other), and use the same track.

**▼ 5-3: Page Menu Commands**

The number before each command shows its ENTER + number-key shortcut. For more information on these shortcuts, see "ENTER + 0-9: shortcuts for menu commands" on page 147.

- 0: **Memory Status.** For more information, see "Memory Status" on page 624.
- 1: **Exclusive Solo.** For more information, see "Exclusive Solo" on page 147.

## Sequencer P7: KARMA

Here you can make settings for KARMA used in Sequencer mode. Songs can use four KARMA Modules: A, B, C, and D).

In Sequencer mode, you can use KARMA on song tracks or for pattern real-time recording. The note-on/off and MIDI control data generated by the KARMA Modules can be recorded as events on a track or pattern. You can use the KARMA SCENES switches 1-8, KARMA SLIDERS 1-8 and KARMA SWITCHES 1-8.

When playing back a song or pattern, you can use KARMA in real-time on your keyboard playing, or in conjunction with real-time performance using the RPPR function

- ⚠ The data from the internal sequencer is not input to the KARMA Modules. Note data from the internal sequencer cannot be used as triggers to cause KARMA to generate phrases.

The state of the KARMA ON/OFF switch, KARMA SLIDERS 1-8, KARMA SWITCHES 1-8, LATCH and SCENES 1-8 switches, and the note settings/velocity of the Pad 1-8 can be saved independently for each song.

By using the page menu command “Copy KARMA Module,” you can easily copy the KARMA Module settings of a program or combination. Use this when you wish to use Sequencer mode to record the KARMA phrase or pattern of Program mode.

By using the page menu command “Copy From Combination,” you can copy the entire settings of a combination, and real-time record a performance that uses KARMA (Multi REC).

By using the function (see “Tip:” on page 512) you can automatically transfer the settings of a program or combination into a song, and then begin recording immediately simply by pressing the START/STOP switch. If you come up with an inspired phrase or song idea while using KARMA in Program or Combi Mode, you can immediately convert your inspiration into a song. The function seamlessly takes you from playing a program or combination into creating a song.

- ⚠ The tempo of the song and KARMA cannot be set independently.

If **MIDI Clock** (Global 1-1b) is set to Internal, you can use the start timing of the internal sequencer to synchronize the KARMA Module.

- If you press the START/STOP switch while KARMA is operating, KARMA will synchronize to the timing of the sequencer.
- If you then press the START/STOP switch again, KARMA will stop playing, as will the sequencer. If you wish to stop only KARMA, press the KARMA ON/OFF switch.

- ⚠ When **MIDI Clock** (Global 1-1a) is set to External, KARMA will play only when MIDI Clock messages are being received, and stop playing when the Clock messages stop. For more information, see “Synchronizing KARMA” on page 235 of the Operation Guide.

## 7-1: GE Setup/Key Zones

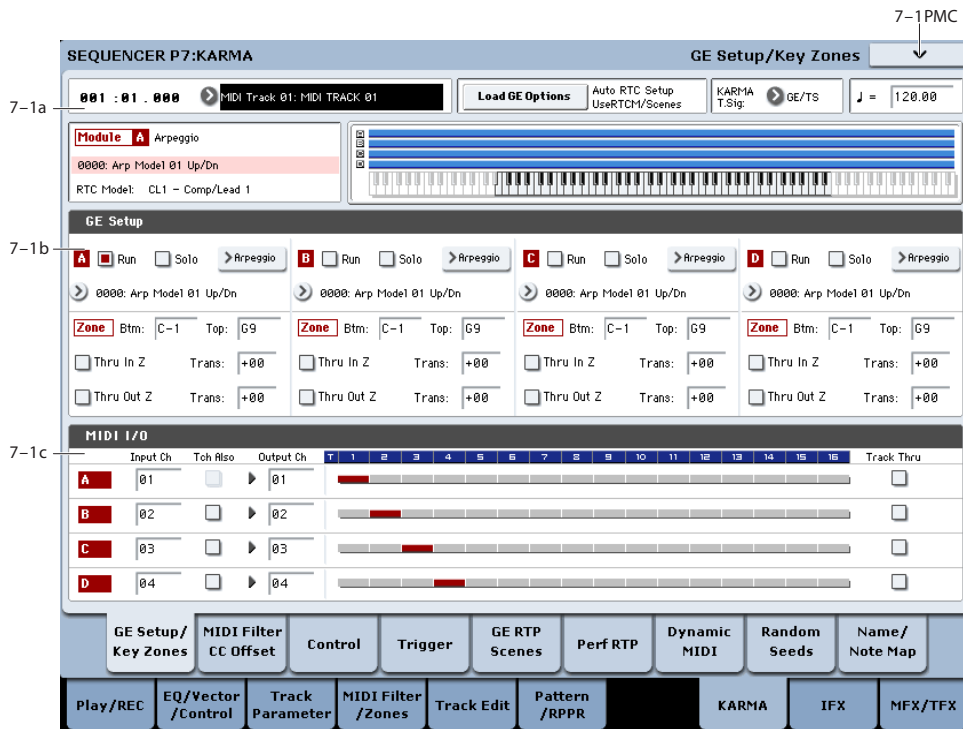

Here you can select the GE that will be used by each KARMA Module, and specify the Key Zone and MIDI Setup for the four KARMA Modules used by the Sequencer mode song.

### 7-1a: Location, Track Select, Load GE Options, KARMA T.Sig, Tempo

**Location** [001:01.000...999:16.191]

**Track Select** [MIDI Track01...MIDI Track16, Master Track, Audio Track01...Audio Track16]

**Tempo** [040.00...300.00, EXT]

These parameters let you select the current Track, set the location of the sequence, and control the tempo. For more information, see "0-1a: Location, Song/Track Select" on page 513.

**Load GE Options** [Dialogue]

These options let you specify whether the values and assignments for the KARMA SLIDERS and SWITCHES will be set automatically, be initialized, or be preserved when you select a GE. For more information, see "Load GE Options" on page 9.

**KARMA T. Sig (KARMA Time Signature)** [GE/TS, 1/4...16/4, 1/8...16/8, 1/16...16/16]

For more information, see "KARMA T.Sig (Time Signature)" on page 10.

### Selected KARMA Module Info

#### GE Number & Name

**RTC Model** [List of RTC Models]

This displays information for the KARMA Module specified by the Module Control Setting.

For more information, see "Selected KARMA Module Info" on page 423.

#### Module Zone Display

The key zone settings of each of the four KARMA Modules are displayed as a solid blue line.

For more information, see "Module Zone Display" on page 109.

### 7-1b: GE Setup

#### GE

**Run** [Off, On]

**Solo** [Off, On]

**GE Select** [Preset 0000...2047, USER-A...L 000...127]

For more information, please see "0-6b: GE Select" on page 422.

**GE Bank Select** [Preset...USER-L]

**GE Category Select** [Arpeggio...Real-Time]

#### Key Zones

Specify the range of note data (the key zone) that will control each KARMA Module.

**Btm (Key Zone Bottom)** [C-1...G9]

**Top (Key Zone Top)** [C-1...G9]

Please see “Key Zones” on page 471.

*Note:* In Sequencer mode, MIDI data for each KARMA Module is transmitted and received on the “Input Channel” and “Output Channel” (7-1c) that you specify for each Module.

**Transpose**

**Thru In Z (Thru In Zone)** [Off, On]

**Trans (Transpose In Zone)** [-36...+36]

**Thru Out Z (Thru Out Zone)** [Off, On]

**Trans (Transpose Out Zone)** [-36...+36]

Please see “Key Zones” on page 471.

**7-1c: MIDI I/O**

Specifies the MIDI input/output channels for the four KARMA Modules used by a Sequencer mode song.

*Note:* These settings make it possible to use multiple KARMA Modules, and simultaneously play multiple tracks of different MIDI channels. If you wish to real-time record such a performance, use multi-track recording setup (Sequencer 0-1a: Multi REC).

**Input Channel** [01...16, Tch]

Specifies the MIDI input channel for each KARMA Module.

MIDI data from the keyboard or from MIDI IN that matches the specified MIDI channel will be input to the KARMA Module. (See the diagram below, “KARMA-MIDI Input/Output Channel.”)

**Tch:** Automatically match the MIDI channel (Sequencer 2-1a) of the track selected by **Track Select** (Sequencer 0-1a).

KARMA - MIDI Input / Output Channel

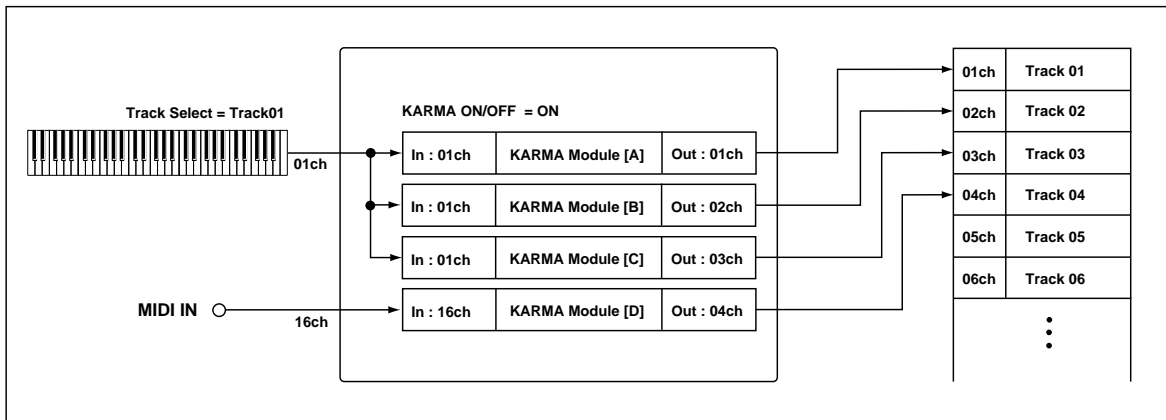

**Tch Also** [Off, On]

This specifies whether the MIDI channel of the MIDI track selected in **Track Select** will be used for MIDI input in addition to the MIDI channel specified by “Input Channel.”

**Off (unchecked):** Only the MIDI channel specified by “Input Channel” will be used as the MIDI input channel for the KARMA Module.

**On (checked):** The MIDI channel specified by “Input Channel” and the MIDI channel of the MIDI track selected by **Track Select** will be used as the MIDI input channels for the KARMA Module.

If you check “Tch Also,” you will also be able to control KARMA from the keyboard (transmitted on the MIDI channel of the MIDI track selected by **Track Select**).

*Note:* If you’ve selected Master Track or Audio Track for **Track Select**, the MIDI channel of the MIDI track shown in “Selected Track Info:” will be used.

⚠ Not available if the Module’s “Input Channel” is Tch or the same MIDI channel as the MIDI track selected for **Track Select**.

**Output Channel** [01...16, Tch]

Specifies the MIDI output channel for each KARMA Module.

The MIDI data from each KARMA Module will be transmitted on the MIDI output channel specified for that KARMA Module, and will be sounded by tracks with matching channels. For real-time recording, data will be recorded on tracks with matching channels. (See the diagram below, “KARMA-MIDI Input/Output Channel.”)

**Tch:** Automatically match the MIDI channel (Sequencer 2-1a) of the track selected by **Track Select** (Sequencer 0-1a).

**Example 1**

With the following settings, switching **Track Select** (the track you play) to change programs will also switch to a different KARMA Module at the same time, causing a different phrase to play. (See the diagram “Example 1,” below.)

1. Set MIDI Track 1 as follows.
  - “Program Select”: a Guitar category program
  - MIDI Channel: 01
2. Set MIDI Track 2 as follows.

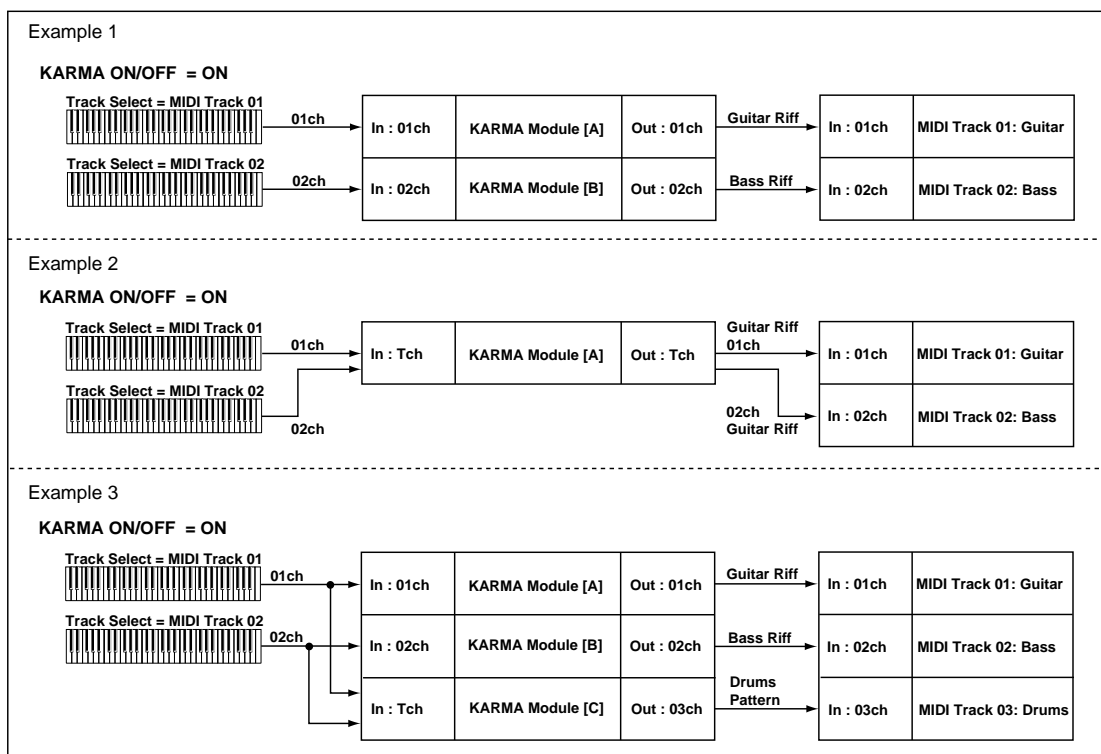

“Program Select”: a Bass category program  
MIDI Channel: 02

**3. Set KARMA Module A as follows.**

“GE Select”: a riff of GE category Guitar

“Input Channel”: 01

“Output Channel” 01

**4. Set KARMA Module B as follows.**

“GE Select”: a riff of GE category Bass

“Input Channel”: 02

“Output Channel” 02

**5. In Track Select, select Track01, and play the keyboard.**

(KARMA function on)

The Guitar riff of KARMA Module A will be sounded by the Guitar type program.

**6. In Track Select, select Track02, and play the keyboard.**

(KARMA function on)

The Bass riff of KARMA Module B will be sounded by the Bass type program.

**Example 2**

With the following settings, switching **Track Select** (the track you play) to change programs will not switch to a different KARMA Module --- the same phrase will still be played. (See the diagram “**Example 2,**” below.)

**1. Set MIDI Track 1 as follows.**

“Program Select”: a Guitar category program

MIDI Channel: 01

**2. Set MIDI Track 2 as follows.**

“Program Select”: a Bass category program

MIDI Channel: 02

**3. Set KARMA Module A as follows.**

“GE Select”: a riff of GE category Guitar

“Input Channel”: Tch

“Output Channel” Tch

**4. In Track Select, select Track01, and play the keyboard.**

The Guitar riff of KARMA Module A will be sounded by the Guitar type program.

**5. In Track Select, select Track02, and play the keyboard.**

The Guitar riff of KARMA Module A will be sounded by the Bass type program.

**Example 3**

With the following settings, switching **Track Select** (the track you play) to change programs will also switch to a different KARMA Module at the same time, causing a different phrase to play. At this time, the rhythm track can be triggered and controlled from either track. (See the diagram “**Example 3**” at the bottom of previous page.)

**1. Set MIDI Track 1 as follows.**

“Program Select”: a Guitar category program

MIDI Channel: 01

**2. Set MIDI Track 2 as follows.**

“Program Select”: a Bass category program

MIDI Channel: 02

**3. Set MIDI Track 3 as follows.**

“Program Select”: a drum program (a Drums category program)

MIDI Channel: 03

**4. Set KARMA Module A as follows.**

“GE Select”: a riff of GE category Guitar

“Input Channel”: 01

“Output Channel” 01

**5. Set KARMA Module B as follows.**

“GE Select”: a riff of GE category Bass

“Input Channel”: 02

“Output Channel” 02

**6. Set KARMA Module C as follows.**

“GE Select”: a drum pattern (a pattern of GE category Drums)

“Input Channel”: Tch

“Output Channel” 03

**7. In Track Select, select Track01, and play the keyboard.**

(KARMA function on)

The Guitar riff of KARMA Module A will be sounded by the Guitar type program.

Simultaneously, the drum pattern of KARMA Module C will be sounded by the Drums program.

**8. In Track Select, select Track02, and play the keyboard.**

(KARMA function on)

The Bass riff of KARMA Module B will be sounded by the Bass type program.

Simultaneously, the drum pattern of KARMA Module C will be sounded by the Drums program.

**Track Thru (when KARMA Off) [Off, On]**

“Input Channel” and “Output Channel” settings are normally valid only when the KARMA ON/OFF switch is on.

As an exception, “Track Thru” specifies whether the MIDI data that passes through the KARMA Module will be sent (Thru) to the track when the KARMA ON/OFF switch is off.

**On (checked):** MIDI data that passes through the KARMA Module will be sent on the “Output Channel” to the track when the KARMA ON/OFF switch is off.

**Off (unchecked):** MIDI data that passes through the KARMA Module will not be sent to the track when the KARMA ON/OFF switch is off.

For examples of using this setting, see “Timbre Thru (when KARMA Off)” on page 472.

**Module – Track MIDI Display**

This shows the MIDI tracks that will be sounded by each KARMA Module, according to the MIDI output channel settings of each KARMA Module and the MIDI channel of each track (Sequencer 2–1b: **MIDI Channel**).

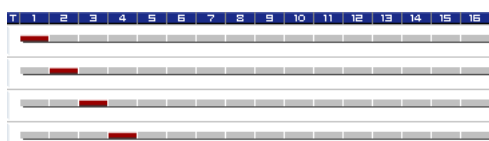

**▼ 7–1: Page Menu Commands**

The number before each command shows its ENTER + number-key shortcut. For more information on these shortcuts, see “ENTER + 0-9: shortcuts for menu commands” on page 147.

- **0: Memory Status.** For more information, see “Memory Status” on page 624.
- **1: Exclusive Solo.** For more information, see “Exclusive Solo” on page 147.
- **2: Copy KARMA Module.** For more information, see “Copy KARMA Module” on page 504.
- **3: Initialize KARMA Module.** For more information, see “Initialize KARMA Module” on page 505.
- **4: Copy Scene.** For more information, see “Copy Scene” on page 505.
- **5: Swap Scene.** For more information, see “Swap Scene” on page 505.
- **6: Capture Random Seed.** For more information, see “Capture Random Seed” on page 505.
- **7: FF/REW Speed.** For more information, see “FF/REW Speed” on page 625.
- **8: Set Location (for Locate Key).** For more information, see “Set Location (for Locate Key)” on page 626.
- **9: Copy From Program.** For more information, see “Copy From Program” on page 626.

## 7-2: MIDI Filter/CC Offset

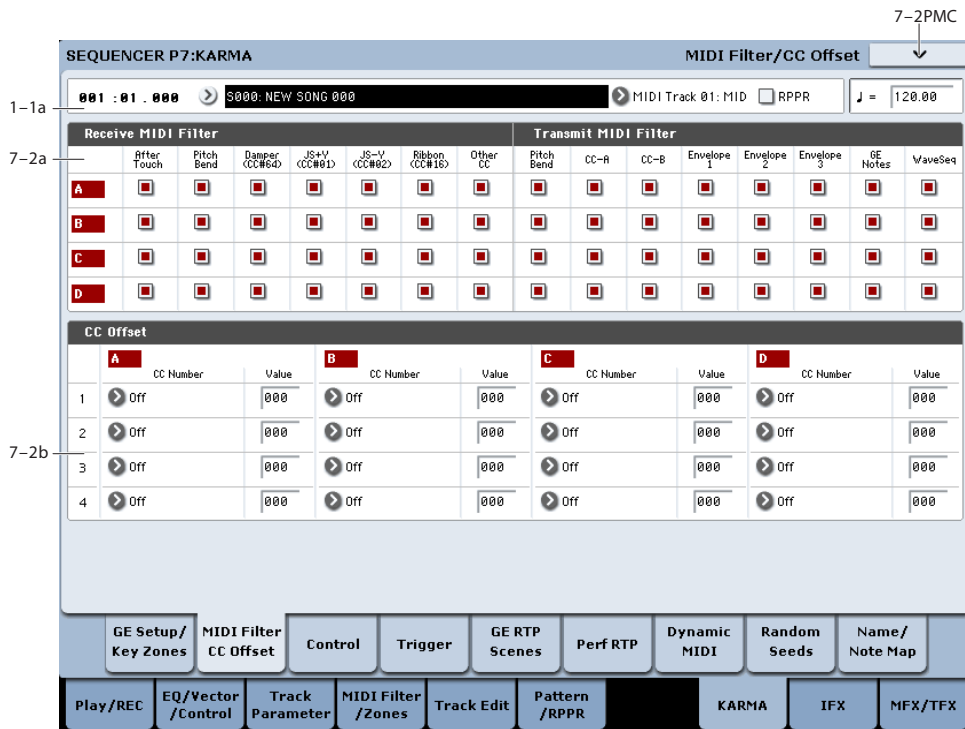

### 7-2a: MIDI Filter

#### Receive MIDI Filter

<b>After Touch</b>	[Off, On]
<b>Pitch Bend</b>	[Off, On]
<b>Damper (CC#64)</b>	[Off, On]
<b>JS+Y (CC#01)</b>	[Off, On]
<b>JS-Y (CC#02)</b>	[Off, On]
<b>Ribbon (CC#16)</b>	[Off, On]
<b>Other CC</b>	[Off, On]

For more information, see “Receive MIDI Filter” on page 110.

#### Transmit MIDI Filter

<b>Pitch Bend</b>	[Off, On]
<b>CC-A, CC-B</b>	[Off, On]
<b>Envelope1, Envelope2, Envelope3</b>	[Off, On]
<b>GE Notes</b>	[Off, On]
<b>WaveSeq</b>	[Off, On]

Please see “Transmit MIDI Filter” on page 111 and “Transmit MIDI Filter” on page 474.

### 7-2b: CC Offset

These settings specify the MIDI control change messages and values that are transmitted from each KARMA Module to the tone generator when you press the KARMA ON/OFF switch to turn on KARMA or when you select a song for which KARMA is turned on.

These messages will be transmitted on the “Output Channel” (Sequencer 7-1c) of the KARMA Module.

*Note:* If the GE also generates the same control change messages as those you specify here, the control change messages generated by the GE will be given priority.

#### 1, 2, 3, 4

**CC Number** [Off, MIDI CC#00...CC#95]

**Value** [000...127]

For more information, see “7-2b: CC Offset” on page 474.

### ▼ 7-2: Page Menu Commands

The number before each command shows its ENTER + number-key shortcut. For more information on these shortcuts, see “ENTER + 0-9: shortcuts for menu commands” on page 147.

- 0: **Memory Status.** For more information, see “Memory Status” on page 624.
- 1: **Exclusive Solo.** For more information, see “Exclusive Solo” on page 147.
- 2: **Copy KARMA Module.** For more information, see “Copy KARMA Module” on page 504.



- 3: **Initialize KARMA Module.** For more information, see “Initialize KARMA Module” on page 505.
- 4: **Copy Scene.** For more information, see “Copy Scene” on page 505.
- 5: **Swap Scene.** For more information, see “Swap Scene” on page 505.
- 6: **Capture Random Seed.** For more information, see “Capture Random Seed” on page 505.
- 7: **FF/REW Speed.** For more information, see “FF/REW Speed” on page 625.
- 8: **Set Location (for Locate Key).** For more information, see “Set Location (for Locate Key)” on page 626.
- 9: **Copy From Program.** For more information, see “Copy From Program” on page 626.

## 7-3: Module Parameters-Control

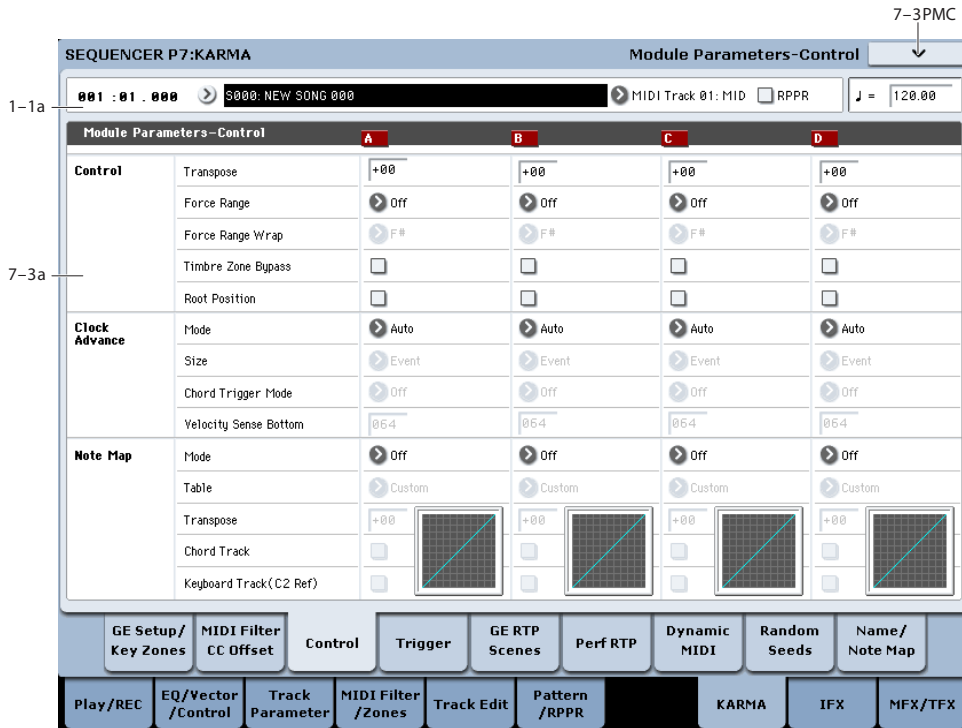

Here you can set KARMA Module Control parameters. In Sequencer mode, four KARMA Modules (A, B, C, and D) can be used.

### 7-3a: Module Parameter-Control

#### Control

- Transpose** [-36...+36]
- Force Range** [Off, Lowest, Highest, C3-B3[1], C3-B3[2]]
- Force Range Wrap** [C#...C]
- Timbre Zone Bypass** [Off, On]
- Root Position** [Off, On]

For more information, see “Control” on page 113 and “Control” on page 475.

#### Clock Advance

- Mode** [Auto, Dyn, Auto+Dyn1, Auto+Dyn2]
- Size** [Event]
- Chord Trigger Mode** [Off, 1st, Chord1, Chord2, Chord3]
- Velocity Sense Bottom** [001...127]

Please see “Clock Advance” on page 114.

#### Note Map

- Mode (Note Map Mode)** [Off, On-Main, On-Rpt, On-All]
- Table (Note Map Table)** [Custom, Gtable 1...Maj 7 -> oct]
- Transpose (Note Map Transpose)** [-12...+12]
- Chord Track (Note Map Chord Track)** [Off, On]
- Keyboard Track (C2 Ref)**

**(Note Map Keyboard Track) [Off, On]**

**Note Map Table Display**

For more information, see “Note Map” on page 115.

**▼ 7-3: Page Menu Commands**

The number before each command shows its ENTER + number-key shortcut. For more information on these shortcuts, see “ENTER + 0-9: shortcuts for menu commands” on page 147.

- 0: **Memory Status.** For more information, see “Memory Status” on page 624.
- 1: **Exclusive Solo.** For more information, see “Exclusive Solo” on page 147.
- 2: **Copy KARMA Module.** For more information, see “Copy KARMA Module” on page 504.
- 3: **Initialize KARMA Module.** For more information, see “Initialize KARMA Module” on page 505.
- 4: **Copy Scene.** For more information, see “Copy Scene” on page 505.
- 5: **Swap Scene.** For more information, see “Swap Scene” on page 505.
- 6: **Capture Random Seed.** For more information, see “Capture Random Seed” on page 505.
- 7: **FF/REW Speed.** For more information, see “FF/REW Speed” on page 625.
- 8: **Set Location (for Locate Key).** For more information, see “Set Location (for Locate Key)” on page 626.
- 9: **Copy From Program.** For more information, see “Copy From Program” on page 626.

**7-4: Module Parameters-Trigger**

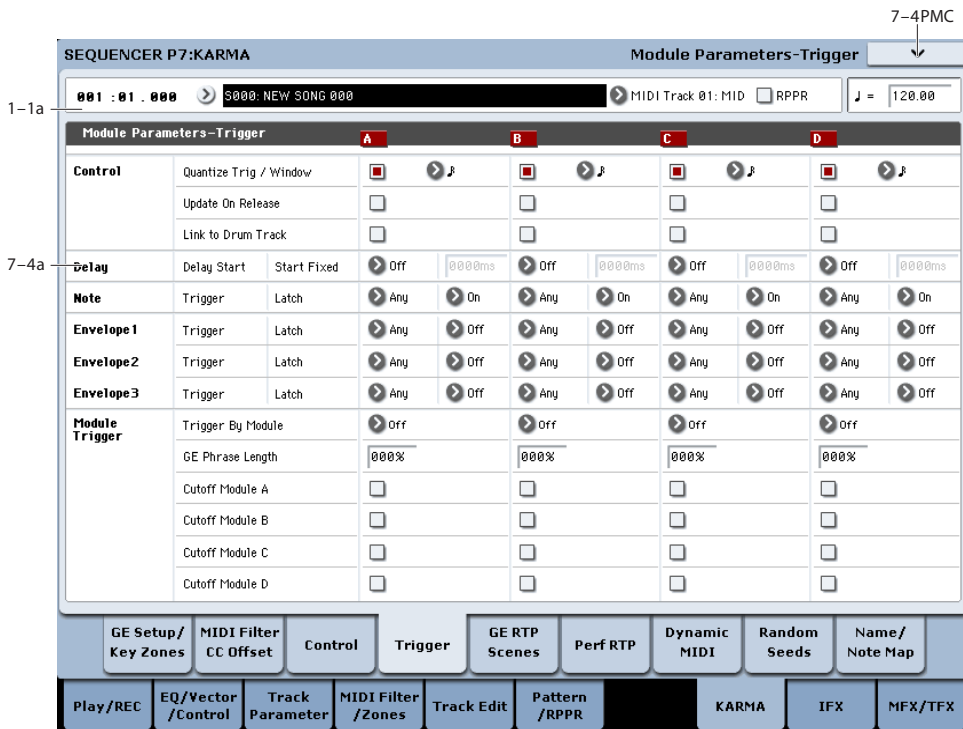

Here you can specify the trigger parameters for each KARMA Module, and whether it will be latched.

**7-4a: Module Parameter-Trigger**

**Control**

- Quantize Trigger** [Off, On]
- Quantize Window** [♪...♪]
- Update On Release** [Off, On]
- Link to Drum Track** [Off, On]

For more information, please see “Control” on page 117.

**Delay**

**Delay Start** [Off, Fixed, 64T ...4x1]

**Delay Start Fixed** [0000ms...5000ms]

For more information, please see “Delay” on page 118.

**Note**

**Note Trigger** [Any, AKR, 1st, Dyn]

**Note Latch** [Off, On]

For more information, please see “Note” on page 118 and “Note” on page 477.

**Envelope1, Envelope2, Envelope3**

**Envelope Trigger** [Any, AKR, 1st, Dyn]

**Envelope Latch** [Off, Sus1, Rel1, Sus2, Rel2]

For more information, please see “Envelope1, Envelope2, Envelope3” on page 118.

**Module Trigger**

**Trigger By Module** [Off, A, B, C, D]

**GE Phrase Length** [000...100%]

**Cutoff Module A, B, C, D** [Off, On]

For more information, please see “Module Trigger” on page 477.

- **0: Memory Status.** For more information, see “Memory Status” on page 624.
- **1: Exclusive Solo.** For more information, see “Exclusive Solo” on page 147.
- **2: Copy KARMA Module.** For more information, see “Copy KARMA Module” on page 504.
- **3: Initialize KARMA Module.** For more information, see “Initialize KARMA Module” on page 505.
- **4: Copy Scene.** For more information, see “Copy Scene” on page 505.
- **5: Swap Scene.** For more information, see “Swap Scene” on page 505.
- **6: Capture Random Seed.** For more information, see “Capture Random Seed” on page 505.
- **7: FF/REW Speed.** For more information, see “FF/REW Speed” on page 625.
- **8: Set Location (for Locate Key).** For more information, see “Set Location (for Locate Key)” on page 626.
- **9: Copy From Program.** For more information, see “Copy From Program” on page 626.

**▼ 7-4: Page Menu Commands**

The number before each command shows its ENTER + number-key shortcut. For more information on these shortcuts, see “ENTER + 0-9: shortcuts for menu commands” on page 147.

**7-5: GE Real-Time Parameters/Scenes**

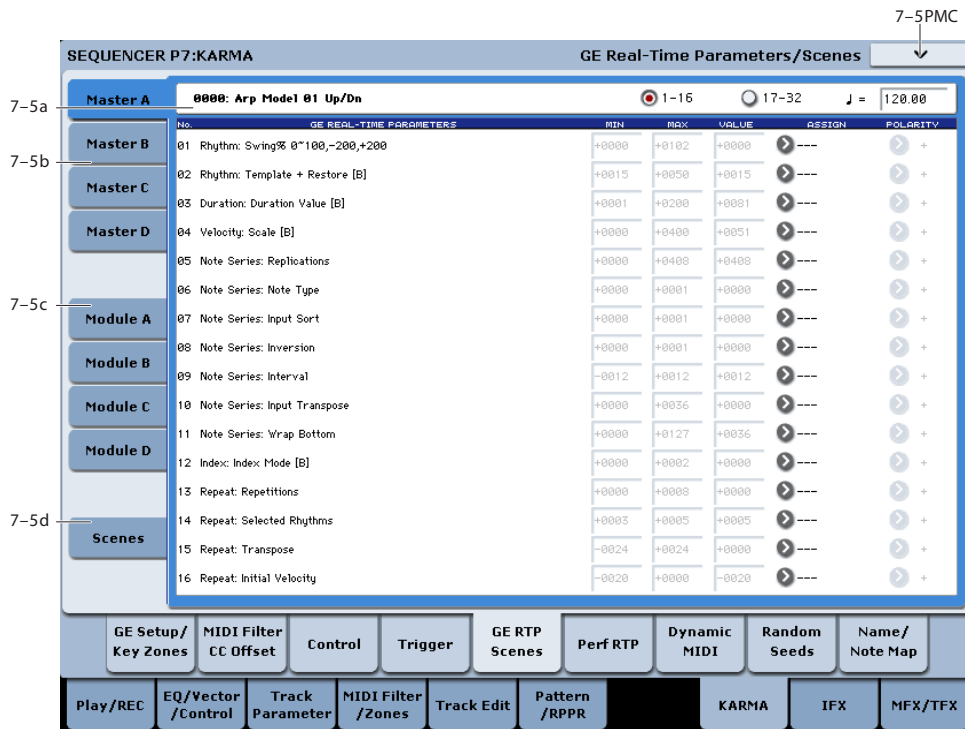

Here you can edit the Real-Time Parameters of the GE for each KARMA Module, A–D. In addition, you can assign GE Real-Time Parameters to the KARMA Real-Time Controls so that you can control the phrase or pattern in real-time while you play.

**7-5a: GE No. & Name, GE RTC Select, Tempo**

**GE Number & Name**

This indicates the number and name of the GE that is selected for each KARMA Module.

**GE RTC Select [1-16, 17-32]**

For more information, see "GE RTC Select" on page 120.

♪ (Tempo) [040.00...300.00, EXT]

For more information, see "Tempo" on page 5.

**7-5b: GE Real-Time Parameters for Module Control = Master**

**GE PARAMETER [Parameter Name]**

**MIN (Minimum Value) [-5000...+5000]**

**MAX (Maximum Value) [-5000...+5000]**

**VALUE [-5000...+5000]**

**ASSIGN [---, Slider1...8, Slider (SW)1...8, SW1...8, DynaMIDI1...8]**

**POLARITY [+,-]**

For more information, see "7-5b: GE Real-Time Parameters" on page 120 and "7-5b: GE Real-Time Parameters for Module Control = Master" on page 478.

*Note:* Normally, the MIN, MAX, VALUE, and POLARITY parameters of each module are specified in module A, B, C, and D. These parameter settings are possible if you specify ASSIGN in Master A, B, C, and D.

For example, if you want to use Slider1 to control the GE REALTIME PARAMETER No.1 of modules A, B, C, and D when Module Control is set to Master, you would set the Master, A, B, C, and D's GE REALTIME PARAMETER No.01 ASSIGN to Slider1. If these are set to ASSIGN, you are able to edit the MIN, MAX, VALUE, and POLARITY parameters for Master, A, B, C, and D.

In this way, you can make GE realtime parameter settings independently of modules A, B, C, and D.

**7-5c: GE Real-Time Parameters for Module Control = A, B, C, D (1-32)**

For details on the parameters in this section, see "7-5b: GE Real-Time Parameters" on page 120, and "7-5c: GE Real-Time Parameters for Module Control = A, B, C, D" on page 479.

**7-5d: Scene Matrix**

For details on the parameters in this section, see "7-5d: Module Control Scene Matrix" on page 479.

**Scene Change Quantize Window**

**Scene Change Quantize Window** [♪ ... ♪] 1 Bar...4 Bars

**Scene Selection**

**Master [1...8]**

**A [1...8]**

**B [1...8]**

**C [1...8]**

**D [1...8]**

**Link Scenes To Master**

**A [Off, On]**

**B [Off, On]**

**C [Off, On]**

**D [Off, On]**

**Enable RTC By Master**

**A [Off, On]**

**B [Off, On]**

**C [Off, On]**

**D [Off, On]**

**Drum Track Run**

**Drum Track Run 1...8 [Off, On]**

**▼ 7-5: Page Menu Commands**

The number before each command shows its ENTER + number-key shortcut. For more information on these shortcuts, see "ENTER + 0-9: shortcuts for menu commands" on page 147.

- 0: **Memory Status.** For more information, see "Memory Status" on page 624.
- 1: **Exclusive Solo.** For more information, see "Exclusive Solo" on page 147.
- 2: **Copy KARMA Module.** For more information, see "Copy KARMA Module" on page 504.
- 3: **Initialize KARMA Module.** For more information, see "Initialize KARMA Module" on page 505.
- 4: **Copy Scene.** For more information, see "Copy Scene" on page 505.
- 5: **Swap Scene.** For more information, see "Swap Scene" on page 505.
- 6: **Capture Random Seed.** For more information, see "Capture Random Seed" on page 505.
- 7: **FF/REW Speed.** For more information, see "FF/REW Speed" on page 625.
- 8: **Set Location (for Locate Key).** For more information, see "Set Location (for Locate Key)" on page 626.
- 9: **Copy From Program.** For more information, see "Copy From Program" on page 626.

## 7-6: Perf Real-Time Parameters

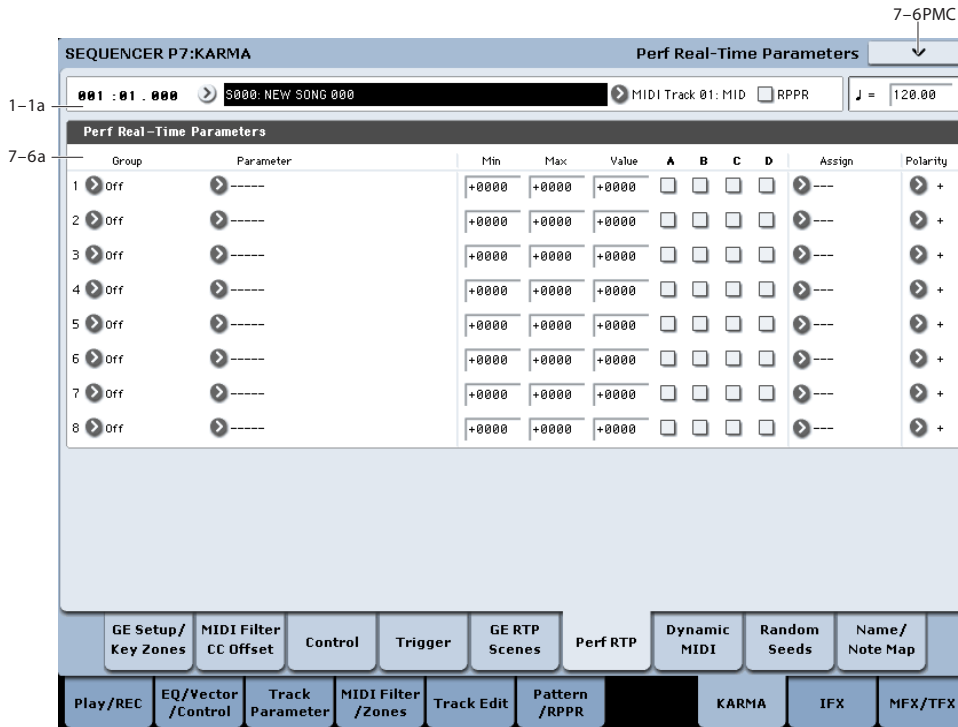

Here you can assign controllers to KARMA Performance Real-Time Parameters (Perf. RTP) outside of the GE Real-Time Parameters that control the internal settings of the GE. Examples include the KARMA Key Zone parameters (Combination 7-1b) and KARMA Control and Trigger parameters (Combination 7-3, 7-4).

For more information, please see “7-6a: Perf Real-Time Parameters (1...8)” on page 481.

### 7-6a: Perf Real-Time Parameters

1...8

**Group** [Off, PE, Mix, Control, Trigger, Key Zones, Random Seeds]

**Parameter** [---, Time Signature..., Retrigger Each Time]

**Min (Minimum Value)** [-8192...+8191]

**Max (Maximum Value)** [-8192...+8191]

**Value** [-8192...+8191]

**A/B/C/D** [Off, On]

**Assign** [---, Slider1...8, Slider1...8(SW), SW1...8, DynaMIDI1...8]

**Polarity** [+,-]

Please see “7-6b: Perf Real-Time Parameters” on page 123, and “7-6a: Perf Real-Time Parameters (1...8)” on page 481.

### 7-6: Page Menu Commands

The number before each command shows its ENTER + number-key shortcut. For more information on these shortcuts, see “ENTER + 0-9: shortcuts for menu commands” on page 147.

- 0: **Memory Status**. For more information, see “Memory Status” on page 624.
- 1: **Exclusive Solo**. For more information, see “Exclusive Solo” on page 147.
- 2: **Copy KARMA Module**. For more information, see “Copy KARMA Module” on page 504.
- 3: **Initialize KARMA Module**. For more information, see “Initialize KARMA Module” on page 505.
- 4: **Copy Scene**. For more information, see “Copy Scene” on page 505.
- 5: **Swap Scene**. For more information, see “Swap Scene” on page 505.
- 6: **Capture Random Seed**. For more information, see “Capture Random Seed” on page 505.
- 7: **FF/REW Speed**. For more information, see “FF/REW Speed” on page 625.
- 8: **Set Location (for Locate Key)**. For more information, see “Set Location (for Locate Key)” on page 626.
- 9: **Copy From Program**. For more information, see “Copy From Program” on page 626.

## 7-7: Dynamic MIDI

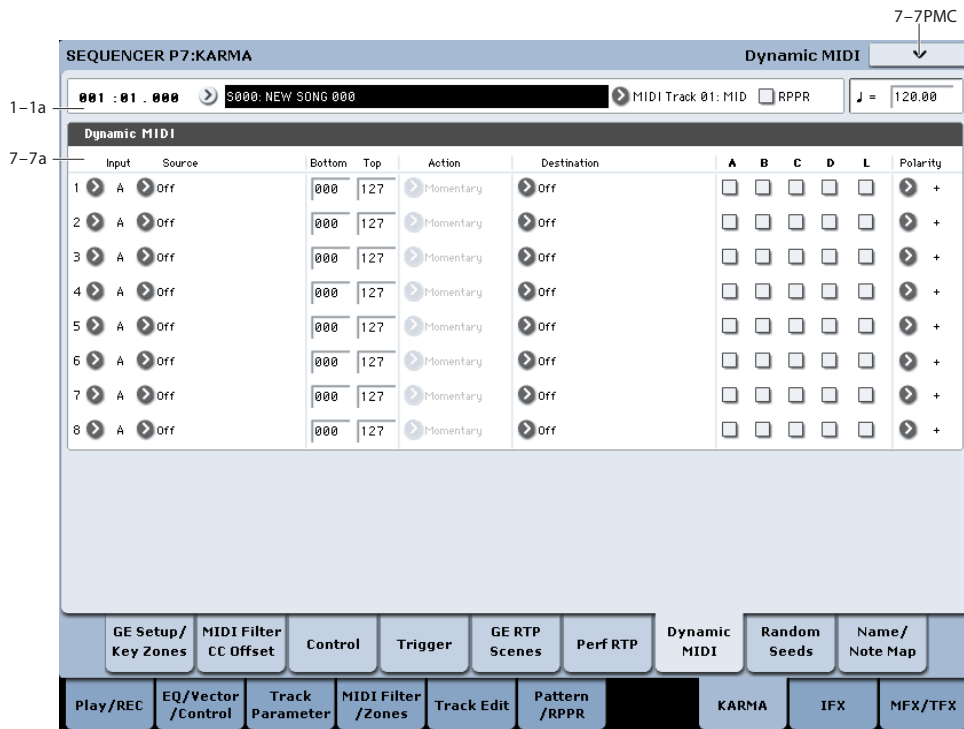

Dynamic MIDI is a function that lets you use the KRONOS's controllers and MIDI control messages to modulate specific KARMA functions.

For more information, please see "7-7b: Dynamic MIDI" on page 128 and p.482.

### 7-7a: Dynamic MIDI

<b>Input (Input Module)</b>	[A...D]
<b>Source</b>	[Off, JS+Y (CC#01)... Velocity Outside Zone]
<b>Bottom (Range Bottom)</b>	[000...127]
<b>Top (Range Top)</b>	[000...127]
<b>Action (Range Action)</b>	[Momentary, Toggle, Continuous]
<b>Destination</b>	[Off, RT Params Control...Buffer Latch]
<b>A/B/C/D</b>	[Off, On]
<b>L (Last Triggered)</b>	[Off, On]
<b>Polarity (Dynamic MIDI Polarity)</b>	[+, -, +/-, -/+]

For more information, see "7-7b: Dynamic MIDI" on page 128 and p.482.

### ▼ 7-7: Page Menu Commands

The number before each command shows its ENTER + number-key shortcut. For more information on these shortcuts, see "ENTER + 0-9: shortcuts for menu commands" on page 147.

- 0: **Memory Status**. For more information, see "Memory Status" on page 624.
- 1: **Exclusive Solo**. For more information, see "Exclusive Solo" on page 147.
- 2: **Copy KARMA Module**. For more information, see "Copy KARMA Module" on page 504.
- 3: **Initialize KARMA Module**. For more information, see "Initialize KARMA Module" on page 505.
- 4: **Copy Scene**. For more information, see "Copy Scene" on page 505.
- 5: **Swap Scene**. For more information, see "Swap Scene" on page 505.
- 6: **Capture Random Seed**. For more information, see "Capture Random Seed" on page 505.
- 7: **FF/REW Speed**. For more information, see "FF/REW Speed" on page 625.
- 8: **Set Location (for Locate Key)**. For more information, see "Set Location (for Locate Key)" on page 626.
- 9: **Copy From Program**. For more information, see "Copy From Program" on page 626.

## 7-8: Random Seeds

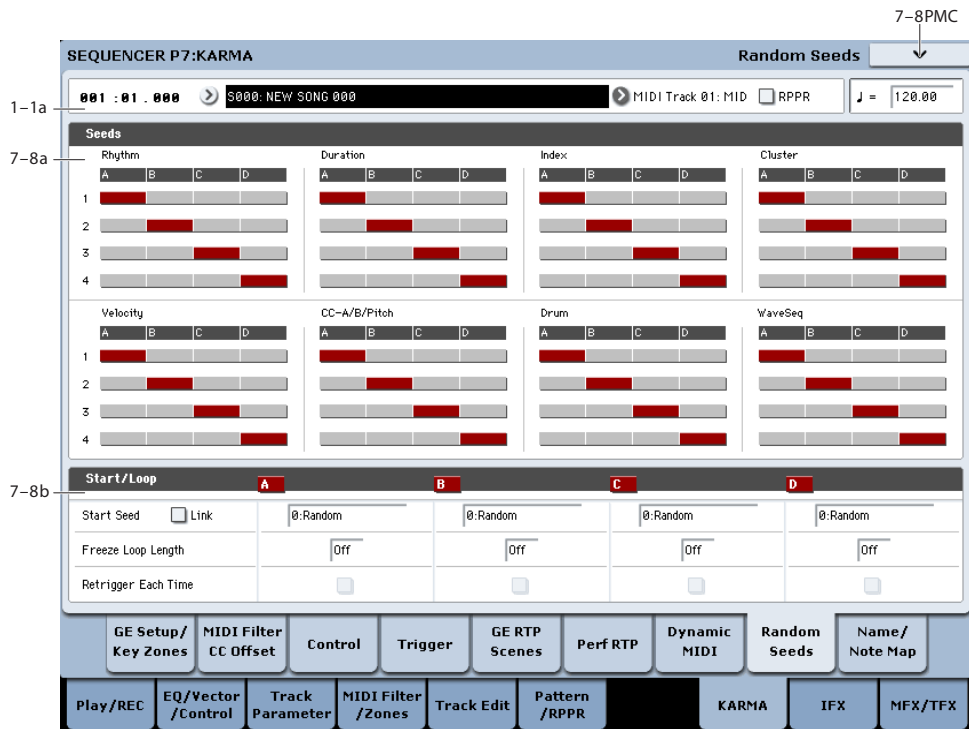

The Random Seeds page allows you to control some of the randomizable characteristics of a Module’s GE. Different Modules using the same GE can have various randomizable characteristics “linked” so that they share the same start seeds, generating phrases with the same characteristics.

### 7-8a: Seed

**Rhythm, Duration, Index, Cluster, Velocity, CC-A/B, Drum, WaveSeq**

<b>A</b>	[1, 2, 3, 4]
<b>B</b>	[1, 2, 3, 4]
<b>C</b>	[1, 2, 3, 4]
<b>D</b>	[1, 2, 3, 4]

Please see “7-8a: Seed” on page 484.

### 7-8b: Start/Loop

**Start Seed** [-2147483648...  
0: Random...+2147483647]

**Link** [Off, On]

Please see “Link to Start Seed” on page 485.

**Freeze Loop Length** [Off, 01...32]

**Retrigger Each Time** [Off, On]

Please see “7-8b: Start” on page 130

### ▼ 7-8: Page Menu Commands

The number before each command shows its ENTER + number-key shortcut. For more information on these shortcuts, see “ENTER + 0-9: shortcuts for menu commands” on page 147.

- 0: **Memory Status**. For more information, see “Memory Status” on page 624.
- 1: **Exclusive Solo**. For more information, see “Exclusive Solo” on page 147.
- 2: **Copy KARMA Module**. For more information, see “Copy KARMA Module” on page 504.
- 3: **Initialize KARMA Module**. For more information, see “Initialize KARMA Module” on page 505.
- 4: **Copy Scene**. For more information, see “Copy Scene” on page 505.
- 5: **Swap Scene**. For more information, see “Swap Scene” on page 505.
- 6: **Capture Random Seed**. For more information, see “Capture Random Seed” on page 505.
- 7: **FF/REW Speed**. For more information, see “FF/REW Speed” on page 625.
- 8: **Set Location (for Locate Key)**. For more information, see “Set Location (for Locate Key)” on page 626.
- 9: **Copy From Program**. For more information, see “Copy From Program” on page 626.



## 7-9: Name/Note Map

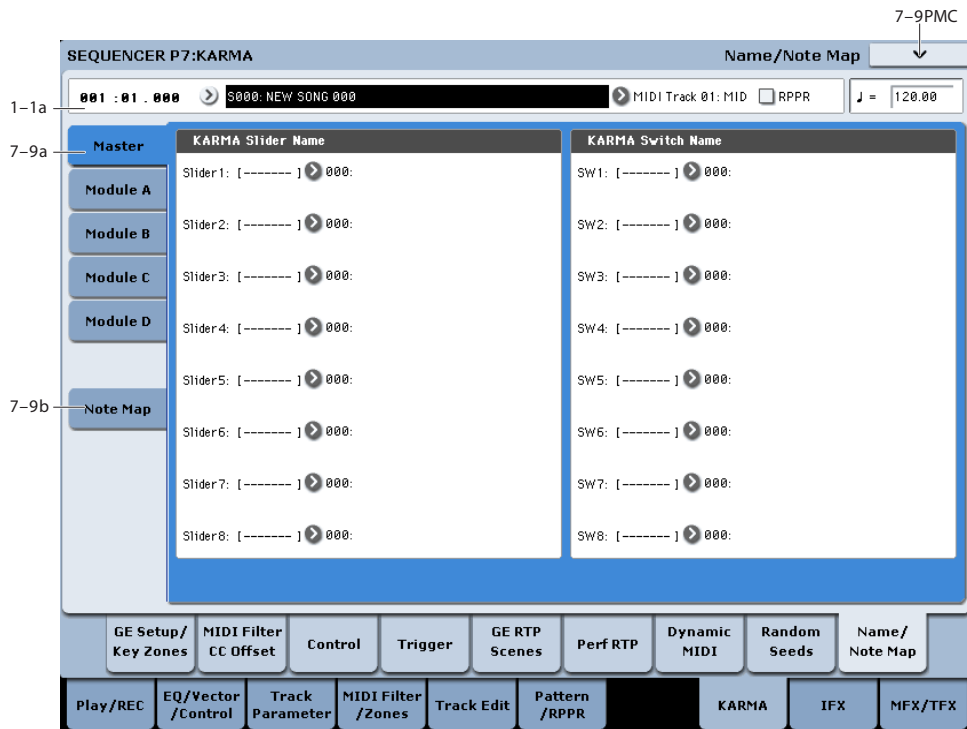

Here you can assign the names for KARMA SLIDERS 1-8 and KARMA SWITCHES 1-8, view Global Note Map Tables, and edit the Custom Note Map Table stored with the Sequence.

### 7-9a: Name

#### Master, Module A...D

Each Module Control layer has its own set of names for each of the KARMA SLIDERS and SWITCHES. For more information, see "7-9b: Module A" on page 132.

**Slider1...8** [000 (no name)...  
571 Waveform Select [16]

**Switch1...8** [000 (no name)...  
571 Waveform Select [16]

### 7-9b: Note Map (Custom)

**Table** [Custom, sidestick/rides1...maj7->oct]

**In (Note In)** [C-1...G9]

**Out (Note Out)** [Remove, C-1...G9]

**Octave Replicate** [Off, On]

**Reset** [button]

Please see "7-9c: Note Map" on page 132.

#### Display Module

Here you can select the KARMA module that you want to edit, and view the Note Map Table.

### ▼ 7-9: Page Menu Commands

The number before each command shows its ENTER + number-key shortcut. For more information on these shortcuts, see "ENTER + 0-9: shortcuts for menu commands" on page 147.

- 0: **Memory Status**. For more information, see "Memory Status" on page 624.
- 1: **Exclusive Solo**. For more information, see "Exclusive Solo" on page 147.
- 2: **Copy KARMA Module**. For more information, see "Copy KARMA Module" on page 504.
- 3: **Initialize KARMA Module**. For more information, see "Initialize KARMA Module" on page 505.
- 4: **Copy Scene**. For more information, see "Copy Scene" on page 505.
- 5: **Swap Scene**. For more information, see "Swap Scene" on page 505.
- 6: **Capture Random Seed**. For more information, see "Capture Random Seed" on page 505.
- 7: **Auto Assign KARMA RTC Name**. For more information, see "Auto Assign KARMA RTC Name" on page 506.
- 8: **FF/REW Speed**. For more information, see "FF/REW Speed" on page 625.
- 9: **Set Location (for Locate Key)**. For more information, see "Set Location (for Locate Key)" on page 626.
- 10: **Copy From Program**. For more information, see "Copy From Program" on page 626.

- 11: Copy Note Map. For more information, see “Copy Note Map” on page 148.

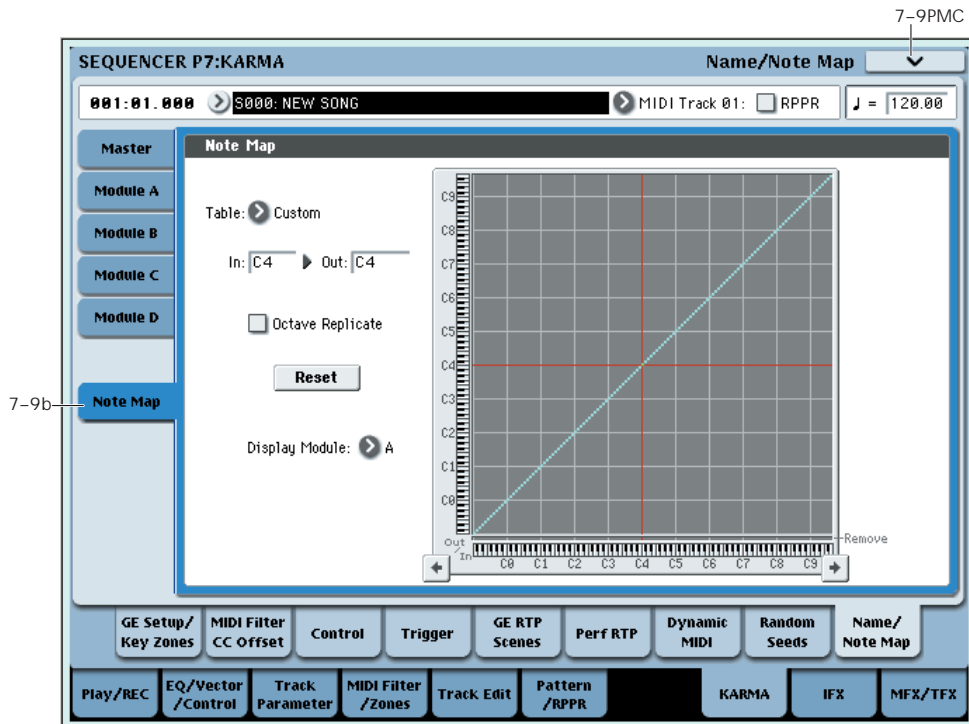

## Sequencer P8: Insert Effect

You can also specify the bus routing for the program used by each MIDI track 1-16 and audio track 1-16. For instance, you can:

- Send the output of a track to an insert effect
- Route a sound to an insert effect

- Make detailed settings for insert effects
- Make common LFO settings for effects

For details on Insert Effects, see “Effect Guide” on page 857.

## 8-1: MIDI Routing1

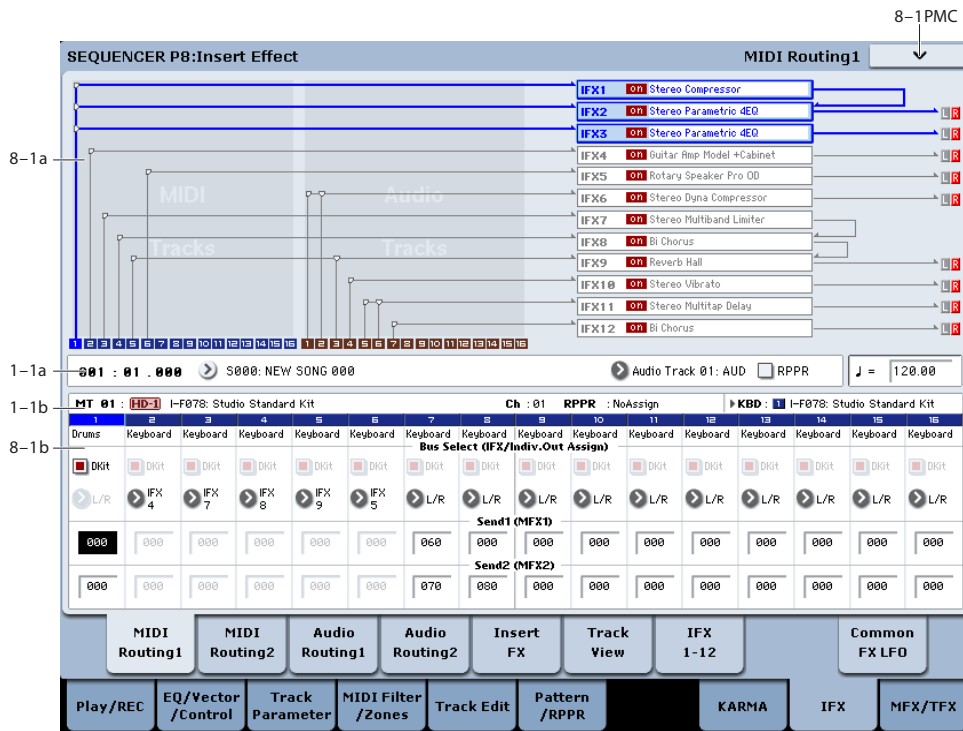

Specifies the bus to which the program oscillator(s) used by each MIDI track 1-16 will be sent. You can also set the send levels to the master effects from this page.

### 8-1a: Routing Map

This area shows the insert effect routing, the name of the assigned effect, the on/off status, chaining, and the output bus that follows the insert effect. The type of insert effect, the on/off status, and the chain settings can be edited in the P8- Insert FX page.

### 8-1b: MIDI Routing1

#### Track 01 (Track Number)

#### Bus Select (IFX/Indiv. Out Assign) Dkit [Off, On]

You can select this only if the specified program is a drum program (Oscillator Mode Drums or Double Drums).

This parameter can also be edited from the P8- MIDI Routing 2 page.

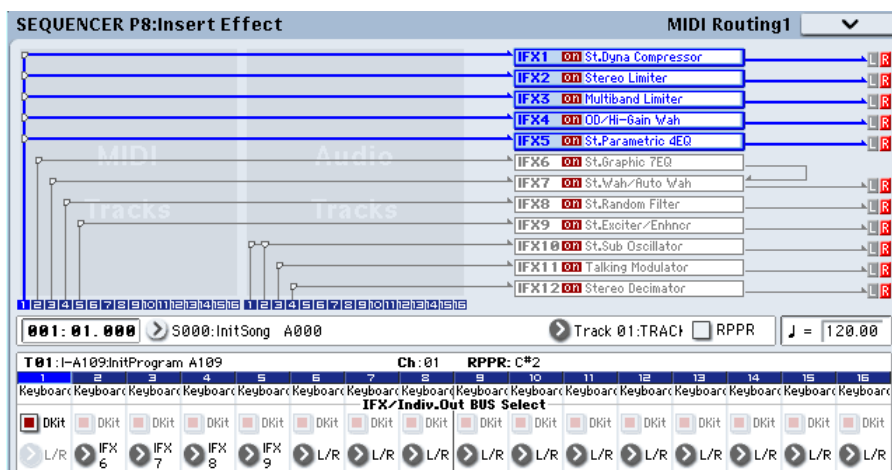

**On (checked):** The **Bus Select**, **FX Control Bus**, **Send1**, and **Send2** settings for each key of the selected drum kit will be used. Check this setting if you want to apply an individual insert effect to each drum instrument, or to send individual drum instruments to AUDIO OUTPUT (INDIVIDUAL).

*Tip:* In most preloaded drumkits, the drum instruments have the same **Bus Select** settings according to their type, as follows.

Snares → IFX1

Kicks → IFX2

Toms → IFX3

Cymbals → IFX4

Percussion etc. → IFX5

If you want to edit these routings, use the “Drum Kit IFX Patch” page menu command. For details, see “Drum Kit IFX Patch” on page 506.

**Off (unchecked):** The **Bus Select**, **FX Control Bus**, and **Send 1/2** settings will be used. All drum instruments will be sent to the specified bus.

### Bus Select (IFX/Indiv.Out Assign)

[L/R, IFX1...12, 1...4, 1/2...3/4, Off]

This specifies the output bus for the track’s program oscillator. This parameter can also be edited from the P8– MIDI Routing 2 page.

**L/R:** Output to the L/R bus.

**IFX1...12:** Output to the IFX1–12 buses.

**1...4:** The track will be output in mono from the corresponding AUDIO OUTPUT (INDIVIDUAL).

**1/2...3/4:** The track will be output in stereo according to its pan setting from the corresponding AUDIO OUTPUT (INDIVIDUAL) pairs.

**Off:** The track will not be output from the L/R bus, IFX1–12 buses, or Individual 1–4 buses. Choose the Off setting if you want the program oscillator output of the track to be connected in series to a master effect. Use **Send1 (to MFX1)** and **Send2 (to MFX2)** to specify the send levels.

*Tip:* You can create a wide variety of routings by using each track’s **Bus Select** and the **Chain to** and **Chain** settings (8–5a) that follow the insert effect.

**Send1 (MFX1)** [000...127]

**Send2 (MFX2)** [000...127]

For each track, these parameters set the send level to master effects 1 and 2. These settings are valid when **Bus Select** is set to L/R or Off. When IFX 1–12 are selected, the send levels to master effects 1 and 2 are set by the **Send1** and **Send2** parameters of the Insert FX page, after the sound has passed through IFX1–12.

If **Bus Select** is set to 1...4 or 1/2...3/4, these settings are ignored.

The Send 1 and 2 setting you specify here are used when playing-back or recording from the beginning of the song. If you modify these settings during recording, your changes will be recorded as performance data; the send amounts will change accordingly during playback. You can also modify

these settings during playback. However if Send 1 and 2 data has been recorded, the settings will change according to the recorded data.

*Note:* You can use the control surface to control Send1 and Send2. These can also be controlled from the mixer section of the front panel, or from the P0– Control Surface page of the LCD screen. The procedure given below describes how to make these settings from the front panel.

1. Press the **CONTROL ASSIGN MIXER TIMBRE/TRACK** switch to select either tracks 1–8 or 9–16.
2. Press the **MIXER KNOBS** switch to select **CHANNEL STRIP**.
3. Use the **MIXER SELECT 1/9–8/16** switches to select the track whose send levels you want to adjust.
4. Use **MIX CHANNEL STRIP “FX SEND 1” (knob 7)** and **“FX SEND 2” (knob 8)** to control the send levels.

If **Bus Select (IFX/Indiv. Out Assign)** is set to L/R or Off, this will control “Send1 (MFX1)”–“Send2 (MFX2).” If **Bus Select (IFX/Indiv. Out Assign)** is set to IFX1–12, this will control **Send1** and **Send2** (P8– Insert FX page).

**MIDI** If **Status (2–1a)** is either INT or BTH, CC#93 and #91 can be received to control send 1 and 2 respectively and change their settings. When you switch songs or return to the beginning of a song, tracks whose **Status** is EXT, EX2 or BTH will transmit these settings via MIDI. This data will be transmitted on the MIDI channel of each track as set by **MIDI Channel (2–1a)**. The actual send level is determined by multiplying the value of these parameters with the send level settings of the oscillator(s) of the program used by the track (**Send1** and “Send2,” Program 8–1d).

### Track 02... 16 (Track Number)

These settings specify the program oscillator output bus and master effect send levels for MIDI tracks 2 through 16. They are the same as for track 1. See “Track 01”:

## ▼ 8–1: Page Menu Commands

The number before each command shows its ENTER + number-key shortcut. For more information on these shortcuts, see “ENTER + 0-9: shortcuts for menu commands” on page 147.

- 0: **Memory Status.** For more information, see “Memory Status” on page 624.
- 1: **Exclusive Solo.** For more information, see “Exclusive Solo” on page 147.
- 2: **Copy Insert Effect.** For more information, see “Copy Insert Effect” on page 159.
- 3: **Swap Insert Effect.** For more information, see “Swap Insert Effect” on page 159.
- 4: **Drum Kit IFX Patch.** For more information, see “Drum Kit IFX Patch” on page 506.
- 5: **Put Effect Setting To Track.** For more information, see “Put Effect Setting to Track” on page 658.

- 6: **FF/REW Speed**. For more information, see “FF/REW Speed” on page 625.
- 7: **Set Location** (for Locate Key.) For more information, see “Set Location (for Locate Key)” on page 626.

## 8-2: MIDI Routing2

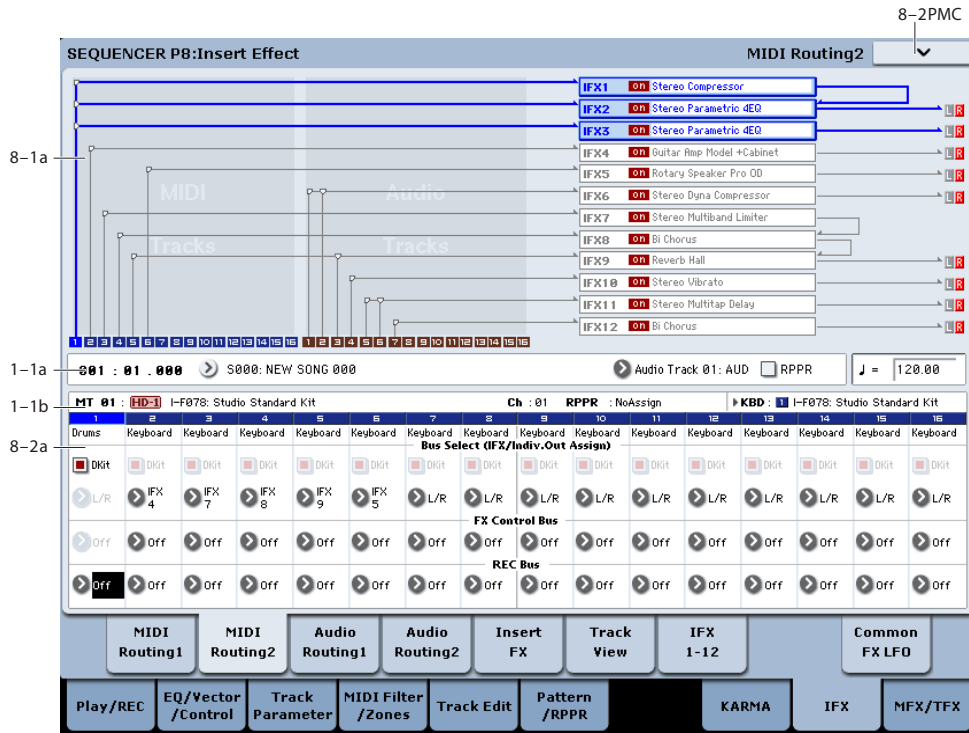

Here you can specify the program oscillator output bus, effect control bus, and REC bus for each MIDI track 1 through 16.

### 8-2a: MIDI Routing2

#### Track 01 (Tack Number)

##### Bus Select (IFX/Indiv. Out Assign) Dkit [Off, On]

You can select this only if the specified program is a drum program (**Oscillator Mode Drums**). These settings can also be made in the Insert Effect-Routing1. For more information, please see “Bus Select (IFX/Indiv. Out Assign) Dkit” on page 609.

##### Bus Select (IFX/Indiv. Out Assign) [L/R, IFX1...12, 1...4, 1/2...3/4, Off]

For each track, these parameters specify the bus to which the program oscillator(s) will be sent. The current settings can also be viewed in the Routing Map. This parameter can also be edited from the P8-MIDI Routing1 page. For more information, please see “Bus Select (IFX/Indiv.Out Assign)” on page 610.

##### FX Control Bus [Off, 1, 2]

Sends the output of the track to an FX Control bus (two-channel stereo FX Ctrl 1 or 2).

Use the FX Control buses when you want a separate sound to control the audio input of an effect. You can use two FX Control buses (each is a two-channel stereo bus) to control effects in various ways.

For more information, please see “FX Control Buses” on page 860.

##### REC Bus (All OSCs to) [Off, 1, 2, 3, 4, 1/2, 3/4]

These settings send the output of the track to the REC buses (four mono channels: 1, 2, 3, 4).

The REC buses are dedicated internal buses for recording, used for sampling in the various modes or for recording audio tracks in Sequencer mode. In Sequencer mode, you can use these buses to record audio tracks onto the hard disk, or to sample.

You will normally use audio track recording to record external audio signals such as guitar or vocal that are input from the Audio Input jacks, but you can also record the playback of MIDI tracks or your performance using the keyboard or KARMA function. Use **REC Bus** to send the desired tracks to the REC buses, and select REC1-4 (REC 1/2, 3/4) as the **REC Source** (0-2a) so that the signals sent to the REC buses can be recorded.

You can also resample (mix-down) the song playback onto the hard disk to create a stereo WAVE file, or sample external audio sources from the Audio Inputs into RAM (the In-Track Sampling function). Use the **REC Bus** setting to send the desired tracks or audio inputs to the REC buses for sampling or resampling, and set **Source Bus** (P0- Audio Input/Sampling 0-8c) to REC1/2 or 3/4 so that these signals can be sampled.

**Off:** The signal will not be sent to a REC bus. Normally you will leave this off.

1, 2, 3, 4: The output of the track will be sent to the corresponding REC bus. The **Pan** setting (0–1b) of each track will be ignored, and the signal will be sent in monaural.

1/2, 3/4: The output of the track will be sent in stereo to the corresponding pair of REC buses. The signal is sent in stereo to REC buses 1/2 or 3/4 according to the **Pan** setting (0–1b) of each track.

**Track 02... 16 (Track Number)**

These settings specify the program oscillator output bus, effect control bus, and REC bus used by MIDI tracks 2 through 16. These are the same as for track 1. See “Track 01”.

▼ **8–2: Page Menu Commands**

The number before each command shows its ENTER + number-key shortcut. For more information on these shortcuts, see “ENTER + 0-9: shortcuts for menu commands” on page 147.

- 0: **Memory Status**. For more information, see “Memory Status” on page 624.
- 1: **Exclusive Solo**. For more information, see “Exclusive Solo” on page 147.
- 2: **Copy Insert Effect**. For more information, see “Copy Insert Effect” on page 159.
- 3: **Swap Insert Effect**. For more information, see “Swap Insert Effect” on page 159.
- 4: **Drum Kit IFX Patch**. For more information, see “Drum Kit IFX Patch” on page 506.
- 5: **Put Effect Setting To Track**. For more information, see “Put Effect Setting to Track” on page 658.
- 6: **FF/REW Speed**. For more information, see “FF/REW Speed” on page 625.
- 7: **Set Location** (for Locate Key.) For more information, see “Set Location (for Locate Key)” on page 626.

**8–3: Audio Routing1**

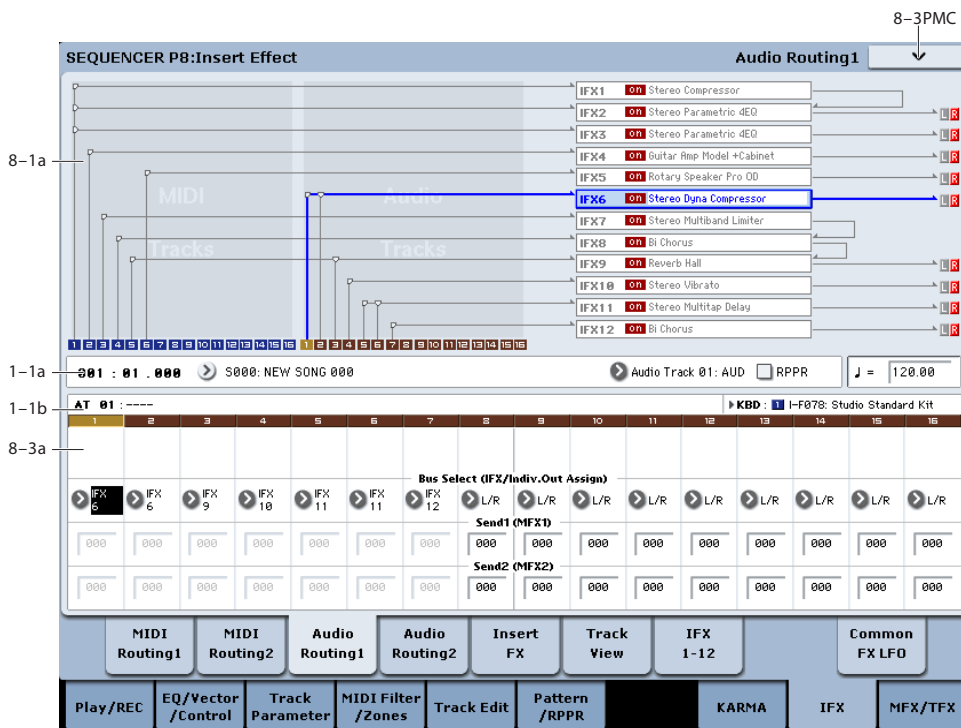

Here you can specify the buses for the outputs of audio tracks 1–16. You can also adjust the send amounts to the master effects.

Audio tracks 1–16 can be processed by the insert effects, master effects, and total effects, and routed to the desired buses, in the same way as for MIDI tracks 1–16.

**8–3a: Audio Routing1**

**Track 01 (Track Number)**

**STEREO**

This is shown if **Stereo Pair** is on.

**Bus Select (IFX/Indiv. Out Assign) [L/R, IFX1...12, 1...4, 1/2...3/4, Off]**

This specifies the bus for the audio track. The current settings can also be viewed in the Routing Map. This parameter can also be edited from the P8– Audio Routing 2 page.

For more information, please see “Bus Select (IFX/Indiv.Out Assign)” on page 610.

**Send1 (MFX1)** [000...127]

**Send2 (MFX2)** [000...127]

For each audio track, these parameters set the send level to master effects 1 and 2. These settings are valid when **Bus Select (IFX/Indiv. Out Assign)** is set to L/R or Off. When IFX 1–12 are selected, the send levels to master effects 1 and 2 are set by the **Send1** and **Send2** parameters of the Insert FX page, after the sound has passed through IFX1–12.

If **Bus Select** is set to 1...4 or 1/2...3/4, these settings are ignored.

The Send 1 and 2 setting you specify here are used when playing-back or recording from the beginning of the song. If you modify these settings during recording, your changes will be recorded as automation event; the send amounts will change accordingly during playback. You can also modify these settings during playback. However if Send 1 and 2 data has been recorded, the settings will change according to the recorded data.

*Note:* You can use the control surface to control Send1 and Send2. These can also be controlled from the mixer section of the front panel, or from the P0- Control Surface page of the LCD screen. The procedure given below describes how to make these settings from the front panel.

1. Press the **CONTROL ASSIGN MIXER AUDIO** switch to select either tracks 1–8 or 9–16.
2. Press the **MIXER KNOBS** switch to select **CHANNEL STRIP**.
3. Use the **MIXER SELECT 1/9–8/16** switches to select the track whose send levels you want to adjust.
4. Use **MIX CHANNEL STRIP “FX SEND 1”** (knob 7) and **“FX SEND 2”** (knob 8) to control the send levels.

If **Bus Select (IFX/Indiv. Out Assign)** is set to L/R or Off, this will control “Send1 (MFX1)”–“Send2 (MFX2).” If **Bus Select (IFX/Indiv. Out Assign)** is set to IFX1–12, this will control **Send1** and **Send2** (P8- Insert FX page).

### **Track 02...16 (Track Number)**

Here you can specify the output bus and master effect send amount for each audio track 2 through 16. These are the same as for track 1. See “Track 01”:

- 3: **Swap Insert Effect**. For more information, see “Swap Insert Effect” on page 159.
- 4: **Stereo Pair**. For more information, see “Stereo Pair” on page 628.
- 5: **Put Effect Setting To Track**. For more information, see “Put Effect Setting to Track” on page 658.
- 6: **FF/REW Speed**. For more information, see “FF/REW Speed” on page 625.
- 7: **Set Location** (for Locate Key.) For more information, see “Set Location (for Locate Key)” on page 626.

## ▼ 8-3: Page Menu Commands

The number before each command shows its ENTER + number-key shortcut. For more information on these shortcuts, see “ENTER + 0-9: shortcuts for menu commands” on page 147.

- 0: **Memory Status**. For more information, see “Memory Status” on page 624.
- 1: **Exclusive Solo**. For more information, see “Exclusive Solo” on page 147.
- 2: **Copy Insert Effect**. For more information, see “Copy Insert Effect” on page 159.



## 8-4: Audio Routing2

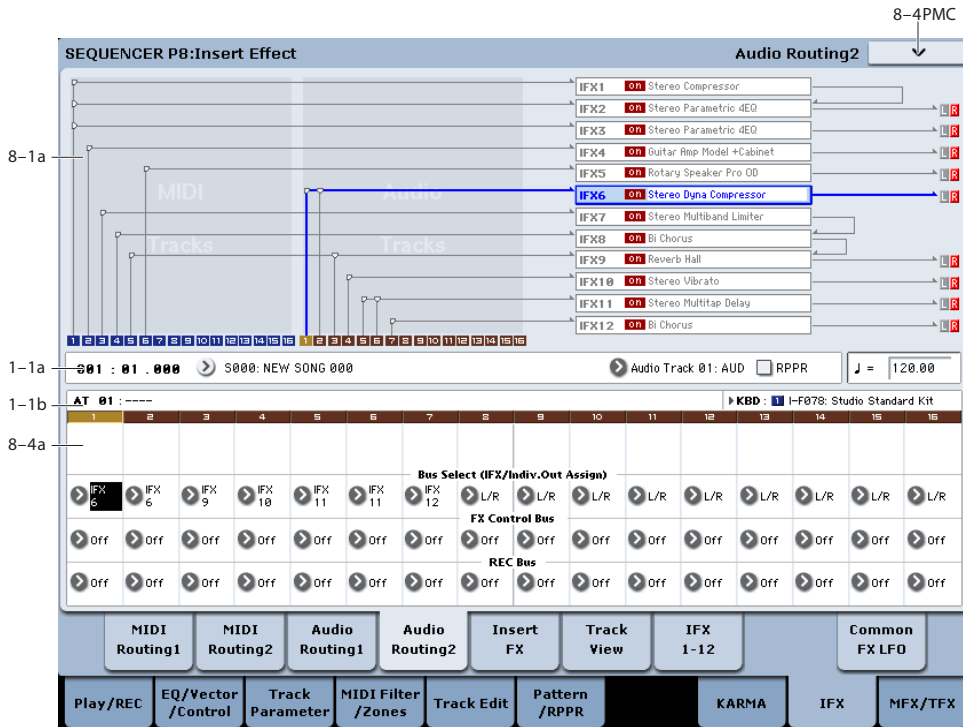

Here you can specify the buses, effect control bus, and REC bus for the outputs of audio tracks 1-16.

### 8-4a: Audio Routing2

#### Track 01 (Track Number)

##### STEREO

This is shown if Stereo Pair is on.

##### Bus Select (IFX/Indiv.Out Assign)

[L/R, IFX1...12, 1...4, 1/2...3/4, Off]

This specifies the bus for the audio track. The current settings can also be viewed in the Routing Map. This parameter can also be edited from the P8- Audio Routing 1 page. For more information, please see "Bus Select (IFX/Indiv.Out Assign)" on page 610.

##### FX Control Bus

[Off, 1, 2]

Sends the output of the audio track to an FX Control bus (two-channel stereo FX Ctrl 1 or 2).

For more information, please see "FX Control Bus" on page 611. For examples, see "FX Control Buses" on page 860.

##### REC Bus

[Off, 1, 2, 3, 4, 1/2, 3/4]

These settings send the output of the audio track to the REC buses (four mono channels: 1, 2, 3, 4). For more information, please see "REC Bus (All OSCs to)" on page 611.

#### Track 02...16 (Track Number)

Here you can specify the output bus, effect control bus, and REC bus for audio tracks 2 through 16. These are the same as for track 1, above.

### ▼ 8-4: Page Menu Commands

The number before each command shows its ENTER + number-key shortcut. For more information on these shortcuts, see "ENTER + 0-9: shortcuts for menu commands" on page 147.

- 0: **Memory Status**. For more information, see "Memory Status" on page 624.
- 1: **Exclusive Solo**. For more information, see "Exclusive Solo" on page 147.
- 2: **Copy Insert Effect**. For more information, see "Copy Insert Effect" on page 159.
- 3: **Swap Insert Effect**. For more information, see "Swap Insert Effect" on page 159.
- 4: **Stereo Pair**. For more information, see "Stereo Pair" on page 628.
- 5: **Put Effect Setting To Track**. For more information, see "Put Effect Setting to Track" on page 658.
- 6: **FF/REW Speed**. For more information, see "FF/REW Speed" on page 625.
- 7: **Set Location** (for Locate Key.) For more information, see "Set Location (for Locate Key)" on page 626.

## 8-5: Insert FX

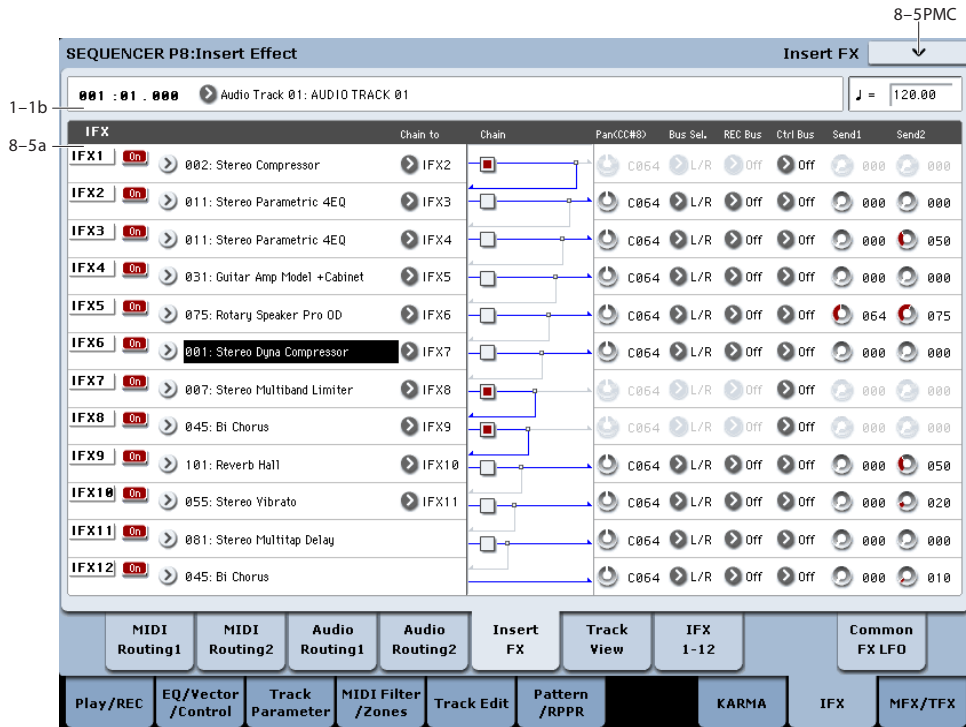

### 8-5a: IFX

Here you can choose the type of each insert effect 1 through 12, its on/off status, chaining, and adjust the post-IFX mixer settings. For insert effects, the direct sound (Dry) is always stereo-in and out. The input/output configuration of the effect sound (Wet) depends on the effect type. For descriptions of the individual effects, please see “Effect Guide,” beginning on page 857.

The following parameters are the same as in Program mode. For details, see “8-5a: IFX” on page 137.

However, unlike in Program mode, insert effect dynamic modulation (Dmod) and the post-IFX **Pan (CC#8)**, **Send1**, and **Send2** are controlled on the MIDI channel specified by “Ch” (8-7a). The control changes used are the same as in Program mode.

The pan (CC#8), send 1 and 2 settings you make here will be used when the song is played or recorded from the beginning. If you change the settings while recording a MIDI track, the changes will be recorded as part of the musical data, and the settings will change when the data is played back. You can also change these settings during playback. However if pan (CC#8), send 1, or 2 data has been recorded, the settings will change accordingly.

**MIDI** If **Status** (2-1a) is either INT or BTH, CC#8, CC#93, and CC#91 can be received to control the pan following the insert effect, send 1, or send 2 respectively, and change their settings. When you switch songs or return to the beginning of the song, tracks whose **Status** is BTH, EXT, or EX2 will

transmit these settings via MIDI. This data will be transmitted on the MIDI channels specified in the IFX 1-12 pages (8-7).

#### IFX1

- IFX1** [000...185]
- IFX1 On/Off** [Off, On]
- Chain to** [IFX2...IFX12]
- Chain** [Off, On]
- Pan(CC#8) (Post IFX PanCC#8)** [L000...C064...R127]
- Bus Sel. (Bus Select)** [L/R, 1...4, 1/2...3/4, Off]
- Ctrl Bus (FX Control Bus)** [Off, 1, 2]
- REC Bus** [Off, 1, 2, 3, 4, 1/2, 3/4]
- Send1** [000...127]
- Send2** [000...127]

*Note:* You can use the control surface to control Send 1 and 2. For more information, please see “Send1 (MFX1)” on page 490.

#### IFX2...12

These parameters specify the type of each insert effect, its on/off status, chaining, and post-IFX mixer settings. With the exception of **Chain to** and **Chain**, the parameters are the same as for IFX1. For more information, please see “IFX1” on page 137.

<b>IFX2: Chain to</b>	<b>[IFX3...IFX12]</b>
<b>IFX3: Chain to</b>	<b>[IFX4...IFX12]</b>
<b>IFX4: Chain to</b>	<b>[IFX5...IFX12]</b>
<b>IFX5: Chain to</b>	<b>[IFX6...IFX12]</b>
<b>IFX6: Chain to</b>	<b>[IFX7...IFX12]</b>
<b>IFX7: Chain to</b>	<b>[IFX8...IFX12]</b>
<b>IFX8: Chain to</b>	<b>[IFX9...IFX12]</b>
<b>IFX9: Chain to</b>	<b>[IFX10...IFX12]</b>
<b>IFX10: Chain to</b>	<b>[IFX11...IFX12]</b>
<b>IFX11: Chain to</b>	<b>[(IFX12)]</b>

- **0: Memory Status.** For more information, see “Memory Status” on page 624.
- **1: Exclusive Solo.** For more information, see “Exclusive Solo” on page 147.
- **2: Copy Insert Effect.** For more information, see “Copy Insert Effect” on page 159.
- **3: Swap Insert Effect.** For more information, see “Swap Insert Effect” on page 159.
- **4: Insert IFX Slot.** For more information, see “Insert IFX Slot” on page 658.
- **5: Cut IFX Slot.** For more information, see “Cut IFX Slot” on page 658.
- **6: Clean Up IFX Routings.** For more information, see “Clean Up IFX Routings” on page 658.
- **7: Put Effect Setting To Track.** For more information, see “Put Effect Setting to Track” on page 658.
- **8: FF/REW Speed.** For more information, see “FF/REW Speed” on page 625.
- **9: Set Location (for Locate Key.)** For more information, see “Set Location (for Locate Key)” on page 626.

▼ **8-5: Page Menu Commands**

The number before each command shows its ENTER + number-key shortcut. For more information on these shortcuts, see “ENTER + 0-9: shortcuts for menu commands” on page 147.

**8-6: Track View**

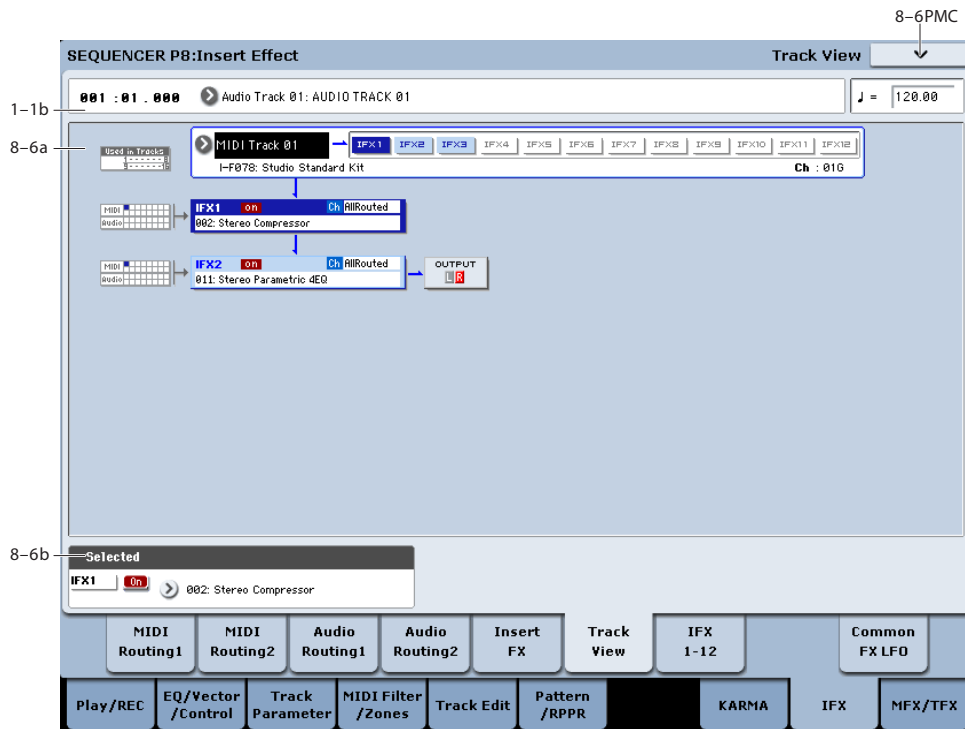

**8-6a: Track View**

Here you can view the track output and insert effect routing.

**Used in Tracks**

The upper and lower rows of boxes with eight boxes in each row indicate the timbre that is being sent to the corresponding insert effect.

- The eight upper boxes correspond to MIDI tracks 1-8, and the eight lower boxes correspond to MIDI tracks 9-16.)
- The eight upper boxes correspond to audio tracks 1-8, and the eight lower boxes correspond to audio tracks 9-16.)

**Track Select [Timbre 01...Timbre 16]**

Here you can select the MIDI tracks 1–16 and audio tracks 1–16 that will be shown in the Track View screen.

The screen shows the insert effect(s) used by the selected track.

**Slot [IFX1...IFX12]**

This indicates the slot number, effect type, effect on/off status, and control channel for the chained insert effects.

The selected slot is shown in dark blue. In the “Selected” area below, you can specify the “Effect Type” and “On/Off” status of the selected effect slot. This is also the effect slot that will be affected by the page menu commands “Insert IFX Slot” and “Cut IFX Slot.”

When you move from this page to the P8– IFX1-12 page, the IFX you selected here will be selected.

For example, if you select Track 03, only the insert effects used by track 3 will be shown.

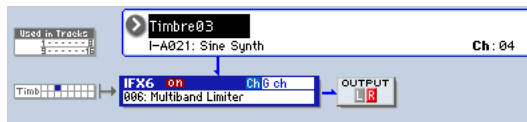

“OUTPUT” indicates the Bus Select settings that follow the insert effect. This tells you the output destination to which the audio signal will be sent.

**8-6b: Selected**

Here you can specify the “Effect Type” and “On/Off” status of the insert effect slot selected by Track Select. (“8-6a: Track View,” above)

**▼ 8-6: Page Menu Commands**

The number before each command shows its ENTER + number-key shortcut. For more information on these shortcuts, see “ENTER + 0-9: shortcuts for menu commands” on page 147.

- 0: **Memory Status.** For more information, see “Memory Status” on page 624.
- 1: **Exclusive Solo.** For more information, see “Exclusive Solo” on page 147.
- 2: **Copy Insert Effect.** For more information, see “Copy Insert Effect” on page 159.
- 3: **Swap Insert Effect.** For more information, see “Swap Insert Effect” on page 159.
- 4: **Insert IFX Slot.** For more information, see “Insert IFX Slot” on page 658.
- 5: **Cut IFX Slot.** For more information, see “Cut IFX Slot” on page 658.
- 6: **Clean Up IFX Routings.** For more information, see “Clean Up IFX Routings” on page 658.
- 7: **Put Effect Setting To Track.** For more information, see “Put Effect Setting to Track” on page 658.

## 8-7: IFX 1-12

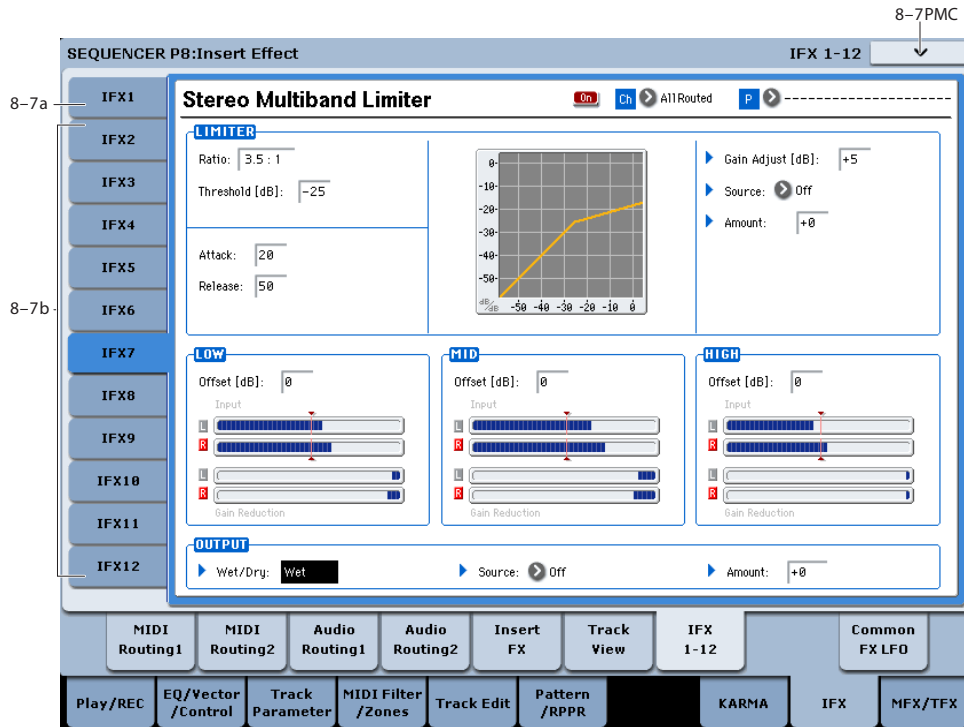

This page lets you edit the detailed parameters of the twelve insert effect s. Use the tabs at left to select IFX1 through IFX12.

To select different effects types, use the Insert FX or Track View pages. For more information, see “8-5: Insert FX” on page 615 and “8-6: Track View” on page 616.

### Effects Modulation: Dmod

Most effects have one or more parameters which can be modulated in realtime. In the KRONOS, this is called Dynamic Modulation, or Dmod for short.

For a complete list of Dmod sources, see “Dynamic Modulation Source List” on page 1101.

**MIDI** You can use different MIDI channels to control Dmod for each effect, if desired, as selected by the **Ch (Control Channel)** parameter.

### 8-7a: IFX1

Here you can edit the effect parameters of the insert effect you selected in the P8- Insert FX page. Use the tabs at left to select IFX1 through IFX12.

#### IFX1 On/Off [Off, On]

Turns the insert effect on/off. This is linked with the on/off setting in the P8- Insert FX page.

#### Ch (Control Channel)[Ch01...16, All Routed]

This parameter specifies the MIDI channel that will be used to control effect dynamic modulation (Dmod), pan following the insert effect (CC#8), Send 1, and Send 2.

The channel number of the MIDI track routed through this IFX will be followed by a “\*” displayed at the right of Ch01-16. If two or tracks with different MIDI channel settings are routed through the same IFX, this parameter specifies which of these channels will be used to control the effect.

*Note:* If you want to control an IFX to which an audio track is routed, use a MIDI track whose channel matches the “Ch (Control Channel)” of the effect you want to control.

**All Routed:** The channel of any MIDI track routed through this effect can be used to control the effect. (Channels of each routed track will be indicated by “\*”).

### Drum Kits and the MIDI Control Channel

If a Timbre is using a Drum Kit, and the Timbre’s **Bus Select (IFX/Indiv. Out Assign) DKit** (8-1b) is enabled, this affects the MIDI Control Channel as well. In this case, the Timbre’s MIDI channel will be used to control any effect whose **Ch** is set to All Routed, regardless of the **Bus Select** (Global 5-3b) settings or the settings of the **DrumKit IFX Patch** page menu command.

#### P (Effect Preset) [P00, P01...15, U00...15, -----]

Effect Presets let you easily store and recall all of the settings for an individual effect. You can store up to 16 user presets for each effect type, in addition to 15 re-writable factory presets.

The same presets appear in all of the modes (Program, Combi, Sequence, and Sampling), and sets of presets can be saved to and loaded from disk.

Note that edits to effects parameters are automatically stored with the Song—you don't need to store them as an Effect Preset. Presets just make it easier to re-use your favorite settings.

For instance, you can save an Effect Preset while working on a particular Song, and then later use the same Effect Preset in a different Program, Combi, or Song.

**P00: Initial Set:** These are the default settings that are recalled when you select an effect type in the Insert FX page. You can't save your own settings here.

**P01...P15:** These contain Korg preset data. We recommend that you store your settings in U00-U15.

**U00...U15:** These are areas in which you can store your own settings.

-----: This shows that no Effect Preset has been selected. You'll see this if you've just selected an effect, written a program, or selected a new Song. Selecting this setting from the menu will not have any effect.

**Note:** Songs save the effects parameter settings, but they don't save the number of the selected Effect Preset. If you select an Effect Preset, save the Song to disk, and then re-load the Song, the Effect Preset setting will revert to "-----."

For more details, see "Using Effect Presets" on page 141.

### IFX1 Parameters

Here you can set the effect parameters of the insert effect you chose in the P8- Insert FX page.

For more details, please see "Insert Effects (IFX1...IFX12)" on page 864.

---

### 8-7b: IFX2...12

Here you can set the effect parameters of the insert effects selected in the Insert FX page.

The parameters for IFX2 through IFX12 are the same as for IFX1. For more information, please see "8-7a: IFX1" on page 618.

---

### ▼ 8-7: Page Menu Commands

The number before each command shows its ENTER + number-key shortcut. For more information on these shortcuts, see "ENTER + 0-9: shortcuts for menu commands" on page 147.

- 0: **Memory Status.** For more information, see "Memory Status" on page 624.
- 1: **Exclusive Solo.** For more information, see "Exclusive Solo" on page 147.
- 2: **Copy Insert Effect.** For more information, see "Copy Insert Effect" on page 159.
- 3: **Swap Insert Effect.** For more information, see "Swap Insert Effect" on page 159.
- 4: **Write FX Preset.** For more information, see "Write FX Preset" on page 163.
- 5: **Put Effect Setting To Track.** For more information, see "Put Effect Setting to Track" on page 658.
- 6: **FF/REW Speed.** For more information, see "FF/REW Speed" on page 625.
- 7: **Set Location (for Locate Key.)** For more information, see "Set Location (for Locate Key)" on page 626.

## 8–9: Common FX LFO

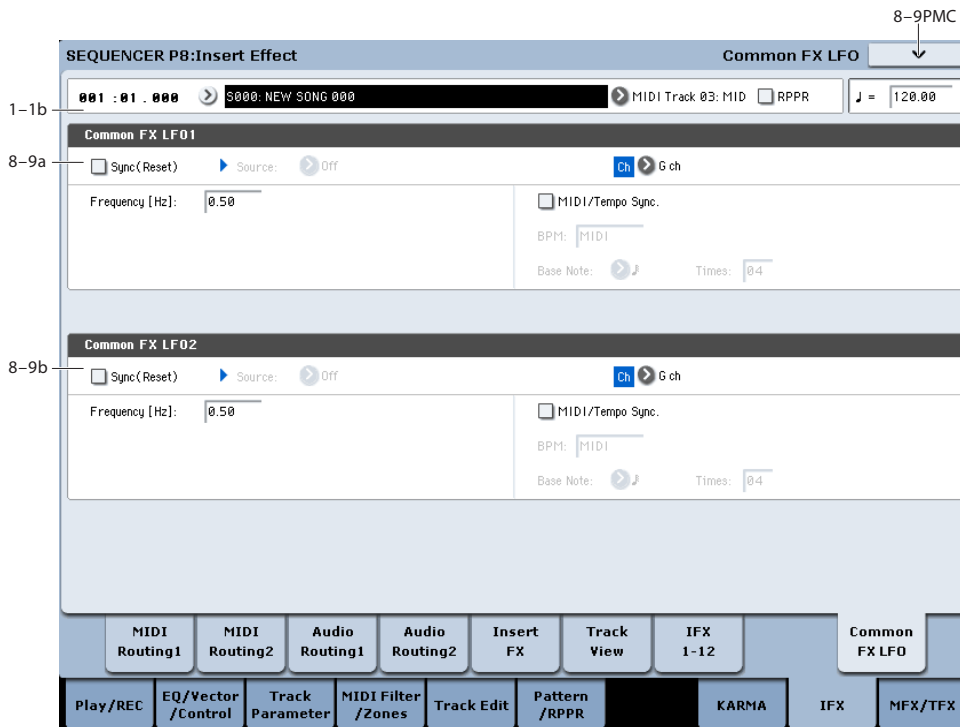

The two Common FX LFOs allow you to synchronize LFO-based modulation for multiple effects, such as phasers, flangers, filters, and so on.

The Common LFOs control only the frequency, MIDI synchronization, and reset options; each individual effect still has its own settings for the LFO waveform and phase.

Within the individual effects, you can choose whether to use one of the Common LFOs, or to use the individual effect’s frequency, sync, and/or reset settings instead. This is done via the effect’s **LFO Type** parameter; select **Individual** to use the effect’s settings, or **Common 1** or **2** to use the Common LFOs.

### 8–9a: Common FX LFO1

**Ch (Control Channel)** [Ch01...Ch16, Gch]

Specifies the MIDI channel that will control dynamic modulation (Dmod) for Common LFO 1 and 2.

**G ch:** The global **MIDI channel** (Global 1–1a) will be used for control. This is the default setting.

**Sync (Reset)** [Off, On]

**Source (Dmod Source)** [List of Dmod Sources]

**Frequency** [0.02...20.00 (Hz)]

**MIDI/Tempo Sync** [Off, On]

**BPM** [MIDI, 40.00...300.00]

**Base Note** [Musical notation icons]

### Times

[01...32]

These parameters are the same as in Program mode. For more information, please see “8–9a: Common FX LFO1” on page 142.

### 8–9b: Common FX LFO2

These parameters are the same as for Common FX LFO1. For more information, please see “8–9a: Common FX LFO1,” above.

### ▼ 8–9: Page Menu Commands

The number before each command shows its ENTER + number-key shortcut. For more information on these shortcuts, see “ENTER + 0-9: shortcuts for menu commands” on page 147.

- **0: Memory Status.** For more information, see “Memory Status” on page 624.
- **1: Exclusive Solo.** For more information, see “Exclusive Solo” on page 147.
- **2: Copy Insert Effect.** For more information, see “Copy Insert Effect” on page 159.
- **3: Swap Insert Effect.** For more information, see “Swap Insert Effect” on page 159.
- **4: Put Effect Setting To Track.** For more information, see “Put Effect Setting to Track” on page 658.
- **5: FF/REW Speed.** For more information, see “FF/REW Speed” on page 625.
- **6: Set Location (for Locate Key.)** For more information, see “Set Location (for Locate Key)” on page 626.



## Sequencer P9: Master/Total Effect

Here you can make settings for the master effects and total effects. For more information, please see “Effect Guide” on page 857.

### 9-1: Routing

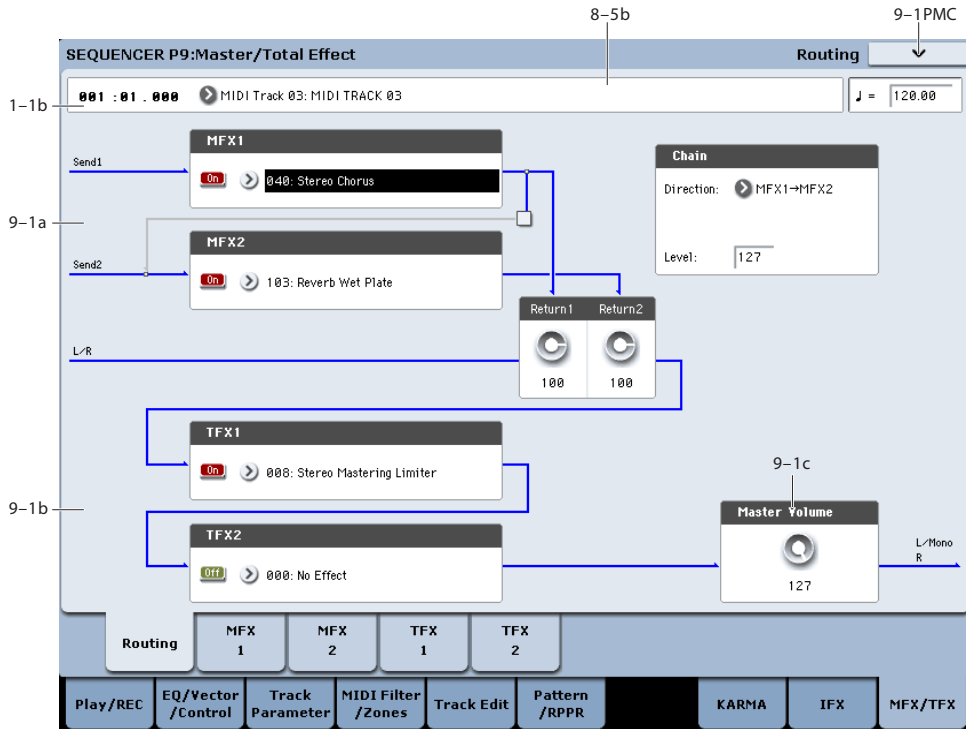

Here you can specify the type of master effects and total effects, and turn them on/off.

The master effects are sent to the L/R bus. The total effects are inserted into the L/R bus.

These parameters are the same as in Program mode. For more information, please see “9-1: Routing” on page 143.

#### 9-1a: MFX1, 2

##### MFX1:

MFX1	[000...185]
MFX1 On/Off	[Off, On]
Return 1	[000...127]

##### MFX2:

MFX2	[000...185]
MFX2 On/Off	[Off, On]
Return 2	[000...127]

#### Chain:

Chain On/Off	[Off, On]
Chain Direction	[MFX1 → MFX2, MFX2 → MFX1]
Chain Level	[000...127]

#### 9-1b: TFX1, 2

##### TFX1:

TFX1	[000...185]
TFX1 On/Off	[Off, On]

##### TFX2:

TFX2	[000...185]
TFX2 On/Off	[Off, On]

#### 9-1c: Master Volume

Master Volume	[000...127]
---------------	-------------

### ▼ 9-1: Page Menu Commands

The number before each command shows its ENTER + number-key shortcut. For more information on these shortcuts, see “ENTER + 0-9: shortcuts for menu commands” on page 147.

- 0: **Memory Status**. For more information, see “Memory Status” on page 624.
- 1: **Exclusive Solo**. For more information, see “Exclusive Solo” on page 147.
- 2: **Copy MFX/TFX**. For more information, see “Copy MFX/TFX” on page 162.

- 3: **Swap MFX/TFX**. For more information, see “Swap MFX/TFX” on page 163.
- 4: **Put Effect Setting To Track**. For more information, see “Put Effect Setting to Track” on page 658.
- 5: **FF/REW Speed**. For more information, see “FF/REW Speed” on page 625.
- 6: **Set Location** (for Locate Key.) For more information, see “Set Location (for Locate Key)” on page 626.

## 9-2: MFX1

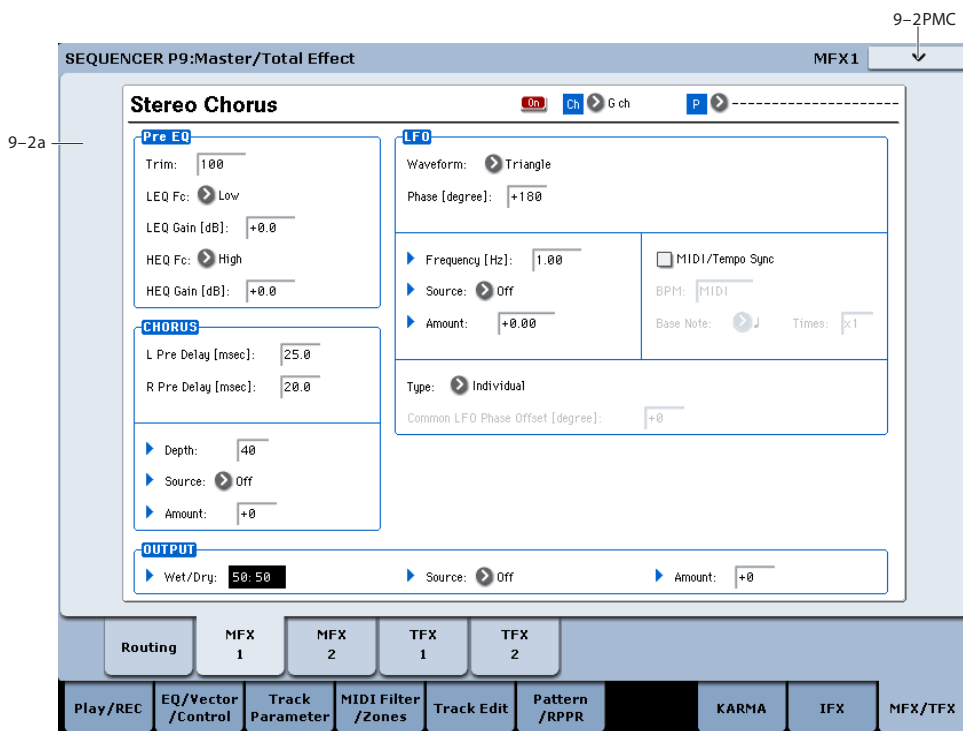

Here you can edit the parameters of the effect you selected for MFX1 in the P9- Routing page.

### Effects Modulation: Dmod

Most effects have one or more parameters which can be modulated in realtime. In the KRONOS, this is called Dynamic Modulation, or Dmod for short.

For a complete list of Dmod sources, see “Dynamic Modulation Source List” on page 1101.

**MIDI** You can use different MIDI channels to control Dmod for each effect, if desired, as selected by the **Ch (Control Channel)** parameter.

### 9-2a: MFX1

**MFX1 On/Off** [Off, On]

This turns master effect 1 on/off. This is linked with the on/off setting in the P9- Master/Total Effect - Routing page.

**Ch (Control Channel)** [Ch01...16, G ch]



Specifies the MIDI channel that will control dynamic modulation (Dmod) for the master effect.

**Ch01...Ch16:** The specified MIDI channel will be used for control.

**G ch:** The global **MIDI Channel** (Global 1-1a) will be used for control. Normally you will use the G ch setting.

**P (Effect Preset)** [P00, P01...15, U00...15, -----]

This lets you select presets for the current effect. For more information, please see “P (Effect Preset)” on page 618.

### MFX1 Parameters

Here you can set the effect parameters of the effect you chose in the P9-Routing page.

For details on the individual effects, please see the “Effect Guide” on page 857.

---

### ▼ 9–2: Page Menu Commands

The number before each command shows its ENTER + number-key shortcut. For more information on these shortcuts, see “ENTER + 0-9: shortcuts for menu commands” on page 147.

- 0: **Memory Status**. For more information, see “Memory Status” on page 624.
- 1: **Exclusive Solo**. For more information, see “Exclusive Solo” on page 147.
- 2: **Copy MFX/TFX**. For more information, see “Copy MFX/TFX” on page 162.
- 3: **Swap MFX/TFX**. For more information, see “Swap MFX/TFX” on page 163.
- 4: **Write FX Preset**. For more information, see “Write FX Preset” on page 163.
- 5: **Put Effect Setting To Track**. For more information, see “Put Effect Setting to Track” on page 658.
- 6: **FF/REW Speed**. For more information, see “FF/REW Speed” on page 625.
- 7: **Set Location** (for Locate Key.) For more information, see “Set Location (for Locate Key)” on page 626.

---

## 9–3: MFX2

---

### 9–4: TFX1

---

### 9–5: TFX2

These pages let you edit the parameters of Master Effect 2 and Total Effects 1 and 2. To select different effects types, use the P9– Routing page.

The parameters of MFX2, TFX1, and TFX2 are the same as for MFX1. For more information, please see “9–2: MFX1” on page 622.

## Sequencer: Page Menu Commands

### Memory Status

If you select “Memory Status,” the remaining amount of sequencer memory will be displayed.

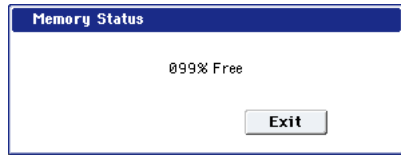

### Exclusive Solo

This specifies how the Solo function will operate. Each time you select “Exclusive Solo,” the setting will alternate between multiple solo and exclusive solo. For details, see “Exclusive Solo” on page 147.

### Rename Song

Here you can rename the selected song. You can enter a name of up to 24 characters. For more information, see “Editing names” on page 184 of the Operation Guide.

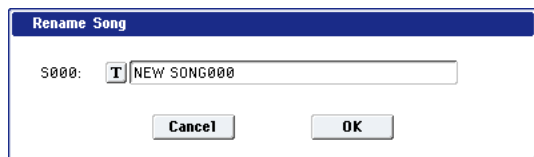

### Initialize Song

This command erases all data in the current song, and restores all parameters to their default states. It's convenient for clearing Song locations if you receive the “Not enough song locations available” error message.

WAV files and their regions will not be deleted. If you want to delete this data, use the **Delete Unused WAV Files** command. For more information, see “Delete Unused WAV Files” on page 852.

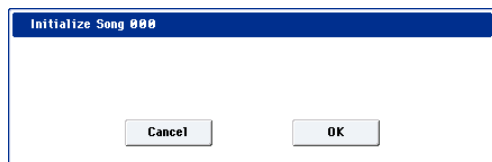

### Copy From Song

This command copies all of the setting data and musical data from the specified song to the currently selected song.

1. Select “Copy From Song” to open the dialog box.



2. In “From,” specify the copy source song number.
3. Select the data that you wish to copy.

**All:** will copy all setting data and musical data (track events and audio events, etc.).

**Without Track/Pattern Events:** will copy only the setting data of songs, except for Play Loop and RPPR data.

4. To execute the Copy Song operation, press the OK button. To cancel, press the Cancel button.

Be aware that if you execute “All,” all setting data and musical data of the currently selected song will be erased and rewritten by the data from the copy source song.

If you execute “Without Track/Pattern Events,” song setting data other than Play Loop and RPPR will be rewritten.

### Load Template Song

Template Songs store pretty much everything in the Song except for the MIDI and audio data itself. This includes Program selections, track parameters, effects and KARMA settings, and the Song's name and tempo.

The factory preset Template Songs let you get up and running quickly with matched sets of sounds and effects for various styles of music. You can also create your own Template Songs with your favorite sounds and setups.

Note that Template Songs do not include the MIDI data for song tracks and patterns, audio data, or settings that govern how the musical data is played back, including **Meter**, **Metronome**, **PLAY/MUTE**, and **Track Play Loop** (including Start/End measure).

While loading a Template Song, you can also optionally load one or more Drum Track patterns.

1. Select “Load Template Song” to open the dialog box.



2. In “From,” specify the Template Song that you wish to load.
3. If you check “Copy Pattern to Track too?,” the “Copy Pattern To Track” dialog box will appear automatically after “Load Template Song” has been executed.

If you execute without checking this, only the template song you specified in step 2 will be loaded.

4. **To load the Template Song, press the OK button. To cancel without loading, press the Cancel button.**

When you execute, song settings other than Play Loop and RPPR will be copied.

If in step 3 you checked “Copy Pattern to Track too?” and pressed the OK button, the “Copy Pattern To MIDI Track” dialog box will appear.

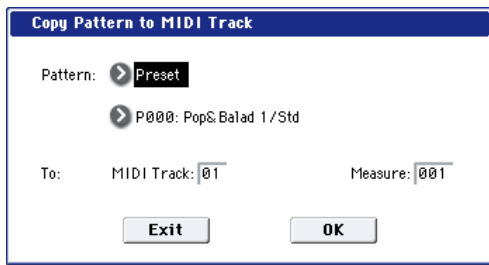

This dialog box is the same as in the page menu command “Copy To MIDI Track”.

5. **In Pattern, select the pattern that you wish to copy. In To Track, select the copy destination track.**

In **Measure**, specify the beginning measure of the copy destination.

*Note:* In each of the preset Template Songs, track 1 is always assigned to a Drum Program. (In some cases, other tracks may also have Drum Programs.)

Following the names for each of the preset patterns, the musical style and the name of the most suitable Drum Programs are partially displayed. (Refer to the VNL for a complete list of Drum Programs.)

By loading a drum track and the corresponding preset pattern, you can instantly set up a Drum Track to match the Template Song.

6. **To execute, press the OK button.**

When you execute, **Measure** will count up automatically. You may then copy patterns as well. To exit the command, press the **Exit** button.

For details on how to copy preset patterns to a song along with the preset template song, see “Template Songs” on page 77 of the Operation Guide.

## Save Template Song

This command saves the program selections, track parameters, effect settings, KARMA settings, and the name and tempo of the current song as a user template song U00–15.

Note that this does not include the MIDI data for song tracks and patterns, audio data, or settings that govern how the musical data is played back, including **Meter**, **Metronome**, **PLAY/MUTE**, **Track Play Loop** (including Start/End measure), and RPPR settings.

1. **Select “Save Template Song” to open the dialog box.**

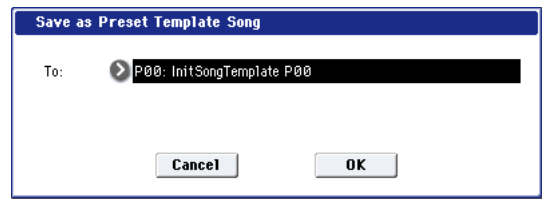

2. **In “To,” specify the user template song (U00–15) in which the data will be saved.**
3. **To save the template song, press the OK button. To cancel, press the Cancel button.**

Note that this will over-write the selected template; be careful not to erase data that you’d like to keep!

## FF/REW Speed

This allows you to set the speed at which fast-forward or rewind will occur when you press the FF switch or REW switch.

- ⚠ Audio tracks will not produce sound during fast-forward or rewind.

1. **Select “FF/REW Speed” to open the dialog box.**

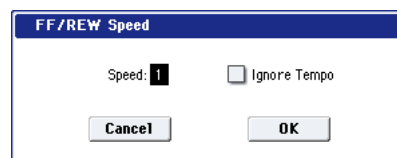

2. **In “Speed,” specify the speed (relative to the playback tempo) at which fast-forward and rewind will occur.**

This setting is in multiples of the playback tempo. A setting of 1 is the same speed as the playback tempo. Settings of 2–4 respectively correspond to double, triple, or quadruple speed of the playback tempo.

*Note:* Fast-forward and rewind speeds may be slower in areas where the performance data is dense.

3. **If “Ignore Tempo” is checked, the playback tempo and note length will be ignored, and fast-forward and rewind will be performed as fast as possible.**

The speed of fast-forward and rewind will differ between sections where the playback data is dense and sections where it is sparse.

If this item is unchecked, fast-forward and rewind will be performed at the speed you specify for “Speed.”

4. **To execute the settings, press the OK button. To cancel, press the Cancel button.**

## Set Location (for Locate Key)

This sets the Sequencer's locate point. When you press the LOCATE switch, the Song will move to the measure, beat, and tick specified here.

1. Select Set Location to open the dialog box.

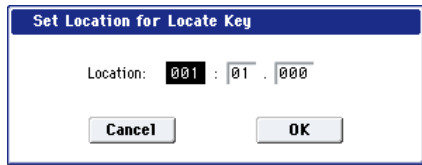

2. Specify the location to which the Song will move when you press the LOCATE switch.

From the left, the values are Measure (001–999), Beat (01–16), and Tick (000–191).

If you set this to 001:01.000, pressing LOCATE brings you back to the beginning of the song.

3. To execute the settings, press the OK button. To cancel, press the Cancel button.

*Note:* When this dialog box is not open, you can hold down the ENTER switch and press the LOCATE switch to set the current location as the locate point.

## GM Initialize

This command transmits a GM System On message to the Sequencer mode, resetting all MIDI tracks to the GM settings (See “GM Initialize menu command - Automatically-set parameters and their values” on page 627).

1. Select “GM Initialize” to open the dialog box.

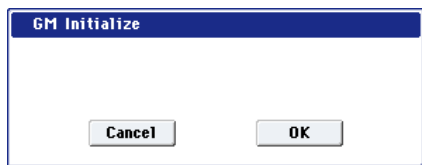

2. To execute the settings, press the OK button. To cancel, press the Cancel button.

**MIDI** In Sequencer mode, when a GM System On message is received from an external device, or if a GM System On message is recorded in the sequence data, the KRONOS will be reset to settings appropriate for GM just as if you had executed this command. However, in these cases, the various P9: Master/Total Effect parameters will not be reset.

## Copy from Combination

This command copies the parameters of the specified combination to the setting data of the currently selected song.

*Note:* Only the timbres used by the combination will be copied. Timbres in the combination whose Status is Off will not be copied. If any timbres are set to Mute, the corresponding tracks of the song will be set to a **Status** of Off. However if none of the timbres used in the combination have a MIDI channel setting of Gch, a MIDI track whose MIDI channel is Gch will automatically be specified, and that track will be

selected in Track Select. After the copy is executed, you will immediately be able to play in the same state as that combination.

1. Select “Copy from Combination” to open the dialog box.

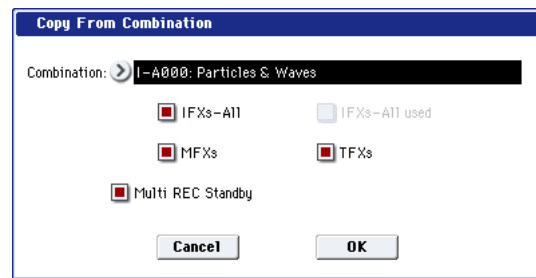

2. In “Combination,” select the copy source destination.
3. Use the IFX-All, IFX-All used, MFXs and TFXs check boxes to specify whether you want the effect settings of the combination to be copied as well.

**IFX-All:** All insert effect settings of the copy-source combination (the contents of the Insert FX page and the IFX1–12 effect parameters) will be copied.

**IFX-All used:** Only the insert effects that are used by the copy-source combination will be copied. When copied, they will be packed into unused slots (000: No Effect, unless within a chain).

*Note:* Copy-source insert effects that are set to 000: No Effect will not be copied. However if 000: No Effect is included within a chain, it will be copied.

If an entire chain in the copy-destination consists of 000: No Effect, it will be used as a copy-destination.

**MFXs:** All master effect settings of the copy-source combination will be copied.

**TFXs:** All total effect settings of the copy-source combination will be copied.

4. Specify the desired Multi REC Standby setting.

**On:** The Status will automatically be set to REC for MIDI tracks corresponding to valid timbres in the copy-source combination. In addition, “Multi REC” (0–1a) will automatically be turned on, and **Recording Setup** (0–5a) will be set to Overwrite.

5. To execute the Copy operation, press the OK button. To cancel, press the Cancel button.

## Copy From Program

This command copies settings from the program you specify to the currently selected song.

This is the same function as in Combination mode; for details, see “Copy From Program” on page 501.

This command in Sequencer mode differs from its behavior in Combination mode in that the channels assigned to the tracks of the song will be preserved regardless of the “with KARMA” setting of the copy-destination track’s “MIDI Channel.” (See step 4.)

**GM Initialize menu command - Automatically-set parameters and their values**

	Page	Parameter	MIDI Track 1-9, 11-16	Track 10	
P0	MIDI Prog/Mixer	Program Select	G001	g(d)001	
		Play/Mute, Solo	-	-	
		Pan	C064	C064	
		Volume	100	100	
P1	MIDI Track EQ	Auto Load Prog EQ	On	On	
		Bypass	On	On	
		Input Trim	99	99	
		High Gain	+00.0	+00.0	
		Mid Frequency	3.20k	3.20k	
		Mid Gain	+00.0	+00.0	
		High Gain	+00.0	+00.0	
P2	MIDI	Status	-	-	
		MIDI Channel	-	-	
		Bank Select MSB/LSB	000	000	
		Timbre Priority	Off	Off	
	OSC	Force OSC Mode	-	-	
		OSC Select	-	-	
		Portamento	Off	Off	
	Pitch	Transpose	+00	+00	
		Detune	+0000	+0000	
		Bend Range	PRG	PRG	
		Use Program's Scale	-	-	
	Delay	Mode	Time	Time	
		Time	0000	0000	
	WSEQ/KARMA	WS Key Sync	PRG	PRG	
		WS Swing	PRG	PRG	
		WS Quantize Trigger	PRG	PRG	
KARMA Track On/Off		Nrm	Nrm		
P3	MIDI Filter Keyboard Zones Vel Zone		On	On	
			C-1...G9 (Slope=000)	C-1...G9	
			001...127 (Slope=000)	001...127	
P7	KARMA	All parameters			-
P8	MIDI Routing1	IFX/Indiv.Out Assign	L/R	L/R	
		Send1	0	0	
		Send2	40	40	
	MIDI Routing2	FX Control Bus	Off	Off	
		REC Bus	Off	Off	
	Insert FX	IFX1...12		-	
		Pan(CC#8)			-
		REC Bus			-
		FX Control Bus			-
		Send1/2			-
Other parameter				-	
Common LFO	All parameters				-
P9	Routing	MFX1			Stereo Chorus
		MFX2			Reverb Smooth Hall
		Chain			Off
		Chain Direction			1->2
		Level			127
		Return1			127
		Return2			50
	Other MFX parameters				-
	TFX1/2				-
Master Level				-	



## Stereo Pair

This lets you assign adjacent audio tracks as a stereo pair. The following parameters of paired channels will be linked with the same values.

Volume, Pan, Send1, Send2, EQ (Bypass, Input Trim, Low Gain, Mid Cutoff, Mid Gain, High Gain), Play/Rec/Mute

In addition, you can use the P4: Track Edit page menu commands to edit paired tracks simultaneously.

Paired channels are controlled by the odd-numbered knob or slider. Moving the even-numbered knob or slider will not control the channels.

1. Select Stereo Pair to open the dialog box.

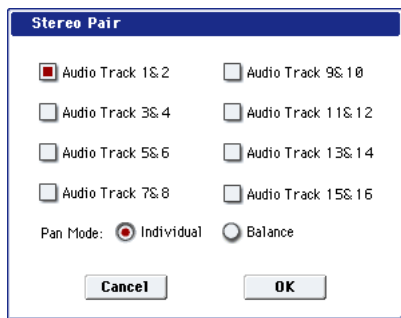

2. Use Audio Track 1&2, 3&4, 5&6, 7&8, 9&10, 11&12, 13&14, and 15&16 to specify the audio tracks that you want to pair.

Uncheck audio tracks that you want to un-pair.

3. Specify the "Pan Mode."

**Individual:** The pan of the two channels will operate independently.

**Balance:** The pan of the two channels will operate as a balance control.

How tracks 1 and 2 behave when paired

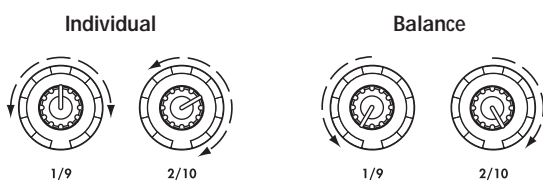

Pan 1 and 2 can be set separately.

If you set pan knob 1 to L000, pan knob 2 will be set to R127. Pan knob 2 has no effect.

4. To apply the changes you made, press the OK button. If you decide to cancel, press the Cancel button.

## Optimize RAM

This command optimizes the RAM memory. When you execute this command, unused memory areas will be reorganized, allowing the full amount of remaining to be used. For more information, see "Optimize RAM" on page 148.

## Select Sample No.

This command specifies the sample number into which samples will be written. You can also specify whether the sample will be automatically converted into a program after sampling, and enable **Auto +12dB**.

*Note:* **Select Sample No.** can be selected if you have chosen RAM for "Save to."

1. Choose Select Sample No. to open the dialog box.

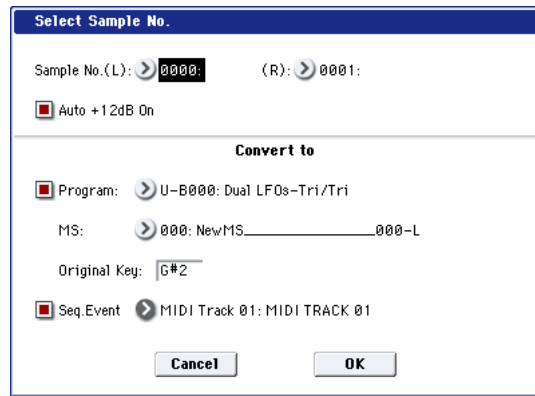

2. In "Sample No.," choose a sample number where the sampling will be performed.

By default, this will be the lowest-numbered of the vacant sample numbers. If you select ----:---No Assign--- or a sample number that already contains data, the sample will automatically be sampled into the lowest-numbered vacant sample number. If you are sampling in stereo, "Sample No.(L)" and "Sample No.(R)" will be created.

3. Set "Auto +12dB On."

**On (checked): +12dB** will automatically be enabled for newly recorded samples. This is the default setting, and if **Recording Level** is set to 0.00 (dB), it means that resampled sounds will play back at the same volume as when they were recorded.

Note that **+12dB** does not change the sample data itself; it only affects the way that the sample is played back.

In general, **+12dB** should be On for drums and loops, and Off for any sounds that you play polyphonically. For more information, see "+12dB" on page 701.

The **Auto +12dB On** setting is made independently for Program, Combination, Sequencer, and Sampling modes.

4. "Convert to" lets you specify whether the sample will automatically be converted to a program after sampling. You can also specify whether a note event will be created at the time of sampling.

If the "Program" check box is **checked**, the sample will automatically be converted to a program.

At the right, use "Program" and "MS" to specify the program number and multisample number of the program that will be created.

**Original Key** (Sampling 0-1b) specifies the location of the original key. The multisample will be created with an **Index** (Sampling 0-1d) having this key as its **Top Key** (Sampling 0-1d). **Original Key** will

increment after sampling, so that the next sample will be assigned to the next higher key.

If you **check** the **Seq.Event** check box, a note event will automatically be created in the track specified by **Track**. Note-on will occur at the location at which sampling began, and note-off will occur at the location at which sampling ended. The note event will be created as in **Recording Setup** Overdub mode (i.e., it will be added without erasing existing events). If you are sampling repeatedly without stopping the song playback, the event(s) will be automatically created when you stop song playback. The "Program Select" (0-1b) of the **Track** you created will automatically will automatically change to the program you specified in "Program." **Seq.Event** is available only if "Program" has been checked.

If you sample with Seq.Event checked in "Convert to," the multisample and samples will be the object of the Compare function. If you want re-do sampling, you can press the COMPARE switch to return the multisample and samples to the state prior to sampling, and unneeded samples will not remain. The program will not be affected by the Compare operation, and will not return to its prior state.

5. Press the OK button to apply the settings you made, or press the Cancel button to discard any settings you made after accessing the dialog box.

### Select Directory/File for Sample to Disk

This command lets you specify the save-destination disk, directory, and filename for the WAVE file that will be created by recording or sampling. It is available when **Save to** is set to Disk.

You can also use the "Select Directory" dialog to audition WAV files directly from the disk.

For more information, see "Select Directory" on page 149.

### Auto HDR/Sampling Setup

This command walks you through making the appropriate settings for various common operations, including hard disk recording, audio track bouncing, sampling/resampling (in-track sampling, etc.), and creating an audio CD. For more information, see "Auto HDR/Sampling Setup" on page 629 of the Parameter Guide.

- When you execute this operation, the relevant parameters will be set automatically. You cannot use the COMPARE switch to revert to the prior settings.
- The settings are automatically made for the most typical applications. After executing the auto setup operation, you can further adjust any of the parameters as described in the paragraphs for each item.

1. Select Auto HDR/Sampling Setup to open the dialog box.

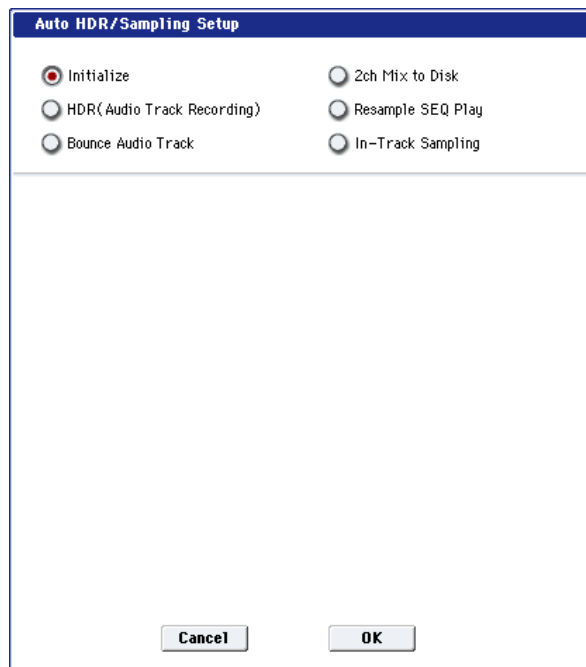

2. Use the radio buttons to select the type of settings you want to make.

**Initialize:** Set parameters related to hard disk recording and sampling to their default values.

**HDR (Audio Track Recording):** Makes the necessary settings for recording external audio signals such as guitar or vocal from the audio inputs to audio tracks.

**Bounce Audio Track:** Makes the necessary settings for bounce-recording audio tracks.

**2ch Mix to Disk:** Makes settings for resampling a completed song in order to create a two-channel stereo WAVE file on the hard disk. (Use this if you want to create a WAVE file and then use the Disk mode Make Audio CD page to burn the file to an audio CD on a USB CD-R/RW drive.)

**Resample SEQ Play:** Makes settings so that you can resample your keyboard playing in Sequencer mode.

**In-Track Sampling:** Makes settings to sample only an external audio signal using the In-Track Sampling function.

3. The settings for the rest of the procedure will depend on what you selected in step 2. (For details, refer to the explanations below.)

**Initialize**

1. Refer to Auto HDR/Sampling Setup steps 1 and 2, and select Initialize.
2. Press the OK button to execute the command. If you decide not to execute, press the Cancel button.  
For more information, see “Auto HDR/Sampling Setup: Automatically-set parameters and their values” on page 634.

**HDR (Audio Track Recording)**

1. Refer to Auto HDR/Sampling Setup steps 1 and 2, and select HDR (Audio Track Recording).
2. Press the OK button to open the dialog box.

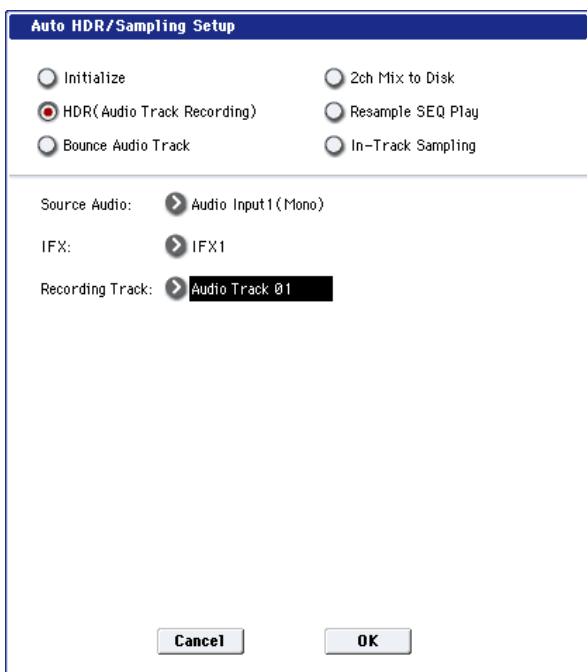

3. In “Source Audio,” select the external audio input source.

If the external audio input source is monaural:

**Audio Input1 (Mono), 2 (Mono):** Selects the analog audio signal from a mic, musical instrument or other device connected to the analog audio inputs.

**S/P DIF L(Mono), R(Mono):** Selects the digital audio signal from an instrument or DAT deck etc. connected to the S/P DIF jack.

**USB 1(Mono), 2(Mono):** Selects the digital audio signal from a computer connected via USB.

If the external audio input source is stereo:

**Audio Input1/2(Stereo):** Selects the stereo analog audio signal from a musical instrument or other device connected to the analog audio inputs.

**S/P DIF L/R(Stereo):** Selects the stereo digital audio signal from an instrument or DAT deck etc. connected to the S/P DIF IN jack.

**USB 1/2(Stereo):** Selects the digital audio signal from a computer connected via USB.

If “Source Audio” is set to S/P DIF, set the **System Clock** appropriately (Global 0–1d).

4. Specify whether you want to apply an insert effect to the input source (i.e., to record the processed signal). Choose the insert effect you want to use. If you don’t want to use an effect, turn this Off.)

*Note:* If you’re using more than one insert effect, make settings for the Insert FX page **Chain** parameters after you execute **Auto HDR/Sampling Setup**. For the last insert effect in the chain, set the **REC Bus** to 1 (for a mono source) or 1/2 (for a stereo source). (At this time, you will normally set **Bus Select** to **Off**—but you don’t have to do so.)

*Note:* You can also record the input source to an audio track without applying an insert effect, and then send the output of the audio track through an insert effect. Make the appropriate **Bus Select** setting in the P8– Audio Routing 1 page for the audio track you recorded.

5. Use “Recording Track” to specify the track(s) that will be recorded.

If “Source Audio” is set to Audio Input 1 (Mono) or 2 (Mono), S/P DIF L (Mono) or R (Mono), or USB 1 (Mono) or 2 (Mono), choose from Audio Track 1–16.

If “Source Audio” is set to Audio Input 1/2 (Stereo), USB 1/2 (Stereo), or S/P DIF L/R (Stereo), choose from Audio Tracks 1&2–15&16. When you execute the command, the “Stereo Pair” setting will be made automatically so that you can record in stereo.

6. Press the OK button to execute the command. If you decide not to execute, press the Cancel button.

For more information, see “Auto HDR/Sampling Setup: Automatically-set parameters and their values” on page 634.

**Recording to the audio track(s) after executing the command**

1. Connect your instrument etc. to the **AUDIO INPUT** jack you selected in “Source Audio,” and use “Audio Track Recording Level” to adjust the recording level.
2. Set “Location” to the location that you want to record.
3. Press the **SEQUENCER REC/WRITE** switch and then the **SEQUENCER START/STOP** switch. (Recording will begin.)
4. Play the musical instrument etc. that is connected to the **AUDIO INPUT** jack(s) you selected for “Source Audio.”
5. When you have finished performing, press the **SEQUENCER START/STOP** switch. (Recording will stop.)

**Check the audio track(s) that you recorded**

- To listen to the audio track you recorded, press the **SEQUENCER START/STOP** switch to play back the track.

## Bounce Audio Track

1. Refer to Auto HDR/Sampling Setup steps 1 and 2, and select Bounce Audio Track.
2. Press the OK button to open the dialog box.

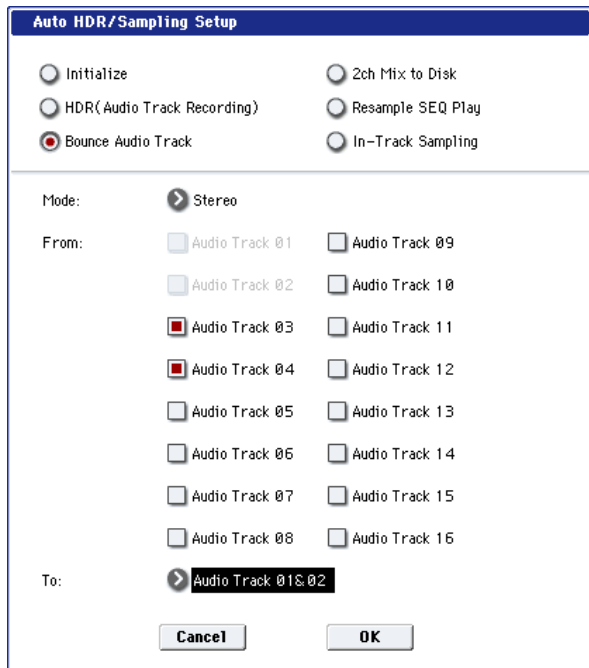

3. Use "Mode" to specify whether you will bounce in mono or in stereo.

**Mono:** Tracks will be bounced to a single audio track. Any stereo information will not be maintained.

**Stereo:** Tracks will be bounced in stereo to two audio tracks.

4. Use "From" to select the source tracks for the bounce.

 If **Mode** is set to Mono, you can bounce up to 15 tracks; if it's set to Stereo, you can bounce up to 14 tracks.

5. Use "To" to select the record track(s).

If **Mode** is set to Mono, choose from Audio Track 1–16.

If **Mode** is set to Stereo, choose from Audio Track 1&2–15&16.

6. Press the OK button to set up the tracks for the bounce.

You can also exit without making any changes, by pressing the Cancel button.

For more information, see "Auto HDR/Sampling Setup: Automatically-set parameters and their values" on page 634.

After completing the steps above, the tracks are set up, and you're ready to record the bounce.

7. Press the SEQUENCER REC/WRITE switch and then the SEQUENCER START/STOP switch.

Only the audio track(s) you selected in "From" will play back, and the bounce recording will begin.

8. When the audio track(s) finish playing back, press the SEQUENCER START/STOP switch.

This completes the bounce. Next, check the recorded results:

9. Turn on SOLO for newly recorded audio track.
10. Press the SEQUENCER START/STOP switch to begin playback.

## Effects are not recorded when bouncing tracks directly

If you don't change the settings after executing the command, the effect settings will be ignored, and the audio from the audio track will be bounced directly. Even if IFX1 is being applied to the output of Audio Track 1 and 2 as shown below, IFX1 will not be applied to the sound that is recorded on the bounce-destination audio tracks.

Audio Track 01: Guitar 1 → IFX1: Guitar Amp

Audio Track 02: Guitar 2 → IFX1: Guitar Amp

Audio Track 03= Audio Track 01 + Audio Track 02

If you want to apply an effect to the output of audio track 03, use the audio track 03 **Bus Select** parameter to send the output to IFX1.

## An example of changing the settings

- If you want to bounce audio that is processed by an effect, you can do this by changing the **REC Bus** or **REC Source** settings.

If you want to bounce the audio from the audio track after it has been processed by the insert effect and master/total effects, send the post-effect audio to the REC Bus, and set the bounce-destination audio track's **REC Source** to REC Bus.

Audio Track 01 → IFX1 → **REC Bus** 1

Audio Track 02 → IFX1 → **REC Bus** 1

Audio Track 03: **REC Source** REC 1

When you bounce, the audio processed by IFX1 will be recorded on audio track 03.

- If you want to bounce audio after it is processed by a total effect, set the bounce-destination audio track's **REC Source** to L/R, and make settings so that the post-effect sound is sent to the bounce-destination audio track.

Audio Track 01 → Solo On → IFX1 → MFX/TFX

Audio Track 02 → Solo On → IFX1 → MFX/TFX

Audio Track 03: **REC Source** L

When you bounce, the audio processed by IFX1 and MFX/TFX will be recorded on audio track 03.

## 2ch MIX to Disk

1. Refer to Auto HDR/Sampling Setup steps 1 and 2, and select 2ch MIX to Disk.
2. Press the OK button to execute the command. If you decide not to execute, press the Cancel button.

For more information, see "Auto HDR/Sampling Setup: Automatically-set parameters and their values" on page 634.

## Making the song into a two-channel (stereo) WAVE file after you execute this command

1. Select the song that you want to resample.
2. Press the SAMPLING REC switch and then the START/STOP switch (Standby).
3. Press the SEQUENCER START/STOP switch.

The song will play back, and resampling will begin at the same moment.

**4. When song playback ends, resampling will stop, and a WAVE file will be created.**

You can also finish the resampling at any time by pressing the SEQUENCER START/STOP switch during playback.

*Note:* Use the **Select Directory/File for Sample to Disk** menu command to specify the location in which the new WAVE file will be created.

**Resample SEQ Play**

**1. Refer to Auto HDR/Sampling Setup steps 1 and 2, and select Resample SEQ Play.**

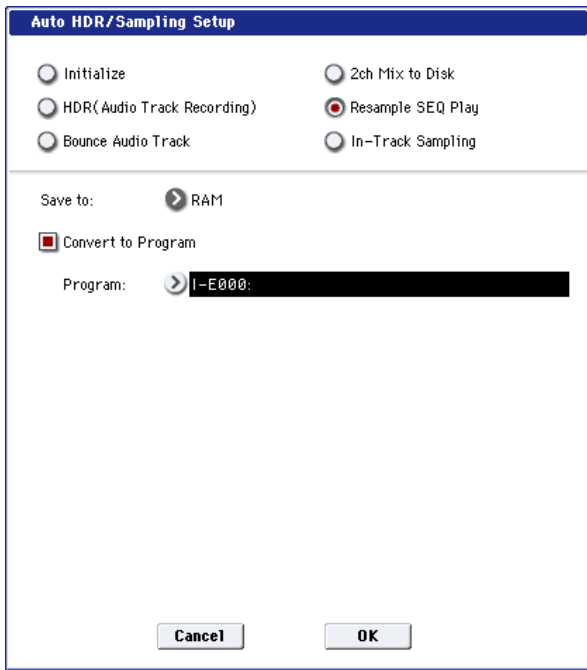

**2. Use "Save to" to select either RAM or DISK as the destination to which the resampled data will be written.**

If you select RAM, the data will be written into Sampling Mode. If you select the DISK setting, a WAVE file will be created from the sampled data and saved to the hard disk.

**3. If you selected "Save to" RAM, you can specify whether the data will be automatically converted to a program after resampling.**

If you want the data to be converted, check "Convert to Program" and use the "Program" field to specify the convert-destination program.

**4. Press the OK button to execute the command. If you decide not to execute, press the Cancel button.**

For more information, see "Auto HDR/Sampling Setup: Automatically-set parameters and their values" on page 634.

**Resampling after you execute this command**

**1. Press the SAMPLING REC switch and then the SAMPLING START/STOP switch, and then play the keyboard etc.**

Since "Trigger" (0-8c) is set to Note On, sampling will begin at the first note-on.

**2. When you've finished playing, press the SAMPLING START/STOP switch to stop resampling.**

*Note:* If you execute Resample SEQ Play with "Save to" RAM and "Convert to Program" checked, you can continue sampling without changing the settings, and the samples will automatically be assigned to C#2, D2, ... and so on. A new multisample will be created when you execute "Resample SEQ Play" once again and sample.

**Auditioning the new sample**

- If you executed with "Save to" RAM and "Convert to Program" checked, select the program you specified as the convert-destination, and play the C2 key to hear the result.

If you didn't check "Convert to Program," use Sampling mode to select and audition the sample.

- If you executed with "Save to" DISK, use the page menu command "Select Directory" to audition the sample.

*Note:* To change the sample number used for sampling (when using "Save to" RAM), use the page menu command **Select Sample No.** If you want to change the save-destination for the WAVE file (when using "Save to" DISK), use the menu command **Select Directory/File for Sample to Disk.**

**An example of changing the settings**

- To change the way in which sampling is initiated, change the "Trigger" setting.
- If you want to simultaneously sample an external audio source from AUDIO INPUT etc. together with your own playing on a program, set the Sampling page Input 1-4 and S/P DIF "Bus (INF/Indiv.) Select" setting to L/R, and the **Source Bus** to L/R.

**If you selected In-Track Sampling:**

**1. Refer to Auto HDR/Sampling Setup steps 1 and 2, and select In-Track Sampling.**

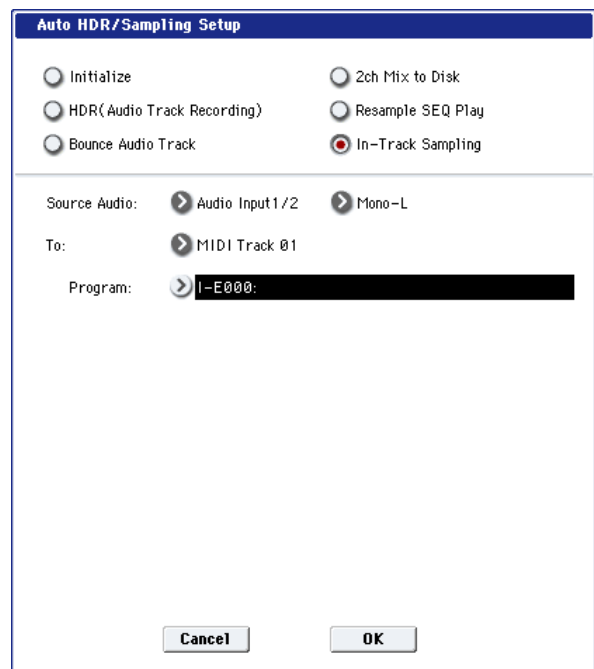



2. Use “Source Audio” to select the external audio input source: analog Audio Input 1/2, S/P DIF, or USB.

3. Use “Mono-L/Mono-R/Stereo” to select the input source and the number of channels you will sample.

Mono-L uses Analog 1, S/P DIF L, or USB 1.

Mono-R uses Analog 2, S/P DIF R, or USB 2.

Stereo uses both channels from the given input.

4. Use the “To” field to select the track that you will use for In-Track Sampling.

Note data will automatically be written to the track you select.

5. Use “Program” to specify the program into which the sample will be converted.

When sampling ends, the entire process of creating a new multisample through converting it to a program and assigning it to a track will be performed automatically.

6. Press the OK button to execute the command. If you decide not to execute, press the Cancel button.

For more information, see “Auto HDR/Sampling Setup: Automatically-set parameters and their values” on page 634.

page and set “Bus (IFX/Indiv.) Select” to IFX1–IFX12. Set the **Bus Select** following the insert effect you’re using to REC 1/2.

- To change the way in which sampling is initiated, change the “Trigger” setting. If you set this to Threshold, resampling will begin the instant the input level exceeds the specified value. Use the page menu command **Select Sample No.** to select the sampling-destination RAM memory.
- If you selected S/P DIF for “Source Audio,” you may also wish to check that the Global **System Clock** parameter is set appropriately. For more information, see “System Clock” on page 756.

### In-Track Sampling after you execute this command

1. Use “Location” to specify the location from which you want the song to play back.

2. Press the SAMPLING REC switch to enter sampling-standby mode.

3. Press the SEQUENCER START/STOP switch to begin playback.

4. At the point where you want to start sampling, press the SAMPLING START/STOP switch. In-Track Sampling will begin.

5. Play the instrument etc. that is connected to the AUDIO INPUT jack you selected as the “Source Audio” setting.

6. When you’re finished playing, press the SAMPLING START/STOP switch to stop only sampling.

If you press the SEQUENCER START/STOP switch, both sampling and song playback will stop.

*Note:* If you continue sampling after executing In-Track Sampling, successive samples will automatically be assigned to C#2, D2, ... etc.

However if you execute Auto Sampling Setup once again and then sample, the samples will be created in a new multisample.

### Auditioning the data you sampled

- Return the “Location,” and then press the SEQUENCER START/STOP switch to play back the song.

Alternatively, use **Track Select** (0–1a) to select the track you specified in “To” (dialog box), and play the C2 key.

### An example of changing the settings

- If you want to apply an insert effect to the input source, go to the Sequencer P0: Audio In/Sampling

**Auto HDR/Sampling Setup: Automatically-set parameters and their values**

		Initialize	HDR (Audio Track Recording)	Bounce Audio Track	2ch Mix to Disk	Resample SEQ Play	In-Track Sampling	
Input (Input Source)*1		Input 1 & 2, USB 1 & 2, S/P DIF L/R	[Source Audio]*2	Input 1 & 2, USB 1 & 2, S/P DIF L/R	Input 1 & 2, USB 1 & 2, S/P DIF L/R	Input 1 & 2, USB 1 & 2, S/P DIF L/R	[Source Audio]*2	
Input 1&2, USB 1&2, S/P DIF L&R*6	Bus Select	Off	[IFX]	Off				
	FX Ctrl Bus	Off						
	REC Bus	Off						1/2
	Send1/2	000						
	Level	127						
Input 1, USB 1, S/P DIF L	Pan	L000						
Input 2, USB 2, S/P DIF R	Pan	R127						
Audio Track	Play/Rec/Mute	Play	[Recording Track]: REC *8	[To][Mode]: REC *8	-	-	-	
	Solo	-	-	[From]: Solo On	-	-	-	
	REC Source	In1	[Source Audio][IFX]*6	REC 1/2 *8	-	-	-	
	Stereo Pair	Off	[Source Audio]*6	[Mode] *8	-	-	-	
Sampling Setup (Name)	Source Bus	L/R	-	-	L/R	L/R	REC1/2	
	Source Direct Solo	(N/A)	-	-	(N/A)	(N/A)	Off	
	Trigger	Note On	-	-	Sequencer START SW	Note On	Sampling START SW	
	Metronome Precount	(N/A)	-	-	(N/A)	(N/A)	-	
	Save to	RAM	-	-	DISK	[Save to]	[Save to]	
	Mode	Stereo	-	-	Stereo	Stereo	[Source Audio]*3	
	Sample Time(RAM)	Maximum	-	-	(N/A)	-	-	
	Sample Time(DISK)	80min?	-	-	-	-	-	
	Rec Level	+0.0	-	-	+0.0	+0.0	+0.0	
Select Sample	Auto +12dB On	On	-	-	-	On *4	On *4	
	Convert to Program	Off	-	-	-	[Convert to Program]*5	[Convert to Program]*5	
	Program	-	-	-	-	[Program]*5	[Program]*5	
	MS	-	-	-	-	(Newly created)*5	(Newly created)*5	
	Original Key	-	-	-	-	(C2)*5	(C2)*5	
	Seq. Event	-	-	-	-	-	On *5	
	MIDI Track	-	-	-	-	-	[To]*5	
Select Directory	-	-	-	-	-	-		
Insert FX	Bus Select (Post IFX)	-	REC1/2(st), REC1(mn)*7	-	-	-	-	

-: Not set automatically

[ ]: Set automatically according to the parameter settings in the dialog box



- \*1 [ ] User Global Setting: Edit Song Parameters  
[x] User Global Setting: Edit Global Parameters
- \*2 The input source specified as Source Audio will be set.
- \*3 L-Mono if the Source Audio is Mono-L, R-Mono if it is Mono-R, and Stereo if it is Stereo
- \*4 When Save to=RAM
- \*5 When Save to=RAM, when Convert to Program=On
- \*6 If IFX=Off, set to [Source Audio]. If Stereo, turn Stereo Pair off.  
If IFX=IFX1...12, set to REC1/2 (Stereo) or REC1 (Mono).
- \*7 If IFX=IFX1...12, specify the Bus Select of that IFX1...12. If effects are chained, specify the last IFX in the chain.
- \*8 If the source audio Mode=Stereo, Multi REC is turned On, and a stereo pair is set to REC as the To track, set the From Track "REC Bus" to REC1/2.

---

## Bounce All Tracks To Disk

This command bounce-records all tracks in the song to a single WAVE file (stereo).

Simply use the dialog box to specify the bounce-recording destination song and the name of the file that will be created, and press the OK button. The WAVE file will be created automatically.

1. Use "Song Select" to select the song you want to bounce.

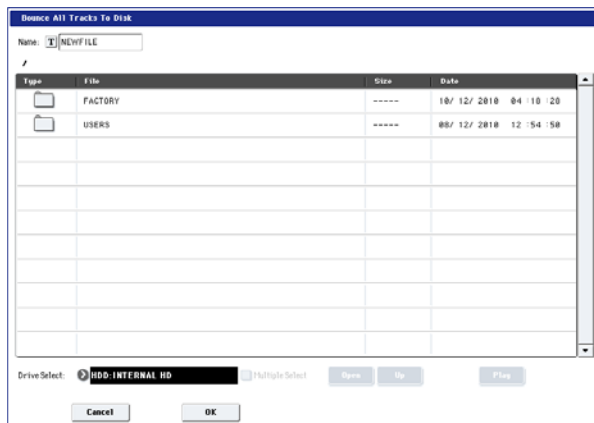

2. Select "Bounce All Tracks To Disk" to open the dialog box.
3. Use "Drive Select," "Open," and "Up" to select the directory in which the WAVE file will be saved.
4. Use "Name" to specify the filename of the WAVE file that will be created by bounce-recording.
5. Press the OK button to execute the command. If you decide to cancel, press the Cancel button.

The bounce-source song will start playing, and recording will begin simultaneously. When song playback ends, bounce-recording will end.

---

## Copy Tone Adjust

For more information, see "Copy Tone Adjust" on page 152.

---

## Reset Tone Adjust

For more information, see "Reset Tone Adjust" on page 153.

---

## Show EQ Graphic

This calls up a floating window, showing a graphic representation of the selected Track's EQ settings. You can leave the window open as you work; as you change EQ settings, or select different Tracks, the graphic will update accordingly.

The window will cover the parameters for some of the Tracks on either the right or left sides of the display. If you select one of these Tracks, the window will automatically move to the other side of the display.

---

## Copy Drum Track

Please see "Copy Drum Track" on page 506.

---

## Erase Drum Track Pattern

**Erase Drum Track Pattern** is available on the Pattern Edit and Pattern Name tabs of the Pattern/RPPR page, as well as the Drum Track page.

This erases the specified drum track pattern.

1. Select **Erase Drum Pattern** to open the dialog box.
2. Select the user drum track pattern you want to erase.
3. If you check **All Drum Track Patterns**, all user drum track patterns will be erased.
4. To execute the **Erase Drum Track Pattern** command, press the OK button. To cancel, press the Cancel button.

---

## Copy Vector Envelope

For more information, see "Copy Vector Envelope" on page 153.

---

## Copy Pad Setup

For more information, see "Copy Pad Setup" on page 154.

---

## Detune BPM Adjust

This command is available on the Pitch tab of the Track Parameters page. This command can be used only when the **Detune** parameter is currently selected; otherwise, the menu selection will be grayed out.

**Detune BPM Adjust** changes the tempo of all loops within a Program by changing the Track's **Detune** parameter. The sample data itself is not altered. Since this alters the pitch of the loop along with the tempo, it's generally suited only to un-pitched percussive loops.

For more information, see "Detune BPM Adjust" on page 504.

## MIDI Step Recording

Step recording allows you to specify the length and velocity of each note numerically, and to input MIDI data, the pitches, from the keyboard. You can also use the on-screen buttons to enter Rests or Ties.

 If you use step recording to input data into a track that already contains sequence data, all data will be erased from the **From Measure** and subsequent measures. If after recording, you decide to revert to the prior data, use the Compare function.

To input data with a continuously-changing value such as pitch bend, it is best to use the "Create Control Data" menu command. To input individual data events such as program changes, use the "MIDI Event Edit" menu command.

1. Use Track Select to select the track into which you wish to input data, and use From Measure (4-1b) to specify the measure at which you wish to begin input.
2. When you select "MIDI Step Recording," the following dialog box will appear.

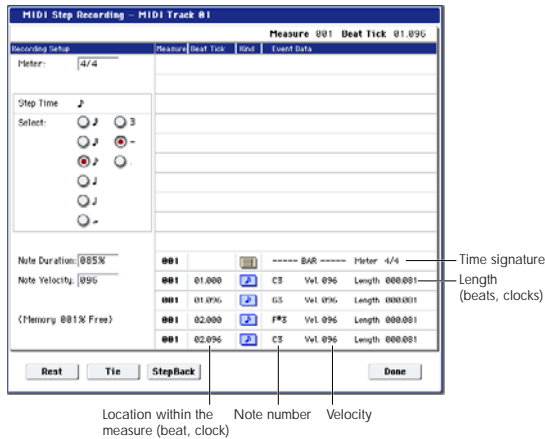

3. In Meter, set the time signature.

This will show the time signature that has already been set for the measure.



















If you change the time signature setting, the time signature data of the measures you record will change, and all tracks will change to the time signature you specified.

4. In "Step Time," specify the length (in terms of a note value) of the basic interval at which you will input data.

From the popup menu at the left, select the note length from between  $\circ$  (whole note) and  $\text{♪}$  (32nd note).

If you want the selected note value to be a dotted note or a triplet, use the popup menu at the right to select a dot "." (Dot) or triplet "3 (Triplet)." To use the unmodified value of the selected note, choose "-" (Normal)."

The following table shows the number of clocks represented by each "Step Time" selection.

 (0:24)	 (0:48)	 (0:96)	 (1:00)	 (2:00)	 (4:00)
 (0:36)	 (0:72)	 (0:144)	 (1:96)	 (3:00)	 (6:00)
 (0:16)	 (0:32)	 (0:64)	 (0:128)	 (1:64)	 (2:128)

5. In "Note Duration," specify the length that the note will actually be held, relative to the "Step Time."

In general, 100% will be tenuto, 85% will be normal, and 50% will be staccato.

6. Use "Note Velocity" to specify the velocity value (keyboard playing strength) of the note data.

With the PAUSE switch pressed, you can hold down the ENTER switch and play a note on the keyboard to specify the velocity value. If you set this to Key, the actual velocity at which you played the key will be input.

7. Input the note events described below by playing notes on the keyboard or by pressing the buttons in the lower part of the dialog box.

- Entering notes

When you press a key on the keyboard, that note number will be input as a note of the length specified in step 4.

When you press a chord on the keyboard, those note numbers will be input as chords of the length specified in step 4. Since each of the note numbers you press before releasing all of the keys will be input at the same location, the notes will be input as a chord even if they are actually played at different times.

Each time you press and release the keyboard, the location will advance by the length specified in step 4.

- Entering rests

Press the Rest button to enter a rest of the length specified in step 4.

- Entering a tie

If you press the Tie button without pressing the keyboard, the previously-input note will be tied, and lengthened by the amount specified in step 4.

If you press the Tie button while holding down a note, the note you are playing will be tied, and lengthened by the amount specified in step 4.

You can even enter notes as shown in the following diagram.

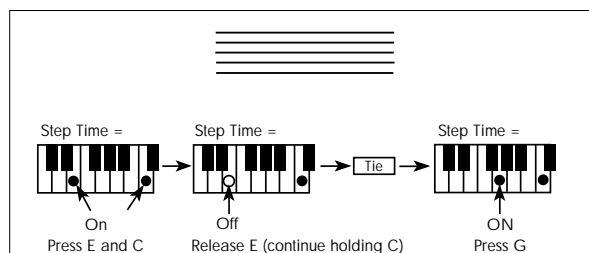

- Deleting a note or rest

To delete a note or rest, press the Step Back button. The location will move backward by the amount specified in step 4, and the data in that interval will be deleted.

- Auditioning the next note before input

If you wish to make sure of the next note before you actually input it, press the PAUSE switch (the LED will light). Now when you press a key, you will hear sound but the note will not be input. Press the PAUSE switch once again (the LED will go dark) to cancel the pause mode and resume input.

**8. When you are finished with step recording, press the Done button.**

If you press the COMPARE switch, you will return to the condition of before you began step recording.

### MIDI Event Edit

Here you can edit individual events of MIDI data that were input.

1. Use Track Select to select the track that you wish to edit
2. Use the From Measure (4-1b) field to specify the measure at which you wish to begin editing.
3. Select the MIDI Event Edit menu command.

If Track Select is set to MIDI Track01-16, the Set Event Filters dialog box will appear.

If Track Select is set to the Master Track, the Event Edit window will appear immediately; Set Event Filters will not appear.



Set Event Filters lets you choose which types of MIDI data will appear in the event edit window. You can use this to focus on one or more specific types of data, or to hide data that you're not interested in at the moment. Only the data which is shown can be edited.

You can choose to view only a specific range of notes, by setting the **Note Bottom** and **Top** as desired. To edit these settings, you can use the standard shortcut: hold ENTER and play a note on the keyboard. Normally, leave these set at the defaults of C-1 and G9.

**Control Change** lets you show only a specific control change number, or ALL controllers (the default).

You can also show or hide **Pitch Bend**, **Program Change**, **After Touch**, **Poly After Touch**, and **Exclusive**.

4. Press the OK button to open the Event Edit dialog box.

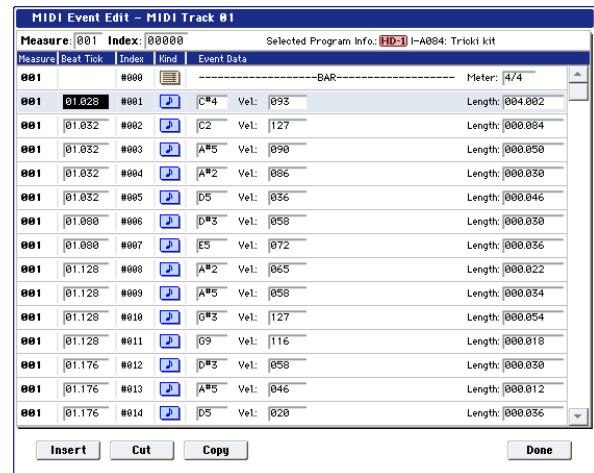

5. In the upper part of the dialog box, Measure and Index show the measure that you are editing and the events of the index numbers within the measure.

You can touch the scroll bar located at the right to move to the event that you wish to edit.

6. Select the event that you wish to edit, and use the VALUE controller etc. to modify its value(s).

By modifying the value of the "Beat Tick" location within the measure, you can move the event within the measure.

You can edit each event by modifying its data value(s). When you select a note event, it will sound.

7. You can press the buttons located at the bottom of the dialog box to edit events as follows.

- Inserting an event

Select the location "Beat Tick" at which you wish to insert an event, and press the Insert button to insert an event.

- Deleting an event

Select the event that you wish to delete, and press the Cut button to delete the event.

- Moving an event

You can use the Cut button and Insert button to move an event (by "cut and paste").

Use the Cut button to delete the event that you wish to move, then use the Insert button to insert it at the desired location.

You can also move an event by modifying its "Beat Tick" value.

- Copying an event

Select the event that you wish to copy, and press the Copy button. Then select the copy destination and press the Insert button to insert the event at that location.

- Playing back an event

When you press the Play button, a dialog box will open and the song will begin playing. Use this to audition the edits you've made in Event Edit.

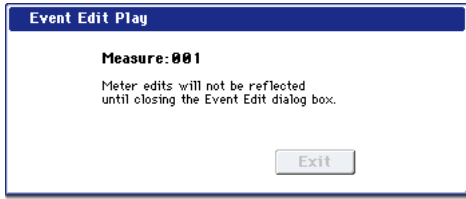

Playback will start from the beginning of the measure that includes the selected event. If there is no selected event, playback will start from the **Measure** setting of the song—just like playback on the P0: Play/REC page.

If you want to hear only the track you're editing, use the Control Surface to solo the track, or to mute other tracks.

Playback will begin from the measure specified by **Measure**.

If you've edited the **Meter**, the change will not be reflected in the playback until you exit Event Edit.

When you press the Exit button, playback will stop and you will return to the Event Edit dialog box.

**8. When you are finished event editing, press the Done button.**

If you press the COMPARE switch you will return the data to the condition in which it was before you began event editing.

The following table shows the types of musical data that can be edited by "MIDI Event Edit" and the range of their values.

BAR (displayed only) (Measure line)	Meter: 1/4...16/16 *1 (Time signature)
C-1...G9 *2 (Note data)	V: 1...127 *2 (Velocity) L: 000.000...15984.000 (Length: beats, clocks)
PAFT (Polyphonic after touch)	C-1...G9 (Note number) 0...127 (Value)
CTRL (Control change)	C: 0...101 (Control change number) 0...127 (Value)
PROG  (Program change)	Bank: I-A...I-F, G, g(1)...g(9), g(d), U-A...U-G, U-AA...U-GG (Program bank) P: 0...127 (all INT and USER banks) 1...128 (G, g(1)...g(d)) (Program number)
AFTT (After Touch)	0...127 (value)
BEND (Pitch bend)	-8192...+8191 (value)
EXCL *3 (Exclusive)	

\*1: Be aware that because the time signature is recorded in the master track, modifying it from any track will affect the same measure of all tracks, causing them all to be played in the modified time signature.

*Note:* \*2: Note data and velocity values can also be entered by holding down the ENTER switch and playing a note on the keyboard.

\*3: You cannot change System Exclusive events into a different type of event (e.g., a Note or Control Change event). Nor can you change any other type of event into a System Exclusive event.

Pattern numbers will be displayed in locations in which a pattern has been "put" (placed). At the end of the track there will be an indication of End of Track.

**Audio Event Edit**

This command lets you edit individual audio events that have been recorded, or trim (i.e., make adjustments in steps of a single sample to) the region used by audio events.

If you want to change the name of a region after recording, use the Select Region dialog box.

*Note:* As long as there is data in the master track, you can open the audio event editing dialog box even if the audio track is empty.

1. Use **Track Select** to select the audio track you want to edit, and use **From Measure (4-1b)** to select the measure at which you want to begin editing.
2. Choose the "Audio Event Edit" command to open the dialog box.

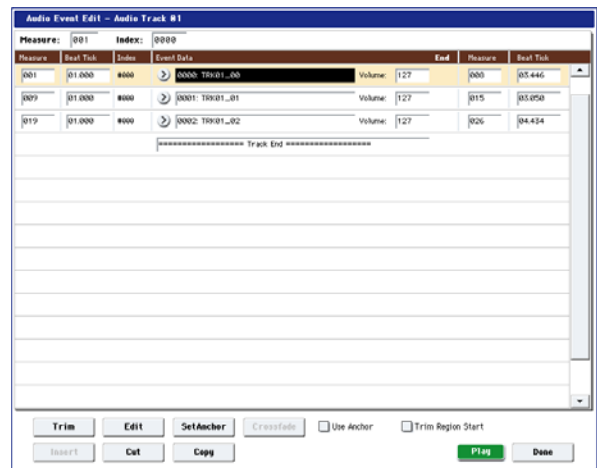

3. **Measure and Index** located in the top line of the dialog box show the measure for editing and the index number of an event within that measure; this event is shown at the top of the list of events.

You can use the scroll bar at right to move to the event you want to edit.

You can select an audio event and press the Play button to hear that event. This is a convenient way to audition your changes.

4. **Select the event you want to edit, and use the VALUE controller to input the desired values.**
  - You can edit the Location **Measure** and "Beat Tick" to move the location of the event. However, you can't place two or more events at the same location.

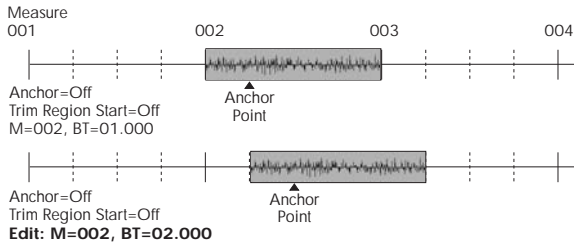

- If you check the “Anchor” check box, the anchor point location will be displayed in **Measure** and “Beat Tick”, and you can specify the location using this anchor point as the reference. This is convenient when a point inside a region needs to be aligned at a specific location.

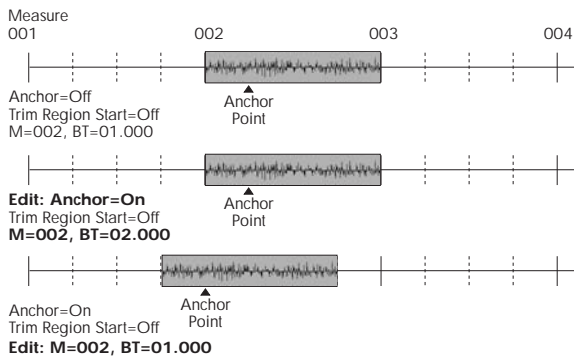

- If you edit the location with “Trim Region Start” checked, the “Start” of the region will also be adjusted simultaneously. Check this box if you want to adjust the length without changing the overall position.

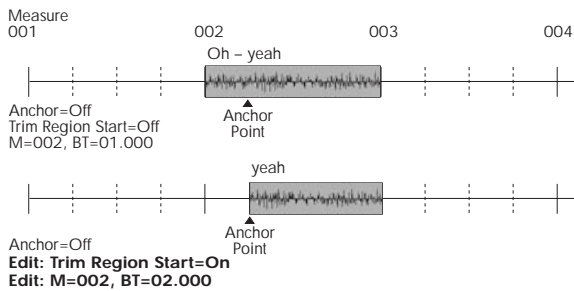

- “V” (Volume) specifies the volume of the audio event.  
*Note:* The volume of an audio track is determined by this volume value multiplied by the volume of the audio track.
- You can edit the end location “E” (Measure. Beat. Tick) to change the location at which the event ends. Editing the end location will change the “End” of the region. However, you can’t set this to a point beyond the length of the WAVE file.

**5. Press the Select Region button to change the region.**

When you press the Select Region button, the Select Region dialog box will appear.

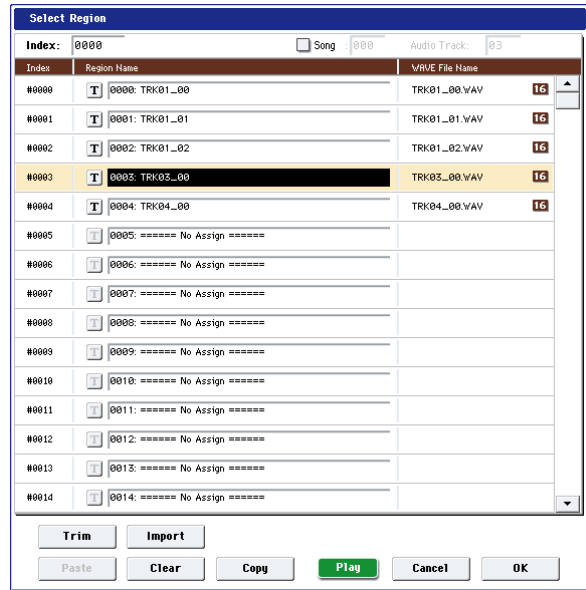

The procedure is the same as for “Region Edit.” The region will be changed when you press the OK button. If you press the Cancel button, the region will not be changed.

If stereo pairing is enabled and you’re editing a stereo audio event, the dialog box will appear twice. In the second dialog box, select the region for the other paired track.

**6. Use the buttons located at the bottom of the dialog box to edit the event.**

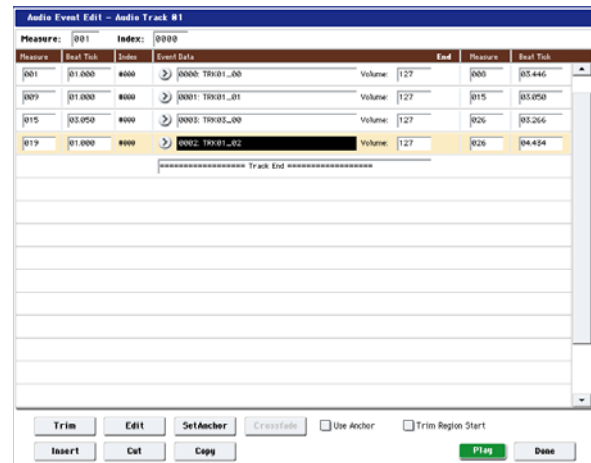

- **Inserting an event**  
Select the event that follows the location at which you want to insert, and press the Insert button. If you press the Insert button without having previously used the Copy button or Cut button to load audio event data into the copy buffer, only the first Select Region dialog box will appear; select the region that you want to insert as described in step 5, and then press the OK button. Press the Cancel button if you decide not to insert. (See
- **Deleting an event**  
Select the event that you wish to delete, and press the Cut button to delete the event.
- **Moving an event**  
You can use the Cut button and Insert button to move an event (by “cut and paste”).



Use the Cut button to delete the event that you wish to move, then use the Insert button to insert it at the desired location.

- Copying an event

Select the event that you wish to copy, and press the Copy button. Then select the copy destination and press the Insert button to insert the event at that location.

7. **“TRIM”:** This edits the area in which the region will sound.

Select the region that you want to edit, and press the Trim button to open the Trim dialog box.



The functions and operation are the same as in the trim dialog box of “Region Edit,” with the exception of “Trim Audio Event Start.” (See “Region Edit” on page 651.)

If you check “Trim Audio Event Start,” editing the “Start” value will simultaneously modify the location (Measure and “Beat Tick”) of the audio event. Check this option if you want to adjust the length without changing the position at which the entire event will sound. This will operate in the same way as if “Trim Region Start” is checked in step 4.

The region will be modified when you press the Done button. If you press the Cancel button, the region will not be modified.

8. **“Set Anchor”:** This sets the anchor point at the beginning of the first measure from where the audio event is placed.

Select the event that uses the region in which you want to specify an anchor point, and press the Set Anchor button. For more about how to use anchor points, refer to step 4.

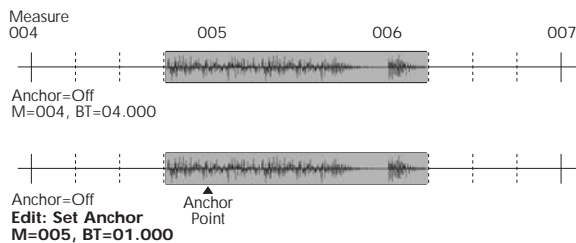

*Note:* If you want to edit the anchor point that is automatically set here, use TRIM to make adjustments in units of samples.

*Tip:* For example, you can specify the anchor point as the starting location of a region. Then you can turn on “Use Anchor,” and easily place that phrase at the beginning of another measure.

9. **Edit the waveform data of the WAVE file assigned to the region.**

Select an event that uses the region you want to edit, and press the Edit button to open the edit dialog box.



WAVE file waveform display, ZOOM

This area displays the waveform of the WAV file assigned to the region. The waveform display and ZOOM buttons operate in the same way as in Sampling mode, except that the displayed data is a WAVE file. Refer to the Sampling mode sections “1–1c: Sample waveform display” on page 697 and “1–1f: ZOOM” on page 698.

Edit Range Start [0000000...230399998]

Edit Range End [0000001...230399999]

“Edit Range Start” and “Edit Range End” set the range of the waveform that will be edited.

This range is highlighted in the “WAVE file display.” To audition the selected region, press the PLAY or SAMPLING START/STOP buttons.

Use Zero [Off, On]

**On (checked):** When you set “Edit Range Start” or “Edit Range End,” you will only be able to select zero-cross points; i.e., addresses at which the waveform level is at the center “zero” line. Use the VALUE slider, VALUE dial, or  $\Delta/\nabla$  switches to move to the previous or next zero-cross address. If you use the numeric keypad to enter a value directly, you will move to the zero-cross point that is nearest that value.

**Off (unchecked):** You can adjust the “Edit Range Start” and “Edit Range End” address in units of 1. This is the normal mode of operation.

Normalize

This command processes a WAVE file in the same way as the “Normalize/Level Adj.” menu command in Sampling mode. For more information, see “Normalize/Level Adjust” on page 737.

The “Normalize” command applies a uniform change to the sample levels between “Edit Range Start” and “Edit Range End.” It boosts the level of the sample data in the specified range as much as possible without causing it to clip. If the data was sampled at a low level, you can use this command to increase the dynamic range of the sample data. You can use Level to raise or lower the level as necessary.

10. **“Crossfade”:** This creates an event in which the volume is gradually modified in the area where two audio events overlap, causing them to be mixed.

Edit the location and end location so that the two events overlap. Then select the first of the two events, and press the Crossfade button to display the dialog box.



Use “Curve” to specify how the volume will change in the crossfaded portion.

**Linear:** The volume will change linearly.

**Power:** The volume will change in a non-linear power curve. Sometimes, using the Linear setting will produce the impression that the volume is less during the middle of the curve. If so, use the Power curve.

Press the OK button to execute the crossfade, or press the Cancel button if you decide to cancel.

**11. When you’re finished with audio event editing, press the Done button.**

By pressing the COMPARE switch you can return to the state prior to your audio event editing operations.

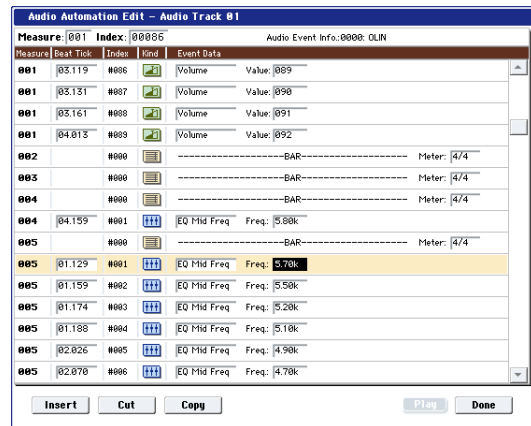

**3. Measure and Index located in the top line of the dialog box show the measure for editing and the index number of an event within that measure; this event is shown at the top of the list of events.**

You can use the scroll bar at right to move to the event you want to edit.

**4. Select the event you want to edit, and use the VALUE controller to input the desired values.**

- You can move the location of the event within the measure by editing the “Beat Tick” value.
- To edit the event data, input the desired values for each event.

**5. You can press the buttons located at the bottom of the dialog box to edit events as follows.**

- Inserting an event  
Select the location “Beat Tick” at which you wish to insert an event, and press the Insert button to insert an event.
- Deleting an event  
Select the event that you wish to delete, and press the Cut button to delete the event.
- Moving an event  
You can use the Cut button and Insert button to move an event (by “cut and paste”).  
Use the Cut button to delete the event that you wish to move, then use the Insert button to insert it at the desired location.  
You can also move an event by modifying its “Beat Tick” value.
- Copying an event

Select the event that you wish to copy, and press the Copy button. Then select the copy destination and press the Insert button to insert the event at that location.

**6. You can press the Play button to play back an audio event. During playback, an indication of “Stop” will appear, and you can stop playback by pressing this button.**

Playback will also stop when you reach the end of the audio event. This is available only if you’ve selected an audio event.

**7. When you’re finished with automation editing, press the Done button.**

If desired, you can press the COMPARE switch to return to the state prior to automation editing.

## Audio Automation Edit

This lets you edit individual automation data events. All edits are performed only on the single audio track that is selected, regardless of whether stereo pairing is on or off.

**1. Use Track Select to select the audio track that you want to edit, and use From Measure (4–1b) to specify the first measure that you want to edit.**

When you use **Track Select** to select Audio Track 01–16 and then choose “Automation Edit,” the Set Event Filters dialog box will appear.

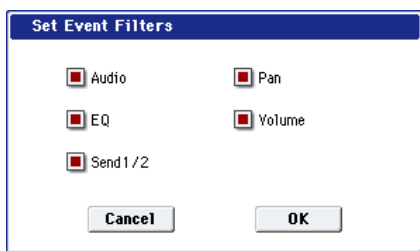

In the Set Event Filters dialog box, select the types of automation event data that you want to view or edit in the automation edit window.

Check each type of event (**Audio**, **Pan**, **EQ**, **Volume**, **Send 1/2**) that you want to see.

Audio events are shown in this window for reference, but they cannot be edited here. To edit them, use the “Audio Event Edit” command.

**2. Press the OK button to access the Automation Edit dialog box.**



The following table shows the types of “Automation Edit” events and the range of values.

Kind	Value	Value2
Region name (display only) (Audio events)		E:001.00.000... 999.15.191(Display only) (End of an audio event: measure, beat, clock)
Volume	0...127	
Pan	L000...R127	
Send1	0...127	
Send2	0...127	
EQ Bypass	On, Off	
EQ Input Trim	0...99	
EQ High Gain	-18.0...+18.0	
EQ Mid Cutoff	100...10.00k	
EQ Mid Gain	-18.0...+18.0	
EQ Low Gain	-18.0...+18.0	

### Set Song Length

This command changes the length of the specified song. When it is executed, the length of the master track will change, and the number of measures played will change.

1. Select “Set Song Length” to open the dialog box.

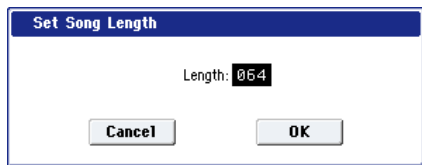

2. In “Length,” specify the length of the song.
3. To execute the Set Song Length command, press the OK button. To cancel without executing, press the Cancel button.

 All data following the measure specified by “Length” will be deleted. If you execute this command with “Length” shorter than the song, causing an audio event to extend beyond the end of the track, a new region will be automatically named and created to specify the region of the WAVE file that will actually be played.

The WAVE file itself will not be deleted.

### Erase Track

This command erases the data from the specified track. It is not possible to erase the master track by itself.

1. In Track Select, select the track that you wish to erase.
2. Select “Erase Track” to open the dialog box.

#### MIDI tracks



#### Audio tracks



3. Select the track whose data you want to erase.

If you do not check **All Tracks**, **All MIDI Tracks**, or **All Audio Tracks**, only the playback data of the track you selected in **Track Select** will be erased.

If you check **All Tracks**, the playback data of all tracks (MIDI tracks, master track, and audio tracks) will be erased. WAVE files and regions will not be erased.

If you check **All MIDI Tracks** (when **Track Select** is set to a MIDI Track 01–16), the playback data of all MIDI tracks (MIDI Track 01–16) will be erased.

If you check **All Audio Tracks** (when **Track Select** is set to an Audio Track 01–16), the playback data of all audio tracks (Audio Track 01–16) will be erased.

*Note:* WAVE files and regions will not be erased.

4. Press the OK button to execute “Erase Track.” If you decide not to execute, press the Cancel button.

### Copy Track

This command copies musical data from the copy source track to the specified track.

Be aware that the track data of the copy-destination will be erased when you execute the Copy Track operation.

1. Use **Track Select** to select the MIDI track (MIDI Track 01–16) or audio track (Audio Track 01–16) that you want to copy.
2. Select “Copy Track” to open the dialog box.

#### MIDI tracks

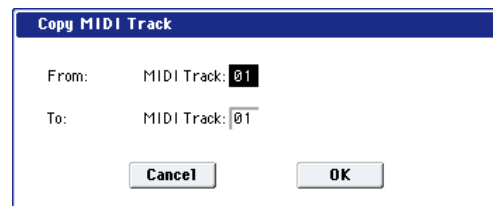

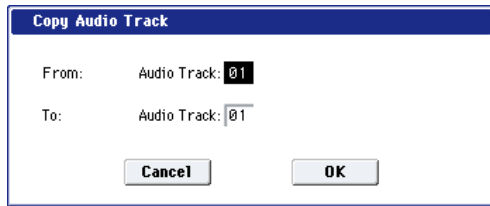
*Audio tracks*

3. Use "From" to select the copy-source track, and "To" to select the copy-destination.

(By default, the track you choose in **Track Select** will be specified for "From".)

When you copy an audio track, only the playback data (audio events and automation events) is copied; the WAVE files and regions are not copied.

 You can't copy between MIDI and audio tracks.

4. Press the OK button to execute the command. If you decide not to execute, press the Cancel button.

---

## Bounce Track

This command combines the musical data of the bounce source and bounce destination tracks, and places the combined data in the bounce destination. All musical data in the bounce source will be erased.

If MIDI control data existed in the bounce source track and bounce destination track, unexpected results may occur during playback after the bounce command is executed. To prevent this from happening, use the "MIDI Event Edit" or "Erase Control Data" menu commands to edit the MIDI control data of the two tracks before you use Bounce Track.

1. Use **Track Select** to select the MIDI track (Track 01–16) that you want to bounce.
2. Select "Bounce Track" to open the dialog box.

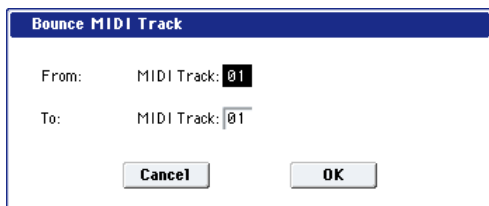

3. Use "From" to select the bounce-source track, and "To" to select the bounce-destination track.

(By default, the track you choose in **Track Select** will be specified for "From".)

4. Press the OK button to execute the command. If you decide not to execute, press the Cancel button.

In the case of "Bounce Track," the bounce-source track data will be set to "zero".

---

## Erase Measure

This command erases the specified type(s) of musical data from the specified range of measures. The Erase Measure command can also be used to remove only a specific type of data. Unlike the Delete Measure command, executing the Erase Measure command does not cause the subsequent measures of musical data to be moved forward.

1. Use **Track Select** to select the MIDI track (MIDI Track 01–16) master track or audio track (Audio Track 01–16), that contains the measures of data you want to erase.
2. Select "Erase Measure" to open the dialog box.

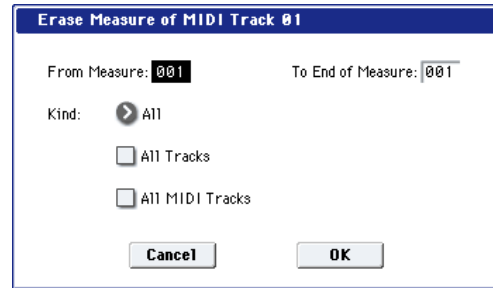
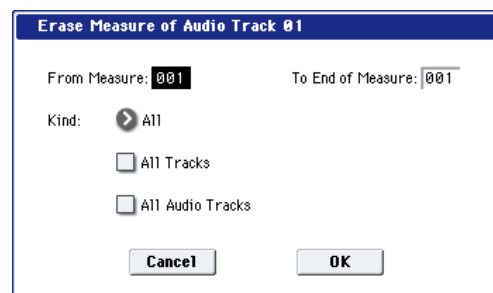
*MIDI tracks**Audio tracks*

3. In **From Measure** select the first measure to be erased, and in **To End of Measure** select the last measure to be erased.

(By default, **From Measure** and **To End of Measure** will be set to the range that you specified in the **Track Edit** page.)

4. Use "Kind" to select the type of data you want to erase.

**MIDI data:**

**All:** Erases all types of data in that track, including note data.

**Control Change:** Erases control change data.

**After Touch:** Erases both channel pressure and poly key pressure data.

**Pitch Bend:** Erases pitch bend data.

**Program Change:** Erases program change data.

**Exclusive:** Erases exclusive data.

**Audio data:**

**All:** Erase all data from that track.

**Audio Event:** Erase audio events.

**Automation Event:** Erase all automation events (EQ, Send 1/2, Pan, Volume).

**EQ:** Erase only EQ data (Bypass, Input Trim, High Gain, Mid Cutoff, Mid Gain, Low Gain).

**Send 1/2:** Erase only Send 1 and Send 2 data.

**Pan:** Erase only pan data.

**Volume:** Erase only volume data.

5. Select the track(s) for which you want to execute the command.

If you execute with **All Tracks**, **All MIDI Tracks**, and **All Audio Tracks** unchecked, the specified

“Kind” of data will be erased only from the track that’s selected in **Track Select**.

If you check **All Tracks**, the specified “Kind” of data will be erased from all tracks.

If you check **All MIDI Tracks** (when a MIDI Track is selected), the specified “Kind” of data will be erased from all MIDI tracks (MIDI Tracks 01–16).

If you check **All Audio Tracks** (when an Audio Track is selected), the specified “Kind” of data will be erased from all audio tracks (Audio Tracks 01–16).

6. To execute the Erase Measure command, press the **OK** button. To cancel, press the **Cancel** button.

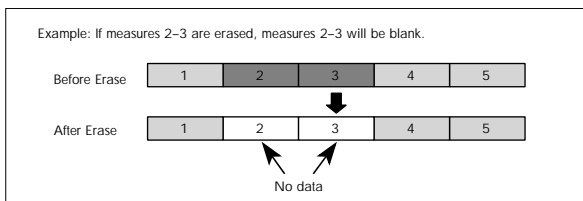

If data extends across the boundary between a measure being erased and a measure that is not being erased, only the portion that falls within the specified region will be erased.

Be aware that if note data extends across several measures, and you erase a measure that falls in the middle of the note, that note data will disappear from the subsequent measures as well.

*Note:* Note data can also be erased using the “Shift/Erase Note” menu command. Use this command when you wish to erase a specific range of notes, or to erase notes from a specific **Beat.Tick**.

*Note:* Control Change data can also be erased using the “Erase Control Data” menu command. Use this when you wish to erase a specific type of control change, or to erase control change data from a specific **Beat.Tick** range.

If you erase a portion of an audio event that extends across several measures, a new region that changes the region of the WAVE file that is played back will automatically be created and named.

*Note:* The WAVE file will not be deleted.

## Delete Measure

This command deletes the specified measures.

When the Delete Measure command is executed, the musical data following the deleted measures will be moved towards the beginning of the sequence.

1. Use **Track Select** to select the MIDI track (MIDI Track 01–16) or audio track (Audio Track 01–16) that contains the measures you want to delete.
2. Select “Delete Measure” to open the dialog box.

### MIDI tracks

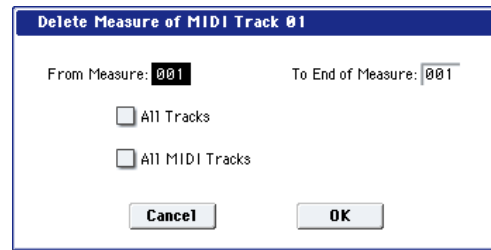

### Audio tracks

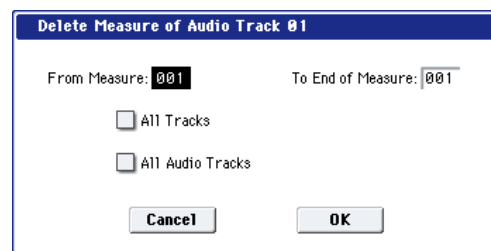

3. In **From Measure** select the first measure that you wish to delete, and in **To End of Measure** select the last measure that you wish to delete.

By default, the range of measures will be set as specified on the Track Edit page.

4. Specify the track(s) on which you want to execute the command.

If you execute with **All Tracks**, **All MIDI Tracks**, and **All Audio Tracks** unchecked, the specified measures of data will be deleted only from the track that’s selected in **Track Select**.

If you check **All Tracks**, the specified measures of data will be deleted from all tracks.

If you check **All MIDI Tracks** (when a MIDI track is selected), the specified measures of data will be deleted from all MIDI tracks.

If you check **All Audio Tracks** (when an Audio track is selected), the specified measures of data will be deleted from all audio tracks.

5. To execute the Delete Measure command, press the **OK** button. To cancel, press the **Cancel** button.

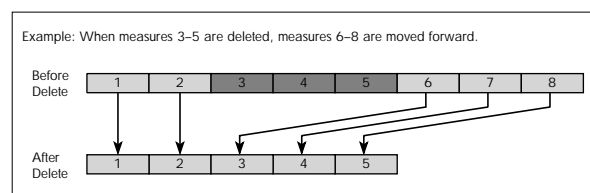

If in step 4 you uncheck **All Tracks** and execute this operation, the measures will not be deleted from the master track. Time signature and tempo data will remain unchanged, and the time signature and tempo of the measures that were moved forward as a result of the Delete operation will change.

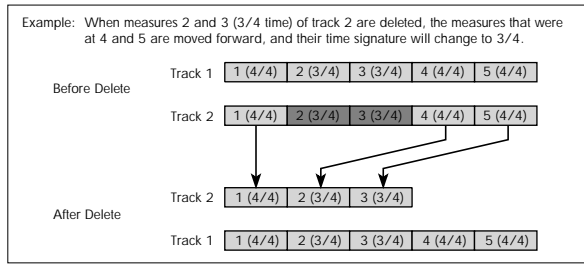

- If in step 4 you check **All Tracks** and execute this operation, the specified measures of musical data will be deleted from all tracks including the master track, and the time signature and tempo will also move forward by the number of measures that were deleted.
- If note data extends across several measures, and you delete a measure that falls in the middle of the note, that note data will disappear from the subsequent measures as well.
- If you erase a portion of an audio event that extends across several measures, a new region that changes the region of the WAVE file that is played back will automatically be created and named.

Note: The WAVE file will not be deleted.

## Insert Measure

This command inserts the specified number of measures into the specified track. Existing data following the insert location will be moved backward.

If you insert measures between note events that are connected by a tie, a note-off will be created immediately before the inserted measure, and the subsequent portion will be deleted.

1. Use **Track Select** to select the MIDI track (MIDI Track 01–16) or audio track (Audio Track 01–16) into which you want to insert measures.
2. Select **“Insert Measure”** to open the dialog box.

*MIDI tracks*

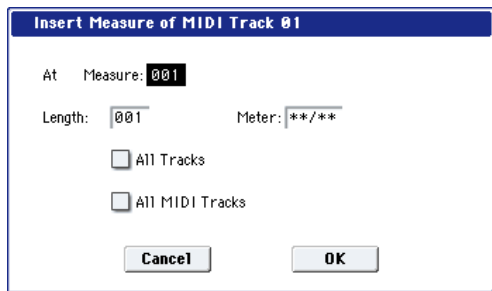

*Audio tracks*

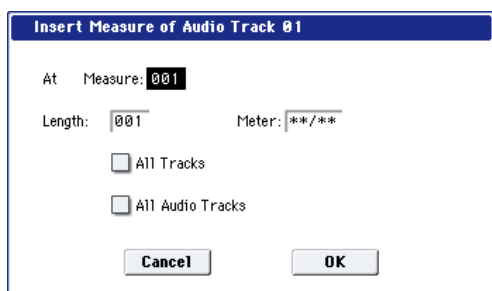

3. In **“At Measure,”** specify the measure location at which the data will be inserted. (The measure you specified in **Track Edit** page **From Measure** will be set as a default.)
4. In **“Length,”** specify the number of measures that will be inserted.
5. In **Meter,** specify the time signature of the measures that will be inserted.

If you want the inserted measures to match the existing time signature, specify **\*\*/\*\***. With any setting other than **\*\*/\*\***, the time signature of the inserted measures will change, and the specified time signature will apply to all tracks for those measures.

6. Specify the track(s) for which you want to execute the command.

If you execute with **All Tracks**, **All MIDI Tracks**, and **All Audio Tracks** unchecked, the measures will be inserted into the track that’s selected in **Track Select**. Be aware that at this time, the playback data that follows the insert location will move toward the end of the song according to the number of inserted measures, but the time signature and tempo will not move.

If you check **All Tracks**, the measures will be inserted into all tracks including the Master Track. The playback data in subsequent measures will play just as it did before this command was executed.

If you check **All MIDI Tracks** (when a MIDI track is selected), the measures will be inserted into all MIDI tracks.

If you check **All Audio Tracks** (when an Audio track is selected), the measures will be inserted into all audio tracks.

7. To execute the **Insert Measure** command, press the **OK** button. To cancel, press the **Cancel** button.

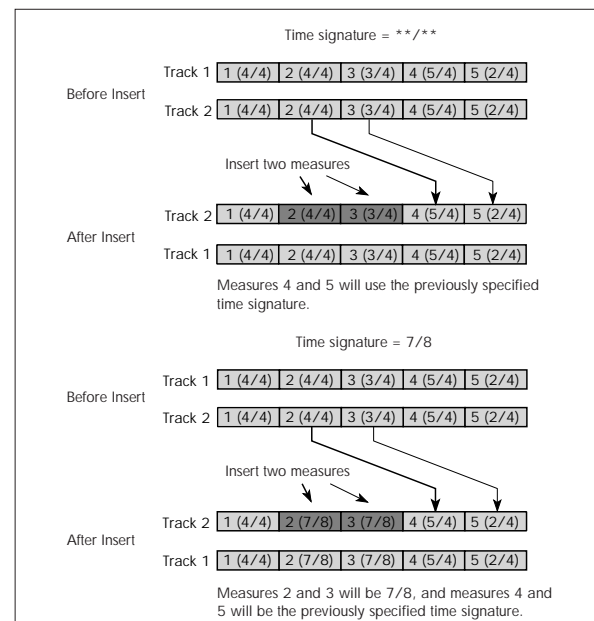

- If you execute **Insert Measure** at a location in the middle of an audio event that spans several measures, two new regions that play the regions divided at the **“At Measure”** will be automatically created and named.

Note: The WAVE file itself will not be modified.

## Repeat Measure

This command repeatedly inserts the specified measures for the specified number of times. When you execute the Repeat Measure command, the measures will be inserted following the measure specified by **To End of Measure**, and musical data following the inserted data will be moved backward. It is convenient to use this command when you have a song that you playback with “Track Play Loop” (0–3a) turned on, and wish to expand it into musical data.

1. Use **Track Select** to select the MIDI track (MIDI Track 01–16) or audio track (Audio Track 01–16) that you want to insert data into.
2. Select “Repeat Measure” to open the dialog box.

MIDI tracks

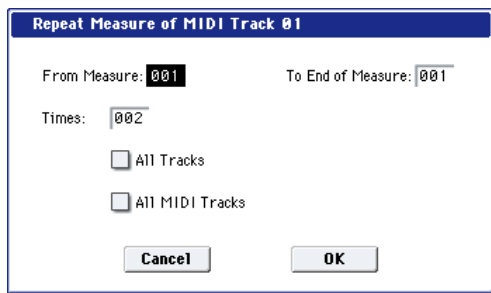

Audio tracks

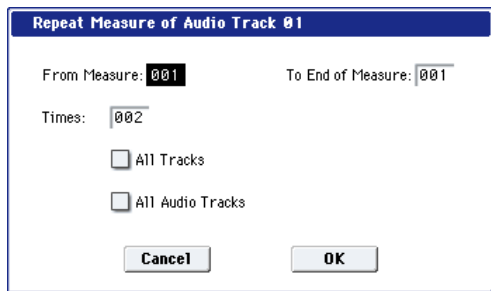

3. In **From Measure** and **To End of Measure**, specify the range of measures that will be repeated.

By default, the range of measures will be set as specified on the Track Edit page.

4. In **Times**, specify the number of repetitions.

For example if you set **From Measure** to 001, **To End of Measure** to 004, and **Times** to 2, the musical data of measures 1–4 will be inserted into measures 5–8. The result will be that measures 1–4 will be played twice.

5. Specify the track(s) for which you want to execute the command.

If you execute with **All Tracks**, **All MIDI Tracks**, and **All Audio Tracks** unchecked, the playback data will be inserted into the track that’s selected in **Track Select**. Be aware that at this time, the playback data that follows the inserted location will move toward the end of the song according to the number of inserted measures, but the time signature and tempo will not move.

If you check **All Tracks**, the playback data will be inserted into all tracks including the Master Track.

The playback data in subsequent measures will play just as it did before this command was executed.

If you check **All MIDI Tracks** (when a MIDI track is selected), the data will be inserted into all MIDI tracks.

If you check **All Audio Tracks** (when an Audio track is selected), the data will be inserted into all audio tracks.

6. To execute the Repeat Measure command, press the **OK** button. To cancel, press the **Cancel** button.

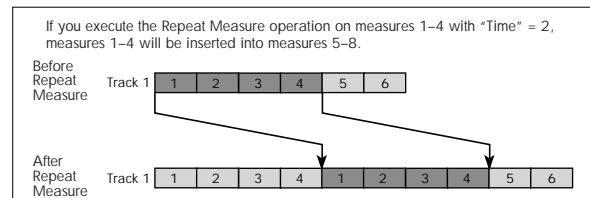

- ⚠ If you execute Repeat Measure at a location in the middle of an audio event that spans several measures, a new region will be automatically created and named.

Note: The WAVE file itself will not be modified.

## Copy Measure

This command copies the measures of musical data specified as the “From” source to the beginning of the measure specified as the “To” location.

When you execute the Copy Measure command, the existing track data at the copy destination will be rewritten.

1. Select the copy source song.
2. Select “Copy Measure” to open the dialog box.

MIDI tracks

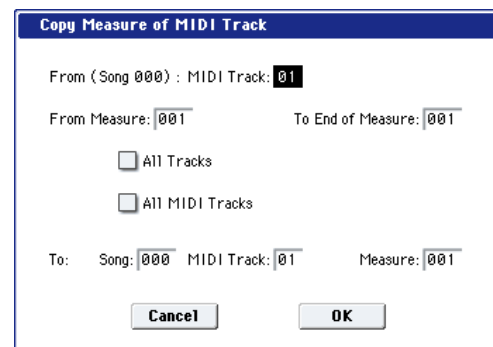

Audio tracks

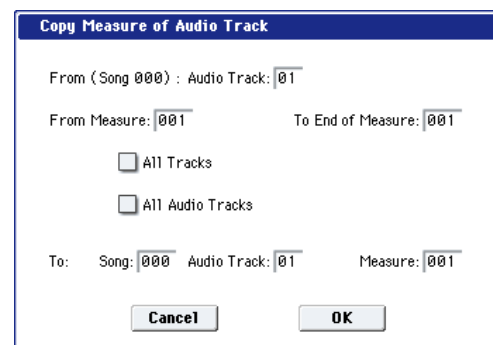

3. Use **From: Track** or “Audio Track” to select the copy-source track.



(By default, this will be the **Track Select** track.)

If you execute with **All Tracks**, **All MIDI Tracks**, and **All Audio Tracks** unchecked, only the selected track will be copied. Note that the time signature and tempo will not be copied.

If you check **All Tracks**, the playback data of all tracks including the Master Track will be copied.

If you check **All MIDI Tracks** (when a MIDI Track is selected), all MIDI tracks will be copied.

If you check **All Audio Tracks** (when an Audio Track is selected), all audio tracks will be copied.

**4. In From Measure and To End of Measure, specify the range of copy source measures.**

By default, the range of measures will be set as specified on the Track Edit page.

**5. Use To: Song to select the copy-destination song, use Track or "Audio Track" to select the copy-destination track (if you haven't checked All Tracks, All MIDI Tracks, or All Audio Tracks), and use Measure to select the measure at which the copied data will be inserted.**

 You can't copy between MIDI and audio.

**6. To execute the Copy Measure operation, press the OK button. To cancel, press the Cancel button.**

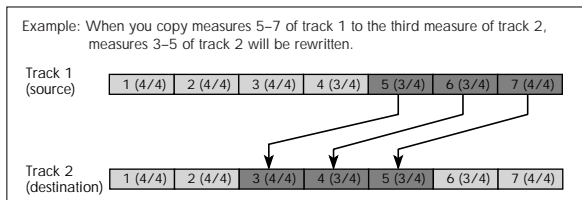

 If the copy-source you specify is a portion of an audio event that spans several measures, or if the copy-destination is a portion of an audio event that spans several measures, a new region will automatically be created and named when you execute the Copy Measure command.

*Note:* The WAVE file itself will not be modified.

## Move Measure

This command moves the specified measures to another location. Existing data at the destination will be pushed back to make room for the moved data, and the data surrounding the old location will be moved to fill in the gap.

**1. Select "Move Measure" to open the dialog box.**

*MIDI tracks*

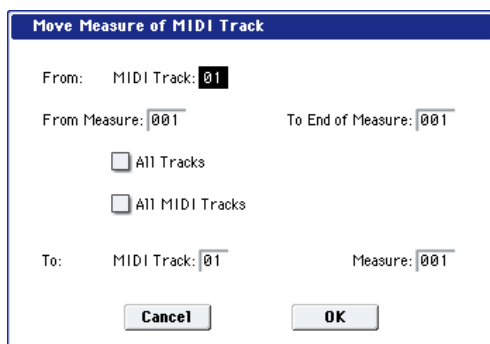

*Audio Tracks*

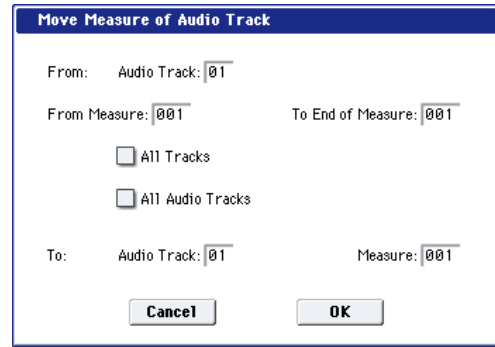

**2. Use From: Track or "Audio Track" to select the move-source track.**

(By default, this will be the **Track Select** track.)

If **All Tracks**, **All MIDI Tracks**, and **All Audio Tracks** are unchecked, only data from the selected track will be moved.

If you check **All Tracks**, the playback data of all tracks including the Master Track will be moved.

If you check **All MIDI Tracks** (when a MIDI Track is selected), all MIDI tracks will be moved.

If you check **All Audio Tracks** (when an Audio Track is selected), all Audio tracks will be moved.

**3. Use From Measure and To End of Measure to specify the region of measures that will be moved.**

By default, the range of measures will be set as specified on the Track Edit page.

**4. Use To: Track or "Audio Track" (if you haven't checked All Tracks, All MIDI Tracks, or All Audio Tracks) to select the destination track, and use Measure to select the starting measure at which the data will be inserted.**

 You can't move between MIDI and audio.

**5. To execute the Move Measure command, press the OK button. To cancel, press the Cancel button.**

 If you move a portion of an audio event that spans several measures, or if you move to a portion of an audio event that spans several measures, a new region will automatically be created and named when you execute the Move Measure command.

*Note:* The WAVE file itself will not be modified.

## Create Control Data

This command creates control change, aftertouch, pitch bend, or tempo data in the specified region of a MIDI track or the master track.

**1. In Track Select, select the MIDI track on which you wish to perform the Create Control Data command.**

If you wish to modify tempo data, select Master Track as the track. In this case, the step 4 item "Kind" will be set to "Tempo."

**2. Select "Create Control Data" to open the dialog box.**

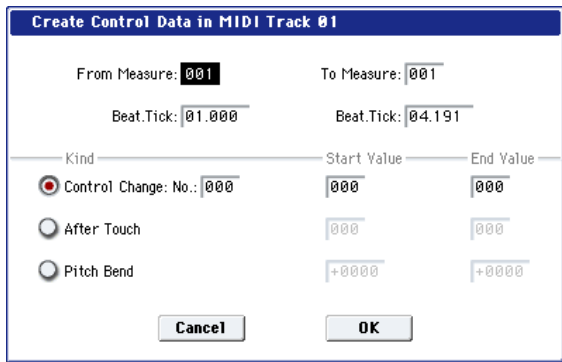

3. Specify the range into which the control data will be inserted.

In **From Measure** and **To End of Measure** specify the measures, and in **Beat.Tick** specify the beat and clock. (By default, the range of measures will be set as specified on the Track Edit page.)

4. Set "Kind" to the type of musical data (event) that you wish to create.

**Control change:** Control change data will be inserted. Use "#" to specify the CC number.

**After Touch:** Aftertouch data will be inserted.

**Pitch Bend:** Pitch bend data will be inserted.

**Tempo:** Tempo data will be inserted (if you've selected the master track).

5. In "Start Value," select the starting value of the control data. In "End Value," select the ending value of the control data.

By default, the "Start Value" will be set to the value of the existing data at the start location. If you wish to create control data that changes smoothly from the starting location, you can leave the "Start Value" unchanged, and set only the "End Value."

6. To execute the Create Control Data command, press the OK button. To cancel, press the Cancel button.

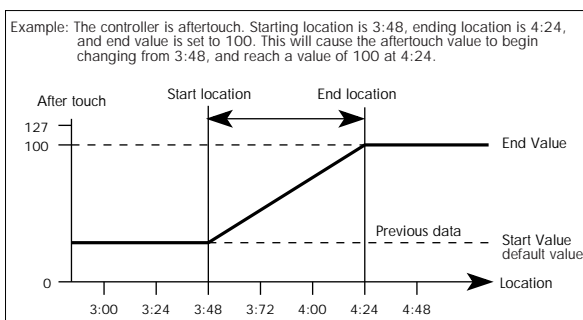

When you execute Create Control Data, a large amount of sequencer memory will be consumed. For this reason it may not be possible to execute this command if there is a limited amount of memory remaining. In such cases, first use the "Quantize" menu command to quantize the data and remove unnecessary control data. Alternatively, you could quantize the data inserted by the Create Control Data command.

## Erase Control Data

This command erases data such as control changes, after touch, pitch bend, or tempo in the specified range.

1. In **Track Select**, select the MIDI track from which you wish to erase control data.

If you wish to erase tempo data, select Master Track. In this case, the "Kind" item in step 4 will be Tempo.

2. Select "Erase Ctrl Data" to open the dialog box.
3. Specify the range from which you wish to erase control data.

In **From Measure** to **To End of Measure** specify the measures, and in **Beat.Tick** specify the beat and clock. (By default, **From Measure** and **To End of Measure** will be the range that was specified in the Track Edit page.)

4. Set "Kind" to the type of musical data (event) that you wish to erase.

**Control change:** Control change data will be erased. Use "#" to specify the control change number.

**After Touch:** Aftertouch data will be erased.

**Pitch Bend:** Pitch bend data will be erased.

**Tempo:** Tempo data will be erased. (If you've selected the master track)

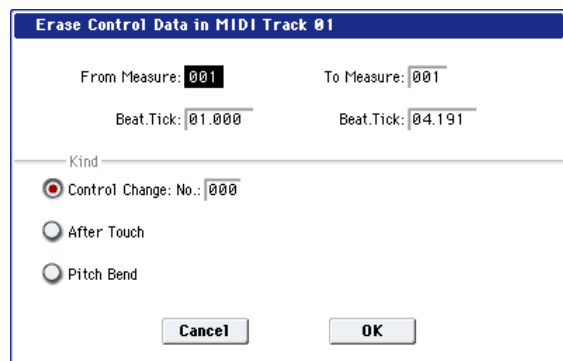

5. To execute the Erase Control Data command, press the OK button. To cancel, press the Cancel button.

*Note:* To erase all control change data from specified measures, you can also use the "Erase Measure" menu command, and set "Kind" to Control Change. However, the Erase Control Data command allows you to specify the range using **Beat.Tick**, and also to erase only specific types of control change data.

## Quantize

This command corrects the timing of MIDI data of the type you specify (note data, control change, aftertouch, pitch bend, program change, etc.) in the track.

When you execute the Quantize operation, the musical data will be affected as follows:

- When quantizing note data, only the timing of the note-on is affected; the length (duration of the note) is not affected.
- If the Quantize resolution is set to Hi, the timing will be adjusted to the base resolution (♩/192), so note data will not be affected. However, continuous controller data such as joystick or after touch will be processed so that duplicate events on the same



“tick” are combined into a single event, thus conserving memory.

Similarly, two or more data events of an identical type existing at the identical timing will be combined into one, also conserving memory.

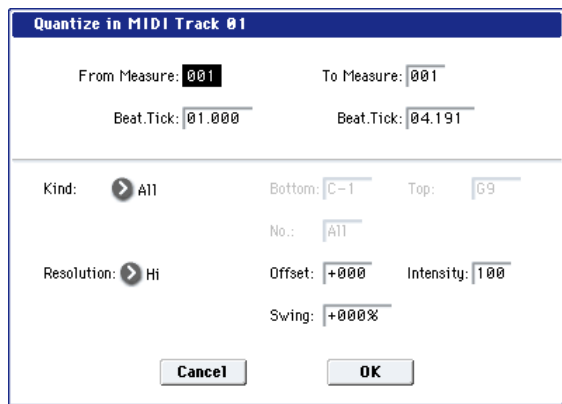

1. In **Track Select**, specify the track.
2. Select **“Quantize”** to open the dialog box.
3. Specify the range that will be quantized.

In **From Measure** and **To End of Measure**, specify the measures. In **Beat.Tick** specify the beat and clock. (By default, **From Measure** and **To End of Measure** will be the range that you specified in the Track Edit page.)

4. In **“Kind,”** select the type of musical data (events) that you wish to quantize.

**All:** Quantization will be applied to all performance MIDI data.

**Note:** Quantization will be applied only to note data. **Bottom** specifies the lowest Note that will be affected, and **Top** specifies the highest Note. You can use this when you want to quantize only a specific note or notes (for example, just the snare sounds of a drum track). If you want to quantize all notes, set these parameters C-1 and G9 respectively. These note settings can be entered by holding down the ENTER switch and playing a note on the keyboard.

**Control Change:** Quantization will be applied to control changes. To quantize only a specific control change, specify the number (“No.”). To quantize all control changes, select All.

**After Touch:** Quantize both Channel Pressure and Polyphonic Key Pressure messages.

**Pitch Bend:** Pitch bend data will be quantized.

**Program Change:** Program change data will be quantized.

5. In **“Resolution,”** specify the timing resolution to which the data will be corrected.

Lower resolutions can save memory, but if you set it too low, the timing may not be acceptable.

6. In **“Offset,”** specify the number of clock ticks by which the data will be moved forward or backward relative to the standard timing.

48 is a 16th-note; 96 is an 8th-note. Positive (+) settings move the timing forwards, and negative (–) settings move it backwards. This allows you to “push” or “drag” the beat.

7. In **“Intensity,”** specify the degree of sensitivity to which the timing will be corrected; i.e., how close to the locations specified by step 5 and 6 the data will be moved.

With a setting of 0, no correction will take place.

With a setting of 100, the data will be moved all the way to the timing intervals specified by step 5 and 6.

By varying the **Offset** and **Intensity** settings, you can create quantization effects such as the following:

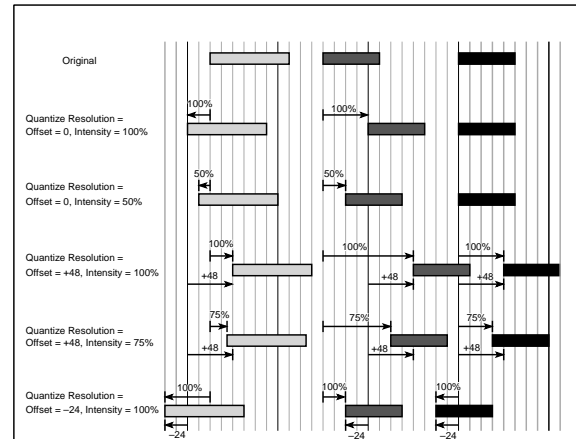

8. Use **“Swing”** to add a sense of swing to the rhythm. For example, this is an easy way to give a slight shuffle groove to a “square” 16-beat rhythm.

Settings other than 0% will adjust the positions of notes at even-numbered beats relative to the specified “Resolution.”

With a setting of +100%, notes will be moved one third of the way toward the specified “Resolution.” With a setting of +300%, notes of even-numbered beats will be moved all the way to the next even-numbered beat.

By varying the **Swing** settings, you can create effects such as the following:

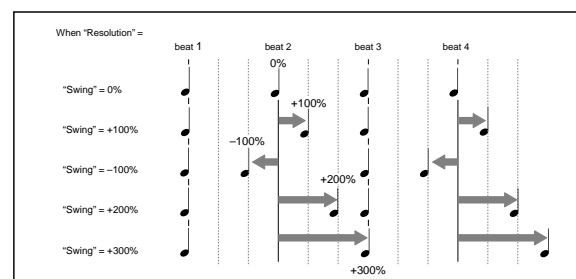

9. To execute the **Quantize** command, press the **OK** button. To cancel, press the **Cancel** button.

## Shift/Erase Note

This command shifts (moves) or erases the specified note numbers in a specified MIDI track and range of measures.

1. In **Track Select**, select the MIDI track on which you wish to execute the **Shift/Erase Note** command.
2. Select **“Shift/Erase Note”** to open the dialog box.

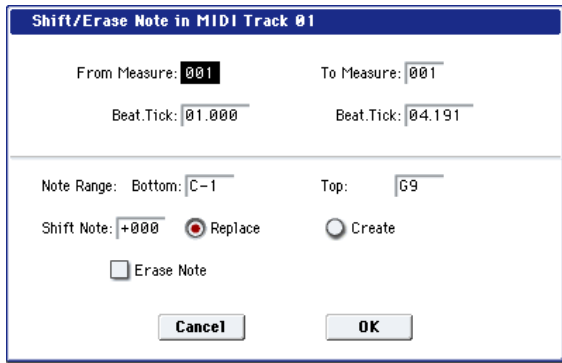

3. Specify the range in which you wish to shift or erase note numbers.  
In **From Measure** and **To End of Measure**, specify the measures. In **Beat.Tick**, specify the beat and clock. (By default, **From Measure** and **To End of Measure** will be the range that you specified in the Track Edit page.)
4. Specify the range of notes that you wish to shift or erase.  
**Note Range: Bottom** specifies the lower limit, and **Top** specifies the upper limit. If you wish to edit all notes, set **Bottom** to C-1 and **Top** to G9. These settings can also be made by holding down the ENTER switch as you play a note.
  - Shifting notes
5. In "Shift Note," specify the amount by which you wish to move the note.  
The amount of shift is set in semitone steps over a range of -127+127. +1 will shift the note a semitone upward.
6. Select either "Replace" to move the note numbers, or "Create" to generate additional notes.  
For example if you are editing a track that uses a drum program, you can use "Replace" to exchange the current snare sound for a different snare sound assigned to a different key, or use "Create" to add a sound effect at a different note # to the snare sound. Alternatively, you can use "Create" to add an octave doubling to an existing guitar phrase, etc.
7. To execute the Shift Note command, press the OK button. To cancel, press the Cancel button.
  - Erasing notes
8. Check "Erase Note."  
If you wish to erase all note data in the specified range of measures, you can also use the "Erase Measure" menu command and set "Kind" to Note. However, this Shift/Erase Note command lets you specify the **Beat.Tick** range, and to erase only specific ranges of note data.
9. To execute the Erase Note command, press the OK button. To cancel, press the Cancel button.

## Modify Velocity

This command modifies the velocity values of notes in the specified area so that they will change over time according to a selected curve.

1. In Track Select, specify the track whose velocity will be modified.
2. Select "Modify Velocity" to open the dialog box.

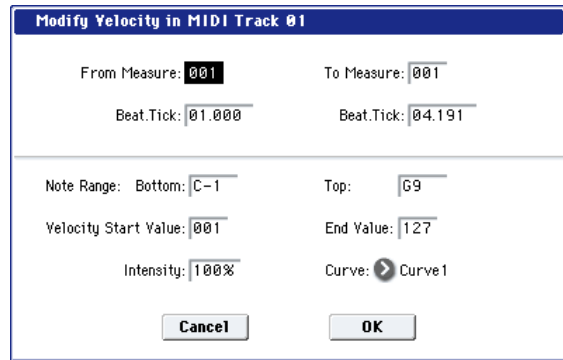

3. Specify the range in which note velocity will be modified.  
**From Measure** and **To End of Measure** specify the measure, and **Beat.Tick** specify the beat and clock. (By default, **From Measure** and **To End of Measure** will be set to the range that you specified in the Track Edit page.)
4. Specify the range of notes that will be affected by the Modify Velocity command.  
**Note Range: Bottom** is the lower limit, and **Top** is the upper limit. If you wish to edit all notes, set **Bottom** to C-1 and **Top** to G9. These settings can also be made by holding down the ENTER switch as you play a note on the keyboard.
5. In "Velocity Start Value" specify the value at which the velocity data will start, and in "End Value" specify the final velocity value.  
These settings can also be made by holding down the ENTER switch as you play a note on the keyboard.
6. In "Intensity," specify the degree to which the velocity data will be adjusted toward the curve you specify in step 7.  
With a setting of 0 [%], the velocity will not change. With a setting of 100 [%], the velocity will be exactly as described by the curve.
7. "Curve"\* lets you select from six types of curve to specify how the velocity will change over time.  
The six curves are as follows:

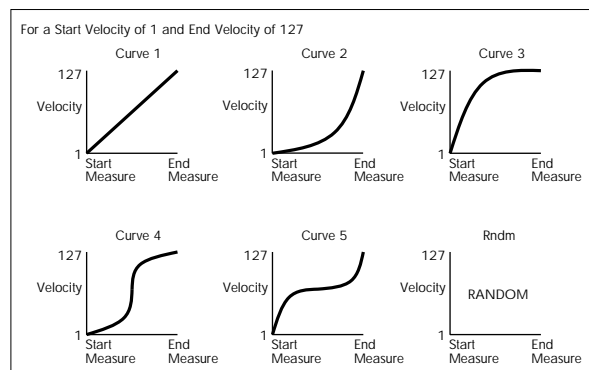

8. To execute the Modify Velocity operation, press the OK button. To cancel, press the Cancel button.

## Region Edit

Here's how to edit the regions used in an audio track.

In addition to Importing or Pasting a region, you can use the Trim dialog box to specify the range in which a WAVE file will play back.

- Editing a region will affect all audio tracks of the song. Use caution when editing a region that is already used by an audio track.

1. Use **Track Select** to select an Audio Track.
2. Choose **"Region Edit"** to open the region edit dialog box.

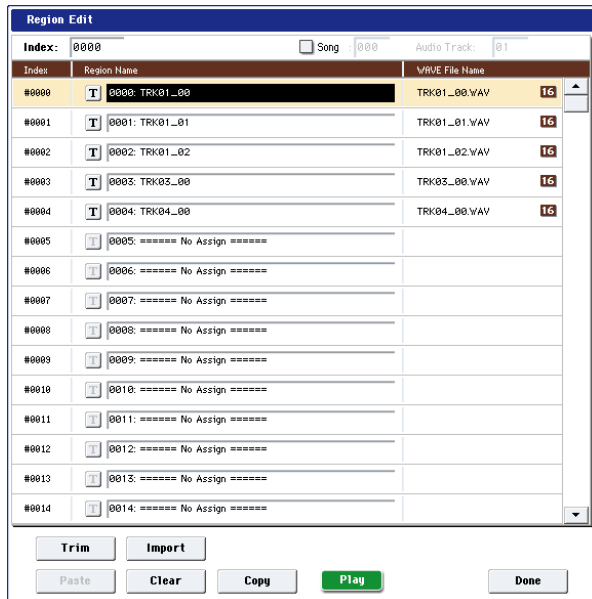

3. Use **Index** at the top of the dialog box to specify the index number of the region you want to edit; this will be displayed at the beginning of the list in the dialog box.

You can also touch the scroll bar at the right to move to the region you want to edit.

If you check **Song**, only regions of the specified song number and audio track number will be displayed. This is convenient if you have difficulty finding the region you want to edit.

The song number and audio track number of a region is specified when it is recorded. You can also modify these in the Trim dialog box (step 6).

4. If you want to edit the region name, press the text edit button.

Press the text edit button to open the text edit dialog box, and input the desired region name (up to 24 characters).

Regions whose names are shown as "No Assign" are empty. You cannot edit these names.

5. Select the region that you want to edit, and use the buttons at the bottom of the dialog box to edit the region.

The available buttons will differ depending on whether you've checked **Song**.

- Importing a region

You can copy a region from a .SNG file, or create a region from a WAVE file.

Select the region that you want to import, and press the Import button.

The Import dialog box will appear.

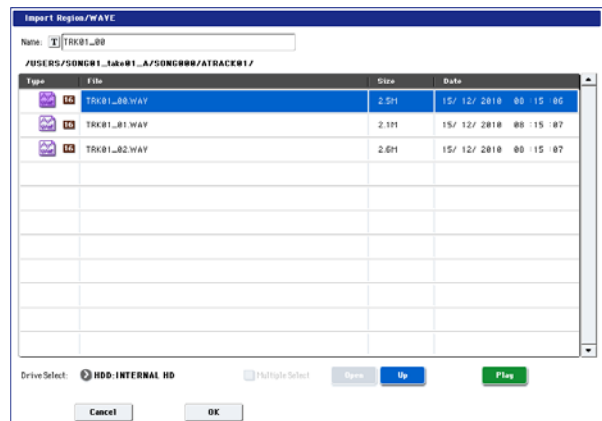

Use **"Drive Select," "Open,"** and **"Up"** to move to the desired directory, select the region file or WAVE file you want to import, and press OK.

You can use **"Name"** in the upper line to edit the name of the region. Edit **"Name"** after you've selected a file.

**Important:** You can only directly import WAVE files from the internal hard drive. To use files from CDs or external USB devices, you must first copy them to the internal hard drive, and then import the copied file into the Song.

- Note:** You can only import WAVE files with a sample rate of 44.1 or 48 kHz, and which are no longer than 80 minutes.

When you press the Play button, the selected WAVE file will play. (Play is available only for 44.1 and 48 kHz WAVE files). See also **"WAVE files"** on page 255 of the Operation Guide.

- Copying a region

Select the copy-source region and press the Copy button. Then select the copy-destination and press the Paste button or Insert button to paste (overwrite) or insert the region into that destination.

### Commands that are available if Song is unchecked

- Paste region

Select the region to which you want to paste, and press the Paste button to overwrite that region.

- Clear region

Select the region that you want to clear, and press the Clear button to clear that region.

### Commands that are available if Song is checked

- Insert region

Select the region at which you want to insert, and press the Insert button to insert a region.

- Cut region

Select the region that you want to cut (delete), and press the Cut button to delete that region.

6. **Play back the region.**

Select the region that you want to play back, and press the Play button to play the region from its **"Start"** to **"End"** (Trim step 6). During playback, the

Play button indication will change to Stop. You can press the Stop button to stop playback.

**7. Use the trim dialog box to specify the portion of the region that will play back.**

In the trim dialog box, select the region that you want to edit and press the Trim button to open the trim dialog box.



**WAVE file waveform display, ZOOM**

This area shows the waveform of the WAVE file that is assigned to the region.

The waveform display and the ZOOM buttons are the same as in Sample mode, except for the fact that the displayed data is a WAVE file. Refer to Sampling mode “1–1c: Sample waveform display” on page 697 and “1–1f: ZOOM” on page 698.

**Start [0000000...230399998]**

**End [0000001...230399999]**

“Start” and “End” specify the range (start address and end address) of the waveform that will be played. The range you specify here is highlighted in the “WAVE file display.”

**Duration**

This indicates the length between “Start” and “End.” (You can’t edit this indication.)

**Anchor Point [0000000...230399999]**

Here you can specify an anchor point, which is convenient when you need to move an audio event. (The value is shown in samples.)

Anchor points are used in audio event editing.

**Use Zero [Off, On]**

**On:** When you edit “Start,” “End,” or “Anchor Point,” you will be able to select only “zero-cross” addresses; locations at which the waveform level crosses the center line of the sample waveform display, and is therefore at ±0. When you operate the VALUE slider, VALUE dial, or △/▽ switches, the next or previous zero-cross point will be automatically found and selected. If you use the numeric keys 0–9 to enter a value, the nearest zero-cross address will be found automatically.

**Off:** You will be able to specify “Start,” “End,” and “Anchor Point” in units of a single sample. This is the normal setting.

**Duration Lock [Off, On]**

This specifies whether the length between “Start” and “End” will be fixed during editing.

**On:** If you edit the “Start” or “End” address, the “End” or “Start” address will automatically be

adjusted to preserve the existing length between “Start” and “End.”

**Allow Tempo [Off, On]**

This specifies whether the Region’s Tempo (see “Tempo [40.00...300.00],” below) will be used when executing the menu commands “Adjust Region to Song’s Tempo” or “Adjust Song’s Tempo to Region.”

Normally you will leave this turned on, and turn it off only when using “one-shot” samples such as rhythm instruments whose length you don’t want to change even if the tempo is changed.

This is turned on when you record or import.

**Tempo [40.00...300.00]**

This specifies the tempo of the region.

This tempo is used when executing the “Adjust Region to Song’s Tempo” or “Adjust Song’s Tempo to Region” page menu commands.

For more information, please see “Adjust Region to Song’s Tempo” on page 654, and “Adjust Song’s Tempo to Region” on page 653.

The tempo at the beginning of recording is set at the time of recording. With imported audio files, the tempo is set to 120.00.

**Song [000...199]**

**Audio Track [01...16]**

These specify the song number and audio track that are displayed when viewing regions for each audio track if you’ve checked **Song** for “Select Region” when using “Edit Region” or “Audio Event Edit.” For details, see step 2.

**Play/Stop**

When you press the Play button, the area from “Start” to “End” will play back, allowing you to audition the trimmed region. During playback, the button is displayed as Stop; playback will stop if you press it.

**8. If you want to keep the changes you made in the Trim dialog box, press the Done button.**

If you don’t want to save your changes, press the Cancel button. If you press the Cancel button, the region will revert to the state prior to entering the Trim dialog box.

**9. When you’re finished with Region Edit, press the Done button.**

## Volume Ramp

This command modifies the data values (volume) of the specified area. You can gradually increase (Fade In) or decrease (Fade Out) the volume between the start and end points.

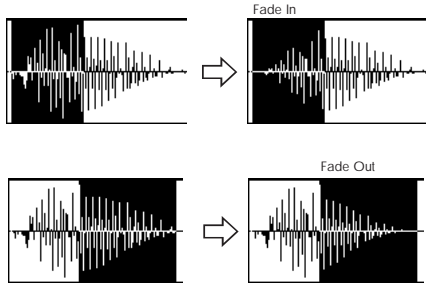

1. Use **Track Select** to select the audio track that you want to edit, and use **From Measure** and **To End of Measure** to specify the area that you want to edit.
2. Choose **“Volume Ramp”** to open the dialog box.

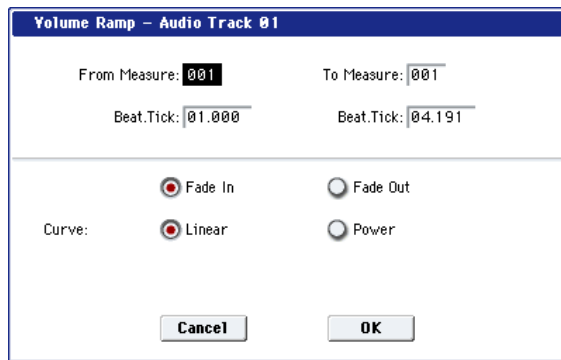

3. Use **From Measure**, **“To Measure,”** and **Beat.Tick** to specify the area on which you will execute the command.  
Specify the desired measures in **From Measure** and **“To Measure,”** and specify the beat and clock in **Beat.Tick**. By default, **From Measure** and **“To Measure”** are set to the range of measures you specified in **From Measure** and **To End of Measure** of the Track Edit page.
4. Use the radio buttons to select the type of volume ramp.  
**Fade In:** The volume will be zero at the beginning of the range, and will gradually increase toward the original volume at the end of the range.  
**Fade Out:** The volume will gradually decrease from the beginning of the range, reaching zero at the end of the range.
5. Use **“Curve”** to select how the volume will change.  
**Linear:** The volume will change linearly. Choose the Linear setting for a conventional fade-in or fade-out.  
**Power:** The volume will change non-linearly. In some cases, such as when you use the **“Mix”** menu command to mix (cross-fade) a faded-in waveform with a faded-out waveform, using the Linear setting may produce the impression that the volume is lower during the transition. If so, use the Power setting.
6. Press the **OK** button to execute the **Volume Ramp**, or press the **Cancel** button if you decide to cancel.

*Note:* When you execute this command, a new region and WAVE file will be created, and the file will be named automatically. The audio event will also be updated. Automation events will not be affected.

## Copy Song's Tempo to Region

This command changes the tempo used by the specified regions of audio events so that the audio event tempo will match the tempo of the location in which those regions play back.

If the tempo of an audio track matches the tempo of the MIDI tracks, executing this command to match the region tempo will ensure that the **“Adjust Region to Song's Tempo”** or **“Adjust Song's Tempo to Region”** commands can be executed correctly.

*Note:* The tempo of a region is specified at the time of recording. You can also modify it using **Trim** in **“Audio Event Edit.”**

- ⚠ The tempo will not be copied if **“Allow Tempo”** (Trim Dialog) is Off.
1. Use **Track Select** to select the track to which you want to copy the tempo.
  2. Choose **“Copy Song's Tempo to Region”** to open the dialog box.
  3. Use **From Measure** to select the first measure to which you want to copy the tempo, and use **To End of Measure** to select the last measure.  
(By default, **From Measure** and **To End of Measure** will be the range of measures you specified in the Track Edit page.)
  4. If you want to copy the sequencer tempo to all audio tracks, check **All Audio Tracks**.  
If this is not checked, the tempo data will be copied to the track you specified in **Track Select**.
  5. Press the **OK** button to execute the **Copy Song's Tempo to Region** command, or press the **Cancel** button to cancel without executing.

- ⚠ Executing this command will modify the region(s). Be aware that editing a region will affect the audio tracks of the entire song. Use caution when editing regions that are used by other audio tracks.

*Note:* This command will not affect audio events, automation events, or WAVE files.

## Adjust Song's Tempo to Region

This command creates tempo events in the master track to match the tempo of the regions used by the audio events in the specified range.

This is useful if you create audio tracks in a previously-recorded region, and want all tracks (including MIDI tracks) to match that region.

*Note:* The tempo of a region is specified at the time of recording. You can also modify it using **Trim** in **“Audio Event Edit.”**

- ⚠ Tempo events will not be created if **“Allow Tempo”** (Trim Dialog) is Off.
1. Use **Track Select** to select the track whose tempo you want to reference.



2. Choose “Adjust Song’s Tempo to Region” to open the dialog box.
3. Use **From Measure** to select the first measure in which you want to create tempo events, and use **To End of Measure** to select the last measure.  
(By default, **From Measure** and **To End of Measure** will be the range of measures you specified in the Track Edit page.)
4. If you want to create tempo events based on all audio tracks, check **All Audio Tracks**.  
If this is not checked, the track you specified in **Track Select** will be used as the basis for the tempo events that are created.
5. Press the **OK** button to create the tempo events, or press the **Cancel** button to cancel.

### Adjust Region to Song’s Tempo

If the tempo of regions used by audio events in the specified range differs from the tempo of the range in which those regions play back, you can execute Time Stretch (Sustaining) to create new WAVE files and regions. Audio events that use the newly created regions will also be created automatically.

If you want to change the tempo of a song you’ve already created, you can first execute “Copy Song’s Tempo to Region” so that the tempo of the master track etc. matches the song tempo and region tempo. Then you can create an audio track that matches the new tempo.

*Note:* The tempo of a region is specified at the time of recording. You can also modify it using Trim in “Audio Event Edit.”

 The Time Stretch command will not be executed if “Allow Tempo” (Trim Dialog) is Off.

1. Use **Track Select** to select the track for which you want to execute the Time Stretch command.
2. Choose “Adjust Region to Song’s Tempo” to open the dialog box.
3. Use **From Measure** to select the first measure to which you want to apply Time Stretch, and use **To End of Measure** to select the last measure.  
(By default, **From Measure** and **To End of Measure** will be the range of measures you specified in the Track Edit page.)
4. If you want to apply Time Stretch to all audio tracks, check **All Audio Tracks**.  
If this is not checked, the Time Stretch command will be applied to the track you specified in **Track Select**.
5. Use “Quality” to specify the audio quality of the sample that is produced by the Time Stretch command.

You can choose a setting in a range of 0–7. Although the result will depend on the type of sample, higher settings generally produce better results, but will take longer to execute.

Since you can try this command as many times as you like, start with a value of about 4, and raise it little by little if necessary.

6. Press the **OK** button to execute the Time Stretch command, or press the **Cancel** button to cancel.

*Note:* When you execute this command, new regions and WAVE files will be created, and file names and region names will be assigned automatically. The audio events will also be modified. Automation data will not be affected.

### Step Recording (Loop Type)

Here you can perform step recording into a pattern. This is available when a user pattern is selected.

1. In **Pattern** and **Pattern Select**, specify the pattern.

By default, the pattern length is one measure. If you wish to change the number of measures in the pattern, set the “Pattern Parameter.”

2. Select “Step Recording (Loop Type)” to open the dialog box.

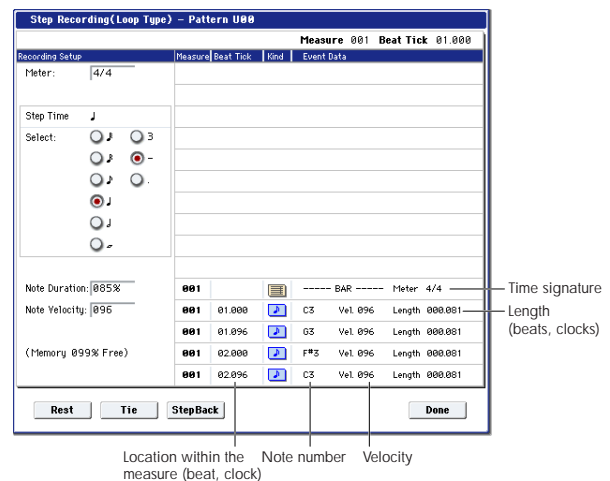

3. The remaining steps are the same as when step recording on a track.

Refer to steps 3 and following in the “MIDI Step Recording” menu command. However, step recording a pattern differs from step recording a track in that when you reach the end of the pattern, you will return to the beginning and continue recording, in this way continuing to add more data.

### Event Edit

Here you can edit individual events of the musical data in a pattern.

Use **Pattern** and **Pattern Select** to specify the pattern, and then select this command.

The remaining steps are the same as when editing a MIDI track using track event editing. See “MIDI Event Edit.”

## Pattern Parameter

This command specifies the number of measures and the time signature of the selected pattern.

1. Use **Pattern** and **Pattern Select** to specify the pattern.
2. Select **“Pattern Parameter”** to open the dialog box.

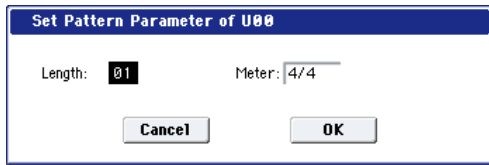

3. In **Length**, specify the number of measures in the pattern.
4. In **Meter**, specify the time signature of the pattern.  
However, this time signature is only temporary, and when you “put” or “copy” the pattern in a track of a song, the pattern will play according to the time signature of that measure.
5. To execute the **Pattern Parameter** settings, press the **OK** button. To cancel, press the **Cancel** button.

## Erase Pattern

This command erases the data from the selected pattern.

1. Use **Pattern** and **Pattern Select** to specify the pattern.
2. Select **“Erase Pattern”** to open the dialog box.

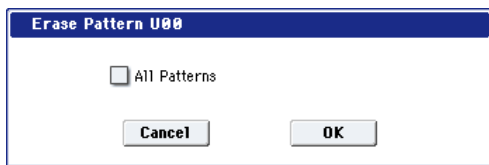

3. If you check **“All Patterns,”** all user patterns in the song will be erased.  
If **“All Patterns”** is not checked, only the pattern specified in step 1 will be erased.
4. To execute the **Erase Pattern** command, press the **OK** button. To cancel, press the **Cancel** button.

## Copy Pattern

This command copies the settings and musical data of the selected pattern to another pattern.

User patterns belong to a particular song, but you can use the **Copy Pattern** command to use the same pattern in another song.

Also, while preset patterns cannot be edited, you can copy a preset pattern to a user pattern and then edit and save it as a user pattern. Be aware that when you execute the **Copy Pattern** operation, the pattern settings and musical data of the copy destination will be erased.

1. Select **“Copy Pattern”** to open the dialog box.

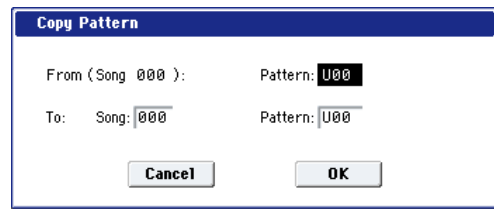

2. In **From (Song\*\*\*): Pattern**, specify the copy source pattern.  
(By default, this will be the song and pattern that was selected in the **Pattern Edit** page.)
3. In **To: Song and Pattern**, specify the copy destination song and pattern.  
For **Pattern**, only user patterns U00–U99 can be specified.
4. To execute the **Copy Pattern** command, press the **OK** button. To cancel, press the **Cancel** button.

## Bounce Pattern

This command combines the musical data of the bounce source pattern and bounce destination pattern, and places the combined musical data in the bounce destination. The time signature and length of the pattern following execution will be according to the settings of the bounce destination. Unlike the **Track Bounce** operation, the musical data of the bounce source will not be erased.

If MIDI control data exists in the selected pattern and in the bounce destination pattern, the resulting playback following the bounce operation may produce unexpected results. We recommend that you use the **“MIDI Event Edit”** command to prepare the MIDI control data of the two patterns before executing the **Bounce Pattern** command.

1. Use **Pattern** and **Pattern Select** to specify the bounce source pattern.
2. Select **“Bounce Pattern”** to open the dialog box.

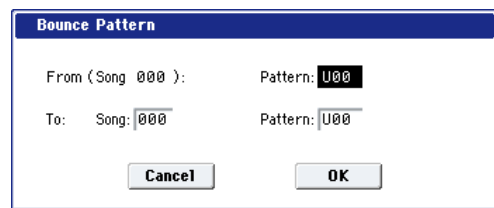

3. In **From (Song\*\*\*): Pattern**, select the bounce source pattern.  
(By default, the song and pattern that are selected in the **Pattern Edit** page will be chosen.)
4. In **To: Song and Pattern**, select the bounce destination song and pattern.  
For **Pattern**, only user patterns U00–U99 can be specified.
5. To execute the **Bounce Pattern** command, press the **OK** button. To cancel, press the **Cancel** button.



## Get From MIDI Track

This command takes musical data from a MIDI track and loads it into the specified pattern.

1. Use **Pattern** and **Pattern Select** to specify the pattern.
2. In the **“Pattern Parameter”** menu command, specify the pattern length of the **“get”** destination.
3. Select **“Get From MIDI Track”** to open the dialog box.

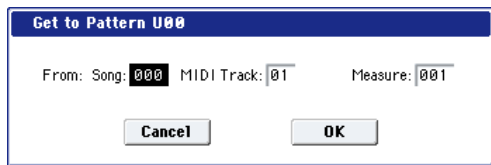

4. In **Song**, select the **“get”** source song.
5. In **Track**, select the **“get”** source MIDI track.
6. In **Measure**, specify the first measure of the **“get”** source.
7. To execute the **Get From MIDI Track** command, press the **OK** button. To cancel, press the **Cancel** button.

## Put To MIDI Track

This command places a pattern into a MIDI track.

Unlike the **“Copy To MIDI Track”** menu command, this command only places the pattern number in the song, so that when playback reaches that point, the pattern will be recalled. The musical data of the pattern will not actually exist in the track.

By creating patterns that contain frequently-used phrases or drum patterns, and then placing them on the tracks, you can conserve memory.

Be aware that when you edit a pattern, all locations in the song where that pattern has been placed will be affected.

When you execute the **Put To MIDI Track** command, the musical data will be affected as follows.

- Musical data previously existing at the **“put”** destination will be erased.
- The pattern that you **“put”** will playback according to the time signature that is specified by the measures of the **“put”** destination.
- Control data such as pitch bend etc. (but not including volume data) previously existing in the track will be reset immediately before the measure at which the pattern was **“put.”**

If you wish to use control data such as pitch bend in the measures in which a pattern is **“put,”** you must first write the control data into the pattern.

To delete a pattern that has been placed in a track you can use the **“Erase Measure”** menu command, specifying the area in which the pattern was **“put,”** and setting **“Kind”** to **All**.

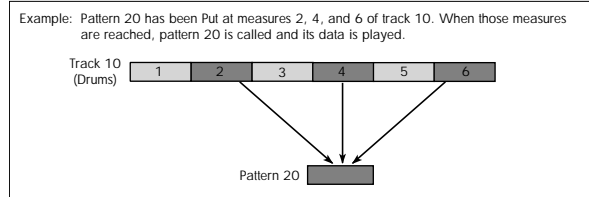

1. Select **“Put To MIDI Track”** to open the dialog box.

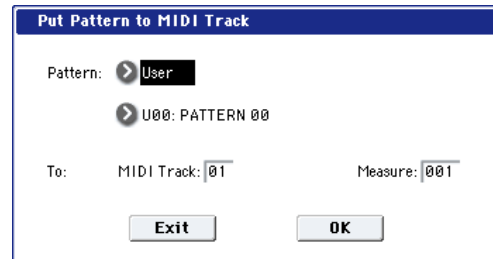

*Note:* If you press the **SEQUENCER START/STOP** switch while the dialog box is open, the selected pattern will play back.

2. In **Pattern** and **Pattern Select**, select the **“put”** source pattern.  
(By default, this will be the pattern selected in the **Pattern Edit** page)
- In **To: Track**, select the **“put”** destination MIDI track.
3. In **Measure**, specify the first measure of the **“put”** destination.
4. To execute the **Put To MIDI Track** command, press the **OK** button. When you execute the command, **Measure** will automatically count up.

If you wish to, you can continue **“putting”** the pattern. To exit the command, press the **Exit** button.

## Copy To MIDI Track

This command copies the specified area of musical data from the specified pattern to a MIDI track as musical data.

Unlike the **Put To MIDI Track** command, this command actually writes the musical data of the pattern into the MIDI track, so that you can edit the copied data in the track. Even if you later edit the copy source pattern, the musical data of the song will not be affected.

When you execute the **Copy To MIDI Track** command, the musical data will be affected as follows.

- Musical data previously existing in the copy destination measures will be erased.
- The musical data that is copied will playback according to the time signature specified at the copy destination measures.

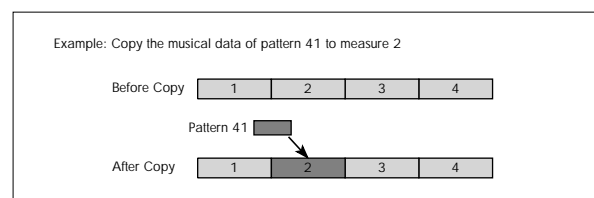

The procedure is the same as for the Put To MIDI Track command. For more information, see “Put To MIDI Track” on page 656.

## Convert to Drum Track Pattern

This command converts a user pattern into a user Drum Track pattern, which can then be used with the Drum Track in any mode. The converted Drum Track pattern will be preserved in the KRONOS's memory even when the power is turned off, so you can manage it together with the Programs and Combinations.

1. Use **Pattern and Pattern Select** to select the pattern you'd like to convert.
2. Select the **Convert to Drum Track Pattern** menu command to open the dialog box.

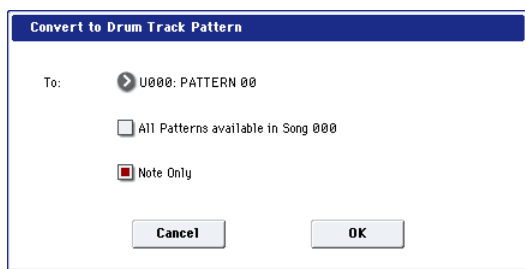

3. Use the **To Drum Track Pattern Select** field to specify the destination User Drum Track pattern.

Note that, when the command is executed, any data in this pattern will be overwritten.

4. If you check the **All Patterns available in Song \*\*\*** item, all patterns in the song that contain note events will be copied, starting at the number you specified in step 3.
5. If you execute with **Note Only** checked, only the note events will be copied.
6. Press the **OK** button to execute **Convert To Drum Track Pattern**, or press the **Cancel** button if you decide not to continue.

**⚠** If there isn't enough drum pattern memory, or if there aren't enough pattern locations, an error message of “Not enough Drum Track pattern memory” or “Not enough Drum Track pattern locations available” will appear, and the command cannot be executed.

*Tip:* It's a good idea to convert drum patterns that you use frequently. Use **Load Drum Track Pattern** to load them.

## Load Drum Track Pattern

This command loads a user drum track pattern into a user pattern.

If you want to edit a user drum track pattern, you must first load it into a Song pattern. Once it's in a pattern, you can edit it. After editing, you can use **Convert to Drum Track Pattern** to save it as a user drum track pattern.

1. Select **Load Drum Pattern** to open the dialog box.

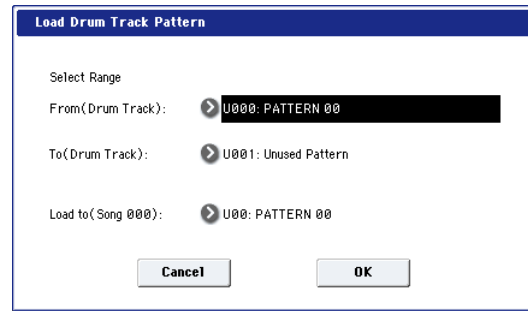

2. Use **Select Range From (Drum Track) and To (Drum Track)** to specify the copy-source user drum track pattern.

The user drum track patterns between **From** and **To** will be loaded. If you want to load only one pattern, set **From** and **To** to the same number.

When you execute this command, the data will be overwritten onto the copy-destination number.

3. Use **Load to (Song \*\*\*)** to specify the load-destination user pattern number.
4. Press the **OK** button to execute the **Load Drum Track Pattern** command, or press the **Cancel** button if you decide not to execute.

## Copy KARMA Module

Please see “Copy KARMA Module” on page 504.

## Initialize KARMA Module

Please see “Initialize KARMA Module” on page 505.

## Copy Scene

Please see “Copy Scene” on page 157.

## Swap Scene

Please see “Swap Scene” on page 157.

## Capture Random Seed

Please see “Capture Random Seed” on page 157.

## Auto Assign KARMA RTC Name

For more information, see “Auto Assign KARMA RTC Name” on page 148.

## Copy Note Map

Please see “Copy Note Map” on page 148

## Copy Insert Effect

Please see “Copy Insert Effect” on page 159.

**Note:** the slot's MIDI control channel, as specified by the **Ch** parameter on the IFX1–12 pages, will not be copied.

### Swap Insert Effect

Please see “Swap Insert Effect” on page 159.

**Note:** the slot’s MIDI control channel, as specified by the **Ch** parameter on the IFX1–12 pages, will not be swapped.

### Insert IFX Slot

Please see “Insert IFX Slot” on page 160.

### Cut IFX Slot

Please see “Cut IFX Slot” on page 161.

### Clean Up IFX Routings

Please see “Clean Up IFX Routings” on page 162.

### DrumKit IFX Patch

Please see “Drum Kit IFX Patch” on page 506.

### Copy MFX/TFX

Please see “Copy MFX/TFX” on page 162.

**Note:** the slot’s MIDI control channel, as specified by the **Ch** parameter on the MFX1–2 pages, will not be copied.

### Swap MFX/TFX

Please see “Swap MFX/TFX” on page 163.

**Note:** the slot’s MIDI control channel, as specified by the **Ch** parameter on the MFX1–2 pages, will not be swapped.

### Write FX Preset

Please see “Write FX Preset” on page 163.

### Put Effect Setting to Track

This inserts effect settings into a track as System Exclusive events. Use this when you want to change the effect settings during a song.

 If you use MIDI parameter change system exclusive messages to change the effect settings, it will take a certain amount of time for the effect change to occur. In addition, the sound may not change smoothly if sound is being produced at that time. Be aware of the timing of your playback data, and make the appropriate adjustments to the location at which the system exclusive message is inserted.

**Note:** If you switch effects during the song, you should also insert this command at the beginning of the track (**Measure** 001, **Beat.Tick** 01.000) as well, so that the song starts with the correct effect.

1. Use **P8: Insert Effect** or **P9: Master /Total Effect** to edit the effect you want to insert (IFX1–12, MFX1,

2, TFX 1, 2), and determine the song, track, measure, beat, and clock at which you should insert the System Exclusive event.

For example, let’s suppose that IFX6 which is used on track 3 needs to change at the beginning of measure 9.

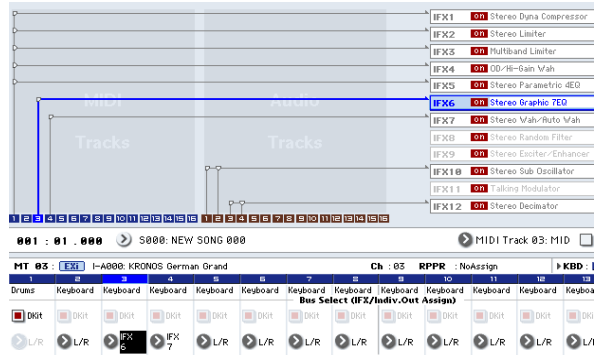

2. Select **Put Effect Setting to Track** to open the dialog box. (The values shown in the dialog box are the settings for example (1).)

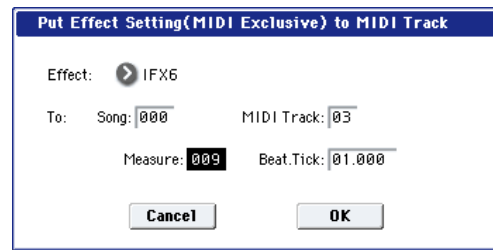

3. Use **Effect** to select the effect that you want to insert.
4. Use **To: Song** to specify the song, **Track** to specify the track, **Measure** to specify the measure, and **Beat.Tick** to specify the beat and clock at which you want to insert the event.
5. Press the **OK** button to execute the **Put Effect Setting to Track** command. If you decide to cancel, press the **Cancel** button.

 The inserted event contains only the type of effect and the effect parameters. You’ll need to realtime-record the effect on/off status and the bus, etc.

**Note:** Return the location to a point earlier in the song, and play back to verify that the effect changes as you intend. You can also use the **P4: Track Edit** page menu command “**MIDI Event Edit**” to verify that a parameter change system exclusive message (Exclusive) has been inserted.

**Note:** If a pattern has been inserted at the insert-destination, that pattern will be expanded into note data.

### Using “Put Effect Setting to Track” to switch effects

The “Put Effect Setting to Track” page menu command inserts effect settings into a track as exclusive event data.

In this example, we’ll apply IFX3 to MIDI track 2, and make the effect 051: Stereo Phaser change to 048: Stereo Flanger in the middle of the song. We’ll describe two ways of doing this; 1) and 2).

In order to perform this example, begin by making the following settings.

- In the P0: MIDI Track Prog Select/Mixer page, use “Program Select” to choose the desired program for MIDI track 02.
- In the P8: MIDI Routing 1 page, route MIDI track 02 “IFX/Indiv. Out Assign” to IFX3. Then in the P8–Insert Effect page, choose 051: Stereo Phaser for IFX3.

⚠ If you use MIDI parameter change system exclusive messages to modify effect settings, it will take a certain amount of time for the effect change to occur. If notes are sounding, there may be cases in which the sound does not change smoothly. Consider the timing of the performance data, and insert the system exclusive message at a location that will cause minimal disruption to the sound.

⚠ You can only insert events to specify the type of effect and the effect parameters. Settings for effect on/off and bus selection must be recorded in realtime.

1) Inserting effect settings at the beginning and in the middle of the song

In this example we’ll use the page menu command “Put Effect Setting to Track” to insert MIDI parameter change system exclusive messages into MIDI track 2 so that the insert effect (IFX3) uses 051: Stereo Phaser for measures 1 through 8, and 048: Stereo Flanger for measures 9 and following.

**1. Select the desired program for MIDI track 2, and send it to IFX3.**

Make the following settings for MIDI track 2.

**Track Select:** MIDI Track 02 (P0)

**Bus Select (IFX/Indiv. Out Assign):** IFX3 (P8)

Use the P0: MIDI Track Prog Select/Mixer page to assign the desired program to track 2, and use the P8: Insert Effect page to route the effect to track 3 and make effect settings.

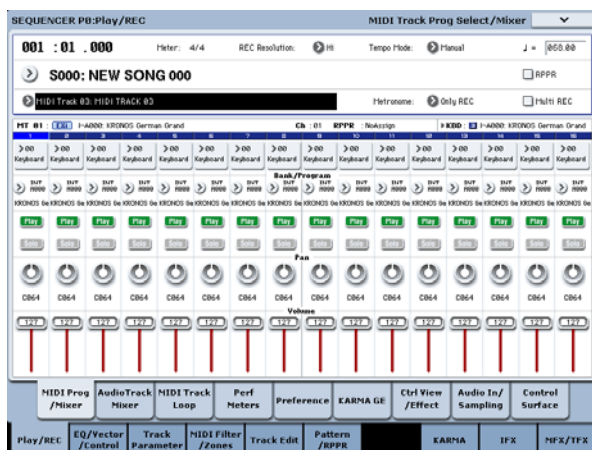

**2. Set Track Select to MIDI Track 02, and specify the desired routing.**

**3. In P8: Insert Effect, choose the “Put Effect Setting to Track” page menu command to open the dialog box.**

**4. Specify the effect and insertion location for the exclusive message you want to insert.**

**Effect:** IFX3

**To: Song:** 000

**Track:** 03

**Measure:** 001

**Beat.Tick:** 01.000

**5. Press the OK button.**

**6. Specify the effect that you want to use for measure 9 and following.**

Go to the P8: Insert FX page, and choose 048: Stereo Flanger for IFX3.

**7. In the P8: IFX 1-12–IFX3 page, set the parameters as desired.**

**8. In the P8: Insert FX page, choose the “Put Effect Setting to Track” page menu command to open the dialog box.**

**9. Specify the effect and insertion location for the exclusive message you want to insert.**

**Effect:** IFX3

**To: Song:** 000

**Track:** 03

**Measure:** 009

**Beat.Tick:** 01.000

**10. Press the OK button.**

When you play back after executing these commands, the effect on track 3 will change to 048: Stereo Flanger at measure 9.

**11. If you press the COMPARE switch (it will light) and play back, the playback will occur as it did before you executed “Put Effect Setting to Track.”**

You can use the COMPARE switch to compare the state of the track before and after execution.

**12. In the P4: Track Edit page, set Track Select to Track 03, and choose the “MIDI Event Edit” page menu command to access the event edit screen. (In the Set Event Filters dialog box, check “Exclusive.”)**

Notice that a MIDI parameter change system exclusive message is inserted at the beginning and at measure 9 of track 3.

2) Using the song’s own effect settings from the beginning of the song, and inserting effect settings from elsewhere into the middle of the song

In this example, we’ll apply an insert effect (IFX3) to MIDI track 3, and make settings so that it uses 051: Stereo Phaser from the beginning of the song. At measure 9, we’ll insert a MIDI parameter change system exclusive message to make IFX3 switch to the 048: Stereo Flanger effect settings that were created for a different song.

**1. Select a desired program for MIDI track 3, and send it to IFX3.**

Make the following settings for MIDI track 3.

**Track Select:** MIDI Track 03 (P0)

“Bus Select (IFX/Indiv.Out Assign)” : IFX3 (P8)

In the P0: MIDI Track Prog Select/Mixer page, assign a program to track 3. Then use the P8: Insert Effect page to route track 3 to the effect, and make effect settings.

2. Use **Track Select** to select MIDI Track 03, and record on it.
3. On a separate song you copied, make the effect settings that you want start using at measure 9.
  - 1) Create song S001.
  - 2) Use the “Copy From Song” page menu command to copy from Song 000 to Song 001.
4. In song 001, make the effect settings that you want to use from measure 9. Go to the **P8: Insert FX** page, and choose **048: Stereo Flanger** for **IFX3**.
5. In the **P8: Insert FX– IFX3** page, set the parameters as desired.
6. Choose “Put Effect Setting to Track” to open the dialog box.
7. Insert the effect settings you created in song 001 into song 000.

Effect: IFX3

To: Song: 000

Track: 03

Measure: 009

Beat.Tick: 01.000

8. Press the **OK** button to execute the command.

After execution, select song 000 and play it back. The effect for track 3 will change to **048: Stereo Flanger** at measure 9.
9. In song 000, you can press the **COMPARE** switch (it will light) and play back to hear the song as it was before you executed “Put Effect Setting to Track.”

You can use the **COMPARE** switch to compare the state of the track before and after execution.

*Note:* In the **P4: Track Edit** page of song 000, set **Track Select** to Track 03 and choose the “MIDI Event Edit” page menu command to access the Event Edit screen. (In the Set Event Filters dialog box, check “Exclusive.”)

Notice that a MIDI parameter change system exclusive message is inserted at measure 9 of track 3.

## System Exclusive events supported in Sequencer mode

You can record and play back System Exclusive events, and edit tracks that contain System Exclusive events.

### SysEx messages that can be recorded in real-time

The following exclusive messages can be recorded in real-time:

- Exclusive messages received from an external MIDI device
- Parameter changes in Sequencer mode (see table below)
- Master Volume universal exclusive messages assigned to the foot pedal or a knob

### Parameter change messages that you can realtime-record in Sequencer mode

Front panel/Page	Parameter	
Front panel	KARMA	ON/OFF, LATCH, MODULE CONTROL switches
	Control Surface	CONTROL ASSIGN, MIXER KNOBS, PAD MODE switches
P0: Play/REC	MIDI Prog Mixer	Program Select, Pan, Volume, PLAY/MUTE, Solo On/Off *1
	Audio Track Mixer	Rec Source, Pan, Volume, PLAY/MUTE, Solo On/Off *1
	Audio In Sampling	All "Audio Input" parameters
	Control Surface	All "RT/KARMA" – "REAL TIME CONTROL," "KARMA SCENE," "KARMA SWITCH," "KARMA SLIDER" parameters, "TONE ADJ." – Assign, Value
P1: EQ/Vector Control	MIDI Track EQ	Auto Load Prog EQ, Bypass, Input Trim, High Gain, Mid Frequency, Mid Gain, Low Gain
	Audio Track EQ	Bypass, Input Trim, High Gain, Mid Frequency, Mid Gain, Low Gain
	Drum Track	All "Drum Track" parameters
	Vector Volume	All "Vector Volume Control" parameters, VJS Assign, Center Volume, Enable Program Vector Volume
	Vector CC	All "Vector CC Control" parameters, Enable Song Vector CC, Enable Program Vector CC
	Vector Envelope	All "Basic," "Vector Envelope Loop," "Vector Envelope" parameters
	Set Up Controllers	All "Panel Switch Assign," "Modulation Knob Assign" parameters
	Pads	All "Pad Chord" parameters except "Enable Pad Play" and "Chord Assign On/Off"
P2: Track Param	MIDI	Track Priority
	OSC	Force OSC Mode, OSC Select, Portamento
	Pitch	Transpose, Detune, Bend Range, Use Program's Scale, Type, Key, Random
	Delay	Mode, Time, Base Note, Times
	WaveSeq KARMA	Key Sync, Swing, Quantize Trigger, KARMA Track On/Off Control
	Audio Track Delay	Mode, Time, Base Note, Times
P7: KARMA	GE Setup Key Zones	Load GE Options
	Name Note Map	All parameters except "Octave Replicate"
P8: IFX	MIDI/Audio Routing 1/2	"Bus Select, Send1, Send2, Fx Control Bus, Rec Bus
	Insert FX	IFX, IFX On/Off, Chain to, Chain, Pan, Bus Sel, REC Bus, Ctrl Bus, Send1, Send2
	IFX 1-12	All effect parameters
	Common FX LFO	All "Common FX LFO 1, 2" parameters
P9: MFX/TFX	Routing	MFX, MFX On/Off, Chain, Chain Direction, Chain Level, Return 1, Return 2, TFX, TFX On/Off, Master Volume
	MFX 1/2	All effect parameters
	TFX 1/2	All effect parameters

\*1: Solo On/Off is always controlled by events in the track, regardless of the play/mute status of that track.

 The maximum amount of exclusive data that can be recorded at once is approximately 320 Kbytes. This size will decrease if other events exist within the same measure.

 You cannot simultaneously record exclusive messages received from an external MIDI device and parameter changes produced by editing.

 If you record a parameter assigned to a control change such as **Pan** with the Global mode Global P1: MIDI, MIDI Filter settings "Enable Control Change" and "Enable Exclusive" both checked, edits you make during recording will be recorded both as control change data and parameter change

data. These recorded events may not be reproduced correctly if you rewind or fast-forward during playback. If you want to record such events, check only one of these two "Enable" settings in Global mode MIDI Filter.



# Set List mode

---

## Overview

Set Lists make it simple to play and organize any of the sounds loaded into the KRONOS, without regard for what bank they're stored in or whether they're Programs, Combinations, or even Songs.

Large on-screen buttons make sound selection fast and foolproof, and the Program Up or Down footswitch assignments can be used for hands-free sound changes. Cut, copy, paste, and insert tools make re-ordering a snap.

Smooth Sound Transitions let the previous sound and its effects ring out naturally, making it easy to change sounds during a live performance. Set Lists give you greater control over these transitions, in comparison to the other modes. You can fine-tune the ring-out time for each sound, so that (for instance) one sound fades out very quickly, while another sound's delays continue to repeat for ten or twenty seconds.

Long comments let you store lyrics or performance notes with the sound.

Set Lists are great for live performance, but they're also handy for organizing sounds in general. For example, you could create a Set List with all of your favorite String sounds, including both Programs and Combinations.

## Set List P0: Play

### 0-1: Play

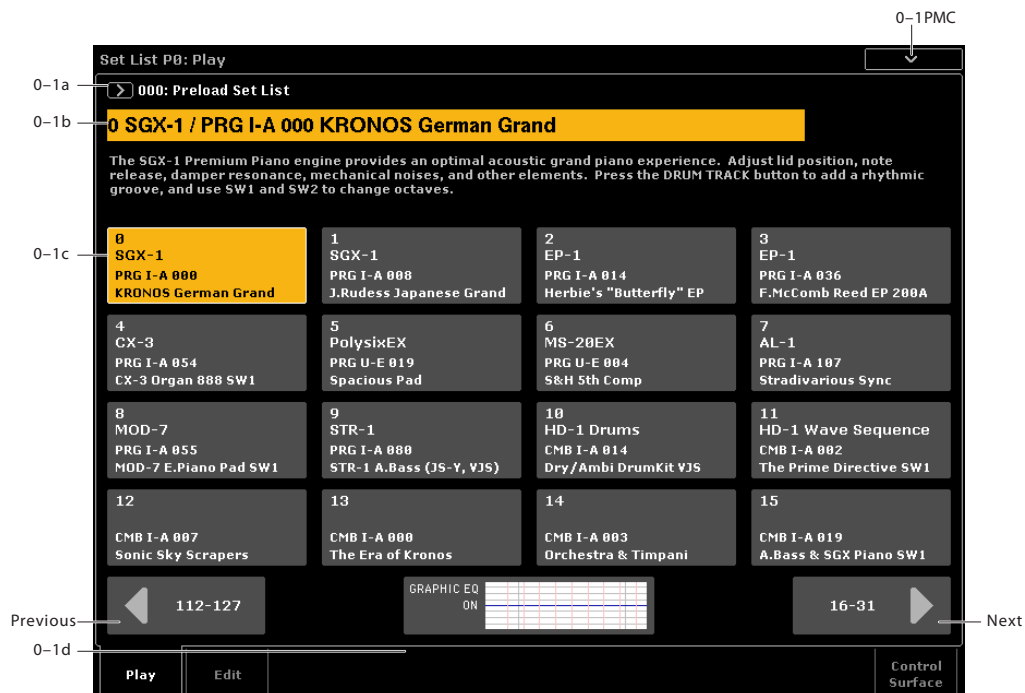

### Overview

A Set List has 128 Slots, each of which can be assigned to any Program, Combination, or Song. You can have 128 Set Lists in memory at once.

The large name in the Set List display is the name of the current Slot, so that you can easily see the sound that you're playing. The Set List name is in smaller text at the top left-hand corner of the screen.

For more information on using Set Lists, see "Set Lists" on page 113 of the Operation Guide.

On this page, you can:

- Select the current Set List
- Select Slots within the Set List (Programs, Combis, Songs).
- View the comments for the selected Slot
- View the current EQ curve, and jump quickly to the EQ controls.

### 0-1a: Set List Select

#### Set List Select [000...127]

This is the Set List, which contains the Slots.

### 0-1b: Slot information

This section shows information for the selected Slot. The number, Slot name, and Program, Combination, or Song name are shown in large text. The comment is shown in smaller text below. Use the scroll bar on the right to view longer comments.

### 0-1c: Slot Select

#### Slot Select [000...127]

The 128 Slots are shown 16 at a time. To select a slot, simply touch it. (You can use other methods, as described below.) To move to another group of 16, use the Previous and Next buttons at the bottom of the display.

#### Selecting Slots

##### Selecting within the current group of 16

To select one of the 16 Slots shown on the display:

##### 1. Press the desired button.

The button becomes highlighted, and the comments and large slot number/name at the top of the screen are updated accordingly.

##### Selecting outside the current group of 16

To select a new slot which is not within the current group of 16:

##### 1. Use the next and previous arrow-buttons at the bottom of the screen to browse through the groups of 16.

The labels for next/previous will vary depending on the current group of 16; for instance, if the current group is 0-15, the buttons will show 112-127 and 16-31, respectively.

As you browse, the current selection does not change until you actually press one of the 16 buttons.

##### 2. When the desired group of 16 is displayed, press the button for the desired slot.

The button becomes highlighted, and the comments and large slot number/name at the top of the screen are updated accordingly.

### Selecting using data entry controls

In addition to using the touch-screen buttons, you can select Set List and Slots using the standard data entry controls, including the numeric keypad, rotary encoder, and Inc/Dec.

The VALUE slider is reserved for modulation, sending CC#18 when the slot contains a Program or Combination.

### Next/Previous buttons wrap

The next and previous buttons wrap within the current Set List. For instance, if you're currently looking at Slots 0-15 of Set List 003, and you press the 112-127 button, the screen changes to show Slots 112-127, still in Set List 003.

### Inc/Dec and Program Up/Down, when selection is off-screen

The Inc/Dec and the Program Up/Down footswitches operate on the current selection, regardless of which group of 16 is currently shown. For instance:

1. Select Slot 3.
2. Use the "next" button to show Slots 16-31.
3. Press the Inc button, or a footswitch assigned to Program Up.

Slot 4 is selected, and the display returns to Slots 0-15.

### Returning to the current group of 16 Slots

If you have navigated away from the current group of 16, you can return easily:

1. Touch the name of the current Slot, at the top of the screen (see "0-1b: Slot information" on page 664).

The display changes to show the group of 16 containing the current selection.

### Next/Previous Slot selection

In addition to selecting Slots via the on-screen buttons, you can use Inc/Dec or a footswitch assigned to Program Up or Program Down to step through sounds.

### Selecting with Inc/Dec

1. Touch one of the 16 on-screen Slot buttons.

Once a Slot is selected, you can use the Inc and Dec buttons to step through the list of sounds.

If you're on the 16th button on the current page, pressing Inc will advance you to the first button of the next group of 16.

### Program Up/Down footswitch

The Program Up and Program Down footswitches always step through the list, regardless of whether or not one of the buttons has the UI focus.

The footswitch can be assigned to Program Up or Program Down on the Global mode Controllers page.

### Wrapping between Set Lists

Inc/Dec and Program Up/Down wrap between Set Lists. For instance:

1. Select Slot 127 in Set List 5.
2. Press Inc, or the Program Up footswitch.

Slot 0 of Set List 6 is selected.

Similarly:

1. Select Slot 0 in Set List 5.
2. Press Dec, or the Program Down footswitch.

Slot 127 of Set List 4 is selected.

Note that when changing to a different Set List, any edits to the Set List will be lost.

### Wrapping between Set List 0 and Set List 127

Inc/Dec and Program Up/Down wrap between Set Lists 0 and 127. For instance:

1. Select Slot 127 in Set List 127.
2. Press Inc, or the Program Up footswitch.

Slot 0 of Set List 0 is selected.

Similarly:

1. Select Slot 0 in Set List 0.
2. Press Dec, or the Program Down footswitch.

Slot 127 of Set List 127 is selected.

Programs wrap in a similar fashion, between INT-A 000 and USER-GG 127.

### Selection via MIDI

#### MIDI In

Program Change messages on the Global Channel select the Slot, and Bank Select messages on the Global Channel select the Set List.

When a Slot is selected via MIDI, the display updates if necessary to show the appropriate group of 16 buttons.

#### MIDI Out

Selecting a Slot sends Program Change and Bank Select messages, as above.

When selected, Combinations and Songs can transmit other Program Change and Bank Select messages on other channels, as they do in Combination and Sequencer modes.

### Global P0 Bank Map

The Global P0 Bank Map (Korg, GM(2)) parameter does not affect the reception or transmission of Set List Program and Bank Select messages.

### Editing the selected Program, Combination, or Sequence

When you're in a rehearsal or sound-check, you may need to make quick edits to a sound in the Set List.

With this in mind, you can:

- Jump to the editing pages for the selected Program, Combination, or Song
- Make the desired edits
- Save the edits
- Return easily to the original Set List page

For more information, see “Edit Program/Combination/Song” on page 673.

### **Continuous playback with Songs**

Two or more slots can be set to the same Song, but with different Keyboard Tracks. You can switch between such Slots, changing the sound assigned to the keyboard, as the song continues to play.

---

### **0–1d: EQ Graphic**

The graphic at the bottom of the page shows the frequency curve created by the Set List EQ, along with whether or not the EQ is bypassed. Touch the graphic to jump directly to the Control Surface EQ page. For more information, see “9–1b: Graphic EQ” on page 671.

---

### **▼ 0–1: Page Menu Commands**

The number before each command shows its ENTER + number-key shortcut. For more information on these shortcuts, see “ENTER + 0-9: shortcuts for menu commands” on page 147.

- **0: Write Set List.** For more information, see “Write Set List” on page 673.
- **1: Exclusive Solo.** For more information, see “Exclusive Solo” on page 147.
- **2: Initialize Set List.** The name changes depending on the type of the selected item. For more information, see “Initialize Set List” on page 673.
- **3: Edit Program/Combination/Song.** The name changes depending on the type of the selected item. For more information, see “Edit Program/Combination/Song” on page 673.
- **4: Update Program/Combination.** The name changes depending on the type of the selected item. For Songs, it is grayed out (or does not appear). For more information, see “Update Program/Combination” on page 673.

# Set List P1: Edit

## 1-1: Edit

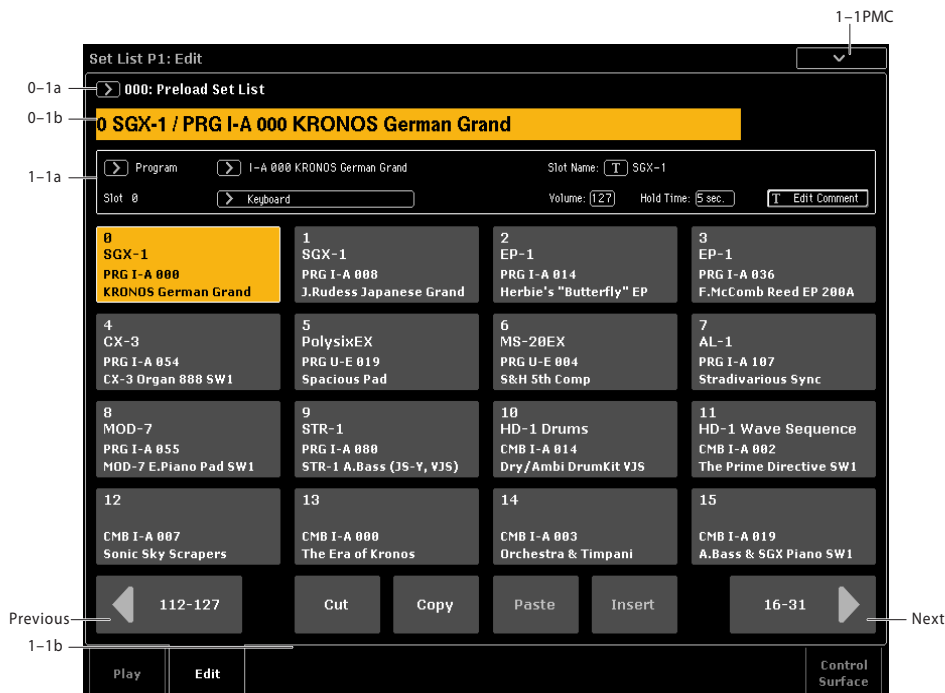

On this page, you can:

- Edit the individual Slots in the list, including their Program/Combination/Song assignment, comment text (such as lyrics or performance notes), name, volume, hold time, and keyboard track (for Songs).
- Change the order of items in the list, using the Cut, Copy, Paste, and Insert buttons.

The 16 items shown here are the same 16 as shown on the Select page. Changing the group of 16 shown in one place changes in the other.

### 0-1a: Set List Select

**Set List Select** [000...127]

This is the Set List, which contains the Slots.

### 0-1b: Slot number and name

This section shows information for the selected Slot, including the number, Slot name, and Program, Combination, or Song name. To select the Slot, use the 16 buttons below.

### 1-1c: Slot parameters

**(Item Type)** [Program, Combination, Song]

Each slot can hold either a Program, a Combination, or a Song.

**Program/Combination/Song Select** [List]

This shows the bank, number, and name of the Slot's Program or Combination, or the number and name of the Slot's Song (Songs don't have banks).

Pressing the button brings up a popup menu which you can use to select Programs, Combinations, or Songs, depending on the **Type** setting.

Note that you can use the same sound in multiple Slots within the same Set List. This can be convenient, for instance, for live performance when using a foot switch to automatically advance from Slot to Slot.

For more information on selecting by bank and number, see "Program Select" on page 3, "Combination Select" on page 416, and "Song Select" on page 515.

**Category** [List]

This button shows the Category of the Slot's Program or Combination. If the current Slot is a Song, this does not appear.

Pressing the button brings up a popup menu which you can use to select Programs or Combinations, as an alternative to selecting by bank and number.

For more information on using Categories, see "Category" on page 4 and "Combination Select" on page 416.

**Keyboard Track** [1...16]

For songs, you can assign the local keyboard to play any of the 16 MIDI tracks. If you like, you can have the same Song in multiple Slots, each with a different Keyboard Track. You can then switch between the Slots, changing the sound assigned to the keyboard, as the Song continues to play.

This parameter applies to Songs only. If the current Slot is a Program or Combination, it does not appear.

**Slot Name** [24 characters]

You can name the Slot separately from the name of the Program, Combination, or Song it contains. For instance, if you're creating a Set List for a gig, you can name the Slots after the section of music in which they're used, such as "Montana Intro."

Pressing the text edit button brings up the text edit dialog box. Slot names can have up to 24 characters.

**Volume** [0...127]

This sets the volume for the current slot.

Note that the stored Master Volume setting of the Slot's Program, Combination, or Song still applies as well. You can edit this from the Control Surface, if desired.

See the graphic below for details on how the Set List volume interacts with other volume controls.

Set List Slot Volume

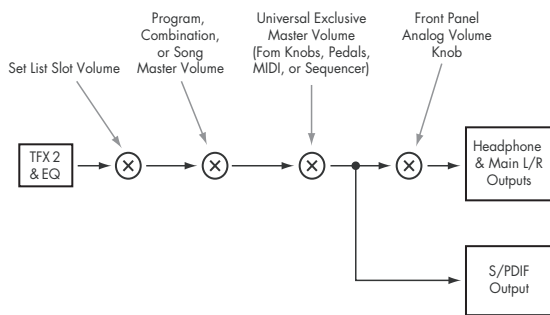

**Hold Time** [0...60 seconds]

This gives you extra control of how Smooth Sound Transitions work. The **Hold Time** controls how long reverbs, delays, and note releases continue to ring out after a new sound has been selected. This timer starts after all notes from the previous sound are no longer being held down, and the sustain pedal released

For other modes, the Global **Hold Time** parameter is used. In Set Lists, however, you can control this separately for every Slot. For instance, you might want a reverb to ring out a long time for one sound, but delays to fade away quickly for another.

Note that the Hold Time set here applies to the notes and effects of the current Slot, when transitioning into the next Slot.

For more information, see "Smooth Sound Transitions" on page 120 of the Operation Guide.

**Comment** [Text]

Each slot can have a comment of up to 512 characters, for lyrics, performance notes, and so on.

Pressing the text edit button brings up the text edit dialog box.

**1-1d: Slot Select**

**Slot Select** [000...127]

The 128 Slots are shown 16 at a time. To select a slot, simply touch it. For more information, see "0-1c: Slot Select" on page 664.

**1-1e: Cut, Copy, Paste, and Insert**

These buttons make it simple to re-arrange the Slots.

**Cut**

This places the selected Slot on the clipboard, removes it from its position in the list, and moves the rest of the list to fill in the now-empty space.

**Copy**

This places a copy of the selected Slot on the clipboard, leaving the original in place.

**Paste**

This replaces the selected Slot with the contents of the clipboard. Paste is only available if a Slot has already been Cut or Copied.

**Insert**

This places the contents of the clipboard in front of the selected Slot, moving the rest of the list to make room. Insert is only available if a Slot has already been Cut or Copied.

**Adding items to the Set List, from other modes**

Program, Combination, and Sequencer modes each have a command in their P0 page menus: **Add to Set List**.

When you use the **Add to set list** command, the current Program, Combination, or Song is inserted at the current Slot of the current Set List, similar to using the Set List Edit page's Insert command.

The parameters of the Slot are set as follows:

- The name of the Program, Combination, or Song is copied into the slot name. You can change this later if desired.
- If the item being copied is a song, the current Keyboard Track is copied into the slot's Keyboard Track parameter.

**▼ 1-1: Page Menu Commands**

The number before each command shows its ENTER + number-key shortcut. For more information on these shortcuts, see "ENTER + 0-9: shortcuts for menu commands" on page 147.

- **0: Write Set List.** For more information, see "Write Set List" on page 673.
- **1: Exclusive Solo.** For more information, see "Exclusive Solo" on page 147.
- **2: Initialize Set List.** The name changes depending on the type of the selected item. For more information, see "Initialize Set List" on page 673.
- **3: Edit Program/Combination/Song.** The name changes depending on the type of the selected item. For more information, see "Edit Program/Combination/Song" on page 673.
- **4: Update Program/Combination.** The name changes depending on the type of the selected item. For Songs, it is grayed out (or does not appear). For

more information, see "Update  
Program/Combination" on page 673.



## Set List P9: Control Surface

### 9–1: Control Surface

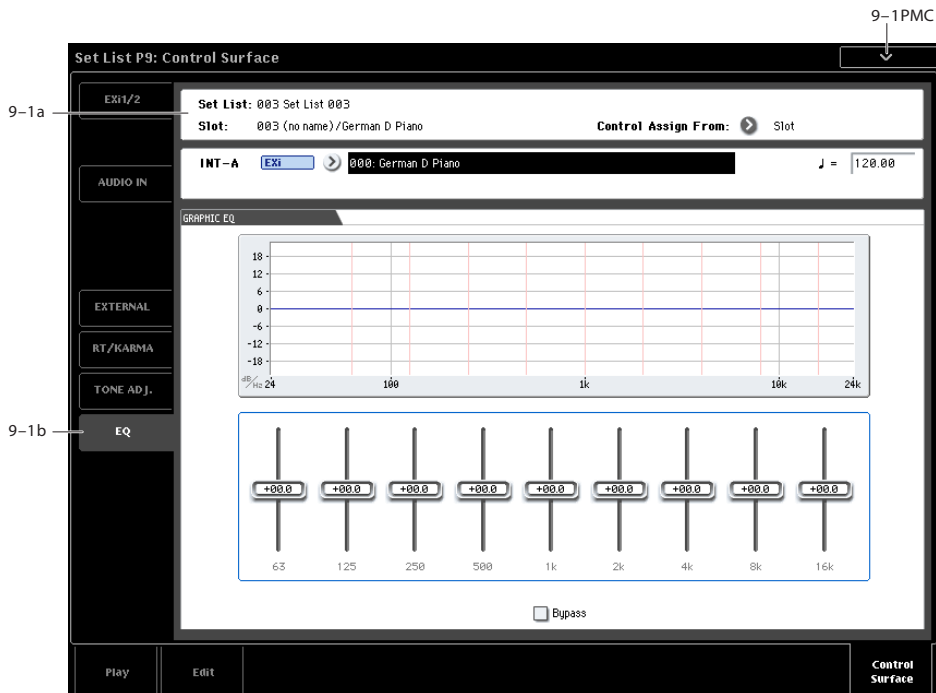

#### Overview

In general, the Control Surface works very similarly for Programs, Combinations, and Songs. However, there are some small differences between the modes, matching the different capabilities. For instance, Programs have three mixer channels (for the two oscillators or EXi, plus Drum Track), while Combinations and Songs have sixteen channels.

In Set List mode, the Control Surface updates to match the mode of the current Slot. For details on the Control Surface functionality in the different modes, see:

Programs: “0–9: Control Surface” on page 21

Combinations: “0–9: Control Surface” on page 428

Songs: “0–9: Control Surface” on page 534

#### Graphic EQ

Set Lists have an additional Control Surface option, not available in the other modes: EQ. This is a nine-band graphic EQ applied to the sound after TFX2, which tailors the sound from the main stereo outputs (including the analog L/R outputs, S/P DIF, and USB).

You can use this EQ to compensate for the acoustic environment of a specific club or other performance venue. The sliders are mapped to the nine bands of the EQ, for quick and intuitive adjustments.

For more information, see “9–1b: Graphic EQ” on page 671.

#### Saving edits

Any changes that you make via the Control Surface—such as editing mixer levels, tweaking the real-time knobs, or changing the Tempo—are temporary unless they are saved, just as they are in the other modes.

However, if you make changes that you’d like to keep, you can save your edits directly from Set List mode. To do so:

1. **Make your edits using the Control Surface.**
2. **In the page menu, select the command “Update Program” or “Update Combination.”**

The actual name will depend on whether the current Slot is a Program or Combination.

Songs work slightly differently, since they don’t have a Write command (and must be saved to disk). All edits made in Set List mode apply directly to the Songs in memory, and can be saved to disk as desired.

#### Timbre/Track shortcut not available

In Combination and Sequencer modes, there is a shortcut to select the current Timbre/Track using the TONE ADJ button in conjunction with the Control Surface buttons. This is not available in Set List mode; instead, the TONE ADJ button toggles between Tone Adjust and EQ.

#### 9–1a: Slot and Set List

##### Set List

[000...127]

This read-only parameter shows the name and number of the current Set List.

**Slot** [000...127]

This read-only parameter shows the name and number of the current Slot.

**Control Assign From** [Slot, Set List]

The Control Assign setting determines the functions assigned to the Control Surface, such as the mixer, Tone Adjust, KARMA and Real-Time Knobs, and so on.

**Control Assign From** sets whether the Control Assign applies to the Set List as a whole, and stays the same regardless of which Slot is selected, or instead changes according to the saved value for the Program, Combination, or Song in the current Slot.

For instance, you may wish to have the Control Surface stay assigned to the Set List EQ all the time. In this case, set **Control Assign From** to **Set List**.

Or, you may wish to have the Control Surface update to match the current Program, Combination, or Song. For instance, you might want to use Tone Adjust for drawbars on an organ Program, and then on the next slot use the sliders to control KARMA in a Combination. In that case, set **Control Assign From** to **Slot**.

**Program/Combination/Song Select** [List]

This shows the bank, number, and name of the Slot's Program or Combination, or the number and name of the Slot's Song (Songs don't have banks).

**♩ (Tempo)** [040.00...300.00, EXT]

This is the tempo of the current Program, Combination, or Song.

Note that this is not stored in the Set List itself; instead, it's stored in the original Program, Combination, or Song. If you change the tempo and want to keep your changes, you'll need to write the sound itself, and not the Set List. For more information, see "Saving edits" on page 670.

**9-1b: Graphic EQ**

This nine-band graphic EQ is applied to the sound after TFX2, and applies only to the main stereo outputs (including the analog L/R outputs, S/P DIF, and USB).

All bands are peaking, including the high and low bands.

There is a single graphic EQ setting for each Set List, which applies to all Slots in the list.

**EQ graphic display**

The graphic above the sliders shows the EQ curve.

**Bypass** [Check-box]

When enabled, this disables the EQ.

**63Hz Gain [dB]** [-18.0...+18.0]

This sets the gain for the 63Hz band.

**125Hz Gain [dB]** [-18.0...+18.0]

This sets the gain for the 125Hz band.

**250Hz Gain [dB]** [-18.0...+18.0]

This sets the gain for the 250Hz band.

**500Hz Gain [dB]** [-18.0...+18.0]

This sets the gain for the 500Hz band.

**1KHz Gain [dB]** [-18.0...+18.0]

This sets the gain for the 1kHz band.

**2KHz Gain [dB]** [-18.0...+18.0]

This sets the gain for the 2kHz band.

**4KHz Gain [dB]** [-18.0...+18.0]

This sets the gain for the 4kHz band.

**8KHz Gain [dB]** [-18.0...+18.0]

This sets the gain for the 8kHz band.

**16KHz Gain [dB]** [-18.0...+18.0]

This sets the gain for the 16kHz band.

**Setting the Control Surface to control the Graphic EQ**

The last button in the Control Assign section, TONE ADJ, has an additional option in Set List mode; pressing the button toggles the Control Surface between Tone Adjust and EQ.

Similar to the Timbre/Track and Audio buttons, the setting is indicated by LEDs to the right of the button. To set the Control Surface to control the Graphic EQ:

1. Press the TONE ADJ./EQ button until the EQ button is lit.

If you press another Control Assign button, and then press TONE ADJ./EQ again, the Control Surface returns to the function last selected for the button. For instance, if you last used it for EQ, then EQ will be selected.

As a shortcut, you can also touch the EQ graphic on the Set List Select page. This will jump to the Control Surface page, and set Control Assign to EQ.

**Reset Controls**

When on the EQ page, RESET CONTROLS + TONE ADJ./EQ resets all EQ parameters, including Bypass, to the stored values.

RESET CONTROLS + Slider resets the slider's band to the stored value.

**▼ 9-1: Page Menu Commands**

The number before each command shows its ENTER + number-key shortcut. For more information on these shortcuts, see "ENTER + 0-9: shortcuts for menu commands" on page 147.

- 0: **Write Set List**. For more information, see "Write Set List" on page 673.
- 1: **Exclusive Solo**. For more information, see "Exclusive Solo" on page 147.
- 2: **Initialize Set List**. The name changes depending on the type of the selected item. For more information, see "Initialize Set List" on page 673.

- **3: Edit Program/Combination/Song.** The name changes depending on the type of the selected item. For more information, see “Edit Program/Combination/Song” on page 673.
- **4: Update Program/Combination.** The name changes depending on the type of the selected item. For Songs, it is grayed out (or does not appear). For more information, see “Update Program/Combination” on page 673.

## Set List: Page Menu Commands

### Write Set List

This command writes the current Set List into the KRONOS internal memory. It's available on every page in Set List mode.

Write Set List lets you:

- Save your edits
- Rename the Set List
- Make a copy of the Set List to a different location in memory

#### 1. Select "Write Set List" to open the dialog box.

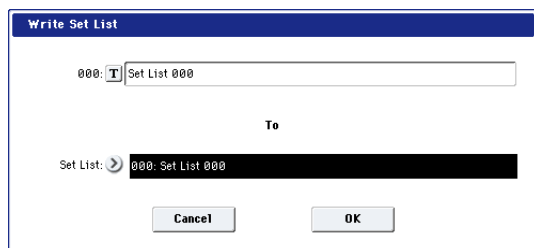

The upper line of the dialog shows the name of the Set List. To change the name:

#### 2. Press the text edit button to open the text edit dialog box, enter the desired name, and then press OK to confirm.

To write to a different Set List number (to make a backup copy, for instance):

#### 3. Press the Set List popup button, select the destination Set List number, and then press OK to confirm.

#### 4. To Write the Set List, press the OK button. To cancel, press the Cancel button.

-  Do not turn off the power for at least 10 seconds after using the **Write Set List** command. This allows the system time to complete the process, which includes saving a backup of the data to the internal disk.

### Shortcut: SEQUENCER REC/WRITE

You can also use the SEQUENCER REC/WRITE button to quickly update the current Set List, using the existing name and number. To do so:

#### 1. Press the SEQUENCER REC/WRITE button.

The Update Set List dialog will appear.

#### 2. Press OK to write the Set List.

### Initialize Set List

This brings up a confirmation dialog, with the text:

Initialize Set List: Are You Sure?

An OK button confirms the initialization; a Cancel button cancels the initialization.

When initialized, all 128 slots are set to the following:

**Type:** Program

**Bank and Number:** INT-A 000

**Slot Name:** Slot [slotNumber]; e.g. Slot 27

**Volume:** 127

**Keyboard Track:** 1

**Hold Time:** Global setting

The **Comment** field is left empty.

### Edit Program/Combination/Song

This command allows you to edit the current Program, Combination, or Song in its native mode.

To do so:

#### 1. Select the desired item in the Set List.

Next, from any of the Set List pages:

#### 2a. In the menu, select the Edit [Type] command.

The actual name of the command will be either **Edit Program**, **Edit Combination**, or **Edit Song**, depending on the selected Slot.

or:

#### 2b. Hold the ENTER button, and touch the Slot's button.

The mode will change to Program, Combination, or Sequence as appropriate, and the system will display the P0 page for the selected item.

The Program, Combination, or Sequence mode button's LED will blink, and the Set List LED remains solidly on, to show that you are editing an item in a Set List. The Set List settings, including EQ and volume, continue to affect the sound.

#### 3. Edit as desired.

#### 4. Write your edits.

#### 5. Press the SET LIST button to return to the Set List.

Set List mode will be as you left it, with the same Set List and Slot selected.

### Update Program/Combination

This allows you to save edits made via the front-panel controls (mixer settings, Tone Adjust, KARMA, tempo, etc.) without exiting Set List mode.



# Sampling mode

## Sampling Overview

The KRONOS can sample external audio from the analog, USB, or S/P DIF inputs, at 48 kHz 16-bit resolution (or 24-bit to disk), in mono or stereo. You can record samples into RAM, or sample directly to disk.

You can also digitally resample the complete sound of a Program, Combi, or Song, played live or sequenced, including any effects and KARMA-generated events.

Finally, you can also sample (or “rip”) directly from an audio CD, in the digital domain.

Once a sample is loaded into Sampling mode, you can use it directly in Drum Kits, or make it into a Multisample and use it anywhere that you use ROM Multisamples, including HD-1, STR-1, or MOD-7 Programs and Wave Sequences.

Once saved to disk, you can load your custom sounds as User Sample Banks, with access to Virtual Memory. For more information, see “User Sample Banks” on page 154 of the Operation Guide.

## Sampling to RAM, or direct to disk

### Sampling and RAM

The KRONOS comes with 2 GB of RAM pre-installed; the KRONOS X comes with 3 GB of RAM.

Approximately 1 GB of this RAM is used by the operating system and ROM sample data. The remainder is shared between the samples in EXs, User Sample Banks, and Sampling Mode.

This means that the size of the currently loaded EXs and User Sample Banks trades off against the memory available for Sampling Mode. The more space used by EXs and User Sample Banks, the less is available for Sampling Mode.

The amount of sampling time depends on the amount of free RAM, as shown below.

You can check the amount of available sample RAM on the P0 Recording page; for more details, see “0–1f: Free Sample Memory/Locations” on page 684.

*Free RAM and approximate sampling times*

Free RAM	Approximate Sampling Time (min:sec)	
	Mono	Stereo
16 MB	2:54	1:27
64 MB	11:39	5:49
128 MB	23:18	11:39
256 MB	46:36	23:18
512 MB	93:12	46:36

### Installing additional RAM

An additional 1 GB DIMM can be installed into the KRONOS at any authorized Korg service center, bringing the total physical RAM to 3 GB. (The KRONOS X ships from the factory with 3 GB already installed, and cannot be expanded further.)

The KRONOS uses widely available, off-the-shelf DIMMs. Installation by an authorized Korg service center is required; user installation is not supported and may void your warranty. For more information on how to purchase and arrange for installation of RAM, please contact your country’s Korg Distributor:

<http://www.korg.co.jp/English/Distributors/index.html>

For compatibility with the KRONOS, RAM must comply with the following specification:

240-Pin PC2-6400 CL-5 (or CL-6) DDR2-800 non-ECC Unbuffered DIMM 1GB

### Sampling to disk

You can sample directly to disk, creating a WAVE file. This lets you record up to 80 minutes continuously, in either mono or stereo (mono: approximately 440 MB, stereo: approximately 879 MB).

As long as they fit into the available RAM, these WAVE files can then be loaded into Sampling mode and used in HD-1, STR-1, or MOD-7 Programs, Drum Kits, or Wave Sequences.

WAVE files can also be used in audio tracks of the sequencer, or used to create an audio CD. For more information, see the Operation Guide under “Audio recording” on page 89, and “Creating and playing audio CDs” on page 195.

When sampling to disk, you can choose to record at either 16- or 24-bit resolution. 24-bit files can be used at full resolution in audio tracks; when loaded into Sampling mode, they are automatically converted to 16-bit data.

 Do not turn off the power for at least 10 seconds after sampling to disk. This allows the system time to complete the process.

## Sampling features

### Sampling on the KRONOS

The KRONOS features Korg's Open Sampling System. This lets you use sampling and resampling not only in Sampling mode but also in Program, Combination, and Sequencer modes, with optimized features for each mode.

- You can perform 48 kHz 16-bit linear mono or stereo sampling (or 24-bit, when sampling to disk).
- A maximum of 4,000 multisamples and 16,000 samples can be created.
- In Disk mode, you can load multisample/sample data from various types of media.
- You can load several different sample formats, including Korg's own format, Akai S1000/3000 and SoundFont 2.0 samples and program data, and AIFF or WAVE samples.
- You can export samples created on the KRONOS as AIFF or WAVE files.
- You can use all of the Insert, Master, and Total effects to process signals before sampling, from either internal or external sources. For instance, you can use compression, EQ, decimation, etc. You can also use tempo-based LFO or delay effects, which can be very useful when sampling rhythmic loops.
- Sampling can be initiated by the front-panel SAMPLING or SEQUENCER START/STOP switches, note-on, or threshold. (The available methods will depend on the mode.) Threshold allows you to start sampling when the input signal exceeds a specified level. In Sampling mode, you can also capture sound *before* the trigger.
- The analog audio inputs support mic and line level signals. The S/P DIF digital audio input supports the 48 kHz sample rate.

- You can digitally sample (i.e., "rip") audio data from an audio CD, using either internal or external CD-R/RW drives.
  - Sampled data can be automatically converted into an HD-1 Program. It can then be edited and played just like any other Program, including processing with filters and effects. You could even re-sample that Program, and start all over again...
  - Multisamples can be used in Wave Sequences.
  - Individual samples can also be used in drum kits.
- ⚠ When you turn off the power, all multisample and sample data in RAM memory will be lost. Before you turn off the power, be sure to save important data to disk. You can use the KSC Auto-Load feature to automatically load sets of samples at startup; for more information, see "0-3: KSC Auto-Load" on page 762.
- ⚠ If **Auto Optimize RAM** (Global 0-1d) is on, and the writing destination for sampling data is RAM, the RAM memory will automatically be optimized after the data has been written. This is turned on by default, but you may switch it on/off as necessary. For more information, see "Auto Optimize RAM" on page 757, and "Optimize RAM" on page 731.

### Editing in Sampling mode

- In Sampling mode, the sample data you sampled or loaded from various media (including WAVE and AIFF formats) can be assigned to an index (zone) to create a multisample.
- The waveform can be viewed in the LCD screen, and edited by a variety of commands including rate conversion (down-sampling) and reverse playback.
- Start, loop start, and end addresses can be specified in single-sample units. Loop tune, reverse playback, and loop lock functions are also supported.

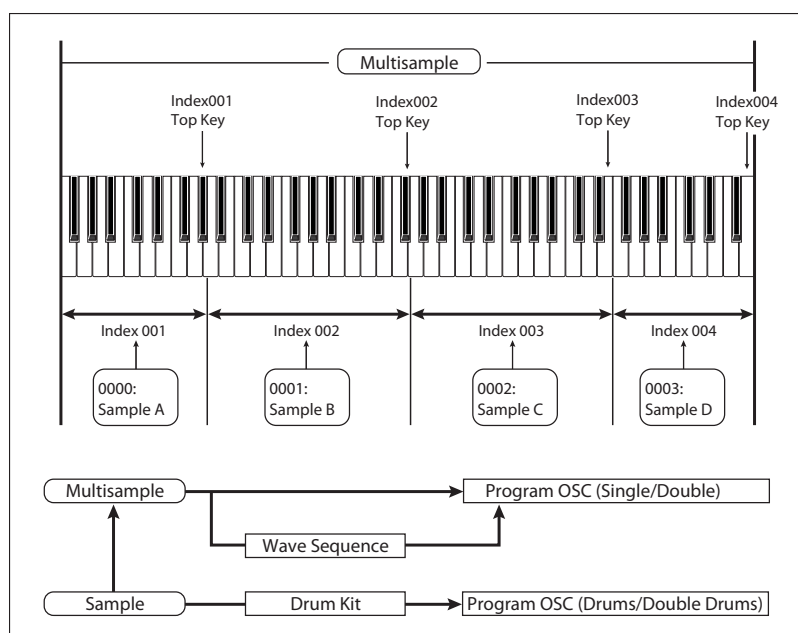



- The Use Zero function automatically searches for zero-cross points, making it easy to find the beginning or end of the waveform, or locations that will not produce noise when the sample is played back.
- The grid function displays a BPM-based grid on the waveform display, helping you to create loops or make waveform edits that match the desired BPM. At this time, you can set the BPM value by pressing TAP TEMPO in rhythm with the sample playback.
- Each multisample allows you to create up to 128 indices. Each index consists of a sample assignment, a key zone, an original key, a playback pitch, and settings such as level.
- The “Keyboard & Pad” display lets you edit a multisample while viewing the assignments and zones of each sample.
- Sample names and multisample names can be assigned. Sample names and multisample names can also be viewed in Disk mode (see “Translation” on page 828).
- The **Time Slice** function automatically detects the attack portions of a kick or snare etc. in a rhythm loop sample (a looped pattern of drums etc.), and divides it into separate rhythm instrument sounds. Either stereo or mono samples can be used. A pattern corresponding to the divided samples is created automatically, so that you can immediately use the Sequencer mode RPPR function to play the pattern and adjust the tempo without changing the pitch. You can also do things such as adjusting the pitch of only the snare, replacing it with a different sample, or changing the playback timing on the sequencer, in this way creating a new rhythm loop based on the one you started with.
- The **Time Stretch** function lets you modify the tempo without changing the pitch of a sample. You can select either Sustaining (suitable for sustain-type instruments such as strings or vocals), or Slice (suitable for rhythm loops on decay-type instruments such drums). Stereo samples are supported.
- The **Crossfade Loop** function is an important looping tool that helps smooth out irregularities in long loops which contain complex material. By executing Crossfade Loop, you can eliminate this problem and create natural-sounding loops.
- The **Link** (with **Crossfade**) function allows you to join two samples into a single sample. You can also crossfade the overlapping portion of the samples at this time, so that the volume changes gradually, producing a natural-sounding transition.
- The **BPM Adjust** function (playback pitch adjust) lets you adjust the playback pitch of each index so that the loop frequency matches the desired BPM value.
- You can use resampling (auto) to automatically apply effects to a sample and create a new sample.
- A multisample you create can easily be converted into a program (**Convert MS To Program**).
- In Sampling mode, the selected multisample or sample will sound when you play the keyboard,

allowing you to hear the edited content of that page.

---

## Sampling in Program, Combination, and Sequencer modes

- A performance in Program, Combination, or Sequencer modes can be resampled internally, with all audio remaining in digital form. This lets you resample a performance that uses the KRONOS’s filters, effects, KARMA, and sequencer etc.
- External audio sources from the various input jacks can be sampled. A performance played on the KRONOS can be mixed with the external audio source and sampled, or you can sample just the external audio source while monitoring the performance played on the KRONOS.
- In Sequencer mode when you sample an external audio source while listening to the playback of the song, note data will be automatically created in the track. You can use this In-Track Sampling function to sample vocals or guitar while the sequencer is running.
- You can resample the Sequencer mode song playback to the hard disk, use Disk mode to edit the desired order of songs, and then use an external USB CD-R/RW drive to create an audio CD.

---

## Note: Changing velocity on the keyboard

In Sampling mode, you cannot use velocity to control the loudness of the sound. However, you will be able to use velocity to control effects if you select Velocity as a Dmod Source.

For example, you might make settings as follows.

Bus Select **All OSC to:** IFX1 (P8– Routing)

IFX1: 005: Stereo Limiter, On (P8– Insert FX)

Stereo Limiter:

**Ratio** 1.0:1

**Gain Adjust [dB]** -Inf

**Source:** Velocity or Exponential Velocity

**Amount** +40

If you are converting a user multisample into a program for use in Program mode, you can raise the P4: Amp/EQ– Amp1/2 Modulation “Velocity Intensity” value as desired to control the sound.

### Sampling frequency and bit resolution

As shown in the diagram below, sampling reads the level of the analog signal at fixed intervals along the time axis, and stores the levels in memory as digital data.

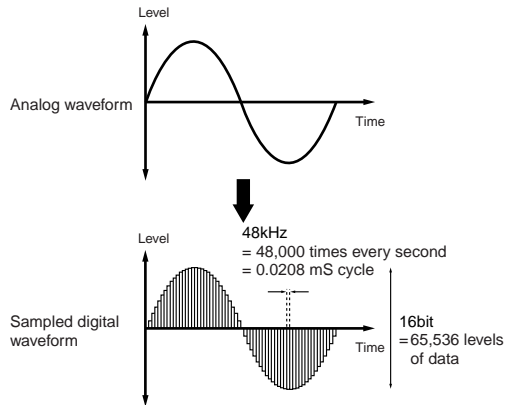

These “fixed intervals” are generally expressed as the “sampling frequency.” 48 kHz (kilohertz) means that sampling is performed 48,000 times each second, and that the interval is  $1 \text{ (second)} / 48,000 \text{ (times)} =$  approximately 0.00002083 (seconds) = approximately 0.02083 ms (milliseconds).

The higher the sampling frequency is, the closer to the original analog signal the waveform in memory will be.

Each level is read, and converted into digital data. The accuracy at this time is determined by the bit resolution. This process converts an analog signal with infinite resolution into a digital signal with finite resolution. With 16 bit resolution, each level is indicated in 65,536 steps (the sixteenth power of two).

The greater the bit resolution is, the closer to the original analog signal the waveform in memory will be.

48 kHz 16 bit sampling is the same quality as in audio devices such as DAT. CDs use 44.1 kHz 16 bit sampling, which is a slightly lower sampling frequency.

## Sampling P0: Recording

This page is where you make basic settings for recording (sampling), including:

- Creating and editing multisamples and indexes
- Specifying the writing-destination for the samples you record, and selecting either mono or stereo samples
- Specifying the sampling time, loop settings, and +12dB boost
- Specifying the output destinations for the external audio inputs
- Selecting the source to sample
- Setting the recording level

### 0-1: Recording

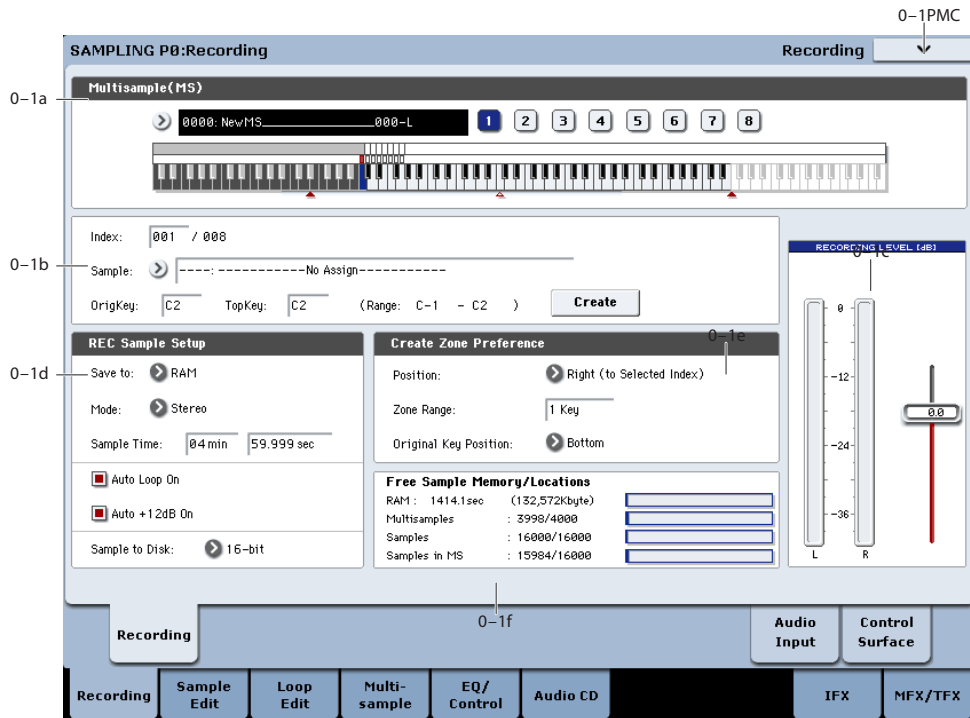

Here you can create and edit multisamples and indexes, specify the write-destination for newly recorded samples, and select stereo or mono sampling. You can also specify the sampling time, loop settings, +12dB boost, and adjust the final level of the input signal.

While you can record samples on any of the pages in Sampling Mode, this page is particularly convenient due to its level meter, memory display, and basic setup parameters.

*Note:* If you're recording from the audio inputs, make sure that you've set things up correctly on the Audio Input page. For more information, see "0-8: Audio Input" on page 685.

#### 0-1a: Multisample Select (MS)

**Multisample Select (MS)** [0000...3999]

Selects the multisample.

Each multisample consists of the samples for one or more indexes (an **Index** is a range or zone of keys).

This parameter can also be set from P1-P3.

#### Creating a new sample

To create a new multisample,

1. Press the "Multisample Select" popup button to access the popup menu.
2. Select a number for which the multisample name is blank.

Alternatively, use the numeric keys 0-9 to specify a new multisample number, and press the ENTER switch.

When you select a new multisample number, the **Create New Multisample** dialog box will appear.

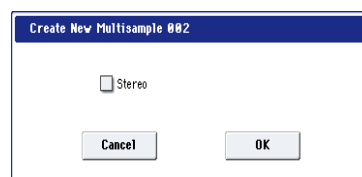

3. If you wish to create a stereo multisample, check "Stereo."
4. To create the multisample, press the OK button. To cancel, press the Cancel button.

A multisample will be created as follows (example).

Mono 0001: NewMS\_\_\_\_\_001  
 Stereo 0001: NewMS\_\_\_\_\_001-L  
 0002: NewMS\_\_\_\_\_001-R

Keyboard & Pads

Keyboard & Pads

**Keyboard:** This shows the key range, original key, and root key for the selected index. The red triangles indicate the keyboard range, and the white triangle indicates the C4 key.

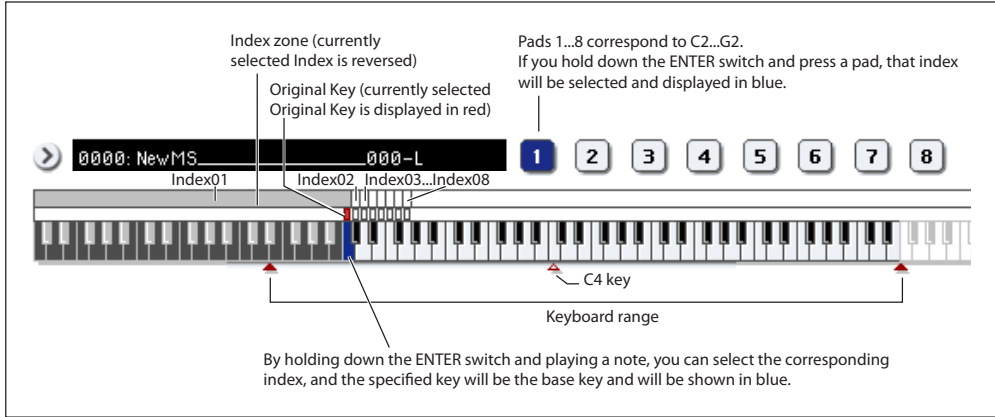

*Note: The base key (displayed in blue)*

- In P1: Sample Edit you can press the SAMPLING START/STOP switch to play the sample of the selected **Index** in one-shot mode from **Start** to **End**. At this time, the sample will sound at the pitch of the base key.
- Playback in the grid display of P1 and P2 will be according to the playback pitch of the base key selected here, and the specified tempo BPM/resolution (set in P1 and P2).
- The **Pitch BPM Adjust** menu command is based on the playback pitch of the base key you specify here.

**Pads:** By default, pads 1–8 are assigned to C2–G2. When you choose an index to which a pad is assigned, it is displayed in blue. The index zone, original key, and base key of the pads can be viewed and edited in the keyboard display or in 0–1b.

**0–1b: Index, Sample Select, Original Key, Top Key, Create**

Here you can set the sample, original key, and range of the selected index.

**Index** [xxx (001...128)/yyy (001...128)]

This selects the index to view and edit.

Each zone in a multisample is called an **Index**. For example on the 73-note keyboard, a multisample could be divided into seven zones of one octave (12 keys) each. Each of these zones is referred to as an **Index**. You will assign a sample to each of these indexes.

**xxx:** The selected index. Choose the desired index.

**yyy:** The total number of indexes in the multisample.

*Note:* You can also select an index by holding down the ENTER switch and playing a note on the keyboard. The index that includes this note will be selected. The key you specify will be the base key, and will be displayed in blue in the keyboard graphic.

This parameter can also be set from P1–P3: Multisample. Sampling and editing in the respective page will apply to the index that you select here.

Immediately after the power is turned on, this will be 001/008. This indicates that there are eight indexes, and that currently the first index is selected.

To increase the number of indexes, use **Create** in this page. When you press the Create button, indexes will automatically be added from the left-most zone, as 002/002, 003/003, ... (The position, zone width, and original key location of the index that is created when you press the Create button can be set in Create Zone Preference (0–1e, 3–1c). You are also free to modify the zone width and original key location later.)

**Sample Select** [----: ---No Assign----, 00000...15999]

Selects a sample that you sampled or loaded in Disk mode, and play a note within the index range to sound that sample. The sample you select here is the sample that will be affected by your sampling and editing operations in the various pages. This parameter is also available in P1–P3.

----: ---No Assign----: No sample is assigned to the index. There will be no sound when you play the keyboard.

To record a sample, select a vacant sample such as 00000:. When you record a sample, data will be loaded into the selected sample. The sample name (such as NewSample\_00000) will be shown beside the number. This sample name can be modified using the **Rename Sample** menu command.

You can also record a sample even when ----:---No Assign---- is displayed. In this case, a sample number will be selected automatically.

Even if you record to a sample that already contains data, the selected sample will not be overwritten –the data will automatically be sampled to a vacant sample, and the newly recorded sample will replace the previous sample in the index. If you wish to delete a sample, execute the **Delete Sample** menu command.

**Original Key****[C-1...G9]**

Specifies the key that will play the sample at its original pitch (i.e., the pitch at which it was recorded). The pitch will change in semitone steps relative to the original key.

For example, suppose that you recorded a sample with **Original Key** of F2. When the zone of the index is C2–B2, pressing the F2 key would playback the sample at its original pitch. Pressing F#2 would playback the sample a semitone higher. Pressing E2 would playback the sample a semitone lower. The pitch of this sampled sound will change in semitone steps between C2 and B2, centered at F2.

The original key location can also be viewed in “Keyboard & Pads.”

*Note:* If **Constant Pitch** (3-1b) is checked, the sample will be sounded at its original pitch by all notes in the zone.

**Top Key****[C-1...G9]**

Specifies the highest key in the zone of the index. The zone is defined by this **Top Key**.

For example, suppose that you set a **Top Key** of B2 for index 001/002, and a **Top Key** of B3 for index 002/002. This means that the zone of index 001 will be B2 and lower, and the zone of index 002 will be C3–B3.

**Range**

This indicates the zone (area) that was determined by the **Top Key** setting.

The sample selected by **Sample Select** will sound in this area. The zone for each index can also be viewed in “Keyboard & Pads.”

**Create**

This creates an index. Use this when you wish to add a sample to a multisample.

When you press the Create button, a new index will be created according to the Create Zone Preference (0-1e, 3-1c) parameters **Position**, **Zone Range**, and **Original Key Position**.

If you wish to delete an index or exchange indexes, use P3: Multisample Edit.

⚠ If when you execute **Create** (0-1b, 3-1b) or **Insert** (3-1b) it is not possible to create a new index according to your Create Zone Preference settings, one of the following dialog boxes will appear. If you wish to create a new index, perform the following procedure.

- **Set Top Key:** Select **Index** 001, set **Position** (0-1e, 3-1c) to Left (to Selected Index), and execute **Create** or **Insert** to open the dialog box. So that a new index can be created at the left of index 1, re-set the **Top Key** setting, and press the OK button.

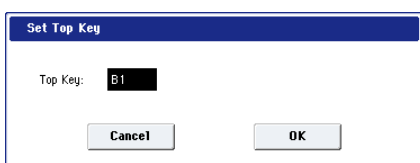

- **Set Zone Range:** If you execute **Create** when it is not possible to create a new index according to the Create Zone Preference settings, the following dialog box will appear. This dialog box will also appear if you execute **Insert** when it is not possible to create a new index with the contents of the **Cut** or **Copy**. Re-set the **Zone Range**, and press the OK button.

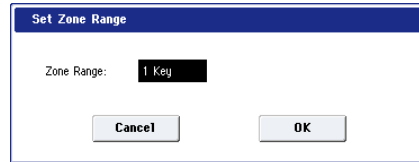
**Stereo**

A **Stereo** indication will appear here if you have selected a stereo multisample or sample, or if you recorded a sample with **Mode** (0-1d) set to Stereo.

**About stereo multisamples and stereo samples**

**Stereo multisamples:** Under the following conditions, two multisamples will be handled as a stereo multisample.

- If you checked **Stereo** when creating a new multisample (i.e., selected a new multisample in **Multisample Select** 0-1a)
- If you executed the **MS Mono To Stereo** page menu command
- If you sampled with **Mode** (0-1d) set to Stereo

In these cases, a stereo multisample will be created automatically using the following criteria.

- 1) The last two characters of the two multisample names will be -L and -R respectively, and the earlier portion of the names are identical.
- 2) The two multisamples will have the same number of indexes, and their zone settings are identical.

**Stereo samples:** Under the following condition, two samples will be handled as a stereo sample.

- When the samples were recorded with **Mode** (0-1d) set to **Stereo**
- If you executed the **Sample Mono To Stereo** page menu command

In these cases, a stereo multisample will be created automatically using the following criteria.

- 1) The last two characters of the sample name will be -L and -R respectively, and the earlier portion of the names are identical.
- 2) Two samples that satisfy condition 1) for stereo multisamples are selected.

⚠ Stereo multisamples and samples are distinguished internally by their names. If you use **Rename MS** or **Rename Sample** menu commands to modify multisample or sample names, please pay attention to the above conditions.

⚠ As a condition of a stereo sample, the sampling rates must be identical. You can verify the sampling rate of a sample by using the page menu command “Rate Convert.” Be aware that if you use **Rate**

Convert to convert the -L and -R samples to differing sampling rates, they will no longer be handled as a stereo sample.

**ADC OVERLOAD !**

If the signal level from AUDIO INPUT 1 & 2 jacks is too high, the "ADC OVERLOAD !" indication will appear. You'll need to adjust the MIC/LINE gain select switch, the LEVEL knobs, or the output level of your external audio source.

**0-1c: Recording Level [dB]**

**Recording Level [-Inf, -72.0...+18.0]**

This adjusts the signal level at the final stage of sampling.

For more information, see "Setting levels" on page 16, "Tips for eliminating distortion when using the analog inputs" on page 17, and "Avoiding extraneous noise" on page 16.

**Level Meter**

This adjusts the signal level at the final stage of sampling. This setting can also be made in the P0-Audio Input page.

The meter is active only during standby mode (after pressing the SAMPLING REC switch) and recording.

**CLIP !**

If 0 dB is exceed, the display will indicate "CLIP !" This means that the level of the sampling signal is too high, so adjust the level as described under "Setting levels" on page 16.

Note: If you have sampled at a low input level, you can use the **Normalize/Level Adj.** menu command to amplify the level to the maximum possible without clipping. For more information, see "Normalize/Level Adjust" on page 737.

**0-1d: REC Sample Setup**

**Save to [RAM, DISK]**

Specifies the destination to which the data will be written during sampling.

**RAM:** The sound will be sampled into RAM for use in Sampling mode.

You can check the remaining amount of RAM in the section labeled "0-1f: Free Sample Memory/Locations," as described on page 684.

Note: The amount of RAM available for user sampling will vary depending upon both the amount of physical RAM installed, and the size of the currently loaded EXs banks. For more information, see "Sampling and RAM" on page 675.

⚠ Data written into RAM will be lost when the power is turned off, so you must save it if you want to keep it.

**DISK:** The sound will be recorded to disk as a WAVE file. You can select a disk (internal or USB), directory, and name for the recorded file using the **Select Directory/File for Sample to Disk** menu command.

Once recorded, you can audition the sample directly from the **Select Directory/File for Sample to Disk** window; just select the file and press the on-screen **Play** button or the front-panel **SAMPLING START/STOP** switch. To stop playback, either press the **SAMPLING START/STOP** switch again, or touch the on-screen **Stop** button.

If the sample will fit into RAM, you can also load it into Sampling Mode (using the **Load** command in Disk mode).

⚠ You cannot load a disk sample (WAVE file) that exceeds the amount of available RAM.

**Mode [L-Mono, R-Mono, Stereo]**

Specifies the channel(s) that you want to sample, and specify whether a mono or stereo sample will be created. For more information, see "Source Bus" on page 687.

*Audio input/output*

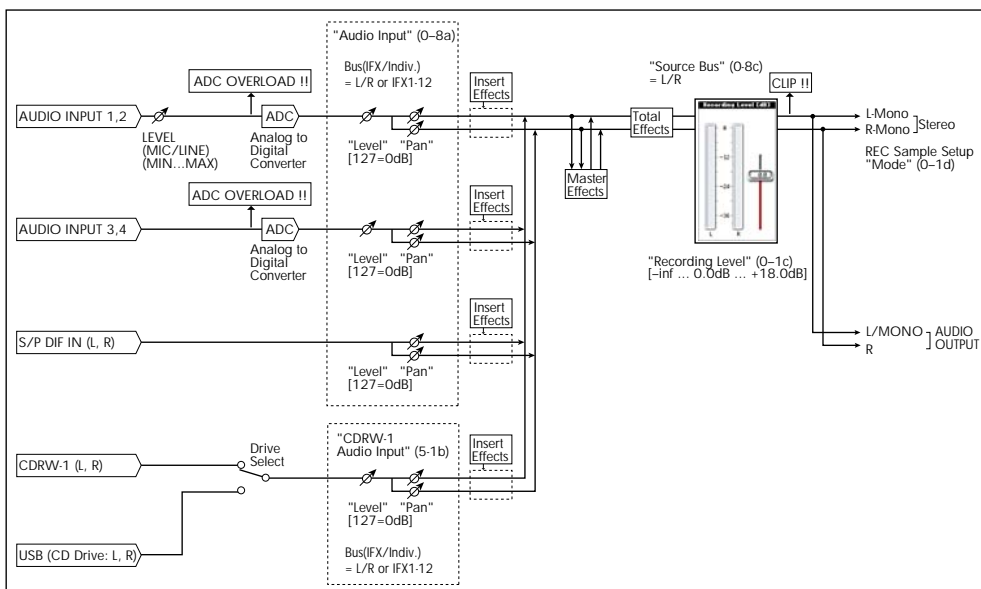



**L-Mono:** The L channel of the **Source Bus** will be sampled in mono.

**R-Mono:** The R channel of the **Source Bus** will be sampled in mono.

**Stereo:** The L and R channels of the **Source Bus** will be sampled in stereo, creating a stereo multisample.

### Sample Time [min sec]

Specifies the amount of time that you wish to sample, in 0.001 second increments.

Immediately after the power is turned on, this parameter indicates amount of remaining RAM memory in the selected memory bank (the available sampling time). If you record a sample in this condition ([REC]→[START]→[STOP]), the change in time will be displayed automatically.

If **Save to** is set to **DISK**, the maximum value is calculated from the amount of remaining space on the selected disk.

*Tips:* If you have sufficient RAM memory, it is a good idea to set an ample "Sample Time," and to use the "Truncate (for Sample Edit)," "Truncate (for Loop Edit)" page menu command after you sample to delete unwanted portions of the sample and reduce it to the minimum size necessary. You can also press the SAMPLING START/STOP switch to manually stop sampling after you have recorded the desired material.

For more details on sampling please see "Sampling (Open Sampling System)" on page 123 of the Operation Guide.

- ⚠ If **Save to** is set to RAM, and you continue sampling with **Auto Optimize RAM** disabled, wasted space will develop in memory, decreasing the amount of available RAM. In this case, use the **Optimize RAM** command to recover the wasted space. For more information, see "Optimize RAM" on page 731.

*Note:* "Free Sample Memory/Locations" (0-1f) lets you check the remaining amount of RAM.

The remaining amount of memory will depend on the following conditions:

- The amount of memory that is installed.
- The size of any loaded EXs samples.
- Whether sampling in stereo or in mono. If **Mode** (0-1d) is set to Stereo, the maximum "Sample Time" will be halved.
- The time specified for "Pre Trigger REC" (0-8c: a function that automatically samples the sound even before you begin sampling) will be subtracted from the amount of memory that actually remains.

### Auto Loop On [Off, On]

**On (checked):** Looping will automatically be enabled for newly recorded samples. For more information, see "Loop (Loop On)" on page 701.

### Auto +12dB On [Off, On]

On playback, samples are normally reduced in volume by 12dB, to reduce the chance of clipping when playing many voices simultaneously. This parameter lets you defeat the volume reduction for individual samples, when desired.

In general, **+12dB** should be On for drums and loops (so that they play at the same level as they were recorded), and Off for any sounds that you play polyphonically. For more information, see "+12dB" on page 701.

**On (checked): +12dB** will automatically be enabled for newly recorded samples.

**Off (unchecked): +12dB** will not be enabled for newly recorded samples. You can still enable it manually for individual samples as desired, at any time. This is the default setting.

This setting applies only when **Save to** is set to **RAM**. It does not apply if **Save to** is set to **DISK**.

*Note:* **Auto +12 dB On** is set separately for each mode: Program, Combination, Sequencer, and Sampling. In Sampling mode, **Auto +12 dB On** is disabled by default.

### Sample to Disk [16-bit, 24-bit]

This sets the bit depth for sampling to disk. Note that this does not affect sampling to RAM. This same parameter appears on the sampling setup pages in Program, Combination, Sequencer, and Sampling modes; changes in one place are reflected everywhere.

The resulting 24-bit files can be used at full resolution in audio tracks. When loaded into Sampling mode, they are automatically converted to 16-bit data.

### Sampling examples

#### Example: Sampling a mono source connected to AUDIO INPUT 1

If using the Audio Input:

**Source Bus:** Audio Input 1/2 (0-8c)

**Resample:** Manual (0-8c)

**Recording Level [dB]:** as desired (0-1c)

**Mode:** L-Mono (0-1d)

(→ see diagram in 0-8c: Source Bus = Audio Input 1/2)

If using the L/R Bus:

**Input1 Bus Select (IFX/Indiv.):** L/R (0-8a)

**Input1 Pan:** L000 (0-8a)

**Input1 Level:** 127 (0-8a)

**Source Bus:** L/R (0-8c)

**Resample:** Manual (0-8c)

**Recording Level [dB]:** as desired (0-1c)

**Mode:** L-Mono (0-1d)

(→ see diagram in 0-8c: Source Bus = L/R)

#### Example: Sampling a mono input, with internal stereo effects

Here, we'll apply the internal insert effect 101: Reverb Hall to a mono source connected to AUDIO INPUT 1, and then sample in stereo.

**Input1 Bus Select (IFX/Indiv.):** IFX1 (0-8a)

**Input1 Pan:** C064 (0-8a)

**Input1 Level:** 127 (0-8a)

**Source Bus:** L/R (0-8c)



**Resample:** Manual (0–8c)

IFX1: select 101: Reverb Hall (P8)

**Recording Level [dB]:** as desired (0–1c)

**Mode:** Stereo (0–1d)

(→ see diagram in 0–8c: Source Bus = L/R)

### **Example: Sampling a stereo source connected to AUDIO INPUTS 1 and 2**

If using the Audio Input:

**Source Bus:** Audio Input1/2 (0–8c)

**Resample:** Manual (0–8c)

**Recording Level [dB]:** as desired (0–1c)

**Mode:** Stereo (0–1d)

(→ see diagram in 0–8c: Source Bus = Audio Input1/2)

If using the L/R Bus:

**Input1 Bus Select (IFX/Indiv.):** L/R (0–8a)

**Input1 Pan:** L000 (0–8a)

**Input1 Level:** 127(0–8a)

**Input2 Bus Select (IFX/Indiv.):** L/R (0–8a)

**Input2 Pan:** R127 (0–8a)

**Input2 Level:** 127 (0–8a)

**Source Bus:** L/R (0–8c)

**Resample:** Manual (0–8c)

**Recording Level [dB]:** as desired (0–1c)

**Mode:** Stereo (0–1d)

(→ see diagram in 0–8c: Source Bus = L/R)

### **Example: sampling a stereo input, with internal effects**

Here, we'll apply the internal effect 012: St.Graphic 7EQ to a stereo source connected to AUDIO INPUTS 1 and 2, and then sample in stereo.

**Input1 Bus Select (IFX/Indiv.):** IFX1 (0–8a)

**Input1 Pan:** L000 (0–8a)

**Input1 Level:** 127 (0–8a)

**Input2 Bus Select (IFX/Indiv.):** IFX1 (0–8a)

**Input2 Pan:** R127 (0–8a)

**Input2 Level:** 127 (0–8a)

**Source Bus:** L/R (0–8c)

**Resample:** Manual (0–8c)

IFX1: select 012: St.Graphic 7EQ (P8)

**Recording Level [dB]:** as desired (0–1c)

**Mode:** Stereo (0–1d)

(→ see diagram in 0–8c: Source Bus = L/R)

### **Example: Sampling from the S/P DIF input**

**Source Bus:** S/P DIF L/R (0–8c)

**Resample:** Manual (0–8c)

**Recording Level [dB]:** as desired (0–1c)

**Mode:** Stereo (0–1d)

(→ see diagram in 0–8c: Source Bus = S/P DIF L/R)

*Note:* For details on resampling, see “Resample” on page 688.

---

## **0–1e: Create Zone Preference**

These settings define the initial state of the indexes that are created when you press the Create button (0–1b, 3–1b). Each new index will be created according to the settings you make here, but you are free to modify the settings later.

### **Position [Right (to Selected Index), Left (to Selected Index)]**

Specifies whether the new index will be created at the right or left of the selected index.

**Right (to Selected Index):** The new index will be created at the right of the currently selected index.

**Left (to Selected Index):** The new index will be created at the left of the currently selected index.

### **Zone Range [1 Key...127 Keys]**

Specifies the key range of the newly created index.

**1 Key:** Each individual note of the keyboard will be an index. The sample of an index will sound at its original key when you play that note.

**2 Keys–127 Keys:** The sample will change pitch in semitone steps across the specified number of keys, centered on the original key **Original Key** (0–1b, 3–1b). If **Constant Pitch** (3–1b) is checked, the pitch will not change.

### **Original Key Position [Bottom, Center, Top]**

Specifies where the original key will be located in the zone (specified by “Zone Range”) for a newly created index.

**Bottom:** The lowest key in the zone will be the original key.

**Center:** The middle key in the zone will be the original key.

**Top:** The top key in the zone will be the original key.

---

## **0–1f: Free Sample Memory/Locations**

### **RAM [000.0...999.9 sec]**

This shows the remaining amount of sample RAM, in both seconds and bytes. The free RAM determines the available sampling time, the maximum size of sample files that can be loaded in Disk mode, and the maximum size of samples during editing. The graph to the right shows the free space in white, and the used space in blue.

Note that the amount of RAM available for user sampling will vary depending upon both the amount of physical RAM installed, and the size of the currently loaded EXs banks.

**Multisamples** [0000...3999/4000]  
**Samples** [00000...15999/16000]  
**Samples in MS** [00000...15999/16000]

These show the number of multisamples and samples in RAM, as well as the number of samples which are already placed in multisamples. The current numbers are shown on the left, and the maximum numbers are shown on the right.

The graphs to the right show the free amounts in white, and the used amounts in blue.

### ▼ 0–1: Page Menu Commands

The number before each command shows its ENTER + number-key shortcut. For more information on these shortcuts, see “ENTER + 0-9: shortcuts for menu commands” on page 147.

- 0: **Delete Sample**. For more information, see “Delete Sample” on page 726.
- 1: **Copy Sample**. For more information, see “Copy Sample” on page 727.
- 2: **Rename Sample**. For more information, see “Rename Sample” on page 727.
- 3: **Move Sample**. For more information, see “Move Sample” on page 727.
- 4: **Sample Mono To Stereo**. For more information, see “Sample Mono To Stereo (Change Sample Type)” on page 728.

- 5: **Delete MS**. For more information, see “Delete MS (Delete Multisample)” on page 728.
- 6: **Copy MS**. For more information, see “Copy MS (Copy Multisample)” on page 729.
- 7: **Rename MS**. For more information, see “Rename MS (Rename Multisample)” on page 729.
- 8: **Move MS**. For more information, see “Move MS (Move Multisample)” on page 730.
- 9: **Convert MS To Program**. For more information, see “Convert MS (Multisample) To Program” on page 729.
- 10: **MS Mono To Stereo**. This will appear only if the current MS is Mono. For more information, see “MS Mono To Stereo/MS Stereo To Mono (Change Multisample Type)” on page 730.
- 10: **MS Stereo To Mono**. This will appear only if the current MS is Stereo. For more information, see “MS Mono To Stereo/MS Stereo To Mono (Change Multisample Type)” on page 730.
- 11: **Optimize RAM**. For more information, see “Optimize RAM” on page 148.
- 12: **Select Directory**. This applies only when **Save to** is set to **Disk**. For more information, see “Select Directory” on page 149.
- 13: **Auto Sampling Setup**. For more information, see “Auto Sampling Setup” on page 731.

## 0–8: Audio Input

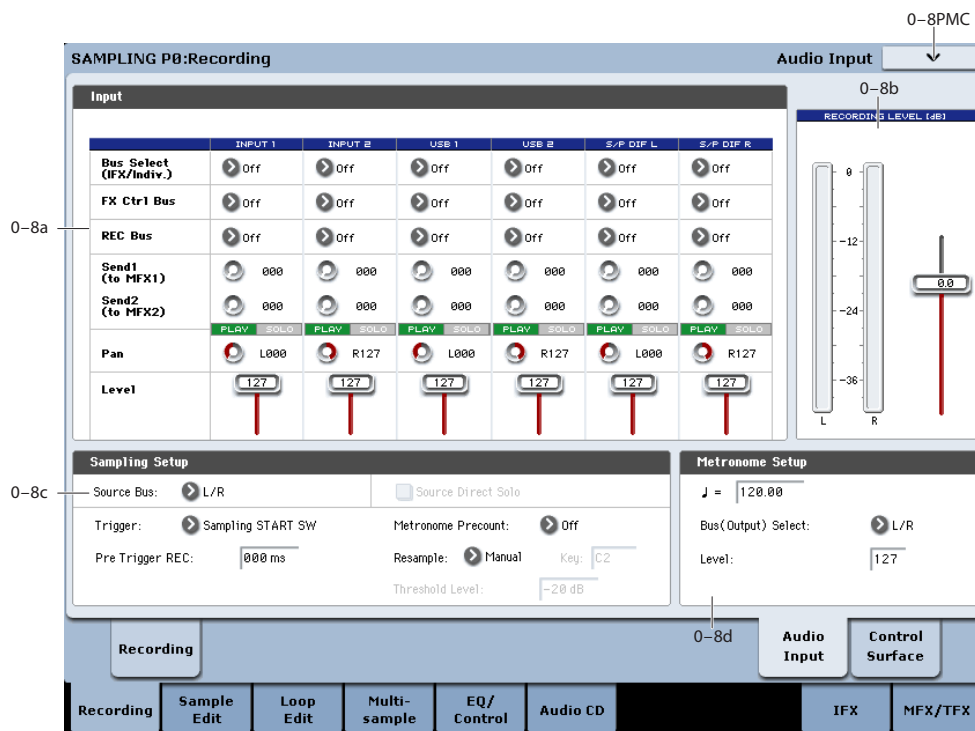

Here you can specify the output destination and input level etc. for the external audio signals being input from the INPUT jacks. Here you can also specify the

source that will be sampled, and specify how sampling will be initiated. You can also specify a metronome count-down before sampling begins.

**Using the control surface to adjust Audio Input**

You can use the control surface to adjust the Audio Input **Send1 (to MFX1)**, **Send2 (to MFX2)**, **PLAY/MUTE**, **Solo On/Off**, **Pan**, and "Level."

For more information, please see "0–9c: Audio Inputs" on page 25.

**0–8a: Input**

**Input 1 & 2**

These are settings for analog inputs 1 & 2.

**Bus Select (IFX/Indiv.)** [L/R, IFX1...12, 1...4, 1/2...3/4, Off]

This specifies the main bus routing for the input signal.

**L/R:** The input signal will be sent to the L/R bus.

**IFX1...12:** The input signal will be sent to the IFX1–12 bus. Choose one of these settings if you want to apply an insert effect while sampling.

**1...4:** The input signal will be sent to the specified INDIVIDUAL OUTPUT in monaural. The **Pan** setting will be ignored.

**1/2...3/4:** The input signal will be sent in stereo (including the effect of the **Pan** control) to the specified INDIVIDUAL OUTPUT pair.

**Off:** The input signal will not be routed directly to the outputs or Insert Effects. However, it may still be routed to an FX Control Bus or REC Bus.

**FX Control Bus** [Off, 1, 2]

This sends the external audio input signal to an FX Control bus (two stereo channels; FX Ctrl 1 and 2). See "FX Control Buses" on page 860.

**REC Bus** [Off, 1...4, 1/2, 3/4]

This sends the external audio input signal to the REC buses (four mono channels; 1...4).

Use the REC buses when you want to sample in various modes or to record audio tracks in Sequencer mode. These are dedicated buses for recording.

You can sample these signals by setting **Source Bus** (0–8c) to REC bus.

Normally you will set **Source Bus** (0–8c) to L/R, and sample the signal from the L/R bus. However, you can use the REC buses when you want to play the keyboard or play back an audio CD while sampling only the audio input. You can also mix several audio input sources to the REC buses, or mix the direct sound of an audio input with sound processed by an insert effect and mix them to the REC buses for sampling. See the diagram "Source Bus = REC Bus 1/2" (0–8c).

**Off:** The external audio signal will not be sent to the REC buses. Normally you will use the Off setting.

**1...4:** The external audio input signal will be sent to the specified REC bus. The **Pan** setting is ignored, and the signal is sent in monaural.

**1/2, 3/4:** The external audio input signal will be sent in stereo to the specified pair of REC buses. The **Pan** setting sends the signal in stereo to buses 1 and 2 or buses 3 and 4.

**Send1 (to MFX1)** [000...127]

**Send2 (to MFX2)** [000...127]

These adjust the levels at which the external audio input signal is sent to the master effects.

**Send1 (to MFX1):** Send the signal to master effect 1.

**Send2 (to MFX2):** Send the signal to master effect 2.

If **Bus Select (IFX/Indiv.)** is set to IFX1–12, the send levels to the master effects are set by the post-IFX1–12 **Send1** and **Send2** (8–5a).

*Tip:* You can use the control surface to control this parameter. (See "Using the control surface with the Audio Inputs" on page 14)

**PLAY/MUTE** [Off, On]

This indicates whether the external audio signal being input is in PLAY or MUTE status.

You can use the MIX PLAY/MUTE 1–6 switches to change this.

**MUTE:** The external audio input signal is muted (silent), and will not be input.

**PLAY:** The external audio input signal is being input according to the settings of the relevant parameters.

*Tip:* You can use the control surface to control this parameter. (See "Using the control surface with the Audio Inputs" on page 14)

**SOLO On/Off**

- This indicates the SOLO status of each external audio signal input. You can use the MIX SELECT 1–6 switches to change this.

Sound will be output only from channels for which SOLO is On. Samples, and multisamples will be muted.

The setting of the **Exclusive Solo** page menu command specifies how the Solo function will operate.

**Exclusive Solo Off:** Selected is off, you can solo multiple audio inputs. The solo status will change each time you press Solo On/Off.

**Exclusive Solo On:** Selected is on, pressing a Solo button will solo only that audio input.

 The SOLO setting is not memorized when you Write.

*Tip:* You can hold down the ENTER switch and press numeric key 1 to switch Exclusive Solo on/off.

*Tip:* You can use the control surface to control this parameter. (See "Using the control surface with the Audio Inputs" on page 14)

**Pan** [L000...C064...R127]

This specifies the panning of the external audio input signal. When inputting a stereo audio source, you will normally set the inputs to L000 and R127 respectively.

*Tip:* You can use the control surface to control this parameter. (See "Using the control surface with the Audio Inputs" on page 14.)

**Level** [0...127]

Specifies the level of the external audio signal that will be input. The default is 127.

For more information on using the inputs and setting levels, please see “Avoiding extraneous noise” on page 16, and “Tips for eliminating distortion when using the analog inputs” on page 17.

*Tip:* You can use the control surface to control this parameter. (See “Using the control surface with the Audio Inputs” on page 14.)

**ADC OVERLOAD !**

If the signal level from AUDIO INPUTS 1 & 2 is too high, the “ADC OVERLOAD !” indication will appear. You’ll need to adjust the MIC/LINE gain select switch, the LEVEL knobs, or the output level of your external audio source.

**USB1 & 2**

These are settings for the USB inputs. They are identical to those described under “Input 1 & 2,” above.

*Note:* Audio input settings for CD audio from a USB CD-R/RW drive are made in “P5: Audio CD.”

**S/P DIF L, S/P DIF R**

These are settings for the S/P DIF inputs. They are identical to those described under “Input 1 & 2,” above.

 When using the S/P DIF input, make sure that the word clocks on all connected digital audio devices are configured correctly. For more information, see “System Clock” on page 756.

---

**0–8b: Recording Level [dB]**

**Recording Level** [-Inf, -72.0...+18.0]

**Level Meter**

**CLIP !**

For more information, please see “0–1c: Recording Level [dB]” on page 682.

---

**0–8c: Sampling Setup**

**Source Bus** [Audio Input1/2, USB 1/2, S/P DIF L/R, L/R, REC1/2...3/4, Indiv.1/2...3/4]

You can sample in stereo from the audio inputs, from the two stereo REC busses, or from the signal at any of the 6 outputs (L/R and Individual 1/2-3/4).

When you sample from an output pair or REC bus, you’ll record all audio sent to the output or bus, including internal Programs or Combis, effects, audio inputs, and HDR audio.

When sampling in stereo, the odd-numbered channel (such as 1 or 3) corresponds to the left channel, and the even-numbered channel (such as 2 or 4) corresponds to the right.

For more information, please see “Source Bus” on page 17.

**Source Direct Solo** [Off, On]

This selects what is heard through the L/R outputs and headphones when Sampling REC is enabled.

**On (checked):** Only the signal of the selected **Source Bus** will be heard. This lets you hear only the sound that will be sampled.

**Off (unchecked):** The signal of the selected **Source Bus** will be merged with the main L/R signal. This is the default.

*Note:* If **Source Bus** is set to L/R, this setting is ignored—since that signal is normally heard at the L/R outputs already!

**Pre Trigger REC** [000...500ms]

If you want a portion of sound immediately before the start of sampling to be included in the recorded sample, set this parameter to specify the length.

When sampling with **Trigger Threshold**, sampling will start when the input signal exceeds the **Level** threshold level. However if the **Level** setting causes a portion of the attack to be lost, you can set the “Pre Trigger REC” parameter to capture the early attack as well.

When sampling with **Trigger Sampling START SW**, it is best to use “Metronome Precount” so that the instrumental performance etc. is sampled in tempo. If the performance is ahead of the tempo, this Pre Trigger REC parameter lets you sample without losing any of it.

 If you increase this setting, you will always be sampling an unneeded portion ahead of the desired sample. Normally you should set this to 000 ms, and specify the minimum required length when necessary.

**Trigger [Sampling START SW, Note On, Threshold]**

Specifies how sampling will be initiated.

**Sampling START SW:** Pressing the SAMPLING REC switch will cause the KRONOS to enter sampling-standby mode, and sampling will begin when you press the SAMPLING START/STOP switch.

**Note On:** Press the SAMPLING REC switch and then press the SAMPLING START/STOP switch to enter sampling-standby mode. Sampling will begin when you play the keyboard.

 Sampling will also begin if a MIDI note-on is received (instead of playing the keyboard).

**Threshold:** Sampling will begin automatically when the input level exceeds the specified **Threshold Level**.

**Using Trigger = Sampling START SW**

1. Press the SAMPLING REC switch to enter sampling-standby mode.
2. Use the “Recording Level [dB]” slider to adjust the sampling level.
3. Sampling will begin when you press the SAMPLING START/STOP switch.  
(If you are using the “Metronome Precount” function, pressing the SAMPLING START/STOP switch will cause sampling to begin after the metronome sounds a count-down. If Metronome Setup “Bus (Output) Select” (0–8d) is set to L/R, the metronome will stop sounding at the moment that sampling begins.)
4. To stop sampling, press the START/STOP switch once again.

Sampling will also stop automatically if it continues to the specified **Sample Time** (0–1d).

If you want to create a new sample by processing an existing sound through effects (Resampling), set **Trigger** to Sampling START SW, and set **Resample** (0–8c) to Auto.

### Using Trigger = Note On

1. Perform steps 1 and 2 described above.
2. Press the SAMPLING START/STOP switch.
3. When you play the keyboard or when a MIDI note-on is received, sampling will start automatically.
4. To stop sampling, perform step 4, above.

### Using Trigger = Threshold

1. Press the SAMPLING REC switch to enter sampling-standby mode.
2. Use the “Recording Level [dB]” slider to adjust the sampling level.

 Be careful of changes in the monitoring volume. (Recording Level [dB] 0–8b)

3. Adjust the Level setting. The red triangles at both sides of the “Recording Level [dB]” level bar display will indicate the Level value.

Normally you will set this to a low a level as possible without allowing sampling to be triggered by noise.

4. Press the SAMPLING START/STOP switch. When the input level exceeds the Level you specified, sampling will begin automatically.
5. To stop sampling, press the START/STOP switch once again.

Alternatively, sampling will end automatically if it continues to the time specified for **Sample Time** (0–1d).

### Metronome Precount [Off, 4, 8, 3, 6]

This specifies whether the metronome will sound a count-down before sampling begins. This can be set only if **Trigger** is set to Sampling START SW.

**Off:** Sampling will begin immediately when you press the SAMPLING START/STOP switch from recording-standby mode.

**4, 8, 3, 6:** When you press the SAMPLING START/STOP switch from recording-standby mode, the metronome will count the specified number of beats at the system tempo, and then sampling will begin. If you set this to 4, sampling will begin on the count of 0 after a pre-count of 4–3–2–1–0.

The output destination and level of the metronome sound are specified by Metronome Setup (0–8d). If **Bus (Output) Select** is set to L/R, the metronome will stop sounding the instant sampling actually begins.

### Resample [Manual, Auto]

Specifies how resampling will occur.

This can be set only if **Trigger** is set to Sampling START SW.

The process of sampling a sample (or samples) is called “resampling.”

You can apply effects to a sample and then resample it, or resample a performance of samples that you play.

**Manual:** This is the normal method. Use this when you want to sample an external input sound. If a sample is already assigned, the sample assigned for playing from the keyboard will be resampled together with the external input sound.

**Auto:** The sample assigned to the index will be resampled automatically. Use this when you want to apply an effect to a sample and resample it.

1. Set **Key** to the keyboard location where the sample you that you want to resample is assigned.

 Sampling will not be possible if you specify a key to which a sample has not been assigned.

2. If you want to apply an insert effect, set the **P8: Routing page Bus Select (8–1b)** parameter to IFX1–12, and select the insert effect you want to use.

If you want to apply a master effect, use the **P8: Routing page (OSC MFX Send) Send1** and **Send2** parameters to adjust the send levels, and use **P9: MFX/TFX** to select the master effect(s) you want to use. If you want to apply a total effect, use **P9: MFX/TFX** to select the total effect you want to use.

3. Set **Source Bus (0–8c)** to L/R.
4. Press the SAMPLING REC switch to enter record-ready mode.

5. When you press the SAMPLING START/STOP switch, the current sample will play back automatically, and the resampling will begin.

If you play the keyboard at this time, the sound you play will be resampled together with the source sample.

6. When the sample assigned to the **Key** has played back for its full length, resampling will end automatically.

Alternatively, you can stop resampling by pressing the SAMPLING START/STOP switch once again.

*Note:* When resampling ends, the **Bus Select (8–1b)** setting will automatically be reset to L/R. At the same time, the “MFX1 On/Off,” “MFX2 On/Off,” “TFX1 On/Off,” and “TFX2 On/Off” (“9–1: Routing”) settings will automatically be turned off. These settings are made automatically so that the effect will not be applied again (i.e., a second time) when you play back the sample that was resampled with the effect. Please be aware of this if you want to resample once again. The parameters of the newly created sample will be automatically set the same as the source sample when played back.

### Key [C-1...G9]

When “Resample” is set to Auto, this specifies the note to which the sample to be resampled is assigned.

This can be set only if **Trigger** is set to Sampling START SW.

For the resampling procedure, see “Resample” Auto.



**Threshold Level** [-63dB...0dB]

When sampling with **Trigger** set to Threshold, this specifies the level at which sampling will begin. This can be set only when **Trigger** is set to Threshold. See step 3 of the **Trigger** Threshold procedure.

---

**0–8d: Metronome Setup**

These parameters apply when Metronome Precount is used. For more information, see “Metronome Precount,” above.

**♩ (Tempo)** [040.00...300.00]

This sets the system tempo, which controls the metronome. You can also set the tempo by using the TEMPO knob or the TAP TEMPO button.

Note that this is the main system tempo, and will affect all other tempo-synchronized functions, such as delays and LFOs.

**Bus (Output) Select** [L, R, 1...4]

This sets the audio output for the metronome sound.

**L/R:** The metronome will be heard in the main stereo outputs (L/Mono and R), the S/P DIF output, and the headphones.

**Indiv.1...4:** The metronome will be heard only in the selected individual output.

**Level** [000...127]

This controls the volume of the metronome sound.

---

**▼ 0–8: Page Menu Commands**

The number before each command shows its ENTER + number-key shortcut. For more information on these shortcuts, see “ENTER + 0-9: shortcuts for menu commands” on page 147.

- 0: **Delete Sample.** For more information, see “Delete Sample” on page 726.
- 1: **Copy Sample.** For more information, see “Copy Sample” on page 727.
- 2: **Rename Sample.** For more information, see “Rename Sample” on page 727.
- 3: **Move Sample.** For more information, see “Move Sample” on page 727.
- 4: **Sample Mono To Stereo.** For more information, see “Sample Mono To Stereo (Change Sample Type)” on page 728.
- 5: **Delete MS.** For more information, see “Delete MS (Delete Multisample)” on page 728.
- 6: **Copy MS.** For more information, see “Copy MS (Copy Multisample)” on page 729.
- 7: **Rename MS.** For more information, see “Rename MS (Rename Multisample)” on page 729.
- 8: **Move MS.** For more information, see “Move MS (Move Multisample)” on page 730.
- 9: **Convert MS To Program.** For more information, see “Convert MS (Multisample) To Program” on page 729.

- 10: **MS Mono To Stereo.** This will appear only if the current MS is Mono. For more information, see “MS Mono To Stereo/MS Stereo To Mono (Change Multisample Type)” on page 730.
- 10: **MS Stereo To Mono.** This will appear only if the current MS is Stereo. For more information, see “MS Mono To Stereo/MS Stereo To Mono (Change Multisample Type)” on page 730.
- 11: **Optimize RAM.** For more information, see “Optimize RAM” on page 148.
- 12: **Select Directory.** This applies only when **Save to** is set to **Disk**. For more information, see “Select Directory” on page 149.
- 13: **Auto Sampling Setup.** For more information, see “Auto Sampling Setup” on page 731.

## 0-9: Control Surface

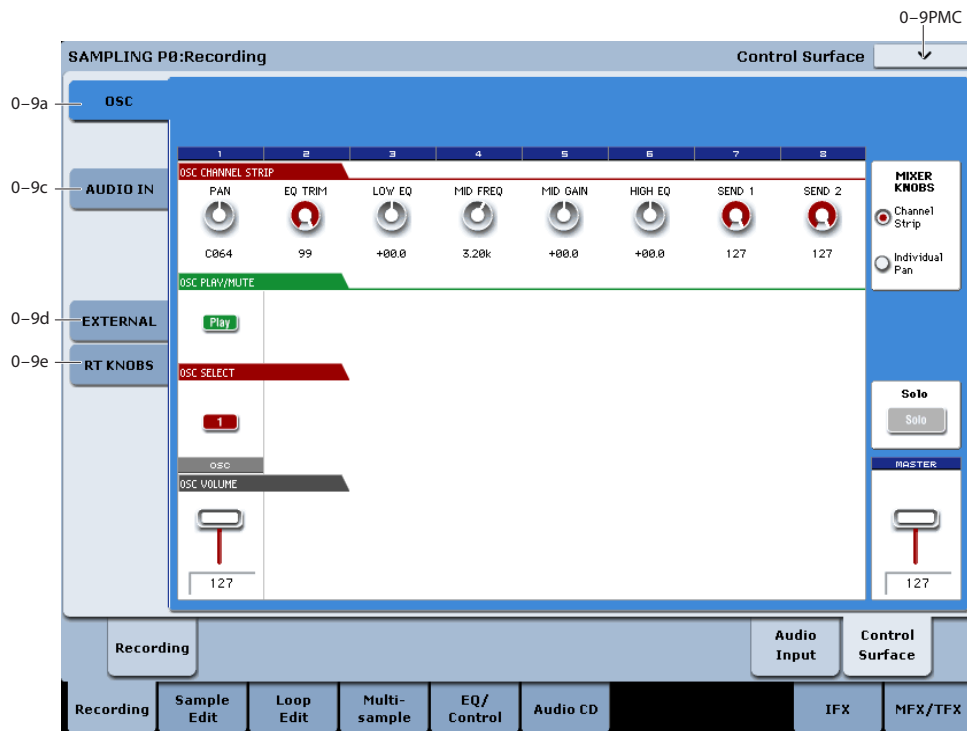

The Control Surface is the set of 9 sliders, 8 knobs, and 16 switches to the left of the LCD display. It looks like a mixer, but it can do other things as well, including editing sounds, controlling KARMA, and sending MIDI messages to external devices.

This page shows you the current values for each of the sliders, knobs, and buttons, along with information about what they are controlling. For instance, you can:

- Adjust the Oscillator's (multisample) volume and pan
- Control the Oscillator's (multisample) EQ settings and Master Effects Send levels
- Modulate Oscillators (multisample) and effects using the Real Time Knobs
- Use the sliders and switches to control external MIDI devices.

### Control Assign Switches and Tabs

You can switch the Control Surface between its different functions using either the tabs on the left side of the LCD display, or the front-panel Control Assign switches. The tabs and the front-panel switches mirror one another; when you change one of them, the other changes as well.

### Control Assign switches

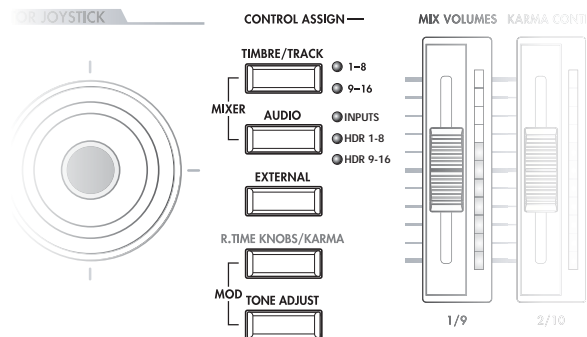

In Sampling mode, you can select one of five different functions:

**TIMBRE/TRACK** lets you adjust the Oscillator's (multisample) volume, pan, and send levels, along with the EQ.

**AUDIO INPUTS** lets you adjust the volume, pan, and send levels for the analog, USB, and S/P DIF audio inputs.

**EXTERNAL** lets you send MIDI messages to external MIDI devices.

**R.TIME KNOBS/KARMA** lets you modulate sounds and effects with the knobs.

For more information about the Control Surface, see:

- "Jump/Catch" on page 22
- "RESET CONTROLS" on page 22



## 0–9a: OSC Mixer

This Control Assign setting lets you adjust the volume, pan, and FX send settings for Oscillators 1 and 2, along with the Program EQ settings.

If you want to save the sound you’ve edited here, you can resample it.

### MIXER KNOBS [Channel Strip, Individual Pan]

The Mixer Knobs switch is on the front panel, immediately to the right of the knobs, and is also duplicated in the on-screen display. The eight knobs can control two different sets of parameters, depending on the setting of this switch.

**Channel Strip:** With this setting, the eight knobs will control the Pan, EQ, and FX Send settings for the selected Oscillator.

**Individual Pan:** With this setting, the first knob will control the Pan for Oscillator 1. The remaining knobs are unused.

*Mixer Knobs switch*

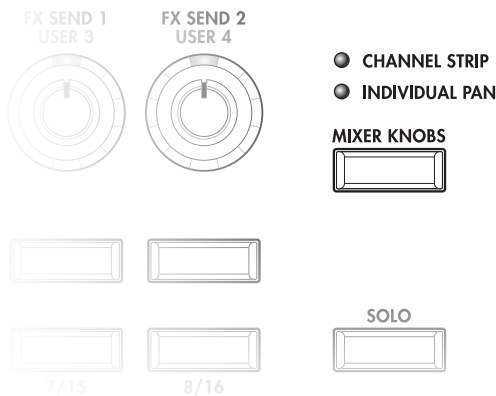

### Knobs 1–8, Channel Strip

When the Mixer Knobs switch is set to Channel Strip, the knobs provide quick access to the Pan, EQ, and FX Send parameters. The Pan and EQ parameters duplicate the similarly-named parameters found on the Program editing pages.

#### PAN [Random, L001...C064...R127]

This controls the stereo pan of the selected Oscillator. A setting of **L001** places the sound at the far left, **C064** in the center, and **R127** to the far right.

**Random** is available only via the LCD. (Otherwise, it would be difficult to use the knob to sweep smoothly from left to right.) With the **Random** setting, the pan position will be different for each note-on.

#### EQ TRIM [00...99]

This controls the volume level going into the EQ.

High settings of the Low, Mid, and High Gain controls can cause substantial increases in the overall level. You can compensate for this by turning down the input trim.

 Note: if the EQ page EQ Bypass parameter is turned On, then none of the EQ parameters here will have any effect.

#### LOW EQ [–18.0...+00.0...+18.0dB]

This controls the gain of the 80Hz Low Shelf EQ, in increments of 0.5dB.

#### MID EQ FREQUENCY [100Hz...10kHz]

This sets the center frequency for the Mid sweep EQ.

#### MID EQ GAIN [–18.0...+00.0...+18.0dB]

This controls the gain of the Mid Sweep EQ, in increments of 0.5dB.

#### HIGH EQ [–18.0...+00.0...+18.0dB]

This controls the gain of the 10kHz High Shelf EQ, in increments of 0.5dB.

#### SEND 1 [000...127]

This controls the send level into FX Send 1. If the Program’s **Output Bus** parameter is set to L/R or OFF, it scales the Oscillator send levels. If the **Output Bus** is set to IFX 1–12, it directly controls the post-IFX send levels.

#### SEND 2 [000...127]

This controls the send level into FX Send 2. For more details, see “SEND 1,” above.

### Knobs 1–2, Individual Pan

When the Mixer Knobs switch is set to Individual Pan, knobs 1 and 2 control the pan settings for Oscillators 1 and 2, respectively. The other 6 knobs have no effect.

These duplicate the Pan parameters of the Oscillators 1 and 2 Amp pages; changing them here will change them in the editing pages, and vice-versa.

#### Pan (1) [Random, L001...C064...R127]

This controls the stereo pan of Oscillator 1. A setting of **L001** places the sound at the far left, **C064** in the center, and **R127** to the far right.

**Random** is available only via the LCD. (Otherwise, it would be difficult to use the knob to sweep smoothly from left to right.) With the **Random** setting, the pan position will be different for each note-on.

#### Pan (2) [Random, L001...C064...R127]

This controls the stereo pan of Oscillator 2. For more details, see “Pan (1),” above.

### MIX PLAY/MUTE 1

The top row of switches allow you to turn Oscillators 1 on and off, which can be convenient when editing sounds.

#### Play/Mute [Off, On]

The oscillator will sound if this switch is on (LED = lit). When the switch is off (LED = off), Oscillator 1 will be muted.

### Solo switch and MIX SELECT switch 1

#### Solo [Off, On]

Solo lets you isolate one or more Oscillators or Audio Inputs, so that you hear them by themselves.

## Sampling mode

---

When Solo is **Off** (LED = Off), the Select switches select the current Oscillator; when Solo is **On** (LED = On or blinking), the Select switches let you solo one or both Oscillators.

When Solo is **On**, and one or more Oscillators or Audio Inputs are soloed, the Solo LED will blink on and off to remind you that solo is in use.

### Clearing all solos

To turn off **Solo** for all Oscillators and Audio Inputs at once:

1. **Press and hold the RESET CONTROLS button.**
2. **While holding RESET CONTROLS, press the SOLO button.**

*Note:* The main Solo button merely changes the functions of the Select/Solo switches. It does not enable or clear the individual solo states.

### Exclusive Solo menu parameter

The menu's **Exclusive Solo** parameter also affects the way that Solo works. When **Exclusive Solo** is **Off** (unchecked), you can solo multiple oscillators and inputs at once.

When **Exclusive Solo** is **On** (checked), only one oscillator or input can be soloed at a time. In this mode, pressing a Solo switch automatically disables any previous solos.

You can also toggle **Exclusive Solo** by holding **ENTER** and pressing **1** on the numeric keypad.

### OSC Select/Solo [Off, On]

This switch either selects or solos Oscillator, depending on the Solo switch. For more details, see "Solo," above.

### MIX VOLUMES sliders 1

This adjusts the overall oscillator output level.

### OSC Volume [000...127]

This adjusts the oscillator volume level.

### Master Volume Slider

### Master Volume [000...127]

This controls the volume of the main stereo outputs, after the Total Effects. It does not affect Individual Outputs 1–4.

*Master Volume*

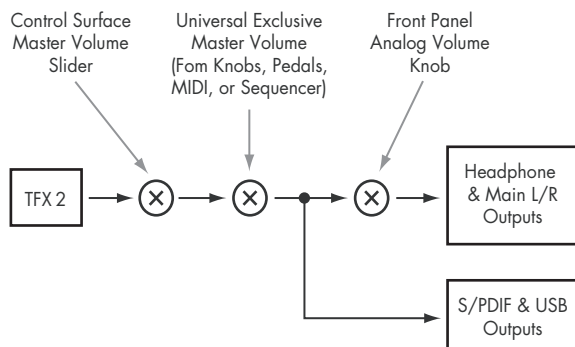

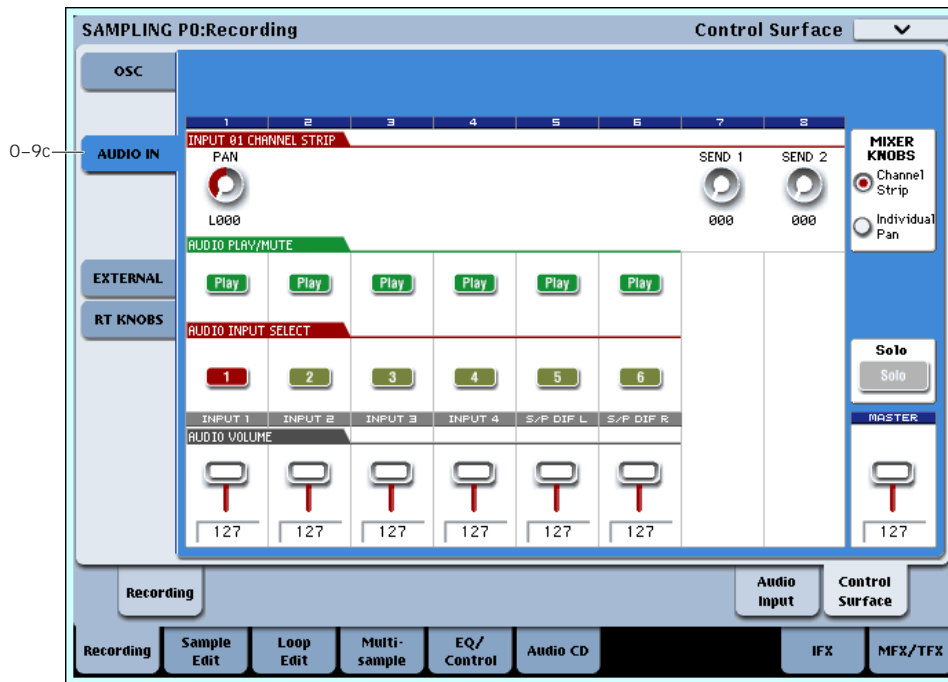

## 0–9c: Audio Inputs

This Control Assign setting lets you adjust the volume, pan, and FX send settings for each of the six audio inputs: Analog 1 & 2, USB 1 & 2, and S/P DIF left and right.

### Mixer Knobs [Channel Strip, Individual Pan]

This switch controls whether the knobs show the pan settings for all 6 inputs at once (Individual Pan), or the pan and FX Send levels for the selected input (Channel Strip). For more information, please see “Mixer Knobs” on page 693.

### Knobs 1–8, Channel Strip

When the Mixer Knobs switch is set to Channel Strip, the knobs provide quick access to the selected input’s Pan and FX Send parameters.

### Pan [L000...C064...R127]

This controls the stereo pan of the selected input. A setting of **L000** places the sound at the far left, **C064** in the center, and **R127** to the far right.

### Send 1 [000...127]

This controls the send level into FX Send 1. If the input’s **Output Bus** parameter is set to L/R or OFF, it scales the programmed send level. If the **Output Bus** is set to IFX 1–12, it directly controls the post-IFX send levels, overwriting any previous setting.

### Send 2 [000...127]

This controls the send level into FX Send 2. For more details, see “Send 1,” above.

### Knobs 1–6, Individual Pan

When the Mixer Knobs switch is set to Individual Pan, knobs 1–2 control the pan settings for analog inputs 1–2, knobs 3–4 control USB inputs 1–2, and knobs 5–6 control S/P DIF left and right.

### Audio Input Pan (1–6) [L000...C064...R127]

These control the pan for Analog 1 & 2, USB 1 & 2, and S/P DIF left and right, respectively. A setting of **L000** places the sound at the far left, **C064** in the center, and **R127** to the far right.

### Play/Mute switches 1–6

The top row of switches allow you to mute any or all of the audio inputs.

### Play/Mute (1–6) [Off, On]

When this switch is on (LED = on), the input will be enabled. When the switch is off (LED = off), the input will be muted.

### Solo switch and Select switches 1–6

#### Solo [Off, On]

Solo lets you isolate one or more Oscillators or Audio Inputs, so that you hear them by themselves. It does this by temporarily muting all non-soloed Oscillators and Audio Inputs.

The Select switches can show and control either which audio input is currently selected, or which inputs are soloed. The main Solo button lets you switch back and forth between the two views.

When Solo is **Off** (LED = Off), the Select switches select the current input; when Solo is **On** (LED = On or blinking), the Select switches let you solo one or more inputs.

When Solo is **On**, and one or more Oscillators or Audio Inputs are soloed, the Solo LED will blink on and off to remind you that solo is in use.

*Note:* The main Solo button merely changes the functions of the Select/Solo switches. It does not enable or clear the individual solo states.

For more information, see “Clearing all solos” on page 692, and “Exclusive Solo menu parameter” on page 692.

**Select/Solo (1–6) [Off, On]**

This switch either selects or solos the input, depending on the Solo switch setting. For more details, see “Solo,” above.

**MIX VOLUMES sliders 1–6**

**Audio Input Volume (1–6) [000...127]**

These sliders adjust the volume levels of the audio inputs.

**Master Volume Slider**

**Master Volume [000...127]**

This controls the volume of the main stereo outputs, after the Total Effects. It does not affect Individual Outputs 1–4. For more information, see the diagram “Master Volume” on page 692.

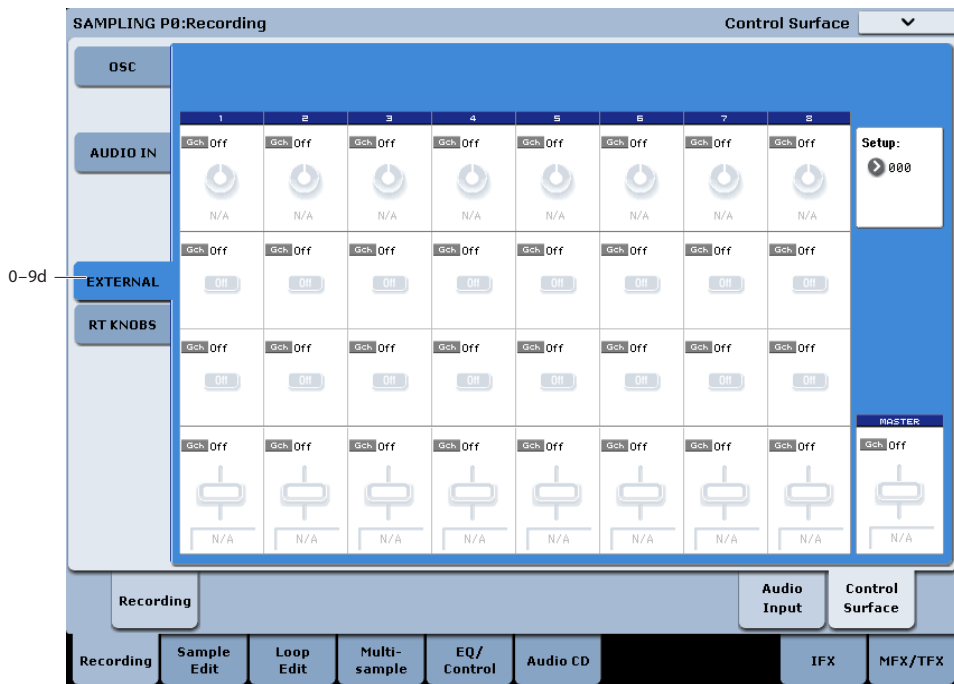

**0–9d: External**

This Control Assign setting lets you send MIDI messages to external devices. Each slider, knob, and switch can be assigned to a separate MIDI controller and MIDI channel. The eight drum pads also have separate settings which apply only when Control Assign is set to External.

In Global mode, you can create up to 128 different External Setups. For instance, you might make one setup for controlling several different pieces of MIDI gear on stage, another for controlling a software synthesizer (such as one of Korg’s Legacy Collection synths), and so on. For more information, see “1–2: External 1” on page 777.

These External Setups are completely separate from the Program. You can think of External mode as being a separate control surface which just happens to share KRONOS’s sliders, knobs, switches, and drum pads.

When you select an External Setup, it stays selected even when you change Programs, or switch to Combi or Sequencer modes. This makes it easy to select different KRONOS sounds without disrupting any external MIDI control, and vice-versa.

**Setup [000...127]**

This selects the Global setup for the knobs, sliders, switches, and drum pads.

*Note:* this selection is not stored with the Program.

**Knobs 1–8**

**MIDI Channel (1–8) [(01...16, Gch)]**

This read-only parameter shows the MIDI Channel assigned to the knob. Each can send on a different channel, if desired.

**Gch** means that the knob will transmit on the Global MIDI Channel, as set in Global mode. This allows you to re-direct any number of sliders, knobs, switches, and pads to a different channel at once, without editing the individual controls.

**CC# Assign (1–8) [(Off, 000...119)]**

This read-only parameter shows the MIDI CC sent by the knob.

**Value (1–8) [000...127]**

This is the current value of the knob’s MIDI CC.

**Switches 1–16**

**MIDI Channel (1–16) [(01...16, Gch)]**

This read-only parameter shows the MIDI Channel for the switch. Each can send on a different channel, if desired.

**Gch** means that the slider will transmit on the Global MIDI Channel, as set in Global mode.

**CC# Assign (1–16) [(Off, 000...119)]**

This read-only parameter shows the MIDI CC sent by the switch.

**Switch On/Off (1–16) [On, Off]**

When the switch is turned on, it sends a value of 127; when it is turned off, it sends a value of 0.

**Sliders 1–8 & Master Slider**

**MIDI Channel (1–8) [(01...16, Gch)]**

This read-only parameter shows the MIDI Channel for the slider. Each can send on a different channel, if desired.

**Gch** means that the slider will transmit on the Global MIDI Channel, as set in Global mode.

**CC# Assign (1–8) [(Off, 000...119)]**

This read-only parameter shows the MIDI CC sent by the slider.

**Value (1–8) [000...127]**

This is the current value of the slider’s MIDI CC.

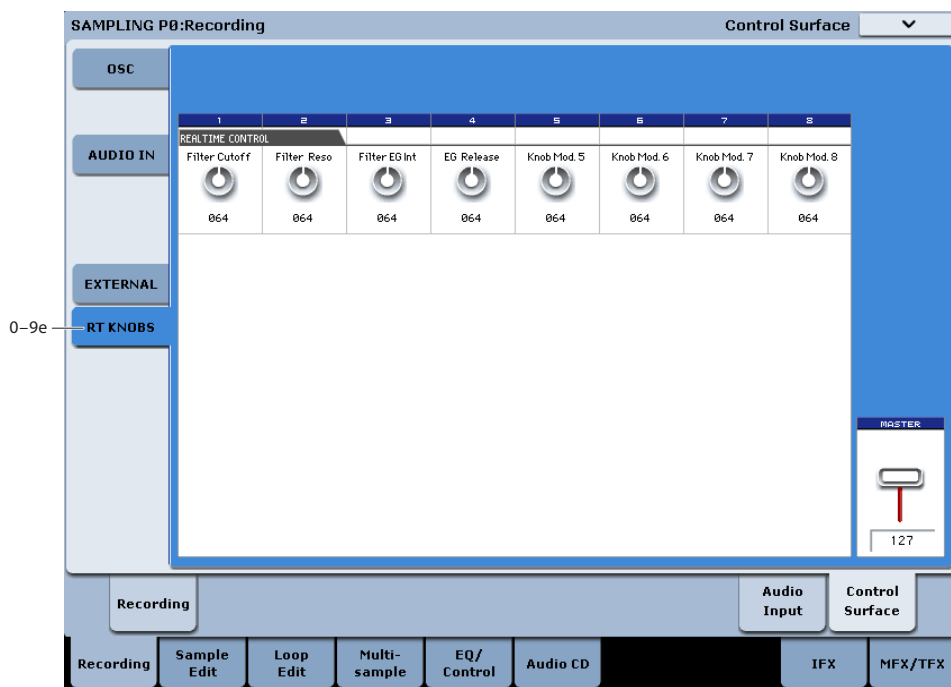

**0–9e: R. Time Knobs** AMSource

This Control Assign setting lets you modulate Oscillators and Effects parameters with the eight knobs.

If you want to save the sound you’ve edited here, you can resample it.

**Knobs 1–8**

Knobs 1–4 all have dedicated functions which correspond to MIDI CCs. Knobs 5–8 can be assigned to a wide variety of functions, many of which also have corresponding MIDI CCs.

When you move a knob, it sends out the corresponding MIDI CC. Also, when the CC is received via MIDI or generated by KARMA, the knob value changes to match the CC value.

Unless otherwise noted, “scaling” means that the parameters are at their programmed values when the controller is at 64, at their minimum when the controller is at 0, and at their maximum when the controller is at 127. For another look at this, see the diagram below.

*CC parameter scaling*

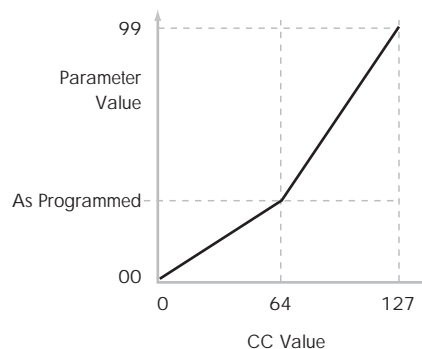

**Knob 1: CUTOFF (CC#74) [000...127]**

This knob scales the cutoff frequencies of Filters A and B, and transmits and receives MIDI CC #74.

**Knob 2: RESONANCE (CC#71) [000...127]**

This knob scales the resonance of Filters A and B, and transmits and receives MIDI CC #71.

### **Knob 3: Filter EG Intensity (CC#79) [000...127]**

This knob scales the effect of the Filter EG on the cutoff frequencies of Filters A and B. It also transmits and receives MIDI CC#79.

### **Knob 4: EG Release (CC#72) [000...127]**

This knob scales the release time of the Filter and Amp EGs, and transmits and receives MIDI CC#72.

### **Knob 5–8 [000...127]**

This is the current value of the knob and its MIDI CC.

You can set knobs 5–8 to a wide variety of modulation functions, using the Controller Setup page (P1–8).

Many of the functions scale a particular set of Program parameters. All of the settings also correspond to MIDI messages—usually CCs.

- 13: **Auto Sampling Setup**. For more information, see “Auto Sampling Setup” on page 731.

---

## ▼ 0–9: Page Menu Commands

The number before each command shows its ENTER + number-key shortcut. For more information on these shortcuts, see “ENTER + 0-9: shortcuts for menu commands” on page 147.

- 0: **Delete Sample**. For more information, see “Delete Sample” on page 726.
- 1: **Copy Sample**. For more information, see “Copy Sample” on page 727.
- 2: **Rename Sample**. For more information, see “Rename Sample” on page 727.
- 3: **Move Sample**. For more information, see “Move Sample” on page 727.
- 4: **Sample Mono To Stereo**. For more information, see “Sample Mono To Stereo (Change Sample Type)” on page 728.
- 5: **Delete MS**. For more information, see “Delete MS (Delete Multisample)” on page 728.
- 6: **Copy MS**. For more information, see “Copy MS (Copy Multisample)” on page 729.
- 7: **Rename MS**. For more information, see “Rename MS (Rename Multisample)” on page 729.
- 8: **Move MS**. For more information, see “Move MS (Move Multisample)” on page 730.
- 9: **Convert MS To Program**. For more information, see “Convert MS (Multisample) To Program” on page 729.
- 10: **MS Mono To Stereo**. This will appear only if the current MS is Mono. For more information, see “MS Mono To Stereo/MS Stereo To Mono (Change Multisample Type)” on page 730.
- 10: **MS Stereo To Mono**. This will appear only if the current MS is Stereo. For more information, see “MS Mono To Stereo/MS Stereo To Mono (Change Multisample Type)” on page 730.
- 11: **Optimize RAM**. For more information, see “Optimize RAM” on page 148.
- 12: **Select Directory**. This applies only when **Save to** is set to **Disk**. For more information, see “Select Directory” on page 149.

## Sampling P1: Sample Edit

In this page you can edit sample data (waveform data). You can make detailed edits while watching the sample waveform display. Here are the main operations you will perform in this page.

- Truncate (delete unwanted regions), copy, paste, move, normalize (boost the level as high as possible without distortion), rate convert (lower the

sampling frequency), reverse (backward playback), and link (connect two samples)

- When performing the above operations, you can automatically detect zero-crossing points, or display a grid (vertical lines) and edit according to BPM values or beats

### 1-1: Sample Edit



#### 1-1a: Multisample Select (MS)

**Multisample Select** [0000...3999]

Selects the multisample that contains the sample you wish to edit.

##### Keyboard & Pads

For more information, please see "0-1a: Multisample Select (MS)" on page 679.

#### 1-1b: Index, Sample Select, Range

**Index** [xxx (001...128)/yyy (001...128)]

Selects the index of the sample you wish to edit. Your editing will affect the sample of the index that you select here, and the waveform will appear in the **Sample waveform display** (0-1a).

*Note:* An index can also be selected by holding down the ENTER switch and playing a note on the keyboard. The index that includes this note will be selected. The key you played will be the base key, and will be displayed in blue in the keyboard graphic.

#### Sample Select

[----: ---No Assign----, 00000...15999]

#### Range

[C-1...B9 - C-1...B9]

This shows the sample number and name for the selected index, and the range. If you modify "Sample Select," the sample you specify here will be assigned to this index (0-1b). The range of the index is shown at the right.

#### 1-1c: Sample waveform display

##### Sample waveform display

This displays the waveform of the selected sample. The horizontal axis is the sample address (time axis), and the vertical axis is the sample level.

In the following diagram, "a" indicates the entire sample. "b" indicates the portion of the entire sample that is shown in "c". As you zoom-in on the time axis, this shows you where the magnified portion lies within the overall sample. You can use the ZOOM buttons to magnify (zoom-in) or shrink (zoom-out) the portion shown in the "c" waveform display.



## Sampling mode

If you have selected a stereo multisample or sample, the L channel and R channel of the sample data will be shown above and below.

### Sample waveform display

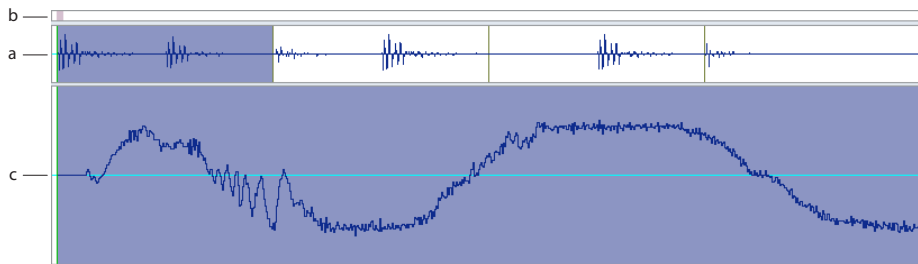

### 1-1d: Edit Range

**Start** [00000000...]

**End** [00000000...]

This specifies the range (start address and end address) of the sample that will be edited by page menu commands. (This is shown in sample address units.)

The range you specify here will be highlighted in the Sample waveform display.

To audition the selected range, press the SAMPLING START/STOP switch or Play button. The sample in the area between **Start** and **End** will sound at the pitch of the currently selected key (displayed in blue) ("Keyboard & Pads" 0-1a).

**Use Zero** [Off, On]

**On (checked):** When setting **Start** and **End**, it will be possible to select these only to locations where the waveform level is  $\pm 0$  (i.e., where the waveform crosses the center line of the **Sample waveform display**). You can use the VALUE slider, VALUE dial, and  $\Delta/\nabla$  switches 0-9 to automatically search for zero-cross addresses. By using the numeric keys you can search for the zero-cross address nearest to the value that you input.

**Off (unchecked):** **Start** and **End** can be set in increments of one. This is the normal setting.

### Edit Range PLAY/STOP

The "Edit Range" will play back when you press the Play button. During playback, this is shown as STOP.

### 1-1e: Grid

**Grid** [Off, On]

**On (checked):** A grid (vertical lines) is superimposed on the sample waveform display. Use "Resolution" and **Tempo** to adjust the grid spacing. Use this setting when you want to cut or edit sample data in units of BPM values or beats.

The starting point of the grid is specified by the Sample Start setting in P2: Loop Edit. If Loop is off, the grid is displayed starting at the **Start** address. If Loop is on, the grid is displayed starting at the **Loop Start** address. The grid indicates the state of the sample when it is played at the currently selected base key (displayed in blue). ("Keyboard & Pads" 0-1a)

**Resolution** [Musical notation]

This specifies the resolution of the grid. The grid is defined by this setting and "Tempo."

**Tempo** [040.00...480.00]

This specifies the spacing of the grid. The grid is defined by this setting and **Resolution**.

You can also set this by using the TAP TEMPO switch.

*Tip:* If you don't know the tempo of the sample, set the tempo by pressing the TAP TEMPO switch several times in rhythm with the playback.

*Note:* 240.00 is the maximum value that you can set using the TAP TEMPO switch.

### 1-1f: ZOOM

#### ZOOM

These buttons let you zoom-in and zoom-out the **Sample waveform display** along the horizontal axis (sample addresses) or vertical axis (sample level).

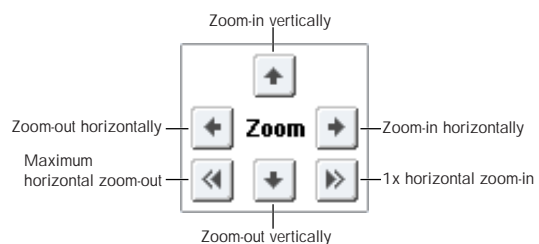

By zooming-in on the horizontal direction, you can move from the overall display where the waveform is shown as a solid line (1X magnification) to 2X or 4X magnification. (With 1X magnification, the display resolution of the LCD will be the same as the resolution of the sample addresses. For example if you change the sample address by one, the vertical line in the LCD that indicates the sample address will move in steps of one pixel.) In the vertical axis, you can zoom-in from 1X (full range display) to 512X (or 1024X in the case of stereo display).

Zoom-In/zoom-out will occur starting at the **Start** or **End** points you specify. (If a different parameter is selected when you zoom-in or -out, the zoom-in/out will be based on the last-selected point. If you re-select the **Start** or **End** points when the display is zoomed in or out, the display range will be adjusted so as to show the selected point.)

 If the zoom ratio is low (1X or less), the **Sample waveform display** may differ slightly from the displayed waveform before and after waveform editing, but this does not affect the playback sound. If this occurs, raising the zoom ratio will make the display accurate.

## ▼ 1–1: Page Menu Commands

The number before each command shows its ENTER + number-key shortcut. For more information on these shortcuts, see “ENTER + 0-9: shortcuts for menu commands” on page 147.

- 0: **Delete Sample**. For more information, see “Delete Sample” on page 726.
- 1: **Copy Sample**. For more information, see “Copy Sample” on page 727.
- 2: **Rename Sample**. For more information, see “Rename Sample” on page 727.
- 3: **Move Sample**. For more information, see “Move Sample” on page 727.
- 4: **Sample Mono To Stereo**. For more information, see “Sample Mono To Stereo (Change Sample Type)” on page 728.
- 5: **Delete MS**. For more information, see “Delete MS (Delete Multisample)” on page 728.
- 6: **Copy MS**. For more information, see “Copy MS (Copy Multisample)” on page 729.
- 7: **Rename MS**. For more information, see “Rename MS (Rename Multisample)” on page 729.
- 8: **Move MS**. For more information, see “Move MS (Move Multisample)” on page 730.
- 9: **Convert MS To Program**. For more information, see “Convert MS (Multisample) To Program” on page 729.
- 10: **MS Mono To Stereo**. This will appear only if the current MS is Mono. For more information, see “MS Mono To Stereo/MS Stereo To Mono (Change Multisample Type)” on page 730.
- 10: **MS Stereo To Mono**. This will appear only if the current MS is Stereo. For more information, see “MS Mono To Stereo/MS Stereo To Mono (Change Multisample Type)” on page 730.
- 11: **Optimize RAM**. For more information, see “Optimize RAM” on page 148.
- 12: **Select Directory**. This applies only when **Save to** is set to **Disk**. For more information, see “Select Directory” on page 149.
- 13: **Auto Sampling Setup**. For more information, see “Auto Sampling Setup” on page 731.
- 14: **Truncate**. For more information, see “Truncate (for Sample Edit)” on page 734.
- 15: **Cut**. For more information, see “Cut” on page 734.
- 16: **Clear**. For more information, see “Clear” on page 734.
- 17: **Copy**. For more information, see “Copy” on page 735.
- 18: **Insert**. For more information, see “Insert” on page 735.
- 19: **Mix**. For more information, see “Mix” on page 735.
- 20: **Paste**. For more information, see “Paste” on page 736.
- 21: **Insert Zero**. For more information, see “Insert Zero” on page 736.
- 22: **Normalize/Level Adjust**. For more information, see “Normalize/Level Adjust” on page 737.
- 23: **Volume Ramp**. For more information, see “Volume Ramp” on page 737.
- 24: **Rate Convert**. For more information, see “Rate Convert” on page 738.
- 25: **Reverse**. For more information, see “Reverse” on page 738.
- 26: **Link**. For more information, see “Link” on page 739.

## Sampling P2: Loop Edit

In this page you can specify the region of the sample that will play and the portion that will loop. You can edit the waveform down to the level of individual samples while watching the sample waveform display. Here are the main operations you will perform in this page.

- Specify the looping locations (start address, loop start address, end address)
- Truncate (delete unwanted regions), copy, paste, move
- When performing the above operations, you can automatically detect zero-crossing points, or display a grid (vertical lines) and edit according to BPM values or beats
- Make settings for reverse (backward) playback
- Use the **Time Slice** or Time Stretch functions to automatically edit the sample according to BPM values or beats

### 2-1: Loop Edit

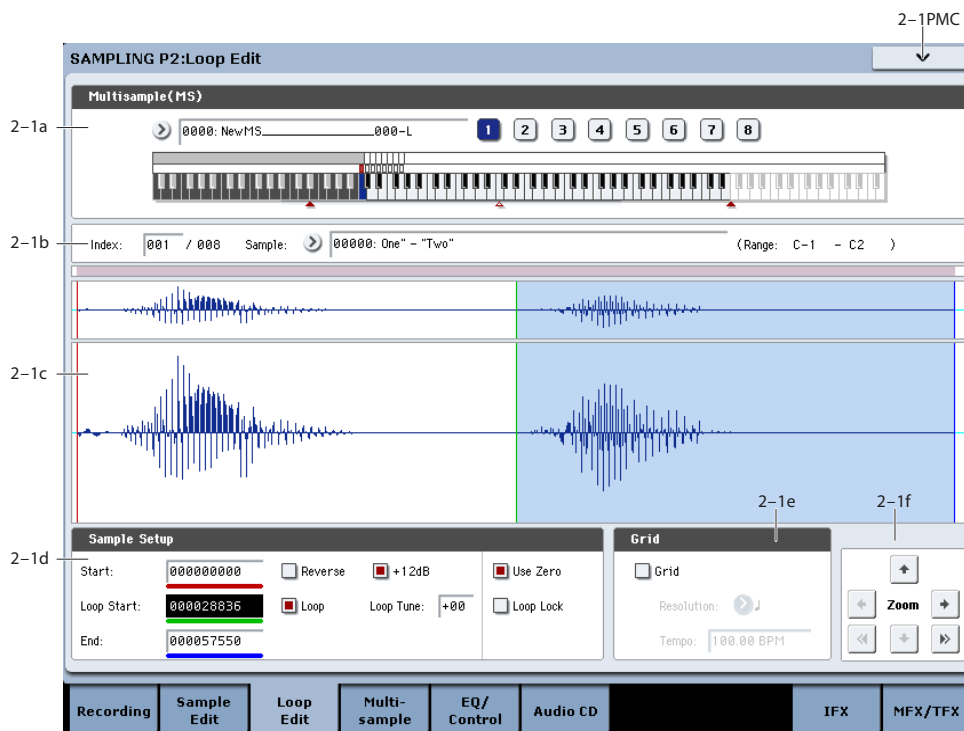

#### 2-1a: Multisample Select (MS)

**Multisample Select** [0000...3999]

Here you can select the multisample to edit.

##### Keyboard & Pads

For more information, please see "0-1a: Multisample Select (MS)" on page 679.

#### 2-1b: Index, Sample Select, Range

**Index** [xxx (001...127)/yyy (001...127)]

Selects the index whose loop and other sample parameters you wish to edit. Your edits will apply to the sample of the index selected here, and the waveform will appear in the **Sample waveform display** (0-1a).

You can also select an index by holding down the ENTER switch and playing a note on the keyboard. The index that includes this note will be selected. The note you played will be the base key, and will be shown in blue in the keyboard graphic.

**Sample Select** [----: ---No Assign---, 00000...15999]

**Range** [C-1...G9 - C-1...G9]

This selects the sample of the index. If you change "Sample Select," the sample you specify will be assigned to this index (0-1b). The sample you select here will appear in the "Sample waveform display."

The range of the index is displayed at the right.

## 2-1c: Sample waveform display

### Sample waveform display

This shows the waveform of the selected Sample. For more information, please see "1-1c: Sample waveform display" on page 697.

## 2-1d: Sample Setup

### Start (Start Address) [00000000...]

This specifies the start point for sample playback, in single-sample units.

### Loop Start (Loop Start Address) [00000000...]

This specifies the loop start point, in single-sample units. This applies only when **Loop** is **On**.

The **Loop Start** must be between the **Start** and **End** points. For more information, see "Start Offset" on page 60.

### End (End Address) [00000000...]

This specifies the end point for sample playback, in single-sample units. When **Loop** is **On**, this is the end point of the loop.

### Loop (Loop On) [Off, On]

Specifies whether or not the sample will be looped.

**On (checked):** When played, the sample will loop repeatedly between the **Loop Start** and **End** points.

For instance, **Start**→**End**→**Loop Start**→**End**→**Loop Start**→...

**Off (unchecked):** The sample will play once from **Start** to **End**, and then stop. This is sometimes called one-shot playback.

If you sample with **Auto Loop On** (0-1d) checked, **Loop** will be enabled automatically.

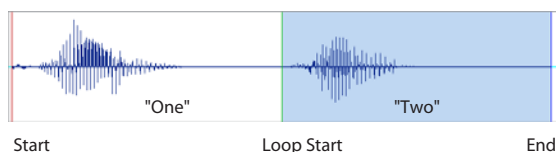

Loop "One" - "Two" - "Two" - "Two" - ...

Loop "One" - "Two"

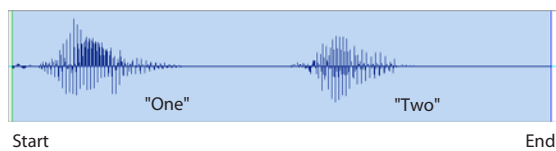

Loop "One" - "Two" - "One" - "Two" - "One" - "Two" - ...

Loop "One" - "Two"

### Reverse [Off, On]

**On (checked):** The sample will be played backward, from the **End** to the **Loop Start**.

### +12dB [Off, On]

On playback, samples are normally reduced in volume by 12dB, to reduce the chance of clipping when playing many voices simultaneously. This parameter lets you defeat the volume reduction for individual samples, when desired.

In general, **+12dB** should be **On** for drums and loops (so that they play at the same level as they were recorded), and **Off** for any sounds that you play polyphonically.

Note that this setting does not change the sample data itself; it only affects the way that the sample is played back.

**On (checked):** The sample playback level will be approximately +12dB louder than if this setting were **Off** (unchecked).

**Off (unchecked):** The sample will play back using the same standard level as the ROM Multisamples and Drum Samples.

You can enable this automatically during sampling by enabling the **Auto +12dB** check-box. For more information, see "Auto +12dB On" on page 683.

This setting is saved in Korg format sample files (.KSF), and is recognized by the OASYS, M3, TRITON Extreme, and TRITON STUDIO. However, it is ignored by older Korg-format-compatible devices. For more information, see "Korg format sample files" on page 1147.

Since it does not affect the sample data itself, this parameter is ignored when exporting to other formats, such as AIFF or WAVE.

**+12dB** is automatically enabled for converted AKAI, AIFF, and WAVE format samples.

### Loop Tune [-99...+99]

When you loop a sample, the pitch of the looped portion may sometimes be slightly different from the sustained portion. Use this parameter to compensate for such cases.

This parameter adjusts the playback pitch of the loop over a range of  $\pm 99$  cents.

### Use Zero [Off, On]

**On (checked):** **Start**, **End** and **Loop Start** can be set these only to locations where the waveform level is  $\pm 0$  (i.e., "zero-cross" addresses where the waveform crosses the center line of the **Sample waveform display**). (1-1d)

**Off (unchecked):** **Start**, **End** and **Loop Start** can be set in steps of one unit. This is the normal setting.

### Loop Lock [Off, On]

This fixes the length of the loop being edited.

**On (checked):** This links the **Loop Start** and **End** points. When one of these points is edited, the other will be adjusted automatically to keep the loop length the same. This is convenient when you are creating a rhythm loop to match a specific tempo.

---

### 2-1e: Grid

**Grid** [Off, On]

**On:** A grid (vertical lines) is superimposed on the sample waveform display. Use **Resolution** and **Tempo** to adjust the grid spacing. For more information, see “1-1e: Grid” on page 698.

**Resolution** 

**Tempo** [040.00...480.00]

---

### 2-1f: ZOOM

#### ZOOM

This allows you to zoom-in/out in horizontal and vertical directions of the **Sample waveform display** (1-1f).

---

## ▼ 2-1: Page Menu Commands

The number before each command shows its ENTER + number-key shortcut. For more information on these shortcuts, see “ENTER + 0-9: shortcuts for menu commands” on page 147.

- 0: **Delete Sample**. For more information, see “Delete Sample” on page 726.
- 1: **Copy Sample**. For more information, see “Copy Sample” on page 727.
- 2: **Rename Sample**. For more information, see “Rename Sample” on page 727.
- 3: **Move Sample**. For more information, see “Move Sample” on page 727.
- 4: **Sample Mono To Stereo**. For more information, see “Sample Mono To Stereo (Change Sample Type)” on page 728.
- 5: **Delete MS**. For more information, see “Delete MS (Delete Multisample)” on page 728.
- 6: **Copy MS**. For more information, see “Copy MS (Copy Multisample)” on page 729.
- 7: **Rename MS**. For more information, see “Rename MS (Rename Multisample)” on page 729.
- 8: **Move MS**. For more information, see “Move MS (Move Multisample)” on page 730.
- 9: **Convert MS To Program**. For more information, see “Convert MS (Multisample) To Program” on page 729.
- 10: **MS Mono To Stereo**. This will appear only if the current MS is Mono. For more information, see “MS Mono To Stereo/MS Stereo To Mono (Change Multisample Type)” on page 730.
- 10: **MS Stereo To Mono**. This will appear only if the current MS is Stereo. For more information, see “MS Mono To Stereo/MS Stereo To Mono (Change Multisample Type)” on page 730.
- 11: **Optimize RAM**. For more information, see “Optimize RAM” on page 148.
- 12: **Select Directory**. This applies only when **Save to** is set to **Disk**. For more information, see “Select Directory” on page 149.

- 13: **Auto Sampling Setup**. For more information, see “Auto Sampling Setup” on page 731.
- 14: **Truncate**. For more information, see “Truncate (for Sample Edit)” on page 734.
- 15: **Time Slice**. For more information, see “Time Slice” on page 740.
- 16: **Time Stretch**. For more information, see “Time Stretch” on page 745.
- 17: **Crossfade Loop**. For more information, see “Crossfade Loop” on page 749.

## Sampling P3: Multisample Edit

In this page you can edit multisamples. You can create, delete, copy, and paste indexes, and assign samples to indexes. You can also edit detailed settings such as level and pitch for each index. Here are the main operations you will perform in this page.

- Create and edit multisamples and indexes
- Edit the playback level and pitch of samples
- Delete, copy, and paste indexes

### 3-1: Multisample Edit

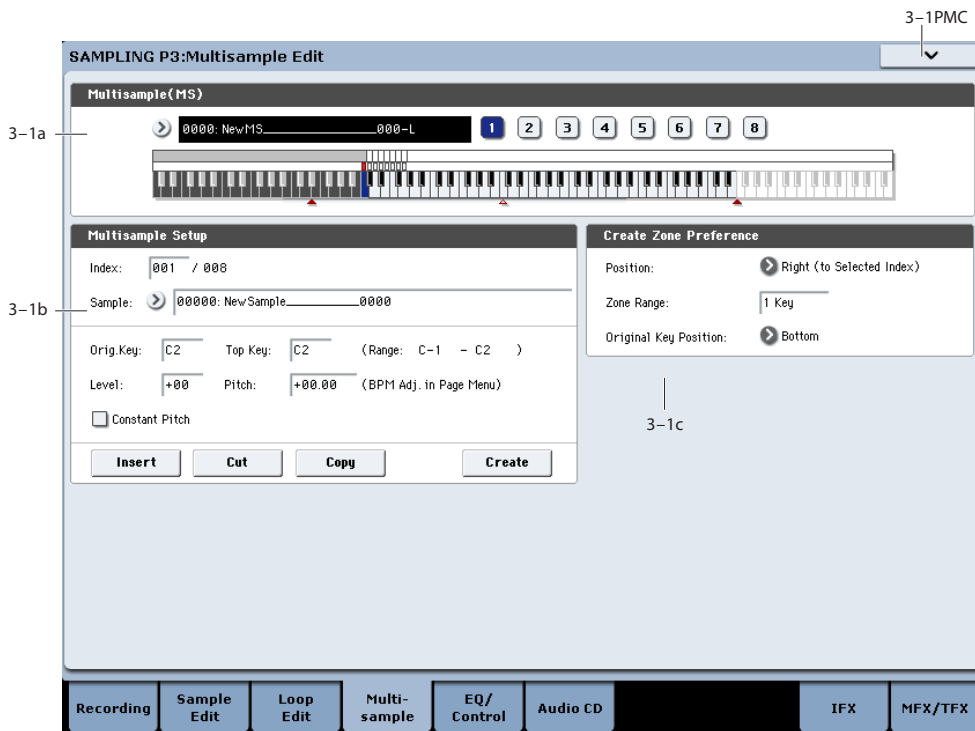

#### 3-1a: Multisample Select (MS)

**Multisample Select (MS)** [0000...3999]

Select the multisample that you wish to edit.

##### Keyboard & Pads

For more information, please see “0-1a: Multisample Select (MS)” on page 679.

#### 3-1b: Multisample Setup

**Index** [xxx (001...128)/yyy (001...128)]

Selects the index (the sample key zone within the Multisample) that you wish to edit.

You can also select an index by holding down the ENTER switch and playing a note on the keyboard. The index that includes this note will be selected. The selected key will be the base key, and will be displayed in blue in “Keyboard & Pads.”

**Sample Select** [----: ---No Assign----, 00000...15999]

This indicates the number and name of the sample that is assigned to the selected index. You can also select the sample here. (0-1b)

##### Stereo

This area will indicate “Stereo” if a stereo multisample or sample is selected, or if you sampled with a setting of Stereo in **Mode** (0-1d).

**Original Key** [C-1...G9]

Specifies the original key of the sample (0-1b).

**Top Key** [C-1...G9]

Specifies the highest key in the zone of the index. The zone is defined by this **Top Key** (0-1b).

**Range** [C-1...G9]

This shows the range of the zone that is determined by the **Top Key** setting. The selected sample data will playback within this area. Zone settings for an index can also be viewed in “Keyboard & Pads” (0-1a).

**Level** [-99...+99]

Adjusts the playback level of the sample. Use this when you need to adjust the level balance between samples within a multisample.

0: Unity level

-: The level will be lowered.

+: The level will be raised.



 Since in Sampling mode the playback unity level will normally be the maximum level, adjustments in the + direction will have no effect. If Volume (CC#07) or Expression (CC#11) has been assigned to the ASSIGNABLE PEDAL or as the Realtime Modulation knob 5–8 and these controllers have been operated, or if these MIDI messages have been received to lower the playback unity level, then adjustments in the + direction will be valid.

*Note:* The playback level will also be affected by the +12dB setting. If +12dB is on, the sample will play back approximately +12dB louder. For more information, see “+12dB” on page 701.

### Pitch (BPM Adj. In Page Menu) [-64.00...+63.00]

Adjusts the playback pitch of the sample in one-cent steps.

0: The sample will sound at the original pitch when the original key is played.

–: The pitch will be lowered. At a setting of –12.00 the pitch will be one octave lower.

+: The pitch will be raised. At a setting of +12.00 the pitch will be one octave higher.

You can also use **Pitch** to make fine adjustments in the length of a rhythm loop. For example with a setting of +12.00, the playback speed will be doubled, and the loop playback time will be 1/2. (Program, Sample Parameters: Pitch)

*Note:* The **Pitch BPM Adjust** page menu command lets you set the playback time in terms of a BPM value.

### Constant Pitch

**On (checked):** All notes in the zone of the index will sound at the pitch of the original key. Use this setting when you have sampled a drum sound or a rhythm loop, and want it to always playback at the original pitch.

**Off (unchecked):** The pitch will change in semitone steps, based on the original key. Use this setting when you have sampled a musical instrument sound etc. and would like to play it conventionally from the keyboard.

### Insert

This creates an index. When you press the Insert button, a new index will be created according to the **Position** setting (0–1e, 3–1c). At this time, the contents of the index that was cut or copied by **Cut** or **Copy** (i.e., the **Zone Range**, **Original Key Position**, **Level** and **Pitch**) will be assigned at the same time. (The sample will automatically be copied or assigned to a different number.)

 If it is not possible to create a new index when you execute **Create** or “Insert,” a dialog box will appear. If this occurs, see **Create** (0–1b).

 If you have not yet executed **Cut** or **Copy**, such as immediately after power-on, the new index will be created according to the Create Zone Preference settings (0–1e, 3–1c) **Position**, **Zone Range**, and **Original Key Position**.

### Cut

This deletes the selected index. At the same time, the contents of the deleted index are copied to the **Insert** buffer.

### Copy

This copies the content of the selected index to the **Insert** buffer.

### Create

This creates an index. When you press the Create button, a new index will be created according to the settings of **Position**, **Zone Range**, and **Original Key Position**. (3–1c, 0–1e) (0–1b).

---

## 3–1c: Create Zone Preference

**Position** [Right (to Selected Index), Left (to Selected Index)]

**Zone Range** [1 Key...127 Keys]

**Original Key Position** [Bottom, Center, Top]

Here you can specify the default settings for indices that are created by executing **Create** (3–1b, 0–1b). New indexes will be created according the settings you specify here. You are free to modify the settings of an index later. Also, when you execute **Insert** (3–1b), the **Position** setting specified here will be used. (Create Zone Preference: 0–1e)

---

## ▼ 3–1: Page Menu Commands

The number before each command shows its ENTER + number-key shortcut. For more information on these shortcuts, see “ENTER + 0–9: shortcuts for menu commands” on page 147.

- 0: **Delete Sample**. For more information, see “Delete Sample” on page 726.
- 1: **Copy Sample**. For more information, see “Copy Sample” on page 727.
- 2: **Rename Sample**. For more information, see “Rename Sample” on page 727.
- 3: **Move Sample**. For more information, see “Move Sample” on page 727.
- 4: **Sample Mono To Stereo**. For more information, see “Sample Mono To Stereo (Change Sample Type)” on page 728.
- 5: **Delete MS**. For more information, see “Delete MS (Delete Multisample)” on page 728.
- 6: **Copy MS**. For more information, see “Copy MS (Copy Multisample)” on page 729.
- 7: **Rename MS**. For more information, see “Rename MS (Rename Multisample)” on page 729.
- 8: **Move MS**. For more information, see “Move MS (Move Multisample)” on page 730.
- 9: **Convert MS To Program**. For more information, see “Convert MS (Multisample) To Program” on page 729.
- 10: **MS Mono To Stereo**. This will appear only if the current MS is Mono. For more information, see



“MS Mono To Stereo/MS Stereo To Mono (Change Multisample Type)” on page 730.

- 10: **MS Stereo To Mono**. This will appear only if the current MS is Stereo. For more information, see “MS Mono To Stereo/MS Stereo To Mono (Change Multisample Type)” on page 730.
- 11: **Optimize RAM**. For more information, see “Optimize RAM” on page 148.
- 12: **Select Directory**. This applies only when **Save to** is set to **Disk**. For more information, see “Select Directory” on page 149.
- 13: **Auto Sampling Setup**. For more information, see “Auto Sampling Setup” on page 731.
- 14: **Pitch BPM Adjust**. For more information, see “Pitch BPM Adjust” on page 750.

## Sampling P4: EQ/Controller

In this page you can edit a mid-sweepable three-band EQ that is applied to the output of the multisample.

You can also assign the functions of the SW1 and SW2 switches and Modulation 5–8 knobs, and the note number and velocity that are produced by pads 1–8.

### 4–1: EQ

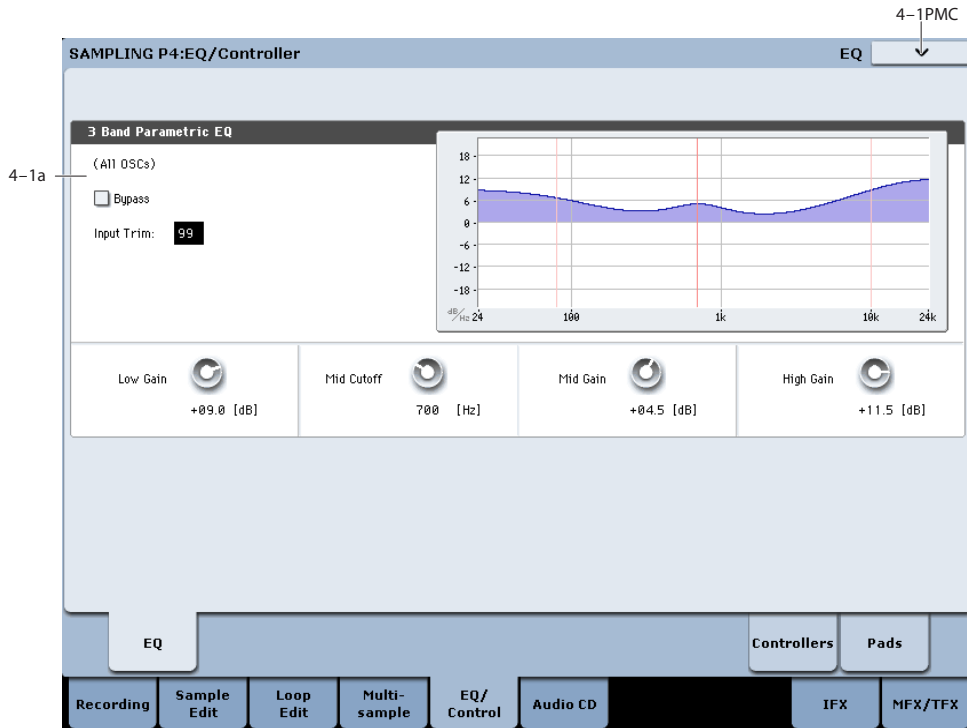

Here you can edit the mid-sweepable three-band EQ that is applied to the output of the multisample.

#### 4–1a: 3 Band Parametric EQ

In addition to editing these parameters in the screen, you can use the control surface to edit all EQ parameters other than “Bypass.” These can also be controlled from the mixer section of the front panel, or from the P0– Control Surface page of the LCD screen. Here’s the procedure for editing these settings from the front panel.

1. Press the CONTROL ASSIGN MIXER TIMBRE/TRACK switch to make 1–8 light.
2. Press the MIXER KNOBS switch to make CHANNEL STRIP light.
3. Use the MIX CHANNEL STRIP knobs 2–6 to control “EQ TRIM,” “LOW EQ,” “MID FREQ,” “MID EQ,” and “HIGH EQ.”

#### (All OSCs)

#### Bypass [Off, On]

When Bypass is checked, all of the EQ will be disabled, including the Input Trim.

Bypass can be convenient for comparing the results of the EQ with the original signal.

#### Input Trim [00...99]

This adjusts the level of the signal going into the EQ. A setting of 50 corresponds to –6 dB, and a setting of 25 corresponds to –12 dB.

High settings of the Low, Mid, and High Gain controls can cause substantial increases in the overall level. You can compensate for this by turning down the input trim.

#### (Freq Response Graphic)

#### Low Gain [–18.0...+00.0...+18.0dB]

This controls the gain of the 80Hz Low Shelf EQ, in increments of 0.5dB.

#### Mid Frequency [100...500 (10Hz step) ... 1.0k (20Hz step) ... 2.0K (50Hz step) ... 10.0k (100Hz step)]

This sets the center frequency for the Mid sweep EQ.

#### Mid Gain [–18.0...+00.0...+18.0dB]

This controls the gain of the Mid Sweep EQ, in increments of 0.5dB.

#### High Gain [–18.0...+00.0...+18.0dB]

This controls the gain of the 10kHz High Shelf EQ, in increments of 0.5dB.

### ▼ 4–1: Page Menu Commands

The number before each command shows its ENTER + number-key shortcut. For more information on these shortcuts, see “ENTER + 0-9: shortcuts for menu commands” on page 147.

- 0: **Delete Sample.** For more information, see “Delete Sample” on page 726.
- 1: **Copy Sample.** For more information, see “Copy Sample” on page 727.
- 2: **Rename Sample.** For more information, see “Rename Sample” on page 727.
- 3: **Move Sample.** For more information, see “Move Sample” on page 727.
- 4: **Sample Mono To Stereo.** For more information, see “Sample Mono To Stereo (Change Sample Type)” on page 728.
- 5: **Delete MS.** For more information, see “Delete MS (Delete Multisample)” on page 728.
- 6: **Copy MS.** For more information, see “Copy MS (Copy Multisample)” on page 729.

- 7: **Rename MS.** For more information, see “Rename MS (Rename Multisample)” on page 729.
- 8: **Move MS.** For more information, see “Move MS (Move Multisample)” on page 730.
- 9: **Convert MS To Program.** For more information, see “Convert MS (Multisample) To Program” on page 729.
- 10: **MS Mono To Stereo.** This will appear only if the current MS is Mono. For more information, see “MS Mono To Stereo/MS Stereo To Mono (Change Multisample Type)” on page 730.
- 10: **MS Stereo To Mono.** This will appear only if the current MS is Stereo. For more information, see “MS Mono To Stereo/MS Stereo To Mono (Change Multisample Type)” on page 730.
- 11: **Optimize RAM.** For more information, see “Optimize RAM” on page 148.
- 12: **Select Directory.** This applies only when **Save to** is set to **Disk**. For more information, see “Select Directory” on page 149.
- 13: **Auto Sampling Setup.** For more information, see “Auto Sampling Setup” on page 731.

## 4–8: Set Up Controllers

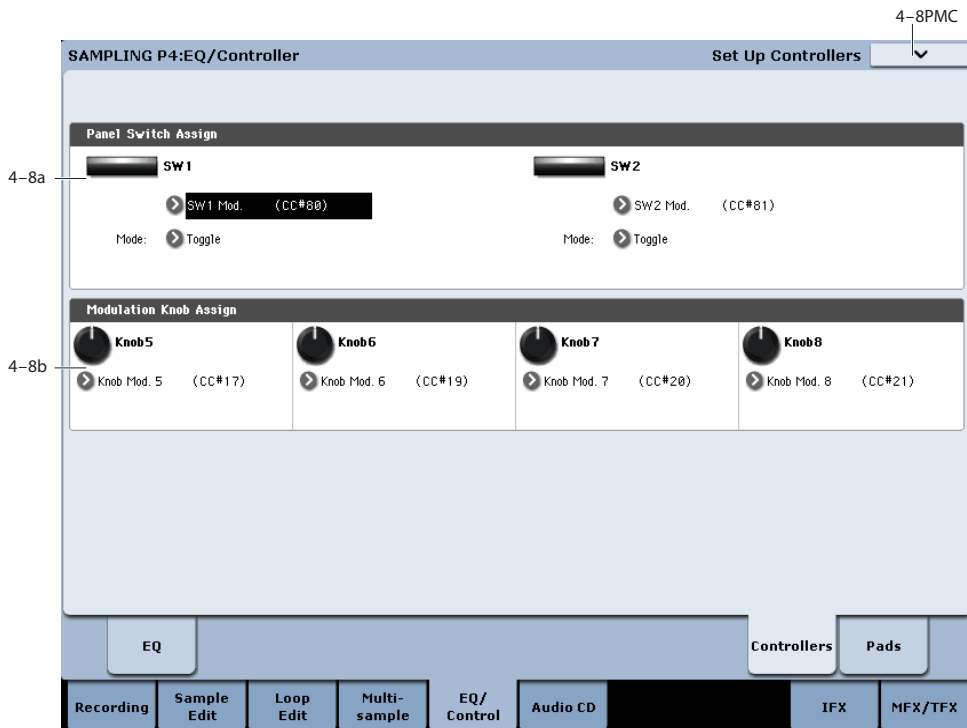

Specifies the functions that the SW1 switch, SW2 switch, and the Realtime Modulation knobs 5–8 will have in Sampling mode.

 In Sampling mode, it is not possible to use AMS to control program parameters.

### 4–8a: Panel Switch Assign

Assigns the functions of the SW1 and SW2 switches. For details on the functions that you can assign, see “SW1/2 Assignments” on page 1104.

#### SW1 [Off, ..., After Touch Lock]

Assigns the function of the SW1 switch. The on/off status is also saved. When you change the assignment, the status is reset to off.

### Mode [Toggle, Momentary]

Specifies how on/off operation will occur when you press the SW1 switch.

**Toggle:** On/off will alternate each time you press the SW1 switch.

**Momentary:** The assigned function will be on only while you hold down the SW1 switch.

### SW2 [Off, ..., After Touch Lock]

#### Mode [Toggle, Momentary]

Assigns the function of the SW2 switch. The functions that can be assigned to SW2 are the same as for SW1 except that SW2 Mod.:CC#81 replaces SW1 Mod.:CC#80. The rest is the same as for the SW1 switch.

---

## 4–8b: Modulation Knob Assign

These settings assign the functions of realtime modulation knobs 5–8. Most of the assignable functions are types of control change. For details, see “Realtime Knobs 5–8 Assignments” on page 1105.

The functions you assign here will be controlled when you operate realtime modulation knobs 5–8.

#### Knob 5 [Off, ..., MIDI CC#119]

#### Knob 6 [Off, ..., MIDI CC#119]

#### Knob 7 [Off, ..., MIDI CC#119]

#### Knob 8 [Off, ..., MIDI CC#119]

These controllers can be used to make realtime changes in effect dynamic modulation functions etc. while you sample.

#### Example: modulating Wet/Dry and post-IFX pan

For example, let’s use realtime modulation knob 5 to control the **Wet/Dry** parameter of a delay assigned to IFX1, and use knob 6 to control the post-IFX “Pan.” Then we’ll sample an audio signal from an external source while controlling these parameters in real-time.

1. Set “Bus Select (IFX/Indiv.)” (0–8a) to IFX1.
2. Select 079: Stereo/Cross Delay for “IFX1.”
3. Set the IFX1 page “Wet/Dry” setting to Dry, “Source” to Knob Mod.5[+], and “Amt” to +50.
4. In the Modulation Knob Assign area, assign “Knob5” to Knob Mod.5 (CC#17) and “Knob6” to Post IFX Pan (CC#08).
5. Rotate knobs 5 and 6 and to change the level and panning of the delay effect. You can sample the sound while modulating the effect.

---

## ▼ 4–8: Page Menu Commands

The number before each command shows its ENTER + number-key shortcut. For more information on these shortcuts, see “ENTER + 0-9: shortcuts for menu commands” on page 147.

- 0: **Delete Sample.** For more information, see “Delete Sample” on page 726.

- 1: **Copy Sample.** For more information, see “Copy Sample” on page 727.
- 2: **Rename Sample.** For more information, see “Rename Sample” on page 727.
- 3: **Move Sample.** For more information, see “Move Sample” on page 727.
- 4: **Sample Mono To Stereo.** For more information, see “Sample Mono To Stereo (Change Sample Type)” on page 728.
- 5: **Delete MS.** For more information, see “Delete MS (Delete Multisample)” on page 728.
- 6: **Copy MS.** For more information, see “Copy MS (Copy Multisample)” on page 729.
- 7: **Rename MS.** For more information, see “Rename MS (Rename Multisample)” on page 729.
- 8: **Move MS.** For more information, see “Move MS (Move Multisample)” on page 730.
- 9: **Convert MS To Program.** For more information, see “Convert MS (Multisample) To Program” on page 729.
- 10: **MS Mono To Stereo.** This will appear only if the current MS is Mono. For more information, see “MS Mono To Stereo/MS Stereo To Mono (Change Multisample Type)” on page 730.
- 10: **MS Stereo To Mono.** This will appear only if the current MS is Stereo. For more information, see “MS Mono To Stereo/MS Stereo To Mono (Change Multisample Type)” on page 730.
- 11: **Optimize RAM.** For more information, see “Optimize RAM” on page 148.
- 12: **Select Directory.** This applies only when **Save to** is set to **Disk**. For more information, see “Select Directory” on page 149.
- 13: **Auto Sampling Setup.** For more information, see “Auto Sampling Setup” on page 731.

## 4-9: Pads

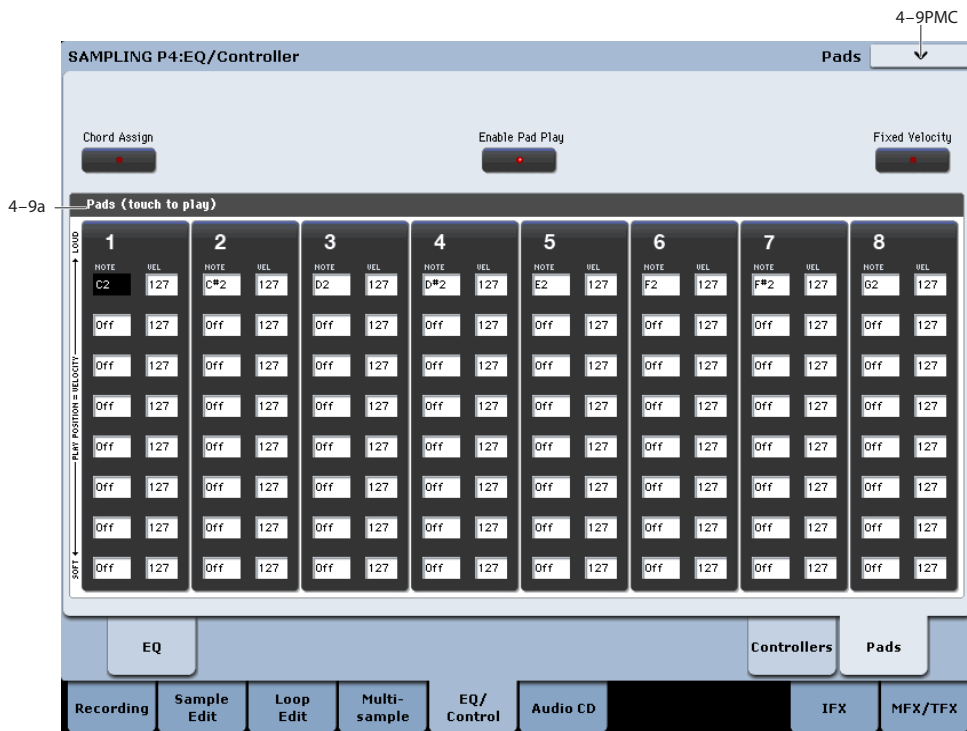

To avoid damaging the display, use care when playing the pads. Do not press strongly on the display or strike forcefully; instead, use a light and precise touch. “Velocity” is controlled by position, and not by force.

This page features 8 virtual “pads,” which can be played by touching the screen, from MIDI input, or from compatible USB MIDI pad devices.

For more information, see “1-9: Pads” on page 54.”

### 4-9a: Pad 1

- 1 [Off, C-1...G9 / 001...127]
- 2 [Off, C-1...G9 / 001...127]
- 3 [Off, C-1...G9 / 001...127]
- 4 [Off, C-1...G9 / 001...127]
- 5 [Off, C-1...G9 / 001...127]
- 6 [Off, C-1...G9 / 001...127]
- 7 [Off, C-1...G9 / 001...127]
- 8 [Off, C-1...G9 / 001...127]

**Off:** Choose this if you don’t want the pad to play a note.

**C-1...G9:** Specify the note number you want to play.

**001...127:** Specify the velocity value.

For details, see “1-9a: Pads” on page 55.”

### Pads 2...8

These are the same as for Pad 1, as described above.

### ▼ 4-9: Page Menu Commands

The number before each command shows its ENTER + number-key shortcut. For more information on these shortcuts, see “ENTER + 0-9: shortcuts for menu commands” on page 147.

- 0: **Delete Sample.** For more information, see “Delete Sample” on page 726.
- 1: **Copy Sample.** For more information, see “Copy Sample” on page 727.
- 2: **Rename Sample.** For more information, see “Rename Sample” on page 727.
- 3: **Move Sample.** For more information, see “Move Sample” on page 727.
- 4: **Sample Mono To Stereo.** For more information, see “Sample Mono To Stereo (Change Sample Type)” on page 728.
- 5: **Delete MS.** For more information, see “Delete MS (Delete Multisample)” on page 728.
- 6: **Copy MS.** For more information, see “Copy MS (Copy Multisample)” on page 729.
- 7: **Rename MS.** For more information, see “Rename MS (Rename Multisample)” on page 729.
- 8: **Move MS.** For more information, see “Move MS (Move Multisample)” on page 730.
- 9: **Convert MS To Program.** For more information, see “Convert MS (Multisample) To Program” on page 729.
- 10: **MS Mono To Stereo.** This will appear only if the current MS is Mono. For more information, see “MS Mono To Stereo/MS Stereo To Mono (Change Multisample Type)” on page 730.

- 10: **MS Stereo To Mono**. This will appear only if the current MS is Stereo. For more information, see “MS Mono To Stereo/MS Stereo To Mono (Change Multisample Type)” on page 730.
- 11: **Optimize RAM**. For more information, see “Optimize RAM” on page 148.
- 12: **Select Directory**. This applies only when **Save to** is set to **Disk**. For more information, see “Select Directory” on page 149.
- 13: **Auto Sampling Setup**. For more information, see “Auto Sampling Setup” on page 731.

## Sampling P5: Audio CD

You can use a USB CD-R/RW drive, to sample directly from an audio CD.

You can even send the live audio from the CD through Insert or Master Effects, to the REC and FX Control Buses, and control pan and level separately for the left and right channels, just as you can with the audio inputs. For more information, see the diagram “Audio input/output” on page 682.

The sampling procedure is essentially the same as when sampling from the audio inputs. Normally, you will set the CD-R/RW Drive Audio Input **Bus Select (IFX/Indiv.)** to L/R (or IFX1-12 if you want to apply an insert effect), and set **Source Bus** to L/R (0-8c).

When ripping, the audio signal from the audio CD is sampled while it’s still in digital form.

Use the **Destination** page menu command to execute ripping. See “Destination (Audio CD Ripping)” on page 750.

- ⚠ Ripping may not be supported by some external CD-R/RW drives, such as drives that do not support reading of CD-DA data. In such cases, you’ll see the message “Error in reading from medium.”

- ⚠ Be aware that if you play the keyboard or controllers while the CD-R/RW drive is operating, the vibration may cause data skips or read errors, making it impossible to play the CD successfully.

### Use the SEQUENCER buttons to play the CD

While you’re on the Audio CD page, you can use the SEQUENCER buttons to control the CD, as described below.

(Seq) START/STOP	Play/Stop
FF>>	Fast-forward
<<REW	Rewind
PAUSE	Pause
LOCATE	Return to the beginning of the track

If the cursor is located at **Range Start** or **Range End**, only the range between the two points will be played back.

## 5-1: Ripping

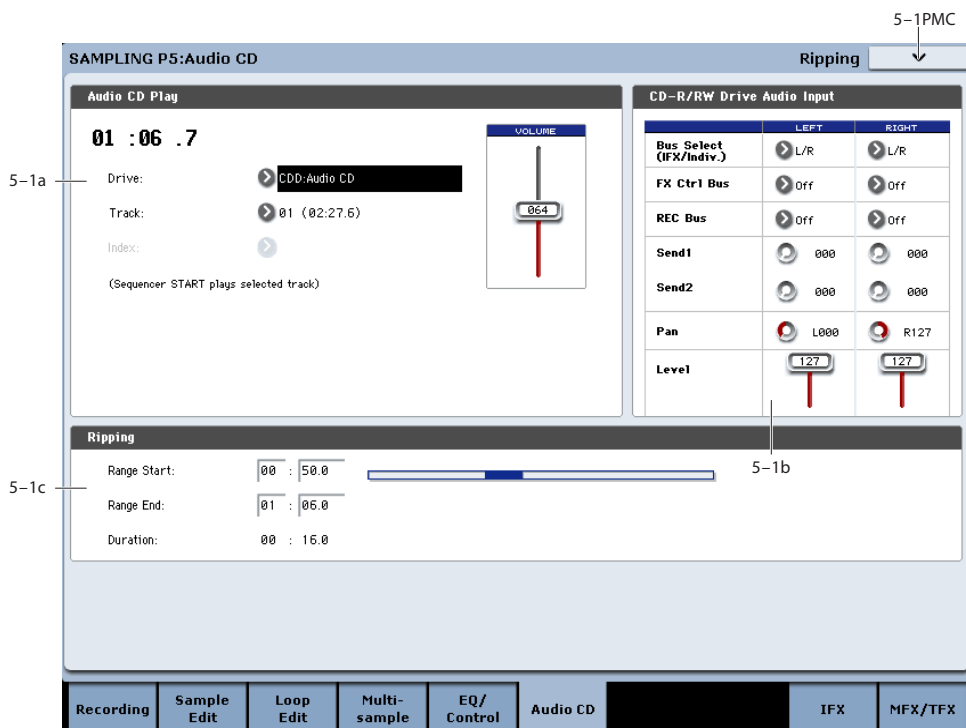

### 5-1a: Audio CD Play

**Location** [(00:00.0...)]

Indicates the current location within the selected **Track**. When stopped, this indicates the location at which playback will begin. If you re-select **Track** or **Index**, the **Location** will be reset to 00:00.0.

### Drive [CDD: Name]

Selects the CD-R/RW drive to use. If you have multiple CD-R/RW drives connected, select the one that contains the audio CD that you want to use.

- ⚠ Drives other than a CD-R/RW drive cannot be selected here.



**Track** [01...]

Selects the track of the audio CD that you want to play or sampling.

**Index** [01...]

Selects the index of the audio CD that you want to play or sampling.

This can be selected only if you have selected a track that contains index data.

In the case of some CD-R/RW drives, index information cannot be obtained.

**Volume** [0...127]

Adjusts the volume of the audio signal that is output from the CD-R/RW drive.

Some CD-R/RW drives do not support this, meaning that this adjustment may not affect the volume.

---

**5-1b: CD-R/RW Drive Audio Input**

This specifies the output destination for the signal from an audio CD played on a connected USB CD-R/RW drive. You can make settings for the L and R channels separately.

*Note:* The CD-R/RW Drive Audio Input settings are linked with the Disk mode "1-2b: CD-R/RW Drive Audio Input" settings.

**LEFT**

**RIGHT**

**Bus Select (IFX/Indiv.)** [L/R, IFX1...12, 1...4, 1/2...3/4, Off]

This specifies the main bus for the CD-R/RW's audio output.

**L/R:** The CD-R/RW's audio will be sent to the L/R bus. This is the default setting, and allows you to hear the CD using the headphone and/or the main outputs.

**IFX1...12:** The CD-R/RW's audio will be sent to the IFX1-12 bus. Choose one of these settings if you want to apply an insert effect.

**1...4:** The CD-R/RW's audio will be sent to the specified INDIVIDUAL OUTPUT in monaural. The **Pan** setting will be ignored.

**1/2...3/4:** The CD-R/RW's audio will be sent in stereo (including the effect of the **Pan** control) to the specified pair of INDIVIDUAL OUTPUTs.

**Off:** The CD-R/RW's audio will not be routed directly to the outputs or Insert Effects. However, it may still be routed to an FX Control Bus or REC Bus.

**FX Ctrl Bus (FX Control Bus)** [Off, 1, 2]

This sends the audio signal from the CD-R/RW drive to the FX Control buses (two stereo channels; FX Ctrl1, 2). For more information, see "FX Control Bus" on page 686.

**REC Bus** [Off, 1...4, 1/2, 3/4]

This sends the audio signal from the CD-R/RW drive to the REC buses (four mono channels 1...4). If you want to use the REC buses for sampling, set **Source Bus** (0-8c) to REC 1/2 or REC 3/4.

The REC buses are used to sample in each mode, and to record audio tracks in Sequencer mode. They are dedicated buses for recording.

**Off:** The audio signal will not be sent to the REC bus. Normally you will use the Off setting.

**1...4:** The audio signal from the CD-R/RW drive will be sent to the corresponding REC bus. The **Pan** setting will be ignored, and the signal will be sent in monaural.

**1/2, 3/4:** The audio signal from the CD-R/RW drive will be sent to the corresponding REC buses. The signal will be sent via the **Pan** setting to buses 1 and 2 or 3 and 4 in stereo.

**Send1 (to MFX1)** [000...127]

**Send2 (to MFX2)** [000...127]

These specify the level at which the audio signal from the CD-R/RW drive is sent to the master effects.

**Send1 (to MFX1):** Send the signal to master effect 1.

**Send2 (to MFX2):** Send the signal to master effect 2.

If **Bus Select (IFX/Indiv.)** is set to IFX1-12, the send levels to the master effects are set by the post-IFX1-12 **Send1** and **Send2** (8-5a).

**Pan** [L000...C064...R127]

This specifies the panning of the audio signal from the CD-R/RW drive. Normally you will set Left and Right to L000 and R127 respectively.

**Level** [000...127]

This specifies the level of the audio signal sent from the CD-R/RW drive. Normally you will set this to 127.

---

**5-1c: Ripping**

Makes settings for ripping data from a CD.

If the cursor is located at **Range Start** or **Range End**, CD playback will occur from **Range Start** to **Range End**.

Ripping is executed in the page menu command **Destination**.

**Range Start** [00:00.0...]

Specify the starting location of the data that will be ripped.

When you re-select **Track** or **Index**, this will be reset to 00:00.0.

*Note:* If the **Range Start** or **Range End** edit cell is highlighted, you can press the ENTER switch during playback to set **Range Start** or **Range End** to the timing location at that moment. If you press the ENTER switch more than once, the location of the last press will be used.

If an edit cell other than **Range Start** or **Range End** is highlighted, pressing the ENTER switch once will specify the "Range Start," and press it once again will specify the **Range End**. If you press the ENTER switch three or more times, the **Range Start** and **Range End** will be set to the locations of the last press and the last-but-one press.

**Range End** [00:00.0...]

Specifies the ending location of the data that will be ripped.

When you re-select **Track** or **Index**, this will be reset to the ending time of the selected track or index.

**Duration** [00:00.0...]

Displays the length of time between **Range Start** and **Range End**.

**Range Graphic**

This graphic shows the selected range within the current Track and Index, as set by the **Range Start** and **Range End** parameters.

---

**▼ 5-1: Page Menu Commands**

The number before each command shows its ENTER + number-key shortcut. For more information on these shortcuts, see “ENTER + 0-9: shortcuts for menu commands” on page 147.

- 0: **Destination**. For more information, see “Destination (Audio CD Ripping)” on page 750.

## Sampling P8: Insert Effect

Here you can make insert effect settings for use in Sampling mode.

If you want to apply an insert effect IFX1–12 to the external audio signal while you sample it, choose IFX1–12 as the **Bus Select (IFX/Indiv.)** (0–8a) parameter for Input1–4 or S/P DIF L,R, and adjust the parameters of the insert effect.

If you want to apply effects to a previously-sampled sample or a sample you loaded, and resample the result, set the P8: Insert Effect page “Bus Select (All OSCs to)” (8–1b) parameter to IFX1–12, and adjust the effect settings. (“Resample” 0–8c)

For instance, you can:

- Send the output of a multisample to an insert effect
- Route a sound to an insert effect

- Make detailed settings for insert effects
- Make common LFO settings for effects

For details on insertion effects, see “Effect Guide” on page 857.

 Insert effect settings for sampling mode will revert to the default settings when the power is turned off.

Use “Copy Insert Effect” if you want to keep your insert effect settings. Select a program or combination, copy the insert effect settings of Sampling mode, and save them. Write the program or combination to save it in internal memory. Then in Sampling mode, use “Copy Insert Effect” to load the effect settings from the program or combination so that they can be used in Sampling mode.

You can also use the “Save to User Preset” menu command to save effects individually.

## 8–1: Routing

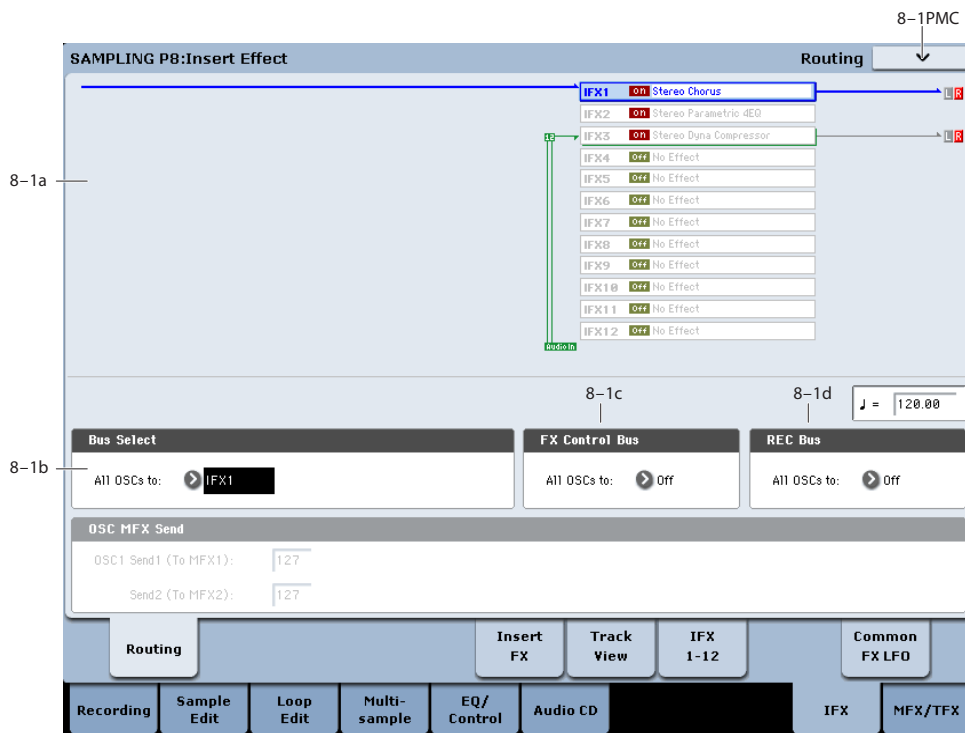

### 8–1a: Routing Map

#### Routing Map

This displays the status of the insert effect settings.

This indicates the input buses being sent to the insert effects, the effects that are assigned, their on/off status, chaining, and the output bus that follows the insert effect.

Use the P8- Insert FX page to select insert effects, turn them on/off, and make chain settings.

### 8–1b: Bus Select

#### Bus Select (IFX/Indiv.Out Assign) (All OSCs to) [L/R, IFX1...12, 1...4, 1/2...3/4, Off]

Selects the bus.

If you want to apply an effect to a sample (multisample) that you sampled or loaded, select IFX1–12. (“Resample” 0–8c)

Note: After you resample, L/R will automatically be selected as the “Bus Select (All OSCs to)” setting. These settings are made automatically so that the effect will not be applied again (i.e., a second time) when you play back the sample that was resampled with the IFX.

(In the same way, the on/off settings for MFX1, 2 and TFX1, 2 will also be turned off.) Be aware of this if you want to sample once again.

---

### 8-1c: FX Control Bus

#### FX Control Bus [Off, 1, 2]

This sends the output of the oscillator (multisample) to a FX Control bus (stereo 2-channel; FX Ctrl1, 2)

Use the FX Control buses when you want to use a separate sound to control the input of an effect. You can use the two (stereo 2-channel) buses to control effects freely.

For more information, please see “FX Control Bus” on page 686.

---

### 8-1d: REC Bus

#### REC Bus (All OSCs to) [Off, 1...4, 1/2, 3/4]

This sends the output of the oscillator (multisample) to the REC buses (four mono channels; 1...4). If you want to resample from the REC buses, set **Source Bus** to REC1/2 or REC3/4.

The REC buses are used to sample in each mode, and to record audio tracks in Sequencer mode. They are dedicated buses for recording.

**Off:** The oscillator output will not be sent to the REC buses. Normally you will leave this Off.

**1...4:** The oscillator output will be sent in monaural to the corresponding REC bus.

**1/2, 3/4:** The oscillator output will be sent in stereo to the corresponding pair of REC buses.

---

### 8-1e: OSC MFX Send

#### Send1 (to MFX1) [000...127]

#### Send2 (to MFX1) [000...127]

This sets the send levels at which the output of the oscillator (multisample) is sent to the master effects. The master effects are sent to the L/R bus. Set the Source Bus to L/R if you want to use master effects while resampling.

**MIDI** You can use CC#93 to control the Send 1 level and CC#91 to control the Send 2 level. The global MIDI channel specified by **MIDI Channel** (Global 1-1a) is used for these messages.

---

### 8-1f: Tempo

#### ♪ (Tempo) [040.00...300.00, EXT]

This is the Global tempo, as used for controlling effects, etc.

---

### ▼ 8-1: Page Menu Commands

The number before each command shows its ENTER + number-key shortcut. For more information on these shortcuts, see “ENTER + 0-9: shortcuts for menu commands” on page 147.

- **0: Copy Insert Effect.** For more information, see “Copy Insert Effect” on page 159.
- **1: Swap Insert Effect.** For more information, see “Swap Insert Effect” on page 159.

For more information, please see “Sampling: Page Menu Commands” on page 726.

## 8-5: Insert FX

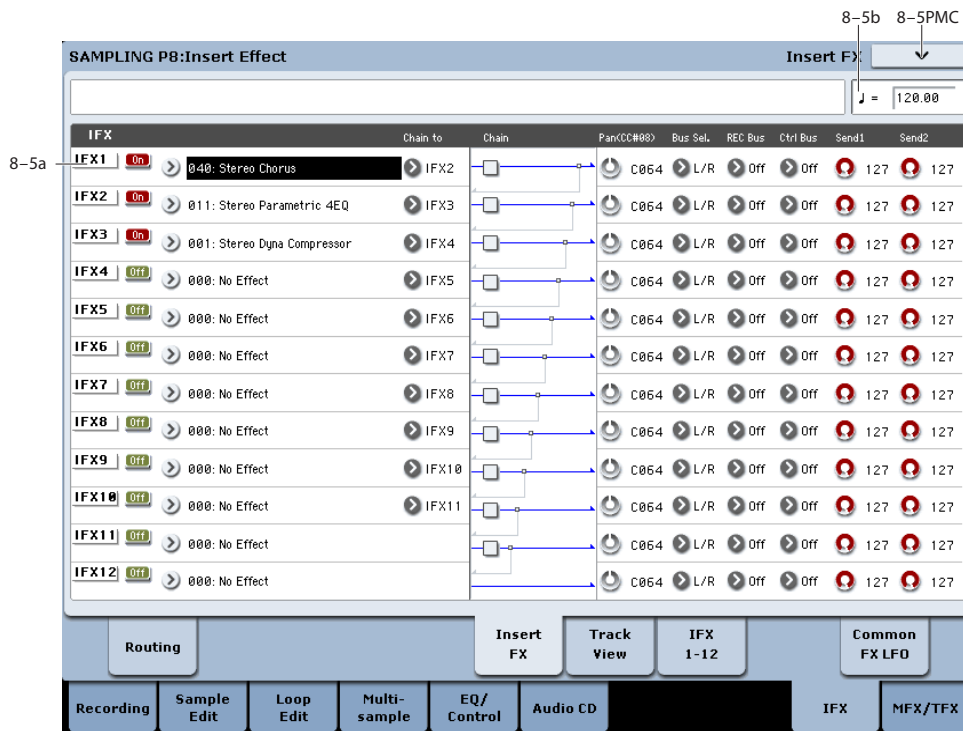

In this page you can select the effect types for the insert effects, turn them on/off, and make chaining settings.

### 8-5a: IFX

Here you can select the type of effect for each insert effect 1-12, turn it on/off, make chaining settings, and make post-IFX mixer settings. For insert effects, the direct (Dry) sound is always stereo-in/out. The configuration of the effect sound (Wet) will depend on the type of effect.

#### IFX1

**IFX1** [000...185]

This selects the effect type for insert effect 1.

#### Category/IFX Select menu

When you press the popup button, the Category/IFX Select menu will appear, letting you select effects by category. Use the tabs to select a category, and then select an effect within that category. Press the OK button to execute your selection, or press the Cancel button to cancel.

**IFX1 On/Off** [Off, On]



Switches the insert effect on/off.

If this is off, the input will simply be passed to the output. (Turning on 000:No Effect is the same as the Off setting.)

The setting will alternate between on and off each time you press this.

**MIDI** Separately from this setting, you can use control change #92 to turn all insert effects off. A value of 0 turns them off, and values of 1-127 restore the original setting. The global MIDI channel specified by **MIDI Channel** is used for this message.

#### Chain to [IFX2...IFX12]

You can chain up to twelve insert effects together in series, to create more complex effects. Set up the chain using this parameter, and then enable it using the **Chain** check box, below.

Effects must be chained in ascending numeric order. For example, IFX1 can be chained to any of IFX2 through IFX12, and IFX2 can be chained to IFX3 through IFX12.

You can chain two or more effects into the same downstream effect. For instance, both IFX1 and IFX2 can be chained to IFX6.

Effects can also join a chain in the middle. For instance, you can chain IFX3 to IFX4 to IFX9, and then chain IFX2 to IFX9 as well.

The **Pan (CC#8)**, **Bus Select**, **REC Bus**, and **Send1/2** settings apply only to the last effect in the chain. However, any effect in the chain can be sent to the FX Control buses.

**Chain** [Off, On]

This enables the chain, as set up by the **Chain to** parameter, above.

**Pan (CC#8) (Post IFX PanCC#8)** [L000...C064...R127]

Specifies the panning immediately after the insert effect.

**MIDI** You can use CC#8 to control this.

**Bus Sel. (Bus Select)** [L/R, 1...4, 1/2...3/4, Off]

Specifies the bus to which the signal will be sent immediately after the insert effect.

**L/R:** The signal will be output to the L/R bus. Then after passing through TFX1 and TFX2, it will be output to AUDIO OUTPUT L/R. This is the normal setting.

**1...4:** The signal will be output in monaural to the selected AUDIO OUTPUT (INDIVIDUAL).

**1/2...3/4:** The signal will be panned by the “Pan (CC#8)” setting and sent in stereo to the selected AUDIO OUTPUT (INDIVIDUAL) pair.

**Off:** The signal will not be sent directly to the L/R or Individual buses. Use this setting if you want to apply **Send1** and **Send2** and then send the signal directly to the master effects.

**FX Control Bus** [Off, 1, 2]

Sends the post-IFX signal to the FX Control buses. See “8-1d: REC Bus” on page 715.

**REC Bus** [Off, 1...4, 1/2, 3/4]

Sends the post-IFX signal to the REC buses. See “8-1d: REC Bus” on page 715. If you want to resample via the REC buses, set **Source Bus** (0-8c) to REC 1/2 or REC 3/4.

**Send1** [000...127]

**Send2** [000...127]

These adjust the level at which the post-IFX signal is sent to master effects 1 and 2. This is valid if **Bus Select** (8-5a) is set to L/R or Off.

**MIDI** You can use CC#93 to control the Send 1 level, and CC#91 to control the Send 2 level. The global MIDI channel specified by **MIDI Channel** is used for these messages.

**IFX2...12**

Here you can specify each insert effect’s effect type, on/off status, chaining, and mixer settings following the insert effect. With the exception of **Chain to** and **Chain**, the parameters are the same as for IFX1. See “IFX1” on page 716.

<b>IFX2: Chain to</b>	[IFX3...IFX12]
<b>IFX3: Chain to</b>	[IFX4...IFX12]
<b>IFX4: Chain to</b>	[IFX5...IFX12]
<b>IFX5: Chain to</b>	[IFX6...IFX12]
<b>IFX6: Chain to</b>	[IFX7...IFX12]
<b>IFX7: Chain to</b>	[IFX8...IFX12]
<b>IFX8: Chain to</b>	[IFX9...IFX12]
<b>IFX9: Chain to</b>	[IFX10...IFX12]
<b>IFX10: Chain to</b>	[IFX11...IFX12]
<b>IFX11: Chain to</b>	[(IFX12)]

These specify the chain destination for each insert effect. If **Chain** (check box) is on, the insert effect will be connected in series to the IFX specified by the **Chain to** setting.

**8-5b: Tempo**

**⌵(Tempo)** [040.00...300.00, EXT]

This specifies the tempo. This setting is used for controlling effects, etc.

**▼ 8-5: Page Menu Commands**

The number before each command shows its ENTER + number-key shortcut. For more information on these shortcuts, see “ENTER + 0-9: shortcuts for menu commands” on page 147.

- 0: **Copy Insert Effect.** For more information, see “Copy Insert Effect” on page 159.
- 1: **Swap Insert Effect.** For more information, see “Swap Insert Effect” on page 159.
- 2: **Insert IFX Slot.** For more information, see “Insert IFX Slot” on page 160.
- 3: **Cut IFX Slot.** For more information, see “Cut IFX Slot” on page 161.
- 4: **Clean Up IFX Routings.** For more information, see “Clean Up IFX Routings” on page 162.

## 8-6: Track View

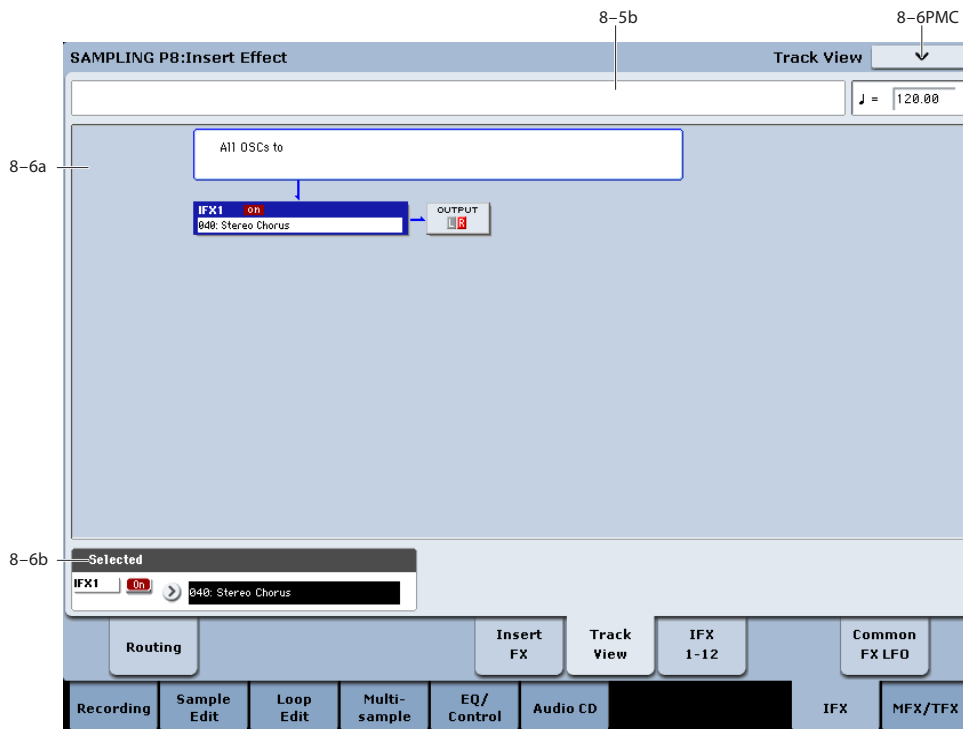

### 8-6a: Track View

This shows the oscillator output and insert effect routing.

The selected slot is shown in dark blue. In the “Selected” area below, you can specify the “Effect Type” and “On/Off” status. The “Insert IFX Slot” and “Cut IFX Slot” page menu commands will apply to the slot you select here.

If you move from this page to the P8-IFX1-12 page, the IFX you choose here will be selected.

### 8-6b: Selected

Here you can specify the “Effect Type” and “On/Off” status of the insert effect slot selected by Track Select. See “8-6a: Track View,” above.

## ▼ 8-6: Page Menu Commands

The number before each command shows its ENTER + number-key shortcut. For more information on these shortcuts, see “ENTER + 0-9: shortcuts for menu commands” on page 147.

- 0: **Copy Insert Effect.** For more information, see “Copy Insert Effect” on page 159.
- 1: **Swap Insert Effect.** For more information, see “Swap Insert Effect” on page 159.
- 2: **Insert IFX Slot.** For more information, see “Insert IFX Slot” on page 160.
- 3: **Cut IFX Slot.** For more information, see “Cut IFX Slot” on page 161.

- 4: **Clean Up IFX Routings.** For more information, see “Clean Up IFX Routings” on page 162.



## 8-7: IFX 1-12

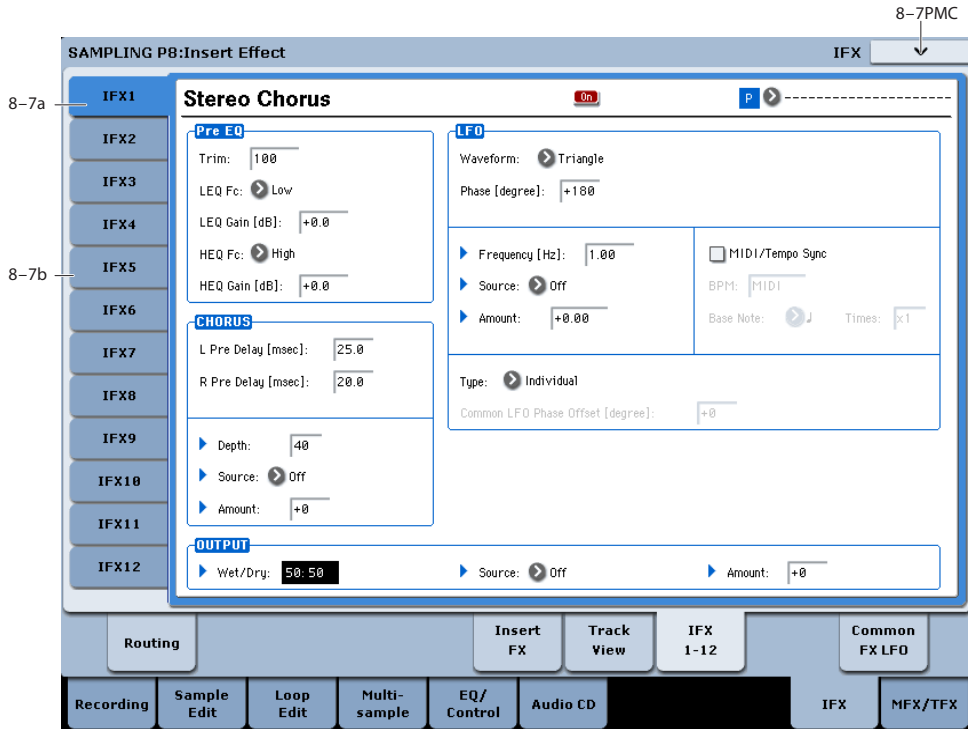

This page lets you edit the detailed parameters of the twelve insert effect s. Use the tabs at left to select IFX1 through IFX12.

To select different effects types, use the Insert FX or Track View pages. For more information, see “8-5: Insert FX” on page 716 and “8-6: Track View” on page 718.

### 8-7a: IFX1

**MIDI** Effect dynamic modulation (Dmod) is controlled on the global MIDI Channel (Global 1-1a).

**IFX1 On/Off** **[Off, On]**



This turns the insert effect on/off. It is linked with the on/off setting in the Insert FX page.

**P (Effect Preset)**  
[P00, P01...15, U00...15, -----]



Effect Presets let you easily store and recall all of the settings for an individual effect. You can store up to 16 user presets for each effect type, in addition to 15 re-writable factory presets.

The same presets appear in all of the modes (Program, Combi, Sequence, and Sampling), and sets of presets can be saved to and loaded from disk.

Note that edits to effects parameters are automatically stored with the Program—you don’t need to store them as an Effect Preset. Presets just make it easier to re-use your favorite settings.

For instance, you can save an Effect Preset while working on a particular Program, and then later use the same Effect Preset in a different Program, Combi, or Song.

**P00: Initial Set:** These are the default settings that are recalled when you select an effect type in the Insert FX page. You can’t save your own settings here.

**P01...P15:** These contain Korg preset data. We recommend that you store your settings in U00-U15.

**U00...U15:** These are areas in which you can store your own settings.

-----: This shows that no Effect Preset has been selected. You’ll see this if you’ve just selected an effect, written a program, or selected a new Program. Selecting this setting from the menu will not have any effect.

**Note:** Programs save the effects parameter settings, but they don’t save the number of the selected Effect Preset. If you select an Effect Preset, and then save the Program, the Effect Preset setting will revert to “-----.”

For more details, see “Using Effect Presets” on page 141.

### IFX1 Parameters

Here you can edit the parameters of the insert effect selected in the Insert FX page.

For details on the insert effects, please see the “Effect Guide,” beginning on page 857.

### 8-7b: IFX2...12

Here you can edit the parameters of the insert effects selected in the P8- Insert FX page.

The parameters for IFX2–IFX12 are the same as for IFX1. See “8–7b: IFX2...12,” above.

### ▼ 8–7: Page Menu Commands

The number before each command shows its ENTER + number-key shortcut. For more information on these shortcuts, see “ENTER + 0-9: shortcuts for menu commands” on page 147.

- **0: Copy Insert Effect.** For more information, see “Copy Insert Effect” on page 159.
- **1: Swap Insert Effect.** For more information, see “Swap Insert Effect” on page 159.
- **2: Write FX Preset.** For more information, see “Write FX Preset” on page 163.

## 8–9: Common FX LFO

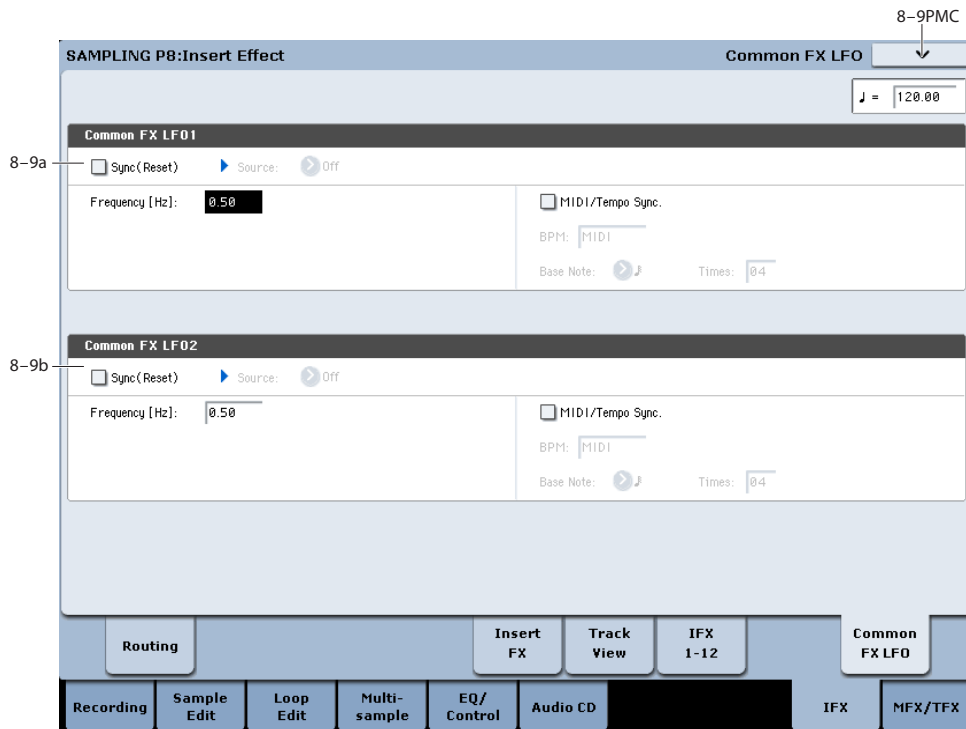

The two Common FX LFOs allow you to synchronize LFO-based modulation for multiple effects, such as phasers, flangers, filters, and so on.

The Common LFOs control only the frequency, MIDI synchronization, and reset options; each individual effect still has its own settings for the LFO waveform and phase.

Within the individual effects, you can choose whether to use one of the Common LFOs, or to use the individual effect’s frequency, sync, and/or reset settings instead. This is done via the effect’s **LFO Type** parameter; select **Individual** to use the effect’s settings, or **Common 1** or **2** to use the Common LFOs.

**MIDI** Dmod (Dynamic Modulation) is controlled on the global MIDI channel specified in Global mode P1.

♩ (**Tempo**) [040.00...300.00, EXT]

This specifies the tempo. This setting is used for controlling effects, etc.

### 8–9a: Common FX LFO1

<b>Frequency</b>	[0.02...20.00 (Hz)]
<b>Sync (Reset)</b>	[Off, On]
<b>Src (Dmod Src)</b>	[List of Dmod Sources]
<b>MIDI/Tempo Sync</b>	[Off, On]
<b>BPM</b>	[MIDI, 040.00...300.00]
<b>Base Note</b>	♩ ... ]
<b>Times</b>	[01...32]

These parameters are the same as in Program mode. See “8–9a: Common FX LFO1” on page 142.

### 8–9b: Common FX LFO2

The parameters are identical to those for Common FX LFO1.

---

## ▼ 8-9: Page Menu Commands

The number before each command shows its ENTER + number-key shortcut. For more information on these shortcuts, see “ENTER + 0-9: shortcuts for menu commands” on page 147.

- **0: Copy Insert Effect.** For more information, see “Copy Insert Effect” on page 159.
- **1: Swap Insert Effect.** For more information, see “Swap Insert Effect” on page 159.

## Sampling P9: Master/Total Effect

Here you can select the effect types for the master effects and total effects, and turn them on/off.

The master effects are output to the L/R bus. The total effects are inserted in the L/R bus. If you want to use these while sampling, set **Source Bus** to L/R.

For more information, please see the “Effect Guide,” beginning on page 857.

*Note:* When you sample, **MFX1 On/Off**, **MFX2 On/Off**, **TFX1 On/Off**, and **TFX2 On/Off** are automatically turned off. This is done so that the effect will not be applied again (i.e., a second time) when you play back the sample that was resampled with the MFX1/2 and TFX1/2. (In the same way, the **Bus Select (All OSCs to)** parameter will automatically be set to L/R.) Be aware of this if you want to sample again.

## 9-1: Routing

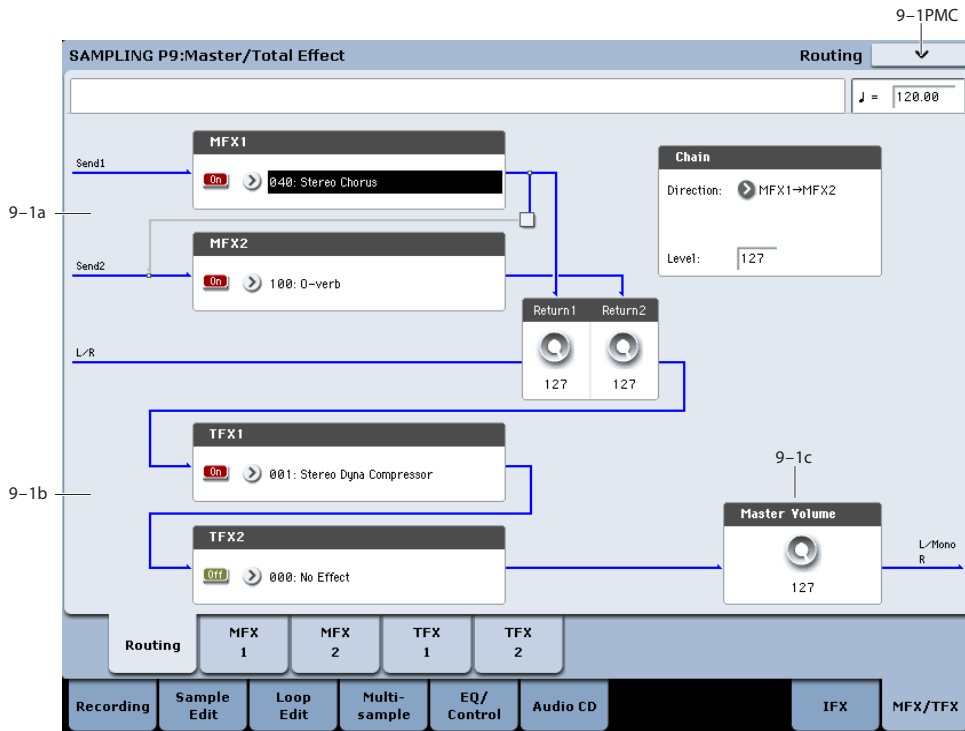

### 9-1a: MFX

The master effect does not output the direct sound (Dry). Adjust the **Return 1** and **Return 2** levels to return the signal to the L/R bus and mix it with the L/R bus signal.

The master effects are stereo-in/out, but depending on the selected effect type, the output may be monaural. See “In/Out” on page 864.

#### MFX1

#### MFX1 [000...185]

This selects the effect type for master effect 1. Choose from 000:No Effect – 185: Mt.BPM Dly // Mt.BPM Dly. If you choose 000:No Effect, the output from the master effect is muted.

#### Category/MFX Select menu

When you press the popup button, the Category/MFX Select menu will appear, letting you select effects by category. Use the tabs to select a category, and then

select an effect within that category. Press the OK button to execute your selection, or press the Cancel button to cancel.

#### MFX1 On/Off

[Off, On]



Switches the master effects 1 on/off. When off, the output will be muted. This will alternate between on and off each time it is pressed.



Separately from the settings here, you can use control change #94 to turn master effects 1 and 2 off. A value of 0 turns them off, and values of 1–127 restore the original setting. The global MIDI channel specified by **MIDI Channel** (Global 1–1a) is used for this message.

#### Return 1

[000...127]

This specifies the return level from the master effect to the L/R bus (after which it passes through TFX1 and 2, and is sent from L/MONO and R).

**MFX2**

**MFX2** [000...185]  
**MFX2 On/Off** [Off, On]  
**Return 2** [000...127]

These parameters specify the effect type for master effect 2, its on/off status, and the return level from master effect 2 to the L/R bus. See “MFX1” on page 722.

**Chain**

**Chain On/Off** [Off, On]  
**On (checked):** Chain (series connection) will be turned on for MFX1 and MFX2.

**Chain Direction** [MFX1->MFX2, MFX2->MFX1]  
 Specifies the direction of the connection when MFX1 and MFX2 are chained.

**MFX1→MFX2:** Connect from MFX1 to MFX2.  
**MFX2→MFX1:** Connect from MFX2 to MFX1.

**Chain Level** [000...127]  
 When chain is On, this sets the level at which the sound is sent from the first master effect to the next master effect.

**9-1b: TFX1, 2**

These are the parameters for total effect 1 and 2, which are placed at the final stage of the L/R bus. After passing through the total effects, the sound is output to AUDIO OUTPUT (MAIN OUT) L/MONO and R.

For the total effects, the direct sound (Dry) is always stereo-in/out. The input/output configuration of the effect sound (Wet) will depend on the selected effect type.

The total effects are stereo-in and stereo-out, but the output may be monaural depending on the type of effect you select.

**TFX1**

**TFX1** [000...185]  
 This selects the effect type for total effect 1. Choose from 000:No Effect – 185: Mt.BPM Dly // Mt.BPM Dly.

**Category/TFX Select menu**

When you press the popup button, the Category/TFX Select menu will appear, letting you choose effect types by category. Use the tabs to select an effect category, and then choose an effect within that category. Press the OK button to execute your choice, or press the Cancel button to cancel.

**TFX1 On/Off** [Off, On]



This turns total effect 1 on/off. If this is off, the input will be passed directly through. The setting will alternate between on/off each time you press this.



Separately from this setting, you can use control change #95 to turn both total effects off. A value of 0 turns them off, and values of 1–127 restore the original setting. The global MIDI channel specified by **MIDI Channel** (Global 1–1a) is used for this message.

**TFX2**

**TFX2** [000...185]  
**TFX2 On/Off** [Off, On]

These parameters specify the effect type and on/off status for total effect 2. See “TFX1,” above.

**9-1c: Master Volume**

**Master Volume** [000...127]

This specifies the final level of the audio output that has passed through total effects 1 and 2, and output from AUDIO OUTPUT (MAIN OUT) L/MONO and R.

*Note:* You can control the master volume from the control surface. You can also control this setting from the P0– Control Surface page.

1. Press the **CONTROL ASSIGN MIXER AUDIO switch to turn it on (lit)**.
2. Use the **MASTER slider to control the level**.

**▼ 9-1: Page Menu Commands**

The number before each command shows its ENTER + number-key shortcut. For more information on these shortcuts, see “ENTER + 0-9: shortcuts for menu commands” on page 147.

- 0: **Copy MFX/TFX**. For more information, see “Copy MFX/TFX” on page 162.
- 1: **Swap MFX/TFX**. For more information, see “Swap MFX/TFX” on page 163.

## 9-2: MFX1

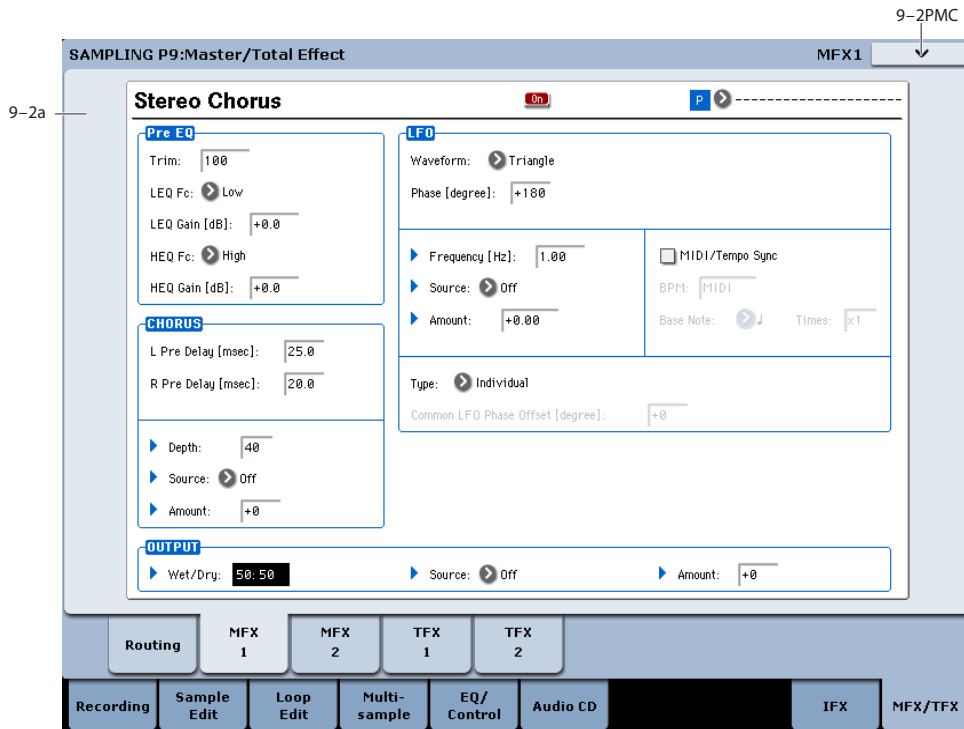

### 9-2a: MFX1

Here you can edit the parameters of the effect you choose for MFX1 in the P9- Routing page.

**MIDI** Effect dynamic modulation (Dmod) is controlled on the global **MIDI Channel** (Global 1-1a).

#### MFX1 On/Off [Off, On]



This turns master effect 1 on/off. It is linked with the on/off setting in the P9: Master/Total Effect - Routing page.

#### P (Effect Preset) [P00, P01...15, U00...15, -----]



This lets you select presets for the current effect. For more information, please see "P (Effect Preset)" on page 719.

#### MFX1 Parameters

Here you can edit the parameters of the master effect selected in the P9-Routing page.

For more details, please see "Master Effects (MFX1, 2)" on page 877.

### ▼ 9-2: Page Menu Commands

The number before each command shows its ENTER + number-key shortcut. For more information on these shortcuts, see "ENTER + 0-9: shortcuts for menu commands" on page 147.

- 0: **Copy MFX/TFX**. For more information, see "Copy MFX/TFX" on page 162.
- 1: **Swap MFX/TFX**. For more information, see "Swap MFX/TFX" on page 163.
- 2: **Write FX Preset**. For more information, see "Write FX Preset" on page 163.

---

## 9-3: MFX2

---

## 9-4: TFX1

---

## 9-5: TFX2

These pages let you edit the parameters of Master Effect 2 and Total Effects 1 and 2. To select different effects types, use the Routing page, as described under “9-1: Routing” on page 722.

The parameters for MFX2, TFX1, and TFX2 are the same as for MFX1. For more information, see “9-2: MFX1” on page 724.



## Sampling: Page Menu Commands

### ENTER + 0-9: shortcuts for menu commands

Each page has a set of menu commands, which provide access to different utilities, commands, and options, depending on the page you're currently on. You can use the menu commands entirely from the touch-screen, by pressing the menu button in the upper right-hand corner of the screen and then selecting an option from the menu that appears.

Even though each page may have its own unique menu commands, the menus are standardized as much as possible. For instance, WRITE is almost always the first menu item in Program, Combination, and Sequence modes.

You can take advantage of this standardization by using a shortcut to access any of the first ten menu items:

1. Hold down the ENTER key.
2. Press a number (0-9) on the numeric keypad to select the desired menu command, starting with 0.

For instance, press 0 for the first menu command, 1 for the second, and so on.

If the menu command just toggles an option on and off (such as Exclusive Solo), then you're done. If the command calls up a dialog box, the dialog will appear on the LCD, and you can proceed just as if you'd selected the command from the touch-screen.

### Remarks on editing stereo samples

- For stereo samples, the L channel and R channel samples are edited simultaneously. If you wish to edit only the L channel or R channel, select a mono multisample, and select either the L channel or R channel sample for editing.
- For stereo samples, the display will indicate "Save to No.(L)" and "(R)." These respectively specify the writing-destination sample numbers for the L and R channels.
- If you Copy a mono sample into the buffer, and then Insert, Mix, or Paste it to a stereo sample, the data will be inserted, mixed, or pasted into both the L and R sides. (The result is that a stereo sample will be created.)

If you Copy a stereo sample into the buffer, and then Insert, Mix, or Paste it to a mono sample, the L- and R-side data in the buffer will be mixed to mono, and then inserted, mixed, or pasted. (The result is that a mono sample will be created.)

You can also use these commands if you wish to mono-mix a stereo sample and use it as a mono sample. However, be aware that once a sample has been mixed to mono, it is no longer possible to return it to a stereo sample.

### Start and End settings

When using the P1: Sample Edit parameters Truncate – "Volume Ramp" and the P2: Loop Edit parameter Truncate to edit the waveform data of a sample, you must first use Start and End to specify the region that you want to edit, and then select and execute a page menu command.

- ⚡ There is no compare function that lets you return the edited result to the state before editing. If you wish to preserve the unedited sample, uncheck the **Overwrite**\*1 item in the dialog box of each page menu command before you execute.

*Note:* To edit the **Start**, **Loop Start**, or **End** points, use P2: Loop Edit.

If the above parameters are located within an area of sample addresses that are deleted or moved by your editing, they will automatically be moved.

- ⚡ The **Loop Start** and **End** (2–1d) must be at least eight samples apart. If you try to use the **Truncate**, **Cut**, or **Rate Convert** commands, but the results of the commands would cause the **Loop Start** and **End** to be separated by less than eight samples, you'll see the error message "Sample length is shorter than minimum." Please set the **Start** and **End** appropriately.

### About Overwrite

When **Overwrite** is **unchecked**: When the command is executed, the edited sample will be saved in a different sample number. The unedited sample will remain without change.

When **Overwrite** is **checked**: When the command is executed, the edited sample will be overwritten onto the original sample (number). The original sample will be modified.

*Note:* Normally, you will leave "Save to No." at its default setting, and execute without checking **Overwrite**. When you execute, both the data before and after editing will be preserved, and the sample number of the edited data will be assigned as the sample of that index.

## Delete Sample

This command deletes all samples, the currently selected sample, or unused samples (samples not mapped to a multisample).

1. Select "Delete Sample" to open the dialog box.

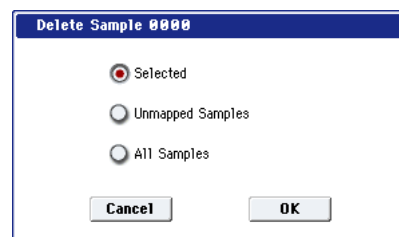

2. Use the radio buttons to specify which samples will be deleted.

**Selected:** The currently selected sample will be deleted. The sample assignment for **Index** (0–1b) will change to ---No Assign---.

**Unmapped Samples:** All samples that are not mapped (used) in a multisample or drum kit will be deleted.

**All Samples:** All samples in memory will be deleted. The sample assignments of all multisamples will change to ---No Assign---

3. To execute the Delete Sample command, press the OK button. To cancel, press the Cancel button.

 If the sample data (waveform data) of the sample you delete is being used by another sample, the sample data itself will not be deleted. Only the sample will be deleted.

## Copy Sample

This command copies the currently selected sample to another sample.

*Note:* The copy destination sample number will automatically be included in the resulting sample name. If necessary, use the **Rename Sample** menu command to rename it. When doing so, make sure that the name is not identical to any other sample name. For more information, please see "About stereo multisamples and stereo samples" on page 681.

1. Use Sample Select (0–1b) to select the copy-source sample.
2. Select Copy Sample to open the dialog box.

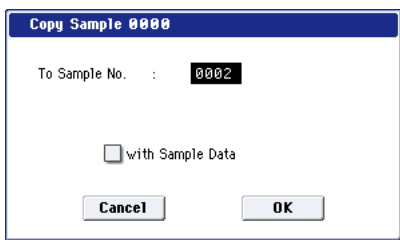

3. Specify the sample number of the copy destination.

**[Stereo]** When copying a stereo sample, specify both the L and R channels for the copy destination sample number.

4. If you check "with Sample Data": Executing the copy will simultaneously copy the sample data (waveform data) as well.

The copy source and copy destination samples will exist as completely independent samples. For example, you would use this when you wish to start with the same sample data, and edit it separately in P1: Sample Edit to create two or more different types of sample.

If you do **not** check "with Sample Data": Executing the copy will not copy the sample data (waveform data). The newly created sample will share the sample data of the copy source sample. For example, you would use this when you wish to use P2: Loop Edit to create two or more versions of the same sample data with different loop addresses. Sample memory area will not be consumed by this type of copy. If you use P1: Sample Edit to edit the sample data, the results will affect all samples that share this sample data.

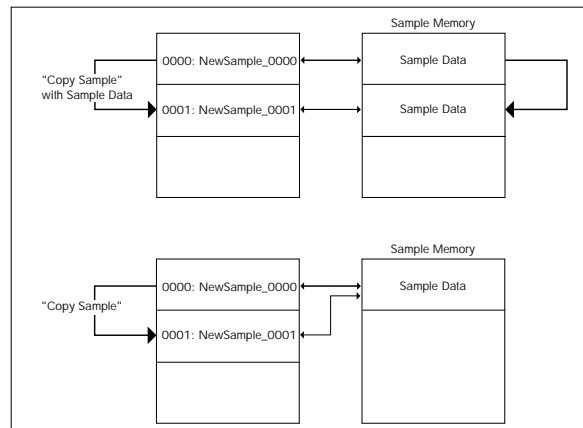

5. To execute the Copy Sample command, press the OK button. To cancel, press the Cancel button.

## Rename Sample

This command lets you modify the name of the currently selected sample.

1. Use Sample Select (0–1b) to select the sample whose name you want to edit.
2. Select Rename Sample to open the dialog box.

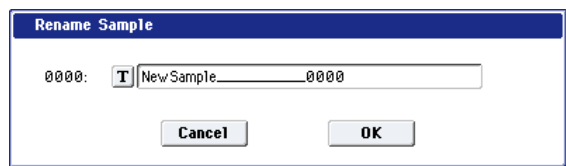

3. Press the text edit button to open the text edit dialog box, and input the desired sample name (up to 24 characters).

**[Stereo]** If the multisample is stereo and a stereo sample is selected, you can input up to 22 characters for the sample name. This is because the last two characters are reserved for -L and -R. If you rename up to 22 characters of the sample of either the L or the R channel, the other sample will automatically be renamed.

4. To execute the Rename Sample command, press the OK button. To cancel, press the Cancel button.

## Move Sample

This command lets you move the currently selected sample to the specified number (i.e., to change the sample number), or to rearrange the sample numbers so that they start from 00000 after samples have become discontinuous as a result of creating or editing. (See diagram below)

When you reassign the sample numbers, the sample numbers within the multisamples and drum kits (according to the setting of step 4) that use these sample will also be automatically reassigned. (This means that the samples of the multisamples and drum kits need not be reassigned following this operation.)

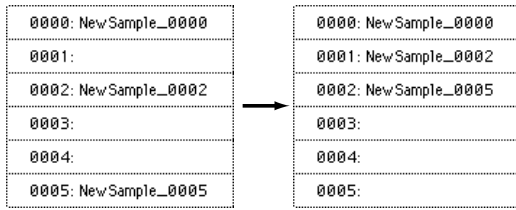

1. Use **Sample Select (0-1b)** to select the copy source sample.
2. Select **“Move Sample”** to open the dialog box.

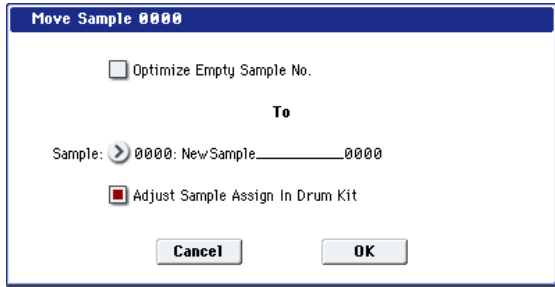

3. Use **To Sample** to specify the move destination sample number.

**[Stereo]** When moving a stereo sample, you must move the samples individually.

If you wish to reassign (pack) all sample numbers starting at 0000, check **Optimize Empty Sample No.**

4. If **“Adjust Sample Assign in Drum Kit”** is checked, and if the samples being moved are mapped to (used by) a drum kit, those sample numbers will also be automatically modified. Normally you will leave this checked.

Samples mapped to (used by) multisamples will be automatically changed to the new sample numbers regardless of this setting.

5. To execute the **Move Sample** operation, press the **OK** button. To cancel without executing, press the **Cancel** button.

**Example)** If data already exists at the move destination sample number, the sample will not be overwritten; instead, all subsequent samples will be renumbered upward.

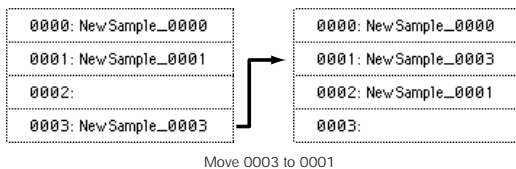

**Example)** If there is no empty sample number and forward movement is not possible, samples will be renumbered downward.

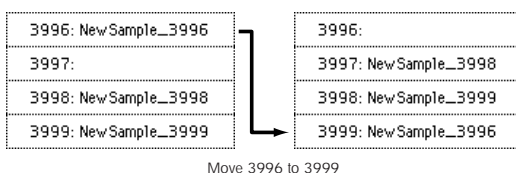

## Sample Mono To Stereo (Change Sample Type)

This command converts a mono sample to stereo. This can be executed when a mono sample is selected.

1. Use **Sample Select (0-1b)** to select the sample that you want to change to stereo.
2. Select **Sample Mono To Stereo** to open the dialog box.

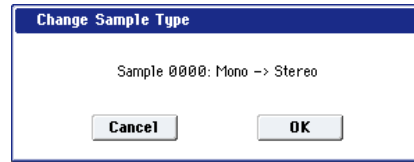

3. To execute the **Change Sample Type** command, press the **OK** button. To cancel, press the **Cancel** button.

When you execute this command, the sample type will change as follows.

- The selected sample will be changed to stereo. The last two characters of the sample name will be overwritten as **“-L”**.
- A new sample will be created with the same name except that the last two characters of the sample name will be **“-R”**. Also, if the selected multisample is mono, it will change to stereo.
- The last two characters of the multisample name will be overwritten as **“-L”**.
- A new multisample will be created with the same name, but whose last two characters are **“-R”**.
- The stereo sample that was created will be assigned automatically.

## Delete MS (Delete Multisample)

This command deletes the currently selected multisample or all multisamples.

1. Use **Multisample Select (MS) (0-1a)** to select the multisample that you want to delete.
2. Select **“Delete MS”** to open the dialog box.

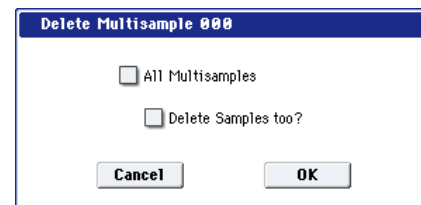

3. **All Multisamples:** Check this if you wish to delete all multisamples.
4. **Delete Samples too?:** Check this if you also wish to delete the samples included in the deleted multisample(s).

However, samples that are mapped to (used by) other multisamples or drum kits will not be deleted.

- To execute the Delete Multisample command, press the OK button. To cancel, press the Cancel button.

 Even if you also choose to delete the samples that are included in the deleted multisample(s), any sample data (waveform data) used by these samples that is shared with other samples will not be deleted. Only the sample itself will be deleted.

### Copy MS (Copy Multisample)

This command copies the selected multisample to another multisample.

*Note:* The copy destination multisample number will automatically be included in the resulting multisample name. If necessary, use the **Rename MS** menu command to rename it. When doing so, make sure that the name is not identical to any other multisample name. For more information, please see "About stereo multisamples and stereo samples" on page 681.

- Use Multisample Select (MS) (0-1a) to select the copy-source multisample.
- Select Copy MS to open the dialog box.

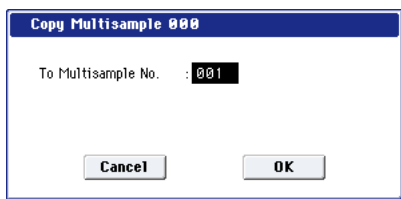

- Specify the copy destination multisample number.

**[Stereo]** When copying a stereo multisample, copy both the L and R channels of the copy destination multisample number.

- To execute the Copy Multisample command, press the OK button. To cancel, press the Cancel button.

 When a multisample is copied, the samples assigned to the multisample will also be copied at the same time. At this time, they will be automatically copied to vacant sample numbers. The sample data (waveform data) will be shared between the copy source and copy destination. (Additional sample memory area will not be consumed.)

### Rename MS (Rename Multisample)

This command modifies the name of the currently selected multisample.

- Use Multisample Select (MS) (0-1a) to select the multisample whose name you want to edit.
- Select Rename MS to open the dialog box.

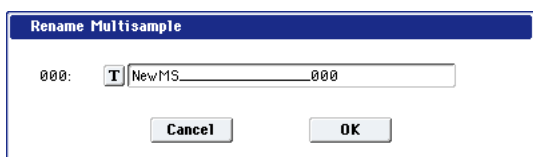

- Press the text edit button to move to the text edit dialog box, and input a multisample name of up to 24 characters.

**[Stereo]** If the selected multisample is stereo, up to 22 characters can be input as the multisample name. This is because the last two characters are reserved for -L and -R. If you rename up to 22 characters of the multisample of either the L or the R channel, the other multisample name will automatically be renamed.

- To execute the Rename Multisample command, press the OK button. To cancel, press the Cancel button.

### Convert MS (Multisample) To Program

This command converts the selected multisample into a program.

If you have recorded a sample or created a multisample and would like to play it in Program mode, Combination mode, or Sequencer mode, you must create a program that uses that multisample for its oscillator.

If you've created a multisample in Sampling mode and want to use it as a program, go to Program P2: OSC Pitch and set the OSC1 Multisample/Wave Sequence and OSC2 Multisample/Wave Sequence "Bank" parameters (if "Type" = Multisample) to RAM Mono or RAM Stereo. A multisample that you created in Sampling mode can be used in the program, and then to make program settings to specify how the multisample will be sounded.

However by executing the **Convert MS To Program** command, you can quickly and easily convert the Sampling mode settings into a new program, without having to make any Program mode settings as described above.

- Use Multisample Select (MS) (0-1a) to select the multisample that you want to convert to a program.
- Select Convert MS To Program to open the dialog box.

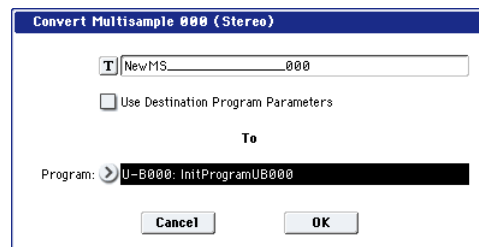

- Press the text edit button to open the text edit dialog box, and input a new program name (up to 24 characters).

By default, the multisample name will be used.

- If Use Destination Program Parameters is unchecked:

Executing the command will replace the multisample of the convert destination program with the multisample selected here, and will initialize the remaining program parameters.

The multisample will be converted into a single-oscillator Program.

If **Use Destination Program Parameters** is checked:

Executing this command will replace the multisample of the destination program with the multisample selected here, and will not initialize the remaining program parameters. Use this setting if you wish to use the parameter settings of an existing preset program, etc.

**Note:** **Use Destination Program Parameters** requires that the **Oscillator Mode** of the destination program be Single. If it is a Double or Drum program, the message "Oscillator Mode conflicts" will appear.

**5. In To Program, select the convert destination program.**

When the edit cell is selected, you can use the numeric keys 0–9, the VALUE dial, the VALUE slider, and  $\Delta/\nabla$  switches to make a selection. When you press the popup button, the Program Select menu will appear. Here you can select a program by bank.

We recommended that you use USER-G as the program bank for Sampling mode.

**6. To execute the Convert Multisample To Program command, press the OK button. To cancel, press the Cancel button.**

**MS Mono To Stereo/MS Stereo To Mono (Change Multisample Type)**

This command converts a mono multisample to stereo, or a stereo multisample to mono. If the selected multisample is mono, the dialog box will allow you to execute **MS Mono To Stereo**. If the selected multisample is stereo, the dialog box will allow you to execute **MS Stereo To Mono**.

1. Use **Multisample Select (MS) (0–1a)** to select the multisample that you want to change to stereo or mono.
2. Choose either **MS Mono To Stereo** or **MS Stereo To Mono** to open the dialog box.

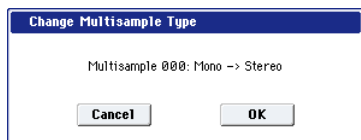

**3. To execute the Change Multisample Type command, press the OK button. To cancel, press the Cancel button.**

When you execute this command, the multisample type and sample assignment will change as follows.

**MS Mono To Stereo**

- The selected multisample will be converted to stereo. The last two characters of the multisample name will be overwritten as -L.
- An identical multisample will be newly created, but with the last two characters of the multisample name overwritten as -R.

- Mono samples assigned to the original multisample will be assigned to both -L and -R multisamples.
- If samples assigned to the original multisample are part of a stereo pair of samples, the -L and -R samples will be assigned to the -L and -R multisamples.

**[Stereo]: MS Stereo To Mono**

- The selected multisample will be converted to mono. The -L or -R at the end of the multisample name will be deleted.
- Multisamples that are stereo pairs of the selected multisample will be deleted.

**Move MS (Move Multisample)**

This command lets you move the currently selected multisample to the specified number (i.e., to change the multisample number), or to rearrange the multisample numbers so that they start from 000 after multisamples have become discontinuous as a result of creating or editing. (See diagram below)

When you reassign the multisample numbers, the multisample numbers within the programs that use these multisamples will also be automatically reassigned (according to the setting of step 4). (This means that you do not need to reselect the multisamples in Program mode following this operation.)

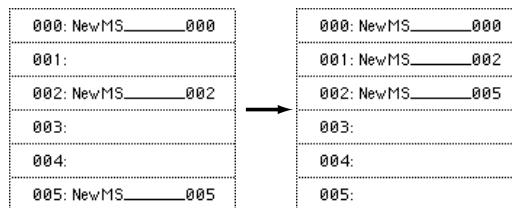

1. Use **Multisample Select (MS) (0–1a)** to select the multisample that you wish to move.
2. Select "Move MS" to open the dialog box.

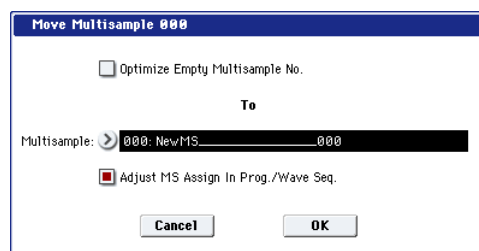

**3. In To Multisample, specify the move destination multisample number.**

**[Stereo]** When moving a stereo multisample, you will need to move each part separately.

If you wish to rearrange all multisamples consecutively, check "Optimize Empty Multisample No."

**4. If Adjust Multisample Assign in Program is checked and if the multisamples being moved are used in programs, the multisample numbers of the programs will also be reassigned automatically. Normally you will leave this checked.**



- To execute the Move Multisample command, click the OK button. If you decide not to execute, click the Cancel button.

**Example:** If data already exists at the move destination multisample number, the multisample will not be overwritten; instead, all subsequent multisamples will be renumbered upward.

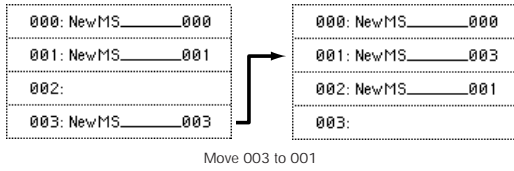

**Example:** If there is no empty multisample number and forward movement is not possible, multisamples will be renumbered downward.



## Optimize RAM

This command optimizes the RAM memory for Sampling Mode.

When you execute the optimize command, any memory areas containing unused data will be rearranged, allowing you to utilize all of the remaining memory.

If you run out of memory, try using **Optimize RAM**.

The remaining amount of RAM can be checked under “0–1f: Free Sample Memory/Locations,” as described on page 684.

- Select **Optimize RAM** to open the dialog box.

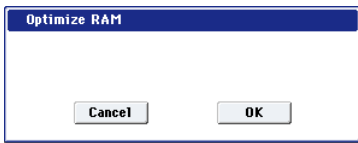

- Press the **OK** button to execute the optimize command, or press the **Cancel** button to cancel without executing.

*Note:* If **Auto Optimize RAM** (Global 0–1d) is checked, RAM will be optimized automatically.

## Select Directory/File for Sample to Disk

This command is available only when the Sampling Setup’s **Save To** parameter is set to Disk. It lets you set the disk, directory, and name for the WAVE file created by sampling. It also lets you audition WAVE files directly from disk, without needing to switch to Disk mode.

### Specifying the WAVE file’s disk, directory, and name

- Choose **Select Directory/File for Sample to Disk** to open the dialog box.

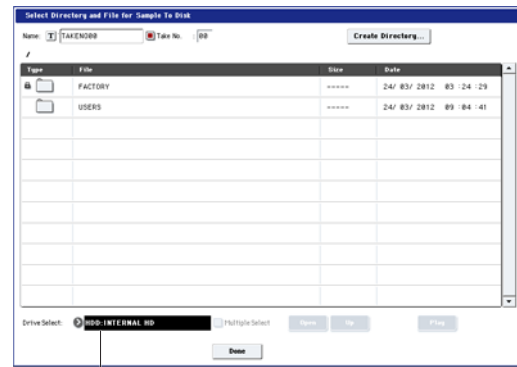

Drive Select

- Use **Drive Select** to choose a disk to record onto. You can record to either an internal disk or a USB storage device
- Use the **Open** button and **Up** button to move between directories.
- In the **Name** field, specify a name for the WAVE file.

If you check **Take No.**, a two digit “take number” will be added at the end of the filename when it is saved. The number will automatically increment each time you sample. When sampling repeatedly, this is convenient since it ensures that each file will be saved with a different filename.

- Press the **Done** button to complete the settings.

### Playing back a WAVE file

Once recorded, you can audition the sample directly from the **Select Directory/File for Sample to Disk** window; just select the file and press the **Play** button, as described below.

- Choose **Select Directory** to open the dialog box.
- Use **Drive Select**, the **Open** button, and the **Up** button to select a directory on disk, and then select the WAVE file that you want to play.

*Note:* only 16-bit or 24-bit, 44.1kHz or 48kHz WAVE files are supported. Other bit depths and sampling rates are not supported.

- Press the **SAMPLING START/STOP** switch or the **on-screen Play** button.

The selected WAVE file will play.

- To stop playback, either press the **SAMPLING START/STOP** switch again, or touch the on-screen **Stop** button.

⚠ If the WAVE file is mono, the same sound will be output to L and R.

## Auto Sampling Setup

This command automatically sets various sampling-related parameters for Sampling mode operations. You can use this command when you want to sample an

external audio source, or when you want to apply an effect to a sample and resample it. You can also use this command to initialize the settings.

- 🔍 When you execute this command, the applicable parameters will be set automatically. You cannot use the COMPARE switch to recall the previous settings.
- 🔍 The settings are automatically made for the most typical applications. After executing the auto setup operation, you can further adjust any of the settings to suit your needs as described in the “*Note:*” paragraphs of each section.

### 1. Select Auto Sampling Setup to open the dialog box.

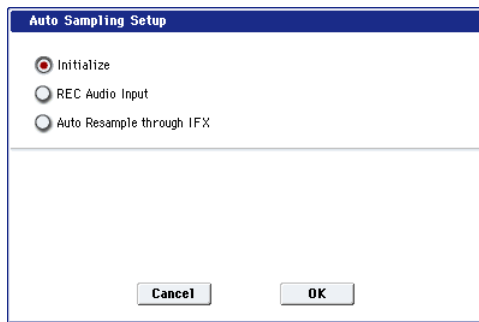

### 2. Use the radio buttons to select the type of settings you want to make.

**Initialize:** Initialize the sampling-related parameters to their default values.

**REC Audio Input:** Make settings for sampling an external audio source.

**Auto Resample through IFX:** Make settings for applying an effect to a sample and resampling it.

### 3. Specify the conditions. These will depend on what you select in step 2.

If you select Initialize:

Press the OK button to initialize the settings, or press the Cancel button if you decide not to execute. For more information, please see “Auto Sampling Setup: Automatically-set parameters and their values” on page 733.

If you select REC Audio Input:

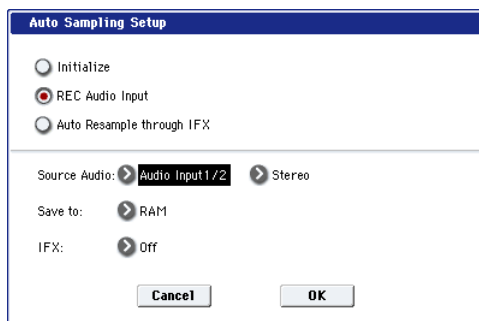

#### 1) Use “Source Audio” to select the external audio input source.

**Analog 1/2:** An analog audio source such as a musical instrument connected to the AUDIO INPUT 1 and 2 jacks will be input to the KRONOS.

**Analog 3/4:** An analog audio source such as a musical instrument connected to the AUDIO INPUT 3 and 4 jacks will be input to the KRONOS.

**S/P DIF:** Selects the digital audio output from an instrument or DAT etc. connected to the S/P DIF IN jack. (0–8a “Audio Input”)

2) Use “Mono-L/Mono-R/Stereo” to select the input source, and either mono or stereo as the number of channels that will be sampled.

**Mono-L:** Settings will be made for sampling to L-MONO from Input 1 (if you’ve selected Analog 1/2) or from Input 3 (if you’ve selected Analog 3/4).

**Mono-R:** Settings will be made for sampling to R-MONO from Input 2 (if you’ve selected Analog 1/2) or from Input 4 (if you’ve selected Analog 3/4).

**Stereo:** Settings will be made for sampling in stereo from Input 1/2 or 3/4.

3) Use **Save to** to specify the destination to which the sampled data will be written. RAM writes the data into Sampling mode. DISK creates a Wave file from the sampled data and saves it to disk.

4) If you want to apply an insert effect to the external audio input source while it is being sampled, use “IFX” to specify the insert effect that you want to use. If you don’t want to use an insert effect, set this Off.

5) Press the OK button to execute the REC Audio Input command, or press the Cancel button if you decide not to execute.

For more information, please see “Auto Sampling Setup: Automatically-set parameters and their values” on page 733.

*Note:* When you are ready to sample (after executing REC Audio Input), press the SAMPLING REC switch and then the SAMPLING START/STOP switch to begin sampling. (This is because **Trigger** is set to Sampling START SW.) When you’ve finished performing, press the SAMPLING START/STOP switch to stop sampling.

*Note:* Here’s how to check the data you just sampled. If you specified **Save to** RAM, play the C2 note of the keyboard to hear the sample. If you specified **Save to** DISK, use the menu command **Select Directory** to hear the sample.

*Note:* If you specified **Save to** DISK and want to change the save-destination for the Wave files, use the menu command **Select Directory**.

*Note:* If you want to change the way in which sampling is initiated, change the **Trigger** setting.

*Note:* If you selected S/P DIF for “Source Audio,” use **System Clock** (Global 0–1d) to change the system clock.

*If you select Auto Resample through IFX:*

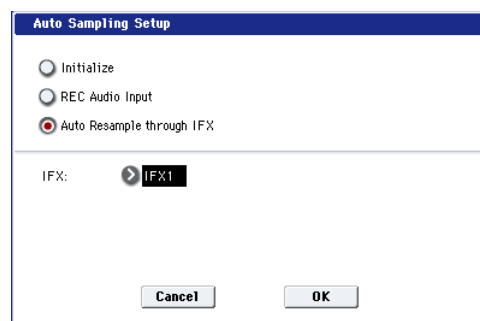



- 1) Use "IFX" to select the effect that you want to apply to the sample.
- 2) Press the OK button to execute Auto Sampling Setup (Auto Resample through IFX), or press the Cancel button if you decide not to execute. For more information, please see "Auto Sampling Setup: Automatically-set parameters and their values" on page 733.

Note: When you are ready to resample (after executing Auto Resample through IFX), perform the following steps.

- 1) Use **Key** (0–8c) to specify the key to which the sample you want to resample is assigned.

- 2) Use P8: Insert Effect to make effect settings. To hear the sound, play the note you specified in **Key**.
- 3) To begin resampling, press the SAMPLING REC key and then the SAMPLING START/STOP switch. (This is because **Trigger** is set to Sampling START SW.) The sample will play, and when playback ends, it will be resampled.

Note: To check the resampled data, play the note you specified in the **Key** parameter.

-  To prevent the insert effect from being applied "in duplicate" when you listen to the resampled data, "Bus Select All OSCs to" (8–1b) will automatically be set to L/R when resampling ends. If you want to apply IFX and resample once again, you will need to change this setting back to the same IFX.

### Auto Sampling Setup: Automatically-set parameters and their values

		[Initialize]	[REC Audio Input]	[Auto Resampling through IFX]
Input (Input Source)*1		Input 1& 2, USB 1& 2, S/P DIF	[Source Audio]*2	Input 1& 2, USB 1& 2, S/P DIF
Input1, USB 1, S/P DIF-L	Bus Select	Off	[IFX] <sup>*3</sup>	Off
	FX Ctrl Bus	Off	Off	Off
	REC Bus	Off	Off	Off
	Send1/2	000	000	000
	Pan	L000	L000	L000
	Level	127	127	127
Input2, USB 2, S/P DIF-R	Bus Select	Off	[IFX] <sup>*3</sup>	Off
	FX Ctrl Bus	Off	Off	Off
	REC Bus	Off	Off	Off
	Send1/2	000	000	000
	Pan	R127	R127	R127
	Level	127	127	127
Sampling Setup (Name)	Source Bus	L/R	L/R	L/R
	Source Direct Solo	(N/A)	(N/A)	(N/A)
	Trigger	Sampling START SW	Sampling START SW	Sampling START SW
	Metronome Precount	(N/A)	(N/A)	(N/A)
	Pre Trigger REC	–	–	–
	Resample	Manual	Manual	Auto
REC Sample Setup	Save to	RAM	[Save to]	RAM
	Mode	Stereo	[Source Audio] <sup>*4</sup>	Stereo
	Rec Level	+0.0	+0.0	+0.0
	Auto +12dB On	On	On <sup>*5</sup>	On
	Auto Loop On	On	–	–
Select Directly	–	–	–	–
Routing	Bus Select (All OSCs to)	L/R	–	[IFX]
	FX Ctrl Bus	Off	–	Off
	REC Bus	Off	–	Off
	Send1/2	127	–	000
Insert FX	Bus Select (Post IFX)	–	L/R <sup>*6</sup>	L/R <sup>*6</sup>

–: Not set automatically

[ ]: Set automatically according to the parameter settings in the dialog box

\*1 Edit sampling mode parameters

\*2 Uses the input source specified as Source Audio.

\*3: If IFX is Off this will be L/R. If IFX1...12 is selected this will be IFX1...12.

\*4 L-Mono if the Source Audio is Mono-L, R-Mono if it is Mono-R, and Stereo if it is Stereo

\*5 When Save to=RAM

\*6 Specify the BUS Select of that IFX1...12. If effects are chained, specify the last IFX in the chain.

### Truncate (for Sample Edit)

This command deletes unwanted data that lies outside the **Start** and **End** points. Use this command when you wish to delete silence at the beginning or end of the sample.

*Note:* If you wish to delete unneeded (unplayed) sample data after setting the **Start**, **Loop Start**, and **End** (2-1d), use the “Truncate (for Loop Edit)” page menu command found in P2: Loop Edit.

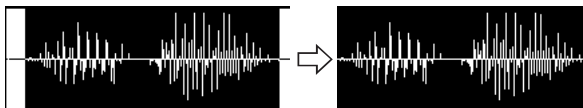

1. Use **Sample Select (1-1b)** to select the sample that you wish to edit, and use **Start** and **End** to specify the editing range.

You can press the **SAMPLING START/STOP** switch or **Play** button to hear the portion that will be left by the **Truncate** command.

2. Select **Truncate** to open the dialog box.

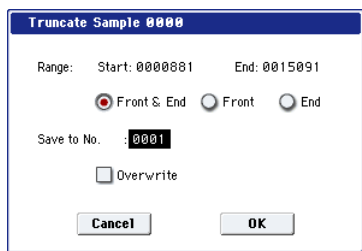

3. The editing range will be shown in **Range Start** and **End**.
4. Use the radio buttons to select the portion that will be deleted.

**Front & End:** The sample data that lies before the **Start** and after the **End** will be deleted.

**Front:** The sample data that lies before the **Start** will be deleted.

**End:** The sample data that lies after the **End** will be deleted.

5. In **Save to No.**, specify the save destination sample number.

By default, an unused sample number will be selected.

If **Overwrite** is checked, the sample number will be fixed to the current sample, and cannot be changed. See “About Overwrite” on page 726.

**[Stereo]** For stereo samples, use “Save to No.(L)” and “(R)” to specify the save-destination of the L and R channels.

6. To execute the **Truncate** command, press the **OK** button. To cancel, press the **Cancel** button.

### Cut

This command deletes the data between the **Start** and **End** points. Sample data located after the deleted portion will be moved toward the beginning of the sample.

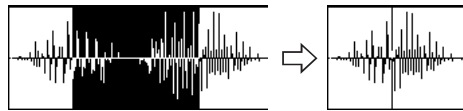

1. Use **Sample Select (1-1b)** to select the sample that you wish to edit, and use **Start** and **End** to specify the editing range.

You can press the **SAMPLING START/STOP** switch or **Play** button to hear the portion that will be deleted by the **Cut** command.

2. Select **Cut** to open the dialog box.

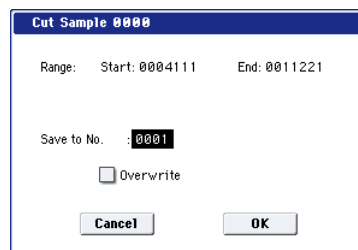

3. The range to be edited is shown by **Range Start** and **End**.
4. In **Save to No.**, specify the save destination sample number. By default, an unused sample number will be selected.

If **Overwrite** is checked, the sample number will be fixed to the current sample, and cannot be changed. See “About Overwrite” on page 726.

**[Stereo]** For stereo samples, use “Save to No.(L)” and “(R)” to specify the save-destination of the L and R channels.

5. To execute the **Cut** command, press the **OK** button. To cancel, press the **Cancel** button.

### Clear

This command converts the data between the **Start** and **End** points to zero values. Sample data before and after the edited range will not move.

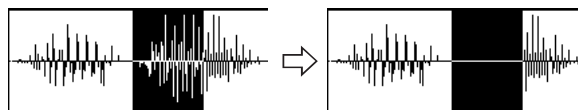

1. Use **Sample Select (1-1b)** to select the sample that you wish to edit, and use **Start** and **End** to specify the editing range.

You can press the **SAMPLING START/STOP** switch or **Play** button to hear the portion that will be changed to zero-level by the “Clear” command.

2. Select “**Clear**” to open the dialog box.

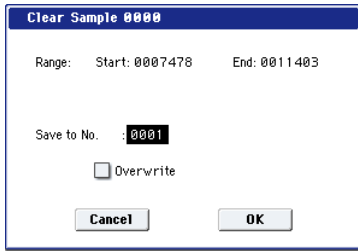

3. The range to be edited is shown by Range Start and End.
4. In Save to No., specify the save destination sample number. By default, an unused sample number will be selected.

If Overwrite is checked, the sample number will be fixed to the current sample, and cannot be changed. See "About Overwrite" on page 726.

**[Stereo]** For stereo samples, use "Save to No.(L)" and "(R)" to specify the save-destination of the L and R channels.

5. To execute the Clear command, press the OK button. To cancel, press the Cancel button.

## Copy

This command copies the sample data from the area between the **Start** and **End** points into the sample data buffer. This data can then be used by the **Insert**, **Mix**, or **Paste** commands.

- When you execute **Copy**, the data that is copied into the buffer actually consists only of the source sample number and the **Start** and **End** locations—not the data itself. Do not delete the source sample until you finish executing the **Insert**, **Mix**, or **Paste** command.

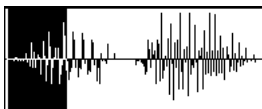

1. Use Sample Select (1–1b) to select the sample that you wish to edit, and use **Start** and **End** to specify the editing range.

You can press the SAMPLING START/STOP switch or Play button to hear the portion that will be copied by the **Copy** command.

2. Select **Copy** to open the dialog box.



3. The range to be copied is shown by Range Start and End.
4. To execute the Copy command, press the OK button. To cancel, press the Cancel button.

## Insert

When you execute this command, the sample data placed in the buffer by executing **Copy** in the Sampling mode Sample Edit page will be inserted at the **Start** address. The data that follows this address will be moved toward the end of the sample.

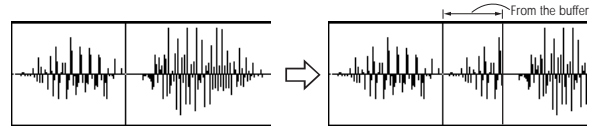

1. Use Sample Select (1–1b) to select the sample that you wish to edit, and set **Start** to specify the starting address. The **End** setting is ignored.
2. Select **Insert** to open the dialog box.

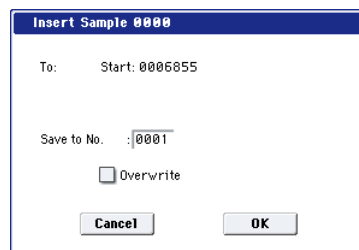

3. **To Start** will indicate the starting address at which the data will be inserted.
4. In **Save to No.**, specify the save destination sample number. By default, an unused sample number will be selected.

If Overwrite is checked, the sample number will be fixed to the current sample, and cannot be changed. See "About Overwrite" on page 726.

**[Stereo]** For stereo samples, use "Save to No.(L)" and "(R)" to specify the save-destination of the L and R channels.

5. To execute the **Insert** command, press the OK button. To cancel, press the Cancel button.

- If the buffer into which data was placed by the **Copy** command contains no data, the display will show the message, "Source sample is empty."

## Mix

When you execute this command, the sample data placed in the buffer by executing **Copy** in the Sampling mode Sample Edit page will be mixed with the selected sample data, starting at the **Start** address.

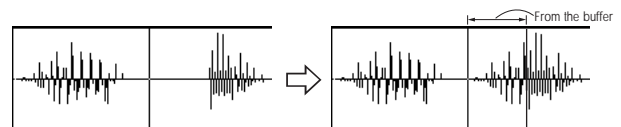

1. Use Sample Select (1–1b) to select the sample that you wish to edit, and set **Start** to specify the starting address. The **End** setting is ignored.
2. Select **Mix** to open the dialog box.

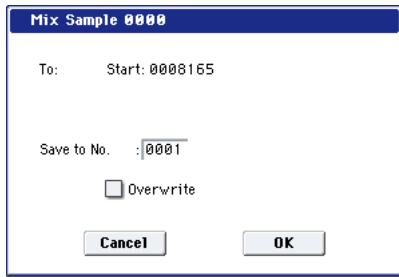

3. To Start will indicate the starting address at which the data will be mixed.
4. In Save to No., specify the save destination sample number. By default, an unused sample number will be selected.

If Overwrite is checked, the sample number will be fixed to the current sample, and cannot be changed. See "About Overwrite" on page 726.

**[Stereo]** For stereo samples, use "Save to No.(L)" and "(R)" to specify the save-destination of the L and R channels.

5. To execute the Mix command, press the OK button. To cancel, press the Cancel button.

 If the buffer into which data was placed by the Copy command contains no data, the display will indicate "Source sample is empty."

## Paste

When you execute this command, the sample data placed in the buffer by executing Copy in the Sampling mode Sample Edit page will be placed in the sample starting at the Start address. The original data will be deleted, and overwritten by the sample data from the buffer.

You can also place sample data into a blank sample. This is convenient when you wish to Copy part of a sample and create a new sample based on it.

*Pasting to a sample that contains sample data*

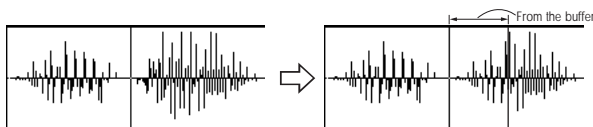

1. Use Sample Select (1-1b) to select the sample that you wish to edit, and set Start to specify the starting address. The End setting is ignored.
2. Select "Paste" to open the dialog box.

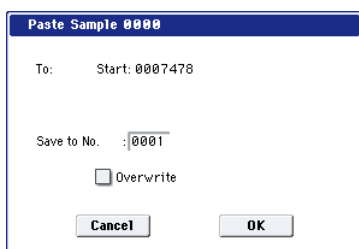

3. To Start will indicate the starting address at which the data will be pasted.
4. In Save to No., specify the save destination sample number. By default, an unused sample number will be selected.

If Overwrite is checked, the sample number will be fixed to the current sample, and cannot be changed. See "About Overwrite" on page 726.

**[Stereo]** For stereo samples, use "Save to No.(L)" and "(R)" to specify the save-destination of the L and R channels.

5. To execute the Paste command, press the OK button. To cancel, press the Cancel button.

 If the buffer into which data was placed by the Copy command contains no data, the display will indicate "Source sample is empty."

## Pasting to a sample that contains no sample data

1. Select the vacant sample number that you wish to paste.

If you select ----:---No Assign---- for Sample Select and then open the dialog box for this command, a vacant sample number will be selected automatically.

 The Start and End settings will be ignored, and will have no effect. The beginning of the sample will be placed at address 0.

2. Select "Paste" to open the dialog box.

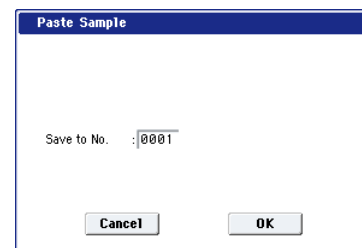

3. In Save to No., specify the save destination sample number. If you wish to change it, re-specify the desired number.

**[Stereo]** For stereo samples, use "Save to No.(L)" and "(R)" to specify the save-destination of the L and R channels.

4. To execute the "Paste" command, press the OK button. To cancel without executing, press the Cancel button.

## Insert Zero

This command inserts zero-level sample data (silence), beginning at the Start address. The data that previously occupied that location will be moved toward the end of the sample.

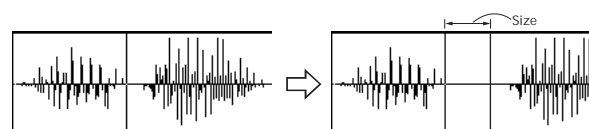

1. Use Sample Select (1-1b) to select the sample that you wish to edit, and set Start to specify the starting address. The End setting is ignored.
2. Select "Insert Zero" to open the dialog box.

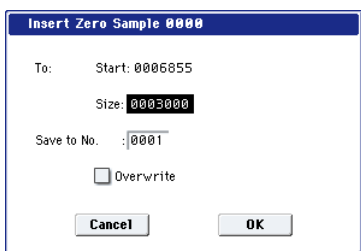

3. To Start will indicate the starting address at which the data will be inserted.
4. In "Size," specify the length of the data that will be inserted.
5. In Save to No., specify the save destination sample number. By default, an unused sample number will be selected.

If Overwrite is checked, the sample number will be fixed to the current sample, and cannot be changed. See "About Overwrite" on page 726.

**[Stereo]** For stereo samples, use "Save to No.(L)" and "(R)" to specify the save-destination of the L and R channels.

6. To execute the Insert Zero command, press the OK button. To cancel, press the Cancel button.

## Normalize/Level Adjust

This command uniformly modifies the data values (volume) of the data between the **Start-End**. **Normalize** will amplify the level of the sample data as far as possible without allowing it to clip (distort). If the level of the sampled data is too low, you can execute this command to increase the dynamic range. **Level** allows you to raise or lower the level as desired.

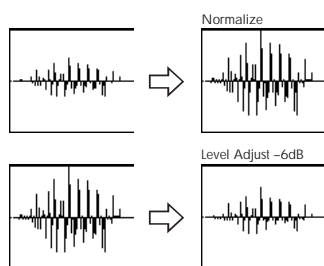

1. Use Sample Select (1-1b) to select the sample that you wish to edit, and use Start and End to specify the editing range.

You can press the SAMPLING START/STOP switch or Play button to hear the portion that will be normalized or level-adjusted.

2. Select Normalize/Level Adj. to open the dialog box.

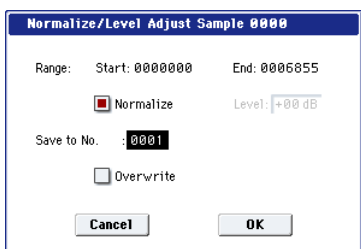

3. The range to be edited is shown by Range Start and End.
4. If you check **Normalize** and execute, the data will be normalized. In this case, the Level setting will be ignored.

If you wish to specify **Level** to modify the level of the sample data, do not check **Normalize**.

Each increase of +6 dB will approximately double the height of the waveform shown in the LCD.

+12 dB will be an increase of approximately 4X, and +18 dB will be approximately 8X. Conversely, each decrease of -6 dB will halve the level, so that -6 dB will be 1/2X and -12 dB will be approximately 1/4X.

Executing the **Level** command with positive (+) settings may cause the sound to clip (i.e., distort at the point that amplification beyond the maximum level is impossible). Once the sample data has been boosted beyond the clipping point, re-executing this command with negative (-) settings of **Level** will simply lower the overall level of the clipped signal – the waveform will remain distorted.

Also, if executing **Level** with negative (-) settings causes any portion of the sample data to reach a zero level, the zero data will not return to its original state even if you re-execute **Level** with positive (+) settings.

5. In Save to No., specify the save destination sample number. By default, an unused sample number will be selected.

If Overwrite is checked, the sample number will be fixed to the current sample, and cannot be changed. See "About Overwrite" on page 726.

**[Stereo]** For stereo samples, use "Save to No.(L)" and "(R)" to specify the save-destination of the L and R channels.

6. To execute the Normalize/Level Adjust command, press the OK button. To cancel, press the Cancel button.

**⚠** Be aware that if sample data of an extremely low level is normalized, any noise included in the sample will also be amplified.

## Volume Ramp

This command modifies the data values (volume) between the **Start** and **End**. You can make the volume gradually increase (Fade In) or decrease (Fade Out) from the **Start** to the **End**.

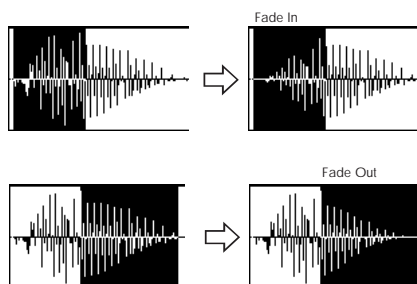

1. Use Sample Select (1-1b) to select the sample that you wish to edit, and use Start and End to specify the editing range.



You can press the SAMPLING START/STOP switch or Play button to hear the portion on which “Volume Ramp” will be executed.

2. Select “Volume Ramp” to open the dialog box.

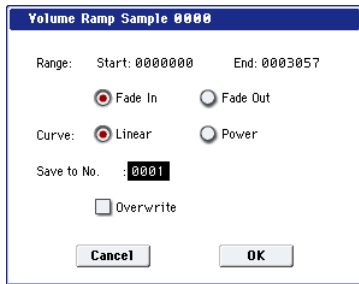

3. The range to be edited is shown by Range Start and End.
4. Use the radio buttons to select the type of volume ramp.  
**Fade In:** The volume at Range Start will be zero, and will gradually increase toward End.  
**Fade Out:** The volume will gradually decrease from the Range Start volume until it reaches zero at End.
5. In Curve, specify the way in which the volume will change.  
**Linear:** The volume will change linearly. For normal fade-in or fade-out, select Linear.  
**Power:** The volume will change non-linearly. When you use the Mix menu command to combine a faded-in waveform with a different faded-out waveform (i.e., crossfade), using a Linear fade-in/out may produce an impression that the volume has dropped in the middle of the curve. In such cases, use Power to perform the fade-in/out.
6. In Save to No., specify the save destination sample number. By default, an unused sample number will be selected.

If Overwrite is checked, the sample number will be fixed to the current sample, and cannot be changed. See “About Overwrite” on page 726.

**[Stereo]** For stereo samples, use “Save to No.(L)” and “(R)” to specify the save-destination of the L and R channels.

7. To execute the Volume Ramp command, press the OK button. To cancel, press the Cancel button.

## Rate Convert

This command lowers the sampling rate (frequency) of the sampled data by 2/3, 1/2, 1/3, 1/4, or 1/6. You can use this command to create “down-sampling” effects. The sample data is thinned to convert it to the lower sampling frequency.

The Rate Convert command is always executed on all waveform data of the selected sample, regardless of the Start and End settings.

1. Use Sample Select (1–1b) to select the sample that you wish to edit.
2. Select Rate Convert to open the dialog box.

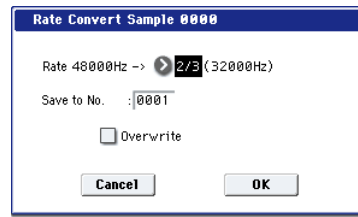

3. The sampling rate of the selected sample is shown at the right of “Rate.” At the right of the “→” you can select the desired amount of the sampling rate conversion: 2/3, 1/2, 1/3, 1/4 1/6. The sampling rate following conversion will be displayed in Hz.
4. In Save to No., specify the save destination sample number. By default, an unused sample number will be selected.  
 If Overwrite is checked, the sample number will be fixed to the current sample, and cannot be changed. See “About Overwrite” on page 726.
5. To execute the Insert Zero command, press the OK button. To cancel, press the Cancel button.

- ⚠ This command cannot be executed on a sample whose sampling rate is 192Hz or less.
- ⚠ The left and right channels of a Stereo sample must have the same sampling rate. Although it is possible to select mono multisamples for -L and -R and convert their sampling rate separately, the system will then no longer be able to handle the pair as a stereo sample.

## Reverse

This command reverses the sample data (i.e., exchanges the beginning and end).

The Reverse command is always executed on all waveform data of the selected sample, regardless of the Start and End settings.

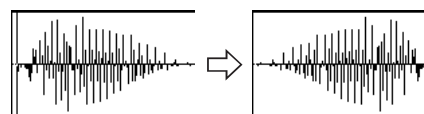

1. Use Sample Select (1–1b) to select the sample that you wish to edit.
2. Select Reverse to open the dialog box.

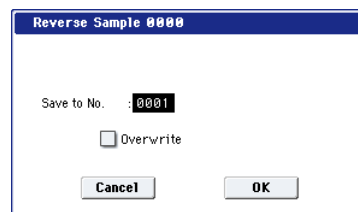

3. In Save to No., specify the save destination sample number. By default, an unused sample number will be selected.

If Overwrite is checked, the sample number will be fixed to the current sample, and cannot be changed. See “About Overwrite” on page 726.

**[Stereo]** For stereo samples, use “Save to No.(L)” and “(R)” to specify the save-destination of the L and R channels.

4. To execute the Reverse command, press the OK button. To cancel, press the Cancel button.

*Note:* When you execute this command, all of the sample data will be rewritten to reverse its direction. The P2: Loop Edit also contains a **Reverse** (2-1d) command, which simply reverses the playback direction without affecting the sample data itself.

## Link

This command connects the currently selected sample with another sample.

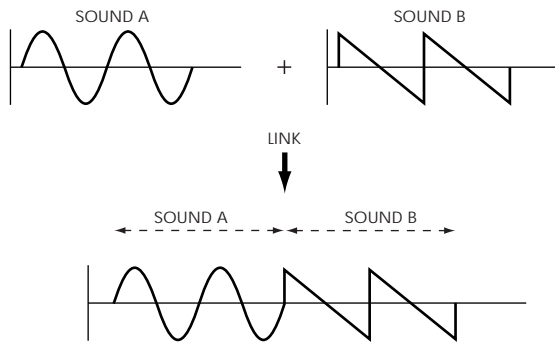

The volume of the two samples can be changed gradually at the transition to gradually mix the samples with each other. This is called crossfade, and can be used to produce a natural-sounding transition between the two sounds.

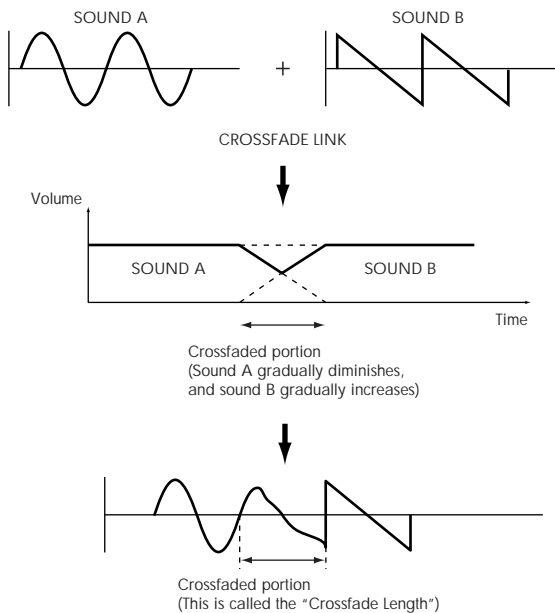

**Link** will be executed for all of the selected sample data, regardless of the **Start** and **End** settings.

1. Use **Sample Select (1-1b)** to select the sample that will be placed in front by the **Link** command.
2. Select **Link** to open the dialog box.

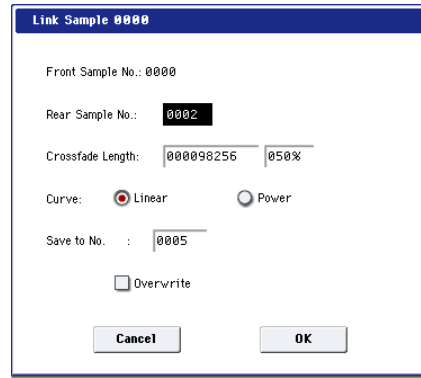

3. The sample number selected for **Front Sample No.** will be displayed. When the command is executed, this sample will be placed in front.

**[Stereo]** If you select one side of a stereo sample, it will automatically be detected as a stereo sample, and the other side of the sample will also be processed by the **Link** command.

If the **Front** Sample is mono and the **Rear** Sample is stereo, the L and R of the **Rear** Sample will be mixed to mono before linking.

If the **Front** Sample is stereo and the **Rear** Sample is mono, the identical sample will be placed in L and R of the **Rear** Sample before linking.

4. Use **Rear Sample No.** to select the sample number that will be linked.

When the command is executed, this sample will be placed in back.

5. In **Crossfade Length**, specify the length over which the crossfade will occur.

If you specify a % value, the proportion in relation to the entire **Front** Sample will be calculated automatically. If you specify 50%, the last half of the **Front** Sample will crossfaded.

- ⚠** If the rear sample is short, the **Crossfade Length** cannot be set any longer than the length of the **Rear** sample. In this case, it will not be possible to specify a value up to 100%.



After selecting a sample in step 1, you can set **Start** and specify the beginning of the crossfade while viewing the waveform. Set **End** to the end of the sample. If you specify these, **Crossfade Length** will indicate the length determined by **Start** and **End**.

6. In “**Curve**,” specify how you want the volume to change in the crossfaded portion.



**Linear:** The volume will change linearly.

**Power:** The volume will change non-linearly. In some cases, **Linear** may sound as though the volume diminishes in the middle of the curve. If this occurs, use **Power**.

**7. In Save to No., specify the save destination sample number.**

An unused sample number will be selected by default.

If Overwrite is checked, the sample number will be fixed to the current sample, and cannot be changed. See "About Overwrite" on page 726.

**[Stereo]** For stereo samples, use "Save to No.(L)" and "(R)" to specify the save-destination of the L and R channels.

**8. To execute the Link command, press the OK button. To cancel without executing, press the Cancel button.**

 If you link samples of different sampling rates (such as created by **Rate Convert**), the newly created sample will have the sampling rate of the **Front** sample.

 One vacant sample is used in order to execute Link. Be aware that if there are no vacant samples, an error will occur.

**Truncate (for Loop Edit)**

This command deletes unwanted data that lies outside of the **Start**, **Loop Start**, and **End** points (2-1d). After setting the start address, loop start address, and end address of the sample, use this command to delete unwanted sample data.

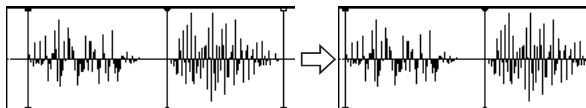

**1. Use Sample Select (2-1b) to select the sample that you want to edit, and use the Start or Loop Start points and the End point to specify the region that you want to edit.**

**2. Select Truncate to open the dialog box.**

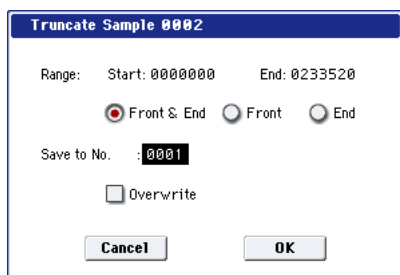

**3. Range Start and End will show the range of data that will be edited.**

**4. Use the radio buttons to select the portion that will be deleted.**

**Front & End:** The sample data that lies before the **Range Start** (start address or loop start address) and after the **Range End** (end address) will be deleted.

**Front:** The sample data that lies before the **Range Start** (start address or loop start address) will be deleted.

**End:** The sample data that lies after the **Range End** (end address) will be deleted.

**5. In Save to No., specify the save destination sample number. By default, an unused sample number will be selected.**

If Overwrite is checked, the sample number will be fixed to the current sample, and cannot be changed. See "About Overwrite" on page 726.

**[Stereo]** For stereo samples, use "Save to No.(L)" and "(R)" to specify the save-destination of the L and R channels.

**6. To execute the Truncate command, press the OK button. To cancel, press the Cancel button.**

**Time Slice**

**Time Slice** lets you convert a mono or stereo rhythmic sample, such as a drum loop, into a set of individual hits and matching sequencer data. You can then:

- Re-create the loop by playing the sequencer data
- Change the tempo of the loop, without altering the pitch
- Change the pitch of the samples, without altering the tempo
- Change the rhythmic feel by altering quantization, swing, etc.
- Change the pattern of the loop by swapping or deleting individual hits, or otherwise editing the sequencer or sample data

In detail, **Time Slice** does the following:

- Detects the individual beats in the original loop
- Splits each beat into a separate sample
- Creates a Multisample with the original loop on the note C2, and the individual beats on separate keys starting on D2
- Creates a Program which uses the new Multisample
- Creates Sequencer data to re-create the sound of the original loop by playing the individual hits

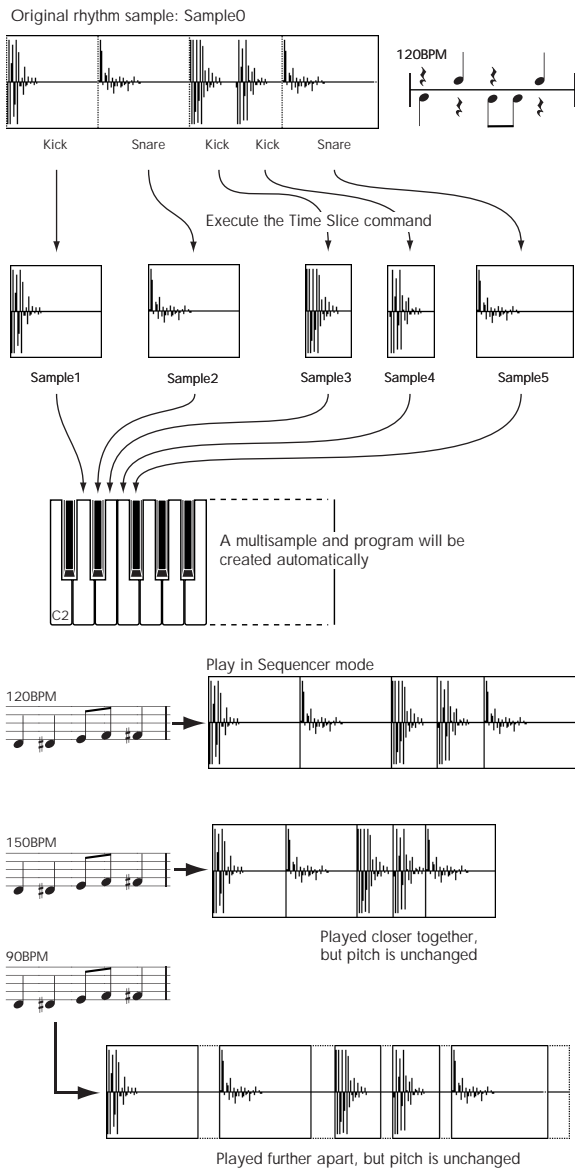

\* You can also use the Time Stretch command to control the compression of each sample to optimize the "spacing" to match the tempo. step 9

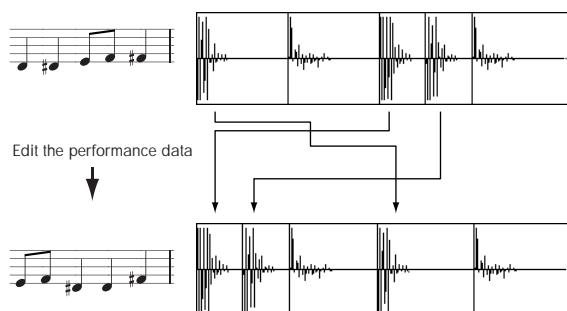

Note: As an alternative to the **Time Slice** command, the **Time Stretch** menu command is another way to change the tempo of a rhythm loop or similar sample. You may wish to use this if you don't need to divide the sample and create song performance data for the divided samples.

1. Select the sample in the Sample Select (2-1b) for which you wish to execute Time Slice.

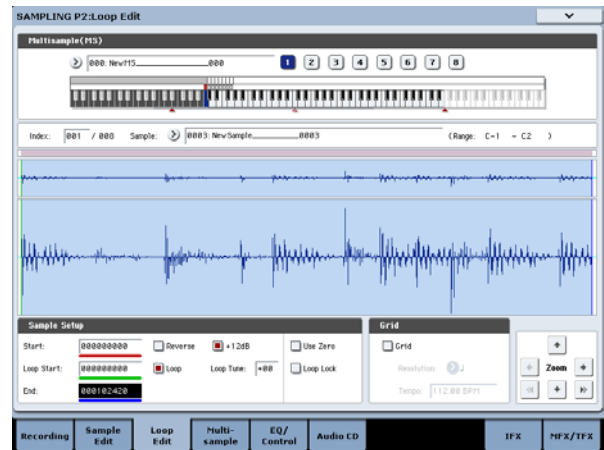

2. Select the Time Slice to open the dialog box.

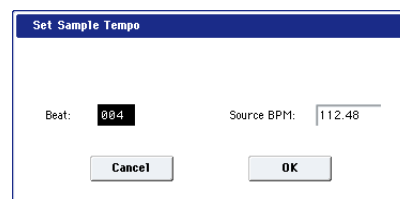

3. Specify the number of quarter-note beats and tempo of the currently selected sample. If you know the BPM of the original waveform, set **Source BPM**. If you do not know the BPM, specify **Beat** and the BPM will be calculated automatically.

The setting you make here will be used as the reference value when detecting the attack, when performing Time Stretch in step 9b, and when saving the sequence data in step 10.

**Beat:** Specifies the number of quarter-note beats. When you specify **Beat**, the **Source BPM** will indicate the playback BPM at the original key. This BPM value will automatically be calculated from the start address to the end address (if loop is off) or from the loop start address to the end address (if loop is on) of the selected sample. If you know the BPM and it is different than the displayed value, change **Source BPM** to the correct value.

For example in the case of a 120 BPM sample of one measure of 4/4 time, set **Beat** to 4. The **Source BPM** will be calculated automatically. If the **Source BPM** is not set to 120.00, due to inaccuracies in the start address (or loop start address) and end address, change the **Source BPM** to 120.00.

**Source BPM:** Specifies the tempo at the original key of the source waveform.

4. To execute Time Slice, press the OK button. To cancel without executing, press the Cancel button.

When you press the OK button, the attacks will be detected, the sample will automatically be sliced, and a dialog box will appear.

**[Stereo]** In the case of a stereo sample in which L and R have different lengths, silent data will automatically be added to the end of the shorter sample so that the two samples will be the same length.

⚠ If you want to re-set **Beat** and **Source BPM** after pressing the OK button, you can do so in step 9a).

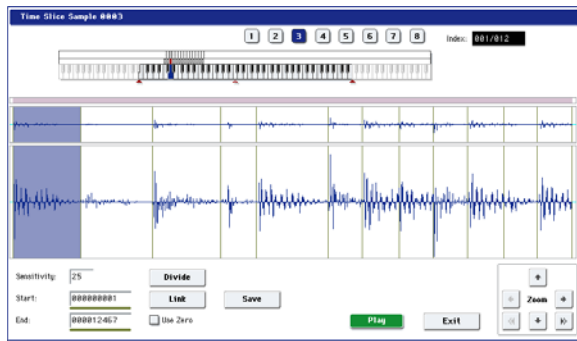

**5. Listen to the samples that were divided by detecting their attacks.**

The sample before slicing is assigned to the C2 note of the keyboard, and the sliced samples are assigned to notes D2 and above. When you change the **Index**, the corresponding display will be highlighted, allowing you to view the sliced waveforms.

*Time Slice step 4*

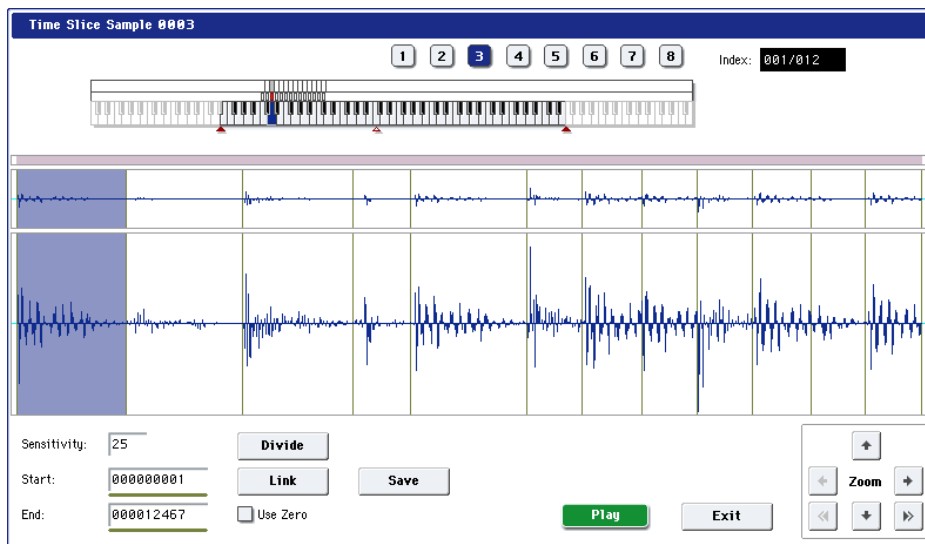

**Index [Source, xxx(001...090)/yyy(001...090)]**

Selects the sample index.

If this is set to Source, the original waveform before time slicing will be selected.

By selecting xxx/yyy you can specify individual samples that were sliced. xxx indicates the selected sample, and yyy indicates the total number of samples that were sliced. A maximum of 90 samples can be assigned to the keyboard. If more than 90 samples were sliced, this will display 90.

**Sample waveform display:** Gray lines indicate the locations at which the sample is sliced. Red and blue lines indicate the Start and End addresses respectively. When **Index** is xxx/yyy, the sample of the selected index will be highlighted.

[Stereo] In the case of a stereo sample, the L channel sample data will be displayed above, and the R channel sample data will be displayed below.

**ZOOM:** You can zoom in and zoom out in the vertical and horizontal dimensions of the waveform shown in the sample waveform display. (1-1f)

You can also select an index by holding down the ENTER switch and pressing a note on the keyboard. The index that is assigned to the note you pressed will be selected.

To hear the sliced sounds, you can either press the corresponding note on the keyboard, or change the index to select the desired sample and then press the SAMPLING START/STOP switch. When you press the SAMPLING START/STOP switch, the sound between the specified **Start** and **End** will be played at the original key.

**Keyboard & Pads:** This shows the multisample that is being used temporarily in this dialog box.

When you play the keyboard, this multisample will sound. It will behave in the same way as in normal pages (such as the Recording page). (0-1a)

[Stereo] In the case of a stereo sample, a stereo multisample will be temporarily used. The sample at each index will sound in stereo.

**6. If the slice locations are not appropriate, you can adjust Sensitivity to change the sensitivity at which the attacks are detected, in order to change the slice locations.**

**Sensitivity [00...30]**

Adjusts the sensitivity at which the attacks are detected. By increasing this value, you can detect attacks at even lower levels, to create more finite slices.

⚠ The **Level** in this case does not necessarily correspond to the “waveform level.”

Depending on the sample, the desired slicing may not occur even if you increase the **Sensitivity**. If the attack portion of the following sample has overlapped into the end of the sample, or if the sample contains two sounds, make adjustments in step 7.

**7. Make adjustments where the automatic attack detection did not occur correctly.**

Change **Index** to select the sample that you wish to adjust. Make adjustments by changing **Start** and

**End**, and by executing **Divide** or **Link** to adjust the slice location.

**Start**: Specify the start address for the sample of the currently selected **Index**. At the same time, the end address of the sample for the preceding **Index** will also be adjusted.

**End**: Specify the end address for the sample of the currently selected **Index**. At the same time, the start address of the sample for the next **Index** will also be adjusted.

When adjusting the **Start** and **End** addresses of the divided samples, use **ZOOM** to increase the magnification (x1 or more) so that the sample waveform is displayed accurately when you make adjustments. (1-1f)

 If **Index** is set to Source, the address of the original waveform will be modified. If you change the start address, the loop start address will also be changed at the same time.

Use Zero: (1-1d)

If you wish to adjust the **Start** or **End** of a divided sample, it is best to first check **Use Zero**. In general, using zero-cross points to specify sample addresses will make it less likely that clicks or pops will occur, particularly at the **End**.

**Divide**: This splits the sample of the currently selected **Index** into two. Use this when you wish to add another location to slice the sample. Modify **End** or **Start** to adjust the divided sample.

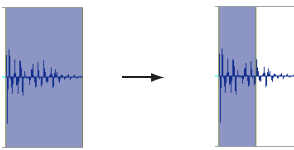

**Link**: This joins the sample of the currently selected **Index** to the sample of the next **Index**. Use this when you wish to merge together two sliced locations.

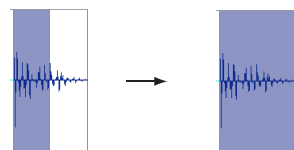

When you use Time Slice on a rhythm loop sample, the quality of the playback in Sequencer mode will depend largely on the "cutoff" of each percussion instrument sound that was sliced.

 Be aware that if you change the **Sensitivity** after adjusting the slice location, the attacks will be re-detected and the sample will automatically be sliced again.

**What kind of slices will produce the best result?**

A. Divide the separate percussion instrument notes as finely as possible

For example in the case of a sample where the decay of the kick is overlapped by the hi-hat, the attack sound of the kick and the attack sound of the hi-hat should be sliced to create two samples. If these sounds are left as one sample (containing both kick and hi-hat), their rhythm may become incorrect when the sample is played at a different tempo.

Kick + Hi-hat kick/Hi-hat

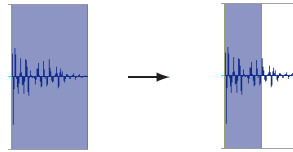

If the sample is not sliced appropriately even after you adjust the **Sensitivity** use **Divide** to divide the sample into halves, and adjust **End** and **Start** as needed.

B. Make sure that each divided sample has a clear attack

The attack portion is vital for percussion sounds. Slice the sample at a point where the attack will be sounded crisply.

C. Avoid the noise that can occur toward the end of each divided sample

For example as shown in the above right illustration, noise can be present at the end of the kick sample. Adjust the end address of the kick sample so that the noise is not obtrusive.

In this case, adjusting the end address will also affect the start address of the hi-hat sample. While listening to the two samples, make adjustments so that the noise at the end of the kick sample is as inconspicuous as possible, and also that the hi-hat attack is heard cleanly.

Pay attention to these points as you adjust **Sensitivity**. If necessary, use the methods described above to edit each sample.

The noise occurring at the end of the sample in "C." will be automatically reduced when you execute steps 8 and following. You should adjust **Sensitivity** while paying particular attention to sections "A" and "B," and then execute step 9. If the noise is still obtrusive, then you can adjust the end address.

**8. Save the sliced samples to the multisample to which they have been assigned.**

When you press the Save button, the "Save Samples & MS" dialog box will appear.

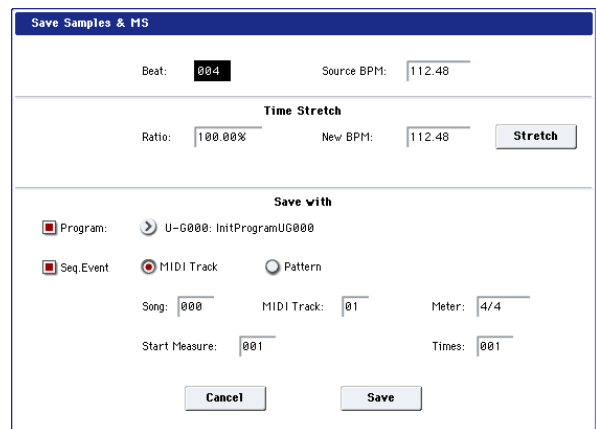

**9. Use Time Stretch to adjust the length of the sliced samples.**

When you press the Stretch button, Time Stretch (a function that expands or shrinks the length of a sample without affecting its pitch) will be applied to the sliced sample.

If you wish to save the sliced sample as it is, proceed to step 10 without executing Time Stretch.

Sometimes when a sliced sample is played in Sequencer mode and the tempo is slowed down, the silent portion between samples may become obvious or noise may be more apparent, producing an unnatural-sounding result. To avoid this, you can use Time Stretch to adjust the length of the individual samples. The length of the samples will automatically be optimized according to the **Ratio** and **New BPM** settings.

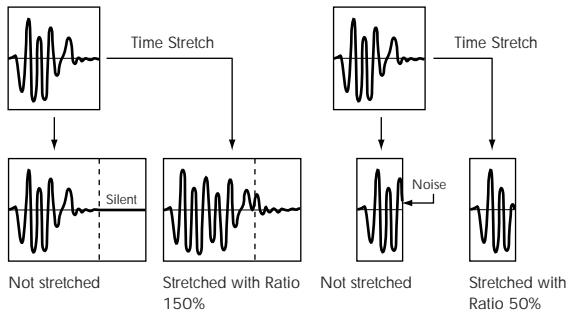

If you execute Time Stretch at 100%, the sample length will not change but the end of the sample will be faded out, reducing the noise.

a) Set **Beat** and **Source BPM**. The method is the same as in step 3. If you wish to change the value you set in step 3, you can change it here.

b) Specify the length of the sample that will be created by Time Stretch.

- To specify the length as a ratio

Set **Ratio**. The available range is 50.00–200.00%. If you specify 50.00%, the sample length will be halved. (The tempo will double.) If you specify 200.00%, the sample length will double. (The tempo will be halved.)

- To match an existing BPM tempo value

Use **New BPM** to specify the BPM value of the sample you wish to create. The **Ratio** will automatically be calculated from the **Source BPM** and the **New BPM** values.

It is not possible to make settings that would cause **Source BPM** or **New BPM** to exceed the range of 40.00–480.00.

It is not possible to make settings that would cause **Ratio** to exceed the range of 50.00–200.00.

Press the Stretch button to execute Time Stretch.

When you execute the command, the time-stretched samples will automatically be assigned to notes D2 and above of the keyboard, allowing you to audition the sound. You can change **Ratio** and **New BPM** as many times as desired and continue auditioning the result.

When you audition the time-stretched samples, the sound you hear is the sound of each divided sample as it will be played in Sequencer mode. If there is obtrusive noise or if the attack is not sound cleanly, return to step 7 and adjust the **Start** and **End** addresses, etc.

10. Set "Save with" to specify the data that will be created simultaneously when you press the Save button to save the samples

**Program:** If this check box is checked, the multisample will be converted to a program when you save it. Specify the destination program number.

**Seq.Event:** If this check box is checked, sequence data to play the sliced samples will automatically be created after the data is saved.

You can specify whether the sequence data to play back the sliced samples will be created as track data or as pattern data. If pattern data is created, you can also assign the pattern to RPPR.

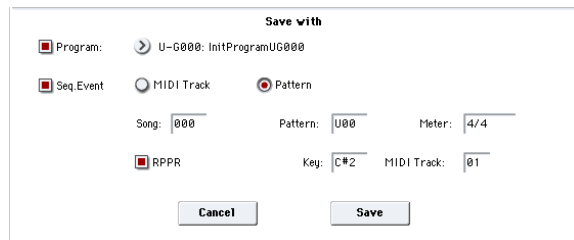

If you choose the Track radio button, track data will be created. Use **Song**, **Track**, and **Meter** to specify the song number, track number, and time signature of the data that will be created.

The track data that is created will start at the measure specified by **Start Measure**, and will repeat for the number of times specified by **Time**.

When track data is created, any data that had existed within the specified range of measures will be erased. Data outside this range will not be erased.

If you check both **Program** and **Seq.Event** and select the Track, the song parameter **Program Select** (Sequencer 0–1b) will automatically be specified if the **Start Measure** is 001. Also, a program change will be created at the **Start Measure** location. In Sequencer mode you can select the song and play it back to hear the result immediately. Normally you will check both of these boxes.

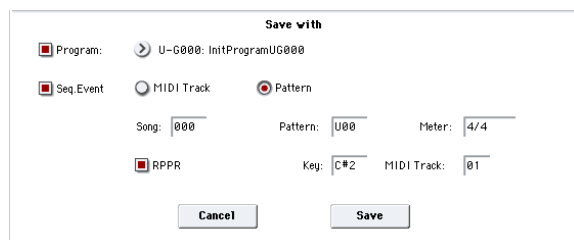

If you choose the Pattern radio button, pattern data will be created.

Use **Song**, **Pattern**, and **Meter** to specify the song number, pattern number, and time signature of the data that will be created.

**RPPR:** If you check the check box, pattern data to play the sliced samples will be assigned to RPPR when you save. Use **Key** and **Track** to specify the key and track that will be created.

If **Program**, **Seq.Event**, and **RPPR** are all checked, the song parameters **Program Select** (Sequencer 0–1c/2c) and **RPPR ON/OFF** (Sequencer 0–1a) will both be specified automatically. **RPPR ON/OFF** will be turned on.



In Sequencer mode you can select the song and pattern to play back the results immediately. If **RPPR** is checked, pressing the specified key will play the pattern. Normally you will check both of these boxes.

*Note:* In some cases, the sample End address setting etc. may increase the number of measures in the pattern, so that it no longer loops precisely. In such cases, re-specify the **Length** in the Sequencer mode **Pattern Parameter** menu command.

*Note:* If you use **Seq.Event** and **Start Measure 001**, the **Tempo** (0–1c) of the track data or pattern data that is created will be the value specified by **New BPM** if you executed Time Stretch. If you did not execute Time Stretch, the tempo will be the value specified for **Source BPM**.

If you set **Start Measure** to 001 and create a track, and if a tempo event exists only at the beginning of the master track, the tempo of that event will also be the value that you specified as **New BPM** or **Source BPM**.

 If you save to a song that already contains data, the time-sliced samples may not play back in the same way as original sample if the time signature is different. You must set a matching time signature in the master track.

**11. If you wish to save, press the Save button. If you decide not to save, press the Cancel button. When you save, the samples and multisample will automatically be saved to vacant samples and multisamples.**

**[Stereo]** In the case of stereo samples, the samples and multisample will be saved in stereo.

**12. By repeating steps 6–11 you can create as many samples and multisamples as desired.**

**13. Press the Exit button to exit the Time Slice command.**

 If you exit Time Slice without using the Save button to save the samples and multisamples, be aware that the samples and multisamples you create will be lost.

 Before executing **Time Slice** on a long sample, you should first divide the sample into measures. In some cases, it may not be possible to assign the sample to the keyboard or create sequence data.

**Time Slices** requires vacant samples, multisamples, and relative parameters in order to execute. Be sure that there is sufficient free area before you execute. If there is insufficient free area, an error will occur.

*Note:* If you open the **Time Slice** dialog box on the same sample, it will be sliced in the same way as previously. These slice locations will also be used if you execute Slice in the **Time Stretch** menu command, so that you don't have to make the settings again.

If you wish to detect the attacks again or to re-do the operation, change the **Sensitivity** after you open the dialog box.

## Time Stretch

Time Stretch lengthens or shortens a sample without changing its pitch. This is convenient when you wish to change the tempo of a rhythm loop (drums) or a melodic sample (e.g., vocal, strings, winds) to match the tempo of another sample or of the sequencer. The KRONOS provides two ways in which Time Stretch can be executed.

This command also supports stereo samples.

### Sustaining

This type is suitable for sustained sounds such as vocal or instruments. Using it to change the tempo of phrases such as guitar or piano will also produce good results.

### Slice

This type is suitable for decay-type instruments such as drums. Using it to change the tempo of drum or percussion loops will produce good results with minimal effect on the attack.

*Note:* It is possible to change the pitch when you adjust the tempo of a rhythm loop or similar sample, using the **Detune BPM Adjust** menu command. You can create interesting effects by raising or lowering the pitch of a drum sound. For more information, see “Detune BPM Adjust” on page 504.

### Using Time Stretch (Sustaining)

**1. Select the sample that you wish to time-stretch using the Sustaining method.**



**2. Select the Time Stretch command to access this dialog box, where you can select the desired time stretch method.**



**3. Use the radio buttons to select Sustaining. Then press the OK button to execute, or the Cancel button to cancel without executing.**

**[Stereo]** If the L and R of a stereo sample are different in length, blank data will automatically be added to

the end of the shorter sample so that it matches the longer side.

#### 4. The Time Stretch dialog box will appear.

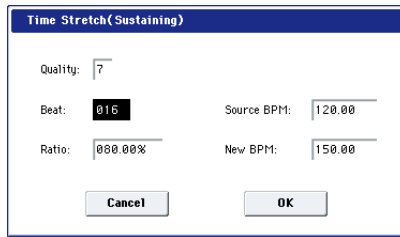

#### 5. Set Quality to specify the desired audio quality of the sample produced by Time Stretch.

The range is 0–7. Higher settings will generally produce better results (depending on the sample being processed), but will also increase the processing time.

Since you can try this as many times as you like, you should normally start with about 4, and raise or lower the setting gradually.

#### 6. Set the proportional length of the sample that will be created by Time Stretch.

- To specify the length as a ratio:

Set the **Ratio** to the desired value. The available range is 50.00%–200.00%.

50.00% reduces the sample to half of its original length, doubling the tempo.

200.00% increases the sample to double its original length, slowing the tempo to half-speed.

The tempo of the resulting sample will be calculated automatically based on the **Ratio** and **Source BPM**, and displayed in **New BPM**.

- To match an existing BPM tempo value:

Set **Beat** as the number of quarter-note beats. When you change **Beat**, the **Source BPM** value will be changed automatically.

**Source BPM** will indicate the playback BPM value at the original key. This BPM value is automatically calculated according to the length from the start address to the end address (if loop is off) or from the loop start address to the end address (if loop is on). If you already know the BPM value and the calculated value is incorrect, change it to the correct value.

Use **New BPM** to specify the BPM value of the sample you wish to create. **Ratio** will automatically be calculated from the **Source BPM** and **New BPM** values.

For example if you have a one-measure 120 BPM sample in 4/4 time, and would like to change it to 150 BPM, you would set **Beat** to 4. The **Source BPM** will be calculated automatically. If the **Source BPM** is not calculated as 120.00 due to inaccuracies in the start address (or loop start address) or end address, adjust **Source BPM** to the correct value of 120.00.

Next, set **New BPM** to 150.00. The **Ratio** will be calculated automatically.

- It is not possible to make settings that would cause **Source BPM** or **New BPM** to exceed the range of 40.00–480.00.

It is not possible to make settings that would cause **Ratio** to exceed the range of 50.00–200.00.

- Depending on the sample, the length may not be exactly as you specify, due to limitations in processing accuracy.

#### 7. To execute the Time Stretch operation, press the OK button. To cancel without executing, press the Cancel button.

When you press the OK button, the Time Stretch dialog box will appear.

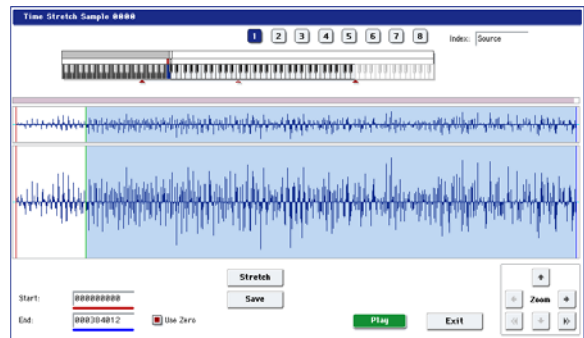

#### 8. Audition the sample that was created by Time Stretch.

The sample before being time-stretched is assigned to the C2 note of the keyboard, and the sample that was time-stretched is assigned to C#2. You can change the **Index** to check the waveform.

**Keyboard & Pads:** This shows the multisample that is used temporarily in this dialog box.

When you play the keyboard, this multisample will sound. It will behave just as in normal pages (e.g., the Recording page). (0–1a)

**[Stereo]** In the case of a stereo sample, a stereo multisample will be used temporarily. The sample at each index will sound in stereo.

#### Index

#### [Source, Result]

Selects the index for the sample whose waveform you wish to display.

If you select Source, the original waveform before time-stretching will be selected.

If you select Result, the time-stretched sample will be selected.

You can also select the index by holding down the ENTER switch and pressing a note on the keyboard. The index that includes that note will be selected.

**Sample waveform display:** This shows the waveform of the selected sample. As in 2–1: Loop Edit, the Start, Loop Start, and End addresses are shown by a solid line.

**[Stereo]** In the case of a stereo sample, the L channel sample data will be displayed above, and the R channel data below.

**ZOOM:** This controls horizontal and vertical zoom in/out for the waveform shown in the “Sample waveform display.” (1–1f)

Start:



End:

Specify the start address and end address of the sample for the currently selected index.

When you execute Time Stretch, the addresses will be specified automatically, but the playback may be slightly skewed due to inaccuracies in the end address, etc. If this occurs, you can correct the addresses manually.

- When you change the start address, the loop start address will also be changed simultaneously. If you wish to independently adjust the start address and loop start address, save the data in step 10, and then make settings in the P2: Loop Edit page.

To audition the sound in the specified range, play the keyboard or press the SAMPLING START/STOP switch. When you press the SAMPLING START/STOP switch, the sample in the range specified by **Start** and **End** will sound at the original key.

**Use Zero:** (1-1d)

- If you press the Stretch button, the Time Stretch dialog box will appear, and you can re-do the time stretch once again. Execute Time Stretch as described in step 6.
- Save the sample that you created. Press the Save button, and the Save dialog box will appear.

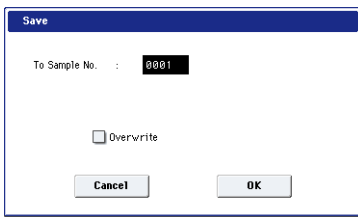

In "To Sample No.," specify the save destination sample number. By default, an unused sample number will be selected. If **Overwrite** is checked, this cannot be selected.

If Overwrite is checked, the sample number will be fixed to the current sample, and cannot be changed. See "About Overwrite" on page 726.

**[Stereo]** For stereo samples, use "Save to No.(L)" and "(R)" to specify the save-destination of the L and R channels.

To execute the Save operation, press the OK button. To cancel without saving press the Cancel button.

- By repeating steps 9-10 you can create more samples as desired.
- Press the Exit button to exit the Time Stretch operation.

The index will specify the last-saved sample number.

*Note:* If you to use the saved sample in Program mode or Sequencer mode, you can use the **Convert MS To Program** menu command, or you can select that multisample for the "2-1c: OSC1 Multisample/Wave Sequence" or "2-5: OSC2 Basic" parameters "MS1"-"M4" (if "Type" = Multisample) and create a program.

- Be aware that if you exit Time Stretch without using the Save button then press the OK button to save the sample, the sample(s) you created will be lost.

- Time Stretch requires vacant samples, multisamples, and relative parameters in order to execute. Before you execute, make sure that there is sufficient free space. If there is not, an error will occur.

**To use Time Stretch (Slice)**

- Select the sample that you wish to time-stretch using the Slice method.

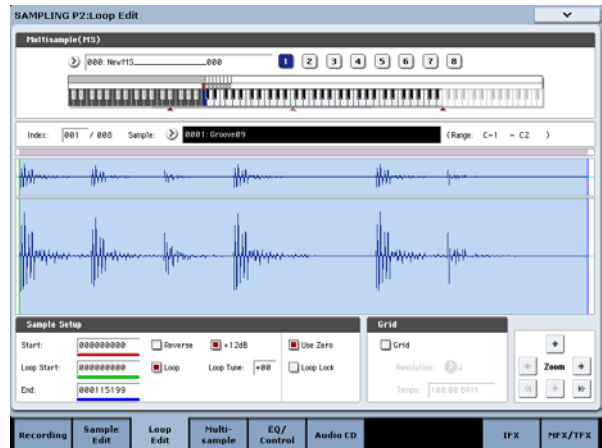

- Select the Time Stretch command from the Page Menu to access this dialog box, where you can select the desired time stretch method.



- Use the radio buttons to select Slice. Then press the OK button to execute, or the Cancel button to cancel without executing.

**[Stereo]** If the L and R of a stereo sample are different in length, blank data will automatically be added to the end of the shorter sample so that it matches the longer side.

- A dialog box for executing Time Stretch will appear.

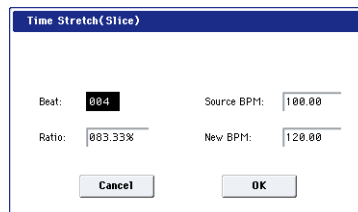

- Specify the number of quarter note beats and tempo of the currently selected sample.

If you already know the BPM value, set **Source BPM**. If you do not know the BPM, setting **Beat** will cause the BPM to be calculated automatically. The settings here are also used as the reference values when detecting the attacks at which the sample is divided.

**Beat:** Specify the number of quarter note beats. When you change **Beat**, the **Source BPM** will indicate the BPM value for playback at the original key. This BPM value is automatically calculated according to the length from the start address to the end address (if loop is off) or from the loop start address to the end address (if loop is on). If you already know the BPM value and the calculated value is incorrect, change **Source BPM** to the correct value.

For example if you have a one-measure 120 BPM sample in 4/4 time, you would set **Beat** to 4. The **Source BPM** will be calculated automatically. If the **Source BPM** is not calculated as 120.00 due to inaccuracies in the start address (or loop start address) or end address, adjust **Source BPM** to the correct value of 120.00.

**Source BPM:** Specify the tempo at the original key of the original waveform.

 **Source BPM** cannot be set or displayed outside the range of 40.00–480.00.

**6. Set the proportional length of the sample that will be created by Time Stretch.**

- To specify the length as a ratio:

Set the **Ratio** to the desired value. The available range is 50.00%–200.00%.

50.00% reduces the sample to half of its original length, doubling the tempo.

200.00% increases the sample to double its original length, slowing the tempo to half-speed.

The tempo of the resulting sample will be calculated automatically based on the **Ratio** and **Source BPM**, and displayed in **New BPM**.

- To match a desired BPM tempo value:

Set **New BPM** to the desired BPM value of the sample that will be created. **Ratio** will automatically be calculated from the **Source BPM** and **New BPM** values.

It is not possible to set or display **New BPM** outside the range of 40.00–480.00. It is not possible to set or display **Ratio** outside the range of 50.00–200.00.

**7. To execute Time Stretch, press the OK button. To cancel without executing, press the Cancel button. When you press the OK button, the attacks will be detected and the sample will be divided automatically, and time stretch will be performed. The Time Stretch dialog box will appear.**

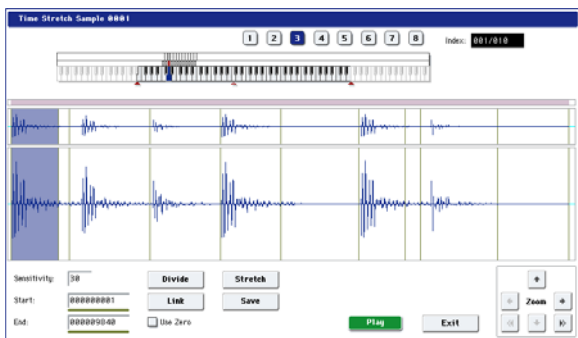

**8. Audition the results that were created by Time Stretch.**

The sample before being time-stretched is assigned to the C2 note of the keyboard. The time-stretched sample is assigned to C#2. Sliced (divided) samples will be assigned consecutively upward, starting from D2 on the keyboard.

**Index**

[Source, Result,

xxx(001...090)/yyy(001...090)]

Selects the index for the sample whose waveform you wish to display.

If you select Source, the original waveform before time-stretching will be selected.

If you select Result, the time-stretched sample will be selected.

If you set this to xxx/yyy, an individually sliced sample will be selected. xxx is the selected index, and yyy indicates the total number of sliced samples. A maximum of 90 samples can be assigned to the keyboard. If the sample was sliced into more than 90 samples, this will be displayed as 90.

You can also select an index by holding down the ENTER switch and playing a note on the keyboard. The index that includes that note will be selected.

 When you execute Time Stretch, the addresses will be specified automatically. However, playback may be slightly offset due to inaccuracies in the end address, etc. If this occurs, set **Index** to Result, and use **Start** and **End** to re-specify the addresses.

**Keyboard & Pads:** This shows the multisample that is temporarily used in this dialog box.

When you play the keyboard, this multisample will sound. It will act in the same way as in normal pages (e.g., the Recording pages). (0–1a)

[Stereo] In the case of a stereo sample, a stereo multisample will be used temporarily. The sample of each index will sound in stereo.

**Sample waveform display:** This displays the waveform of the selected sample. If the **Index** is other than Result, the locations at which the sample is sliced will be indicated by a gray-colored line. If **Index** is set to xxx/yyy, the sample of the selected index will be highlighted. If **Index** is other than xxx/yyy, the Start, Loop Start, and End addresses will be indicated by red, green, and blue colored lines, respectively.

[Stereo] In the case of a stereo sample, the L channel sample data will be displayed above, and the R channel sample data will be displayed below.

**ZOOM:** This lets you zoom the waveform display, in or out, vertically and horizontally.

**9. If the slice locations are not appropriate, use Sensitivity to modify the sensitivity at which the attacks are detected, thus changing the slice locations.**

**Sensitivity**

[00...30]

For information about the **Start**, **End**, **Use Zero**, **Divide**, and **Link** parameters, see “Time Slice” on page 740, steps 6 and 7.

**10. When you press the Stretch button, the Time Stretch dialog box will appear, and you can re-do the time stretch.**

Execute Time Stretch using the same procedure as in step 5. If the sample slice locations are not appropriate, this will also affect the result of Time Stretch. For details on setting the slice locations, see "Time Slice" on page 740, steps 6 and 7.

**11. Save the sample you created. Press the Save button, and the Save dialog box will appear.**

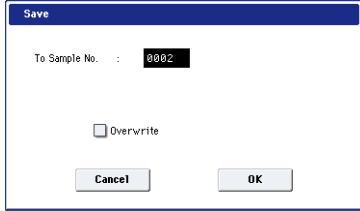

In "To Sample No.," specify the save destination sample number. By default, an unused sample number will be selected. If **Overwrite** is checked, this cannot be set.

If you wish to delete the original sample data and overwrite it with the edited sample, check **Overwrite**.

**!** If you execute this command with **Overwrite** checked, the original sample data will be deleted, and overwritten by the edited sample data. Thus, in the Time Stretch dialog box that appears after execution, the edited sample data will automatically have its attacks detected and sliced, and displayed in **Index Source**.

**[Stereo]** For stereo samples, use "Save to No.(L)" and "(R)" to specify the save-destination of the L and R channels.

To execute the Save, press the OK button. To cancel without executing, press the Cancel button.

**12. By repeating steps 10–11 you can create more samples as desired.**

**13. Press the Exit button to end the Time Stretch operation.**

The last-saved sample number will be set for the index.

*Note:* If you to use the saved sample in Program mode or Sequencer mode, you can use the **Convert MS To Program** menu command, or you can select that multisample for the "2-1c: OSC1 Multisample/Wave Sequence" or "2-5: OSC2 Basic" parameters "MS1"–"M4" (if "Type" = Multisample) and create a program.

**!** Be aware that if you exit **Time Stretch** without using the Save button, and then press the OK button to save the sample, the sample(s) you created will be lost.

**!** Before executing the **Slice** on a long sample, you should first divide the sample into measures. In some cases, it may not be possible to assign the sample to the keyboard or edit the slice locations.

**Time Stretch** requires vacant samples, multisamples, and relative parameters in order to execute. Before you execute, make sure that there is sufficient free space. If there is not, an error will occur.

*Note:* If you open the time slice (Slice) dialog box on the same sample, it will be sliced in the same way it previously was. These slice locations will also be used if you use the **Time Slice** menu command, so that you don't have to make the settings again.

If you wish to detect the attacks again or to re-do the operation, change the **Sensitivity** after you open the dialog box.

**Crossfade Loop**

When looping a pitched instrument sample of a complex sound such as strings or woodwinds to make the sound sustain, it is necessary to create a long loop to preserve the rich character of the sound. **Crossfade Loop** can be used to minimize the difference in sound between the two regions to create a natural-sounding loop.

In order to solve such problems, **Crossfade Loop** causes the sound to change gradually from the end to the beginning of the loop.

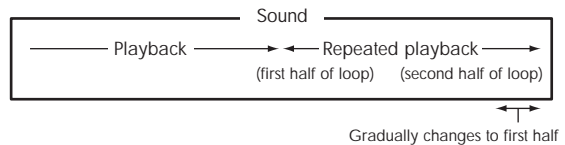

In actuality, the sample data is created as follows.

A specific length (the **Crossfade Length**) of the waveform immediately before the beginning of the loop is taken and mixed with the end portion.

At this time, the waveform level of the portion immediately before the end (the length specified by **Crossfade Length**) will gradually decrease, and the waveform level immediately before the beginning of the loop will gradually increase as the two are mixed.

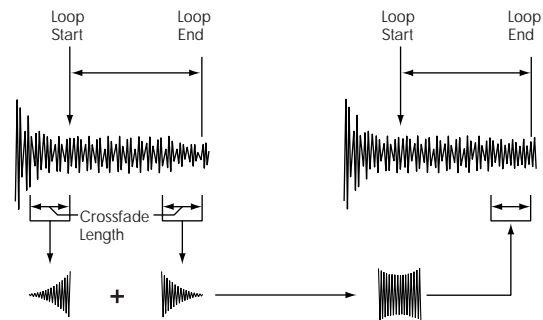

1. Select the sample that you wish to **Crossfade Loop**.
2. Select **Crossfade Loop** to open the dialog box.

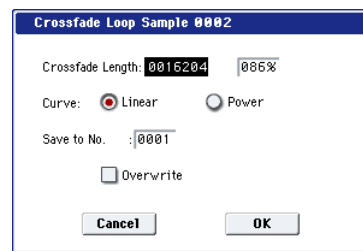

3. In **Crossfade Length**, specify the length of the sample that you wish to crossfade.

If you set this as %, **Crossfade Length** will be calculated automatically. Specify the proportion of the **Crossfade Length** relative to the length between the loop start and loop end. If you set this to 50%, crossfade will be performed on the second half of the region between loop start and loop end.

⚠ If the length from the beginning of the sample to the loop start is shorter than the length from the loop start to the loop end, **Crossfade Length** can be set only up to the length from the beginning of the sample to the loop start. In this case, a setting of 100% will not be possible.

4. Set "Curve" to specify how the volume will change in the crossfaded region.

**Linear:** The volume will change linearly.

**Power:** The volume will change non-linearly. Sometimes a setting of Linear will produce the impression that the volume has dropped in the middle of the curve. In such cases, use Power.

5. In Save to No., specify the save destination sample number. By default, an unused sample number will be selected.

If Overwrite is checked, the sample number will be fixed to the current sample, and cannot be changed. See "About Overwrite" on page 726.

**[Stereo]** For stereo samples, use "Save to No.(L)" and "(R)" to specify the save-destination of the L and R channels.

6. To execute Crossfade Loop, press the OK button. To cancel without executing, press the Cancel button.

## Pitch BPM Adjust

This command sets the **Pitch** (3-1b) of the selected index on the basis of a BPM value. Raising the pitch of sample playback will increase the playback speed. Lowering the pitch will slow down the playback speed. This can be used to match the loop length etc. of the sample to a tempo of the desired BPM value.

1. Select Pitch BPM Adjust to open the dialog box.

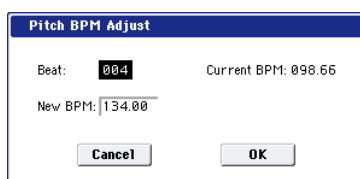

2. Specify Beat. This is specified in quarter-note beats.
3. Current BPM will show the BPM value at the base key (displayed in blue). This BPM value is calculated automatically from the start address to the end address of the sample (if looping is off) or from the loop start address to the end address (if looping is on).

For example if the start and end address of the sample are two seconds apart, the original key is specified as the base key, and **Beat** is set to 4, **Current BPM** would be 120.00. If **Beat** is set to 2, the display would indicate **Current BPM** as 60.00.

⚠ It is not possible for this display to exceed the range of 40.00–480.00.

4. In New BPM specify the BPM value that will result from the conversion of the Current BPM value.
5. To execute the Pitch BPM Adjust command, press the OK button. To cancel, press the Cancel button.

When you execute this command, the **Pitch** (3-1b) value will be set automatically. For example if you modify a quarter-note 120 BPM sample to 240 BPM, the **Pitch** will be set to +12.00.

⚠ This calculation is performed within the KRONOS's limits of precision. Minor discrepancies may occur in the final BPM calculation.

## Destination (Audio CD Ripping)

Specifies the writing data of the ripped data, and executes ripping.

Ripping will create a stereo 44,100 Hz sample. You can rip to RAM memory, or disk. If you select DISK, a WAVE file will be created.

⚠ Be aware that if you play the keyboard or controllers while ripping, the vibration may cause data skips or read errors, making it impossible to rip successfully.

### Ripping to RAM memory

1. Select Destination to open the dialog box.
2. In the To field, select RAM.



3. In "Sample No.(L)" and "Sample No.(R)," specify the destination to which the stereo sample data created by ripping will be written.

By default, the lowest-numbered vacant sample will be displayed. Normally you will leave this default setting unchanged.

4. Press the OK button to execute ripping, or press the Cancel button to cancel without executing.

### Ripping to the disk

1. Select Destination to open the dialog box.
2. In the "To" field, select DISK.

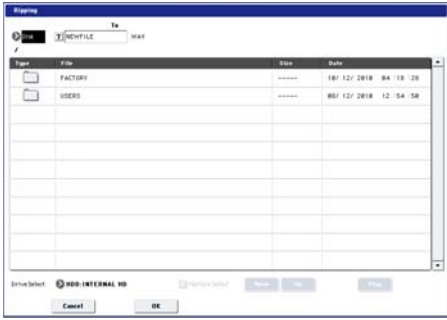

3. Specify a name for the WAVE file that will be saved.
4. In Drive Select, select the disk to which the data will be saved.
5. Use the Open button and Up button to select the save-destination directory.
6. Press the OK button to execute ripping, or press the Cancel button to cancel without executing.

---

### Copy Insert Effect

For more information, please see "Copy Insert Effect" on page 159.

---

### Swap Insert Effect

For more information, please see "Swap Insert Effect" on page 159.

---

### Insert IFX Slot

For more information, please see "Insert IFX Slot" on page 160.

---

### Cut IFX Slot

For more information, please see "Cut IFX Slot" on page 161.

---

### Clean Up IFX Routings

For more information, please see "Clean Up IFX Routings" on page 162.

---

### Copy Master/Total Effect

This copies the effect settings from a desired program, combination, song, or Sampling mode.

For more information, please see "Copy MFX/TFX" on page 162.

---

### Swap Master/Total Effect

For more information, please see "Swap MFX/TFX" on page 163.

---

### Write FX Preset

For more information, please see "Write FX Preset" on page 163.





# Global mode

## Global P0: Basic Setup

In Global mode you can make settings that affect the entire instrument, such as master tuning, MIDI, and memory protect.

You can also edit user scales, Drum Kits, and Wave Sequences.

⚠ If you want settings made in Global mode to persist after the power is turned off, you must write them into memory. To do so, use the menu commands **Write Global Setting**, **Write Drum Kit**, or **Write Wave Sequence**.

You can also press the SEQUENCER REC/WRITE button to call up the **Update Global Setting**, **Update Drum Kit**, or **Update Wave Sequence** commands. These are streamlined versions of the **Write** commands, above.

## 0-1: Basic Setup

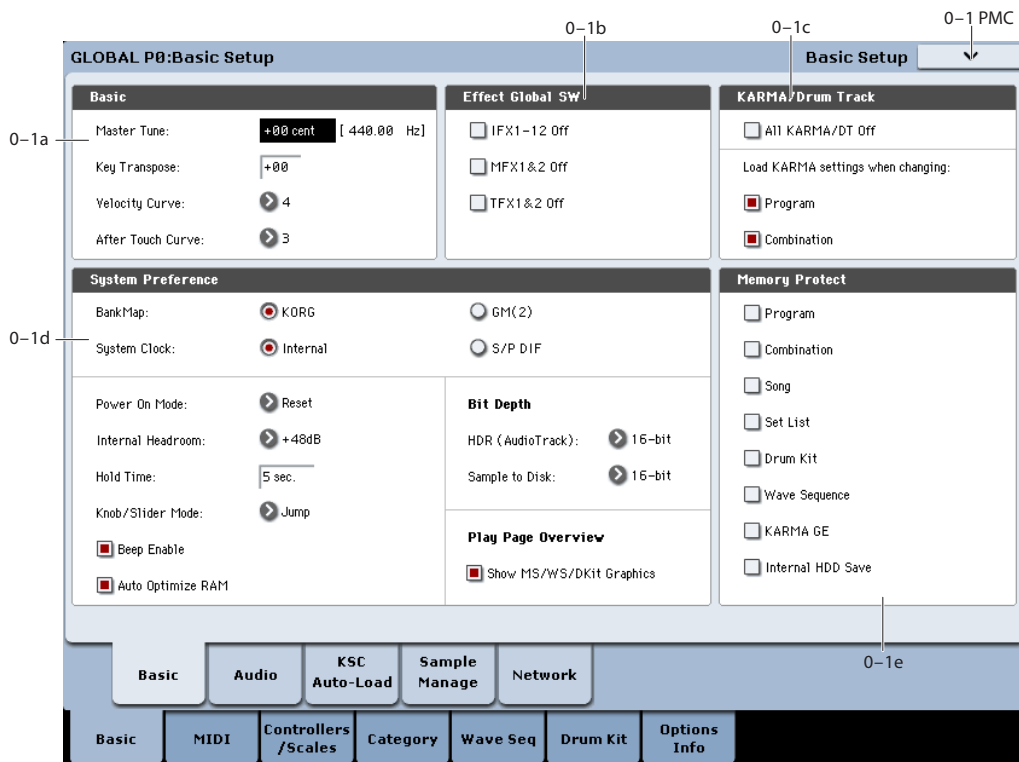

In this page you can adjust the master tuning, turn all effects on/off, make overall system settings such as bank map and system lock, and make memory protect settings.

### 0-1a: Basic

**Master Tune** [-50cent (427.47Hz)... +50cent (452.89Hz)]

This adjusts the overall tuning of the entire KRONOS in one-cent units, over a range of  $\pm 50$  cents. (A cent is 1/100 of a semitone.) At the default of 0, A4 = 440 Hz.

⚠ The value shown for A4's frequency assumes that the scale is set to Equal Temperament. If a different scale is selected, the actual frequency of A4 may be different.

**MIDI** **Master Tune** can be controlled by the MIDI Master Fine Tuning message, on the Global **MIDI Channel**. This is a Universal System Exclusive message, with the format (F0, 7F, nn, 04, 03, vv, mm, F7: nn=MIDI channel, vv/mm= value).

Additionally, MIDI RPN Fine Tune messages can add to and subtract from the pitch specified by **Master Transpose**. In Program mode, this works on the Global **MIDI Channel**; in Combination and Sequencer modes, it can be controlled separately for each MIDI channel. For more information, see "Using RPN (Registered Parameter Numbers)" on page 1136.



**Key Transpose** [-12...+00...+12]

This adjusts the pitch in semitone steps over a ±1 octave range.

*Note:* The way that **Key Transpose** works is affected by the **Convert Position** setting. If **Convert Position** is set to PreMIDI, **Key Transpose** will affect MIDI note numbers transmitted from the KRONOS. For more information, see “Convert Position” on page 772.

Keys/Transpose	-12	0	+12
61 keys	24...84 (C1...C6)	36...96 (C2...C7)	48...108 (C3...C8)
73 keys	16...88 (E0...E6)	28...100 (E1...E7)	40...112 (E2...E8)
88 keys	9...96 (A-1...C7)	21...108 (A0...C8)	33...120 (A1...C9)

**MIDI** **Key Transpose** can be controlled by the MIDI Master Coarse Tuning message, on the Global MIDI Channel. This is a Universal System Exclusive message, with the format (F0, 7F, nn, 04, 04, vv, mm, F7: nn=MIDI channel, vv/mm=value).

Additionally, MIDI RPN Coarse Tune messages can add to and subtract from the pitch specified by **Key Transpose**. In Program mode, this works on the Global MIDI Channel; in Combination and Sequencer modes, it can be controlled separately for each MIDI channel. For more information, see “Using RPN (Registered Parameter Numbers)” on page 1136.

**Velocity Curve** [1...9]

This specifies the way in which the volume and/or tone will change in response to variations in keyboard playing dynamics (velocity). Choose the curve that is most appropriate for your playing strength and style, and the effect that you wish to produce.

When **Convert Position** (1-1a) is PreMIDI, variations in keyboard playing dynamics will affect the velocity effect and the transmitted velocity data as shown in the left-hand diagram below.

Incoming data will automatically use the velocity curve number 4 shown in the right-hand diagram.

With a setting of PostMIDI, variations in keyboard playing dynamics (and in the velocity of incoming data) will respond as shown in the right-hand diagram below. If you are playing KRONOS’s tone generator from an external keyboard or sequencer, and the overall sound is too bright or too dark, you can set the **Convert Position** parameter to PostMIDI and select the appropriate velocity curve here.

For the transmitted data, the velocity curve number 4 shown in the left-hand diagram will automatically be selected.

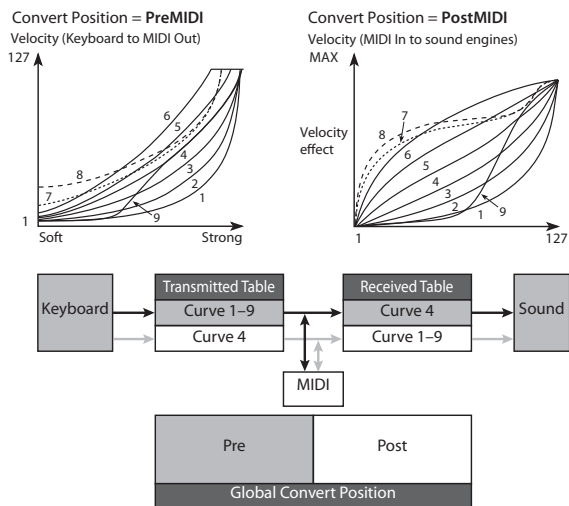

- 1, 2, 3: An effect will be obtained for strongly-played notes
- 4: This is the default curve
- 5, 6: An effect will be obtained even if you do not play very strongly
- 7: A certain amount of effect will be obtained even for softly-played notes
- 8: This curve produces the most regular effect. This setting is suitable when you do not need velocity sensitivity, or when you wish to make the notes more consistent. However with this curve, control of softly-played notes will be more difficult.
- 9: This curve is designed specifically for playing piano sounds from the weighted RH3 keyboards in the 73-note and 88-note models.

**After Touch Curve** [1...8]

This specifies the way in which the volume and/or tone will change in response to variations in pressure (after touch) applied to the keyboard while playing a note.

When **Convert Position** (1-1a) is PreMIDI, variations in after touch pressure will affect the after touch effect and the transmitted after touch data as shown in the left-hand diagram below.

Incoming data will automatically use the after touch curve number 3 shown in the right-hand diagram.

With a setting of PostMIDI, variations in after touch pressure (and in the value of incoming after touch data) will create change as shown in the right-hand diagram.

For the transmitted data, the after touch curve number 3 shown in the left-hand diagram will automatically be selected.

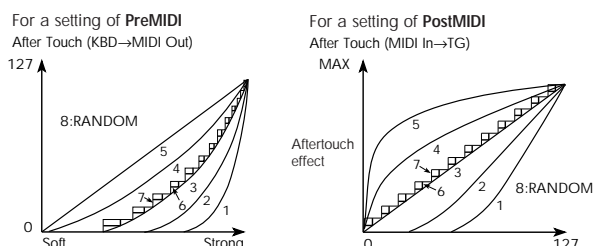

- 1, 2: This curve produces change when strong after touch pressure is applied

**3 (Normal):** The normal curve

**4, 5:** This curve produces change even when light pressure is applied

**6, 7:** These curves produce change in 24 or 12 steps respectively, and are appropriate for when you are recording after touch data on the sequencer and wish to conserve memory. (Set the **Convert Position** to PreMIDI in order to record the results.) Curve number 7 allows change over twelve steps, so when using after touch to modify the pitch, you can set the range of modification to one octave, and use after touch to vary the pitch in semitone steps.

**8:** This is a random curve. Use this when you wish to create special effects, or to use after touch to apply unpredictable modulation.

**MIDI** When **Convert Position** (1-1a) is PreMIDI, the setting you make here will be applied immediately after the keyboard, meaning that it will affect the data transmitted via MIDI, but will not affect the received data.

With a setting of PostMIDI, the setting you make here will be applied immediately before the KRONOS's internal tone generator, meaning that it will affect the data received via MIDI, but will not affect the transmitted data.

When you use the KRONOS's keyboard to play the internal sounds, the **Convert Position** setting has no effect.

## 0-1b: Effect Global SW

**IFX1-12 Off** [Off, On]

**On (checked):** All insert effects IFX1-12 will be off.

**Off (unchecked):** The P8: Insert Effect settings for **IFX1 On/Off-IFX12 On/Off** in Program, Combination, Sequencer, and Sampling modes will be valid.

**MFX1&2 Off** [Off, On]

**On (checked):** Master Effect1 and 2 (MFX1, 2) will be off.

**Off (unchecked):** The P9: Master/Total Effect setting **MFX1 On/Off**, and **MFX2 On/Off**, in Program, Combination, and Sequencer modes will be valid.

**TFX1&2 Off** [Off, On]

**On (checked):** Total effects 1 and 2 (TFX1, 2) will be off.

**Off (unchecked):** The **TFX1 On/Off** and **TFX2 On/Off** settings in the P9: Master/Total Effect page of Program, Combination, Sequencer, or Sampling modes will be used.

**MIDI** When **IFX1-12 On/Off**, **MFX1&2 On/Off**, or **TFX1&2 On/Off** settings are switched, control change messages CC#92 (effect control 2), CC#94 (effect control 4), and CC#95 (effect control 5) will be transmitted respectively. The transmitted data will be 0 for off, and 127 for on.

## 0-1c: KARMA

**All KARMA/DT Off** [Off, On]

**On (checked):** All KARMA and Drum Track functionality will be disabled. KARMA will not play even if the KARMA ON/OFF switch is on; similarly, the Drum Track will not play even if the DRUM TRACK switch is on.

**Off (unchecked):** The KARMA and Drum Track ON/OFF switch settings in Program, Combination, and Sequencer modes will be used.

### Load KARMA settings when changing

**Programs** [Off, On]

**On (checked):** When you switch programs, the KARMA Module settings stored in that program will be used. Normally you will use the On setting.

**Off (unchecked):** The KARMA Module settings will not change even if you switch programs. Use this setting if you want to switch Program sounds without changing the phrases from the KARMA Modules.

**Combinations** [Off, On]

**On (checked):** When you switch Combinations, the KARMA Module settings stored in that Combination will be used. Normally you will use the On setting.

**Off (unchecked):** The KARMA Module settings will not change even if you switch Combinations. Use this setting if you want only to switch the sound of the Combination, without changing the phrases from the KARMA Modules.

## 0-1d: System Preference

**Bank Map** [Korg, GM(2)]

MIDI Bank Select messages work in conjunction with Program Change messages to select Programs and Combinations. Bank Select can work in one of two ways: the standard way ("Korg") or the General MIDI way. Usually, the standard method is preferable. When using General MIDI sequences, however, you may wish to use GM(2) instead.

**MIDI** Bank Select is also used with Set Lists, but they are not affected by the **Bank Map** parameter.

Bank Select uses two MIDI CCs: CC#0 for the upper byte, and CC#32 lower byte.

The table below shows how Bank Select messages are mapped to the internal Program and Combination banks. In some cases, alternate bank numbers are accepted when received via MIDI.

Bank	Bank Map: Korg	Map: GM(2)
INT-A	00.00	63.00
INT-B	00.01	63.01
INT-C	00.02	63.02
INT-D	00.03	63.03
INT-E	00.04	63.04
INT-F	00.05	63.05

Bank	Bank Map: Korg	Map: GM(2)
INT-G,	121.00 (56.00 also accepted)	121.00 (56.00 and 00.00 also accepted)
g(1)...g(9)	121.01...09	
g(d)	120.00 (62.00 also accepted)	
USER-A	00.08	63.08
USER-B	00.09	63.09
USER-C	00.10	63.10
USER-D	00.11	63.11
USER-E	00.12	63.12
USER-F	00.13	63.13
USER-G	00.14	63.14
USER-AA	00.15	63.15
USER-BB	00.16	63.16
USER-CC	00.17	63.17
USER-DD	00.18	63.18
USER-EE	00.19	63.19
USER-FF	00.20	63.20
USER-GG	00.21	63.21

The bank types are as follows.

Bank	Bank Type
INT-A	EXi only
INT-B...F	HD-1 only
INT-G, g(1)...g(9), g(d)	GM2 program banks (HD-1) G: GM2 capital programs g(1)...g(9): GM2 variation programs g(d): GM2 drum programs
USER-A & G USER-EE...GG	Either HD-1 or EXi (default is HD-1)
USER-B...F USER-AA...DD	Either HD-1 or EXi (default is EXi)

To set the type for banks USER-A...G and AA...GG, use the page menu command **Set Program User-Bank Type**.

Bank type is also set automatically when loading banks from disk.

**MIDI** When MIDI System Exclusive messages or program data dumps are received, only data of the same bank type is received. Data of a differing bank type will not be received. Use **Set Program User-Bank Type** to change the bank type before you receive a data dump.

**System Clock** [Internal, S/P DIF]

This sets the digital audio clock source of the KRONOS.

When connecting multiple digital audio devices—such as the KRONOS and a S/P DIF device—it is important that the word clocks of the devices be locked together. If the clocks are not locked, the audio may be marred by pops and clicks.

The KRONOS can lock to incoming clocks from the S/P DIF input, or it can generate its own clock.

**Internal:** The KRONOS will use its own internal clock. This is the default setting.

**S/P DIF:** The KRONOS will use the S/P DIF IN as the master clock.

**MIDI** If **System Clock** is set to S/P DIF but the KRONOS is not detecting a valid clock signal, you'll see the message "Clock Error!" at the top of the display. More importantly, the KRONOS will not sound correctly.

If this occurs, check the following:

- Make sure that the word clock settings of all connected devices are set up correctly, and that there is one and only one device configured to be the word clock master.
- Make sure that the device providing the master clock is powered on.
- Make sure that all cables are undamaged, and are connected properly. If possible, try using different cables.

*Note:* The **System Clock** setting can be stored by the **Write Global Setting** page menu command.

**Power On Mode** [Reset, Memorize]

Specifies the condition at power-on.

**Reset:** The KRONOS will be in Combination mode P0: Play, and Combination INT-A000 will be selected.

**Memorize:** The location (mode and page) where you were when the power was last turned off, and the last-selected program or combination number will be selected.

**MIDI** This function does not memorize the contents of any parameters that were edited. Before turning off the power, be sure to write your data or save it in Disk mode.

**Internal Headroom** [Standard, +12dB, +24dB, +36dB, +48dB]

KRONOS uses 32-bit floating point processing, resulting in an outstanding internal dynamic range of about 1,500dB. This means that internal signals can get both very loud and very soft without any noticeable decrease in audio quality. For instance, you don't need to worry about turning down the oscillator level before entering a highly resonant filter, or be too concerned about maximizing every gain stage.

Audio input and output, on the other hand, uses industry-standard 24-bit fixed-point A/D and D/A converters. As with all such converters, these have a theoretical maximum dynamic range of 144dB, and the loudest level they can produce is referred to as 0dBfs. If they try to produce a louder signal, they will clip at 0dBfs (and sound bad!).

The Internal Headroom parameter helps to control the way in which the internal 1,500dB dynamic range interacts with the audio I/O's theoretical 144dB dynamic range.

To prevent internal signal levels from becoming so high that they completely saturate the D/A converters, the system intentionally limits the maximum signal level at the inputs to IFX1-12, MFX1/2, and TFX1/2.

Internal Headroom sets the volume level at which this limiting happens, relative to the D/A's maximum level of 0dBfs.

**When this is set to Standard**, signals in the FX Busses are limited to the clip point of the D/As. To avoid internal clipping, you can turn down the output of the voice (using EQ Input Trim, for instance), or turn down the inputs or outputs of individual effects.

**When Internal Headroom is set to +12dB, +24dB, +36dB, or +48dB**, the FX Bus signals are allowed to be higher than the maximum D/A levels. This means that there is less chance of clipping internally, so that you don't need to be as concerned about gain-staging between individual effects. However, you still need to make sure that the signal level is 0dBfs or below before reaching the final outputs.

### Knob/Slider Mode [Jump, Catch]

This specifies how the front panel (control surface) MIXER sliders 1-8, master slider, and knobs 1-8 will operate.

When you switch programs, combinations, or songs, the saved or default values will be recalled to the KRONOS's sliders and knobs. In the same way, when you use CONTROL ASSIGN to switch the function of the sliders and knobs, the value of these functions will be recalled and shown. At this time, the actual slider and knob locations may not necessary match the recalled values. The "Knob/Slider Mode" setting specifies the point at which the value will begin changing when you move a slider or knob in such a situation.

#### Example: Switching to a combination in which timbre 01 Volume is set to 64

1. Select a different combination, and press the CONTROL ASSIGN MIXER TIMBRE/TRACK switch to make 1-8 light.

Raise slider 1 to the maximum position, setting timbre 01 **Volume** to 127.

2. Switch to the combination described in the example. In the newly recalled combination, the timbre 01 **Volume** value is 64.

Slider 1 is at the maximum position (127), meaning that the actual value does not match the slider position.

3. The "Knob/Slider Mode" setting **Jump** or **Catch** specifies the point at which the value will begin changing when you move slider 1.

**Jump:** The value will immediately change to the controller location as soon as you move the control surface controller.

In the above example, the value will respond immediately when you move slider 1 slightly below 127 (for example, to 125). The disadvantage of this setting is that the value will jump abruptly to the new value, potentially causing a sudden change in the audio. The advantage is that the value will respond immediately when you move the controller.

**Catch:** The value will begin changing only when you have moved the controller surface controller to the position that matches the current value.

In the above example, the **Volume** will not immediately change from the current value of 64 when you begin lowering slider 1. As you lower slider 1 through 127 → 64 → 0, the value will change 64 → 64 → 0. In other words, the value will begin responding only after you Catch it. This setting can be advantageous when you want to adjust the volume smoothly without causing abrupt jumps. However the disadvantage is that the controller will not respond until you have caught the value.

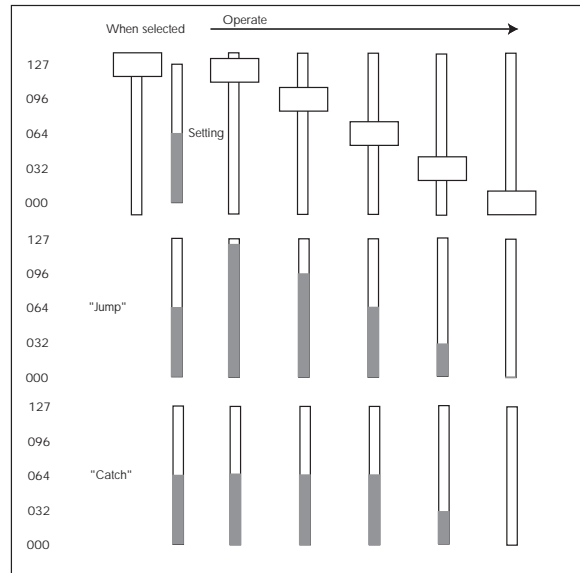

### Beep Enable [Off, On]

**On (checked):** A beep will be heard when you press an object in the LCD screen.

### Auto Optimize RAM [Off, On]

When sampling to RAM, this controls whether or not the sample memory (RAM) will be optimized after data is written.

Optimization rearranges any unused memory areas so that all of the remaining memory can be used.

**On (checked):** RAM will automatically be optimized when sampling ends.

With this setting, you will always be able to sample without wasting RAM, but the sound will stop when sampling ends. If a song was playing in Sequencer mode, the playback will stop.

**Off (unchecked):** RAM will not be optimized when sampling ends. Since the sound will not stop when sampling ends, this setting is convenient when you want to consecutively sample several sections while a song plays or while listening to an input source such as a CD.

If **Auto Optimize RAM** is Off and unused areas have accumulated in memory, you can use the **Optimize RAM** menu command to perform the same function manually. For more information, see "Optimize RAM" on page 148.

The remaining amount of sample memory can be checked in Sampling mode. For more information, see "0-1f: Free Sample Memory/Locations" on page 684.

## Bit Depth

### HDR (Audio Track) [16-bit, 24-bit]

This sets the bit depth for newly recorded audio tracks. It does not alter previously recorded tracks.

24-bit files offer higher fidelity, but take up 50% more space on disk.

### Sample to Disk [16-bit, 24-bit]

This sets the bit depth for sampling to disk. Note that this does not affect sampling to RAM. This same parameter appears on the sampling setup pages in Program, Combination, Sequencer, and Sampling modes; changes in one place are reflected everywhere.

The resulting 24-bit files can be used at full resolution in audio tracks. When loaded into RAM, they are automatically converted to 16-bit data.

## Play Page Overview

### Show MS/WS/DKit Graphics [Off, On]

HD-1 Programs can show a graphic on the P0:Play page, instead of the Multisample, Wave Sequence, or Drum Kit names. Each Program controls which graphics to show, or whether to show the names instead. For more information, see “1-1h: Play Page MS/WS/DKit Display” on page 41.

This parameter provides a global override for the per-Program settings, if you’d prefer to always see the names rather than the graphics. It mirrors the Program menu item “Show MS/WS/DKit Graphics” on page 148. Changes to this parameter are reflected in the menu item, and vice-versa.

**On (checked):** Graphics will be shown or not, according to the Program’s settings.

**Off (unchecked):** Regardless of the Program’s settings, the Multisample, Wave Sequence, or Drum Kit names will be shown.

---

## 0-1e: Memory Protect

### Program [Off, On]

This setting protects the internal program memory.

**On (checked):** Internal program memory will be protected, and the following write operations cannot be performed.

- Writing a program
- Loading program data from disk
- Receiving program data via MIDI data dump

**Off (unchecked):** Data can be written to internal program memory.

### Combination [Off, On]

This setting protects the internal combination memory.

**On (checked):** Internal combination memory will be protected, and the following write operations cannot be performed.

- Writing a combination
- Loading combination data from disk
- Receiving combination data via MIDI data dump

**Off (unchecked):** Data can be written to internal combination memory.

### Song [Off, On]

This setting protects the internal song memory.

However, when the power is turned off, the song data in song memory will be lost regardless of this setting.

**On (checked):** Internal song memory will be protected, and the following write operations cannot be performed.

- Recording to the sequencer
- Loading song data from disk
- Receiving song data via MIDI data dump

**Off (unchecked):** Data can be written to internal song memory.

### Drum Kit [Off, On]

This setting protects the internal drum kit memory.

**On (checked):** Internal drum kit memory will be protected, and the following write operations cannot be performed.

- Writing a drum kit
- Loading drum kit data from disk
- Receiving drum kit data via MIDI data dump

**Off (unchecked):** Data can be written to internal drum kit memory.

### Wave Sequence [Off, On]

This setting protects the internal wave sequence memory.

**On (checked):** The internal wave sequence memory will be protected, and the following operations will not be possible.

- Writing a wave sequence
- Loading wave sequence data from disk
- Receiving wave sequence data via MIDI data dump

**Off (unchecked):** You will be able to write to internal wave sequence memory.

### KARMA GE [Off, On]

This setting protects the internal KARMA GE memory.

**On (checked):** The internal KARMA GE memory will be protected, and the following operations will not be possible.

- Loading KARMA GE data from disk
- Receiving KARMA GE data via MIDI data dump

**Off (unchecked):** You will be able to write to internal KARMA GE memory.

### Internal HDD Save [Off, On]

This setting protects the internal hard disk.

**On (checked):** The internal hard disk will be protected, and the following operations will not be possible.

- Saving, copying, or deleting internal hard disk data in Disk mode
- Recording audio tracks in Sequencer mode
- Sampling to DISK in each mode



- Ripping audio CDs in Sampling mode

**Off (unchecked):** You will be able to write data to the internal hard disk.

## ▼ 0-1: Page Menu Commands

The number before each command shows its ENTER + number-key shortcut. For more information on these shortcuts, see “ENTER + 0-9: shortcuts for menu commands” on page 147.

- **0: Write Global Setting.** For more information, see “Write Global Setting” on page 806.
- **1: Set Program User-Bank Type.** For more information, see “Set Program User-Bank Type” on page 806.
- **2: Change all bank references.** For more information, see “Change all bank references” on page 807.
- **3: Touch Panel Calibration.** For more information, see “Touch Panel Calibration” on page 807.
- **4: Half Damper Calibration.** For more information, see “Half Damper Calibration” on page 807.
- **5: After Touch Calibration.** For more information, see “After Touch Calibration” on page 808.
- **6: LCD Setup.** For more information, see “LCD Setup” on page 808.
- **7: Update System Software.** For more information, see “Update System Software” on page 808.
- **8: Display Public ID.** For more information, see “Display Public ID” on page 809.

## 0-2: Audio Input

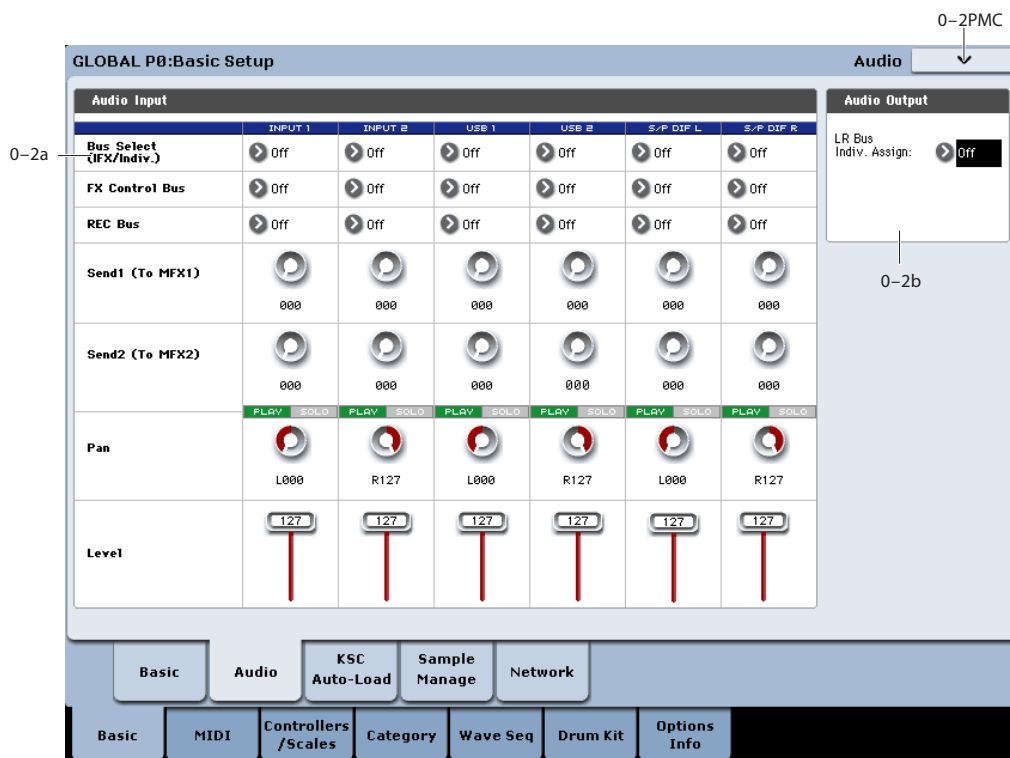

This page controls the default mixer settings for the audio inputs, including level, pan, effects bussing, and so on. It also lets you route the main L/R outputs to a pair of individual outputs, for specific applications in live performance and recording.

### 0-2a: Audio Input

Each Program, Combination, and Song can either use these Global audio input mixer settings, or have its own custom settings. This is controlled by the **Use Global Settings** parameter, on the Program, Combination, or Song’s Audio Input/Sampling page.

The default for **Use Global Settings** is **On**. This lets you change freely between different Programs, Combis, and Songs without affecting the audio inputs.

Also, any edits made in the mode’s Audio Input/Sampling page will affect the Global setting, and vice-versa.

On the other hand, it may sometimes be convenient to save a particular mixer setup with an individual Program, Combi, or Song, to set up special sub-mixer settings or effects processing for particular inputs. For example, you can set up a Program to use a mic input with a vocoder, as described under “Vocoder (Program mode)” on page 861.

In this case, set the Program, Combi, or Song’s **Use/Edit Global Setup** to **Off**, and the audio inputs will use the custom settings.

With this in mind, the Global settings apply in the following situations:

- When this page (Global Audio Input) is open.

- In Program, Combination, and Sequencer modes, if the Audio Input/Sampling page's **Use Global Setting** check-box is **On**. This can be set independently for each Program, Combination, and Song.
- In other pages of Global mode, if you switch to Global mode from a Program, Combi, or Song with **Use Global Setting** set to **On**.
- Similarly, in Disk mode, if you switch to Disk mode from a Program, Combi, or Song with **Use Global Setting** set to **On**.

**Input1, Input2**

These are the settings for audio inputs 1 and 2.

**S/P DIF L, S/P DIF R**

These are the settings for the S/P DIF input.

**MIDI** When using the S/P DIF inputs, make sure that the **System Clock** parameter is set appropriately. For more information, see "System Clock" on page 756.

**Bus Select (IFX/Indiv.) [L/R, IFX1...12, 1...4, 1/2...3/4, Off]**

This specifies the main bus routing for the input signal.

**L/R:** The input signal will be sent to the L/R bus.

**IFX1...12:** The input signal will be sent to the IFX1–12 bus. Choose one of these settings if you want to apply an insert effect while sampling.

**1...4:** The input signal will be sent to the specified **INDIVIDUAL OUTPUT** in mono. The **Pan** setting will be ignored.

**1/2...3/4:** The input signal will be sent in stereo (including the effect of the **Pan** control) to the specified **INDIVIDUAL OUTPUT** pair.

**Off:** The input signal will not be routed directly to the outputs or Insert Effects. However, it may still be routed to an FX Control Bus or REC Bus.

**FX Ctrl Bus (FX Control Bus) [Off, 1, 2]**

This sends the external audio input signal to an FX Control bus (two stereo channels; FX Ctrl 1 and 2).

For details, see "8–1d: FX Control Bus" on page 135.

**REC Bus [Off, 1, 2, 3, 4, 1/2, 3/4]**

This sends the external audio input signal to the REC buses (four mono channels; 1, 2, 3, 4).

Use the REC buses when you want to sample in various modes or to record audio tracks in Sequencer mode. These are dedicated buses for recording.

**Off:** The external audio signal will not be sent to the REC buses. Normally you will use the Off setting.

**1, 2, 3, 4:** The external audio input signal will be sent to the specified REC bus. The **Pan** setting is ignored, and the signal is sent in monaural.

**1/2, 3/4:** The external audio input signal will be sent in stereo to the specified pair of REC buses. The **Pan** setting sends the signal in stereo to buses 1 and 2 or buses 3 and 4.

**Send1 (to MFX1) [000...127]**

**Send2 (to MFX2) [000...127]**

These adjust the levels at which the audio input is sent to the master effects.

**Send1 (to MFX1):** Send the signal to master effect 1.

**Send2 (to MFX2):** Send the signal to master effect 2.

This setting is ignored if **Bus Select** is other than L/R or Off.

If **Bus Select (IFX/Indiv.)** is set to IFX1–12, the send levels to the master effects are set by the post-IFX1–12 **Send1** and **Send2** (Program, Combination, Sequencer 8–5a).

*Note:* You can use the control surface to control Send1 (to MFX1) and Send2 (to MFX2). You can also make this setting from the front panel mixer section or from the P0– Control Surface screen of the LCD.

**PLAY/MUTE [(Off, On)]**

This indicates the PLAY or MUTE status of each audio input. The settings can be switched from the control surface.

**PLAY:** The external audio signal will be input as specified by the various parameters.

**MUTE:** The external audio signal will be muted (silent), and will not be input.

*Note:* You can control PLAY/MUTE from the control surface. You can also make this setting from the front panel mixer section or from the P0– Control Surface page of the LCD.

**SOLO ON/OFF**

Solo lets you isolate one or more Oscillators, Timbres, Tracks, or Audio Inputs, so that you hear them by themselves. It does this by temporarily muting all non-soloed channels.

In Global mode, the way in which Solo operates depends on the setting of the **Exclusive Solo** menu command in the previously selected mode. For more information, see "Exclusive Solo menu parameter" on page 24.

**Exclusive Solo Off:** Multiple channels can be soloed. The solo status will change each time you press SOLO ON/OFF.

**Exclusive Solo On:** When you press SOLO ON/OFF, only that channel will be soloed.

*Tip:* You can use the control surface MIX SELECT 1–6 switches to control this parameter. For more information, see "Using the control surface with the Audio Inputs" on page 14.

**MIDI** The SOLO setting is not saved when you Write.

**Pan [L000...C064...R127]**

This specifies the panning of the external audio input signal. With a stereo audio source, you will normally set the inputs to L000 and R127 respectively.

*Note:* You can also control Pan from the control surface.

**Level [000...127]**

Specifies the level of the external audio signal. Normally you will set this at 127.



*Note:* You can also control volume from the control surface.

**Avoiding distortion**

The analog signal from AUDIO INPUTS 1 & 2 is converted to a digital signal by an A/D converter. The **Level** parameter sets the volume immediately after the conversion into digital form.

Because of this, it’s best to optimize the analog signal level first, and then make fine adjustments via the **Level** parameter if necessary. You can control the analog level by adjusting the rear-panel AUDIO INPUT MIC/LINE switches and LEVEL knobs, or the output level of the external audio source.

This also means that if the sound is distorting because the analog signal is too loud, adjusting the **Level** setting won’t help. If you hear unwanted distortion, try adjusting the analog levels as described above.

**Avoiding extraneous noise**

If cables are connected to AUDIO INPUTS 1 & 2, any noise carried by the cables will enter into the KRONOS mixer structure. Similarly, the S/P DIF input may carry noise from external devices. This may include hiss, hum, and other audio noise.

To avoid noise from unused audio inputs, either:

- Set the input’s **Level** to 0
- or
- Set all of the bus assignments to Off, including **Bus Select (IFX/Indiv. Out Assign)**, **REC Bus**, and **FX Control Bus**

If no audio cables are connected to the inputs, the signals are forced to zero, preventing any additional noise.

**0–2b: Audio Output**

**L/R Bus Indiv. Assign** [Off, 1/2, 3/4]

This lets you send the L/R output to any pair of individual outputs, in addition to all of the normal L/R outputs (including the main L/R outputs, the HEADPHONE jack, and the S/P DIF and USB outputs).

In studio or live performance situations, you can use this parameter to monitor sounds in privacy, without changes at the main board.

**Off:** The L/R output will be sent to the normal outputs only (as described above).

**1/2, 3/4:** The L/R output will be sent to the corresponding pair of INDIVIDUAL OUT 1–4 jacks, as well as to all of the normal outputs.

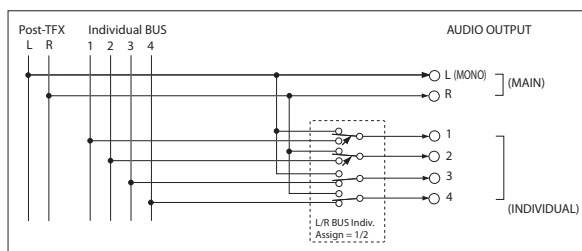

**Private monitoring**

On stage, or in the studio, it can be convenient to audition sounds or make edits without sending the signal to the mixer, or to the main monitors. You can use **L/R Bus Indiv. Assign** to do this:

1. **Connect Individual Outputs 1/2 to the mixer or main monitors. Do not connect the main L/R outputs.**
2. **While you’re auditioning sounds or editing, set L/R Bus Indiv. Assign to Off.**
3. **Use the built-in headphone output for listening to KRONOS as you select or edit sounds.**

You can actually use either of the individual output pairs, but we’ll talk about 1/2 in this example.

2. **While you’re auditioning sounds or editing, set L/R Bus Indiv. Assign to Off.**
3. **Use the built-in headphone output for listening to KRONOS as you select or edit sounds.**

As an alternative, you can connect the main L/R outputs to your personal monitor mixer.

4. **When you’re ready for others to hear the results, set L/R Bus Indiv. Assign to 1/2.**

Now, the KRONOS stereo mix will go to the main board.

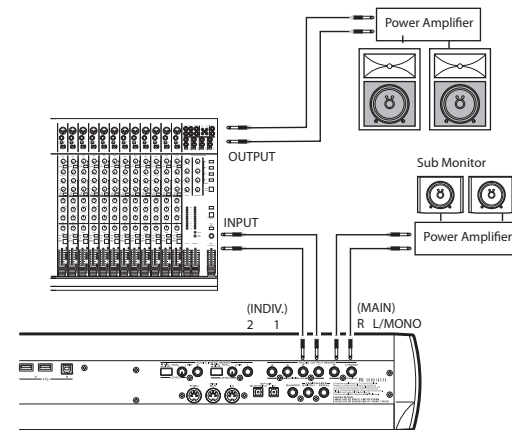

**▼ 0–2: Page Menu Commands**

The number before each command shows its ENTER + number-key shortcut. For more information on these shortcuts, see “ENTER + 0-9: shortcuts for menu commands” on page 147.

- **0: Write Global Setting.** For more information, see “Write Global Setting” on page 806.
- **1: Set Program User-Bank Type.** For more information, see “Set Program User-Bank Type” on page 806.
- **2: Change all bank references.** For more information, see “Change all bank references” on page 807.
- **3: Touch Panel Calibration.** For more information, see “Touch Panel Calibration” on page 807.
- **4: Half Damper Calibration.** For more information, see “Half Damper Calibration” on page 807.
- **5: After Touch Calibration.** For more information, see “After Touch Calibration” on page 808.
- **6: LCD Setup.** For more information, see “LCD Setup” on page 808.
- **7: Update System Software.** For more information, see “Update System Software” on page 808.

- 8: **Display Public ID.** For more information, see “Display Public ID” on page 809.

## 0-3: KSC Auto-Load

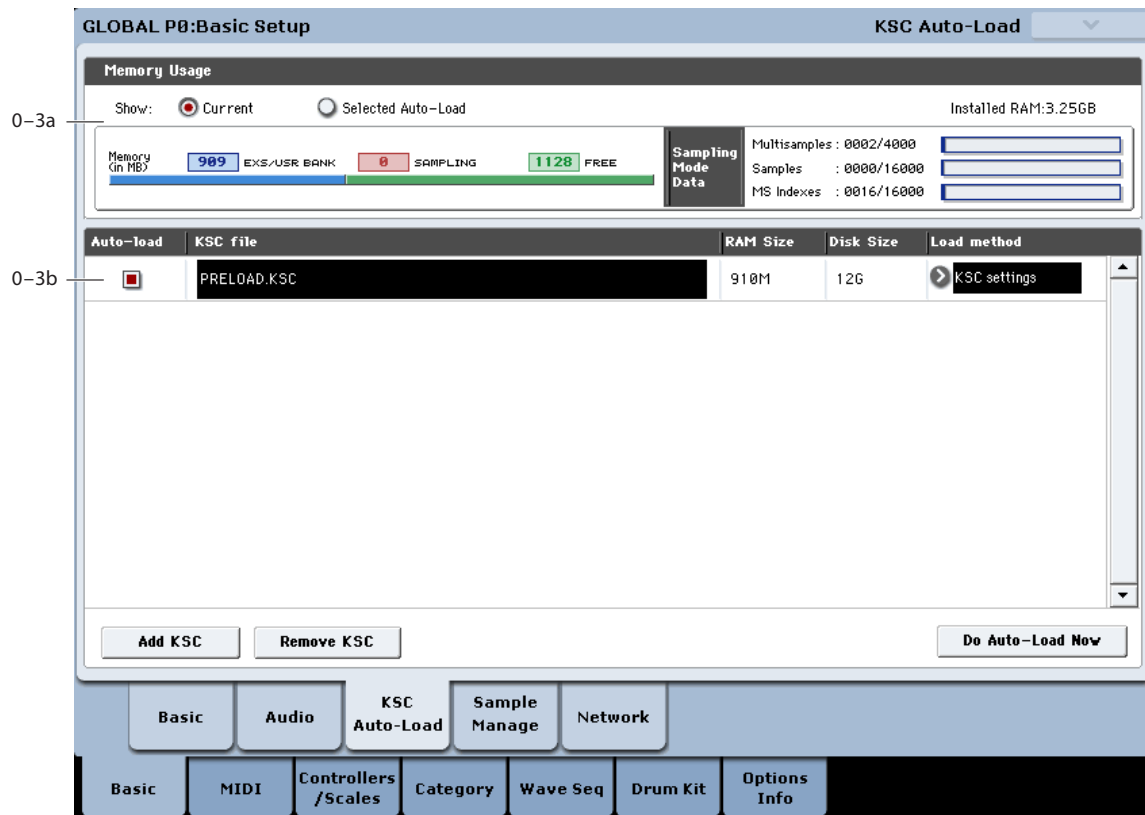

### Overview

KSC stands for Korg Sample Collection. KSC files contain links to RAM and/or EXs sample data, including Multisamples, Samples, and Drum Samples. Loading a KSC file loads all of the linked sample data.

At startup, the KRONOS can automatically load one or more KSC files. This page lets you select which KSC files are loaded. These settings are saved automatically, and are not part of the Global PCG file.

#### Adding a KSC to the list

To add a KSC to the list:

1. Press the **Add KSC** button.

The Add KSC dialog appears, allowing you to select KSC files from disk. For details, see “Add KSC” on page 764.

2. Select the desired KSC files.
3. Press **OK**.

The selected KSC files will be added to the list.

#### Removing a KSC from the list

To remove a KSC from the list:

1. Select the KSC file that you’d like to remove.
2. Press the **Remove KSC** button.

A confirmation dialog appears:

Are you sure?  
[Cancel] [OK]

3. Press **OK**.

The KSC file will be removed from the list.

- ⚠ Do not turn off the power for at least 10 seconds after adding or removing KSCs, or making any other changes to the auto-load settings. This allows the system time to complete the process, which includes saving the settings to the internal disk.

#### Applying changes immediately

Normally, changes only take affect after the next restart. To load and un-load KSCs immediately:

1. Press the **Do auto-load now** button.

A confirmation dialog appears. For details, see “Do auto-load now” on page 764.

2. Press **OK**.

Any changes you’ve made by adding or removing KSC files will be applied, with sample data loaded and un-loaded as necessary. Note that this may take some time to complete.

### 0-3a: Memory Usage

This shows the amount of memory used by the different types of samples, along with the slots used for Sampling Mode Multisamples, Samples, and Multisample Indexes (key zones within Multisamples).

#### Show [Current, Selected Auto-Load]

This selects whether the graphic shows the current state of memory, or the state of memory as it would be after doing an auto-load using the current settings.

It's possible for different KSC files to refer to the same sample data; for instance, two KSC files may point to the same set of Grand Piano multisamples. In this case, the redundant data is counted only once.

#### EXS/USR BANK

This shows the amount of memory used for EXs and User Sample Banks.

#### SAMPLING MODE

This shows the amount of memory used for data in Sampling Mode.

#### Free

This shows the amount of memory still available.

#### Sampling Mode Data

##### Multisamples [nnnn/4,000]

This shows the number of Multisamples in Sampling Mode, out of the maximum of 4,000.

##### Samples [nnnn/16,000]

This shows the number of Samples in Sampling Mode, out of the maximum of 16,000.

##### MS Indexes [nnnn/16,000]

This shows the total number of Indexes in all Multisamples in Sampling Mode, out of the maximum of 16,000.

#### Over indications

There are various indications if the selected data exceeds any of the following.

##### Memory capacity exceeded

If the size of the sample data in MB adds up to greater than the total available memory, then there are several indications in the graphic:

- The **Free** box turns red, and shows the amount by which the selected data exceeds the available memory, as a negative number
- The word **OVER** appears in red to the right of the Free box, with three exclamation points on a second line

##### Max numbers exceeded for Sampling Mode Multisamples, Samples, or indexes

Sampling Mode can have up to 4,000 Multisamples, 16,000 Samples, and 16,000 indexes in Multisamples. If any of these limits would be exceeded by the selected auto-load, then there are two indications in the graphic:

These maximums apply only to Sampling Mode; ROM, EXs, and User Sample Banks do not count towards these totals.

- The numbers for the affected data type (e.g., number of Sampling Mode Samples) are shown in red
- The bar-graph for the data type turns red, instead of blue, and extends to fill the entire length

### 0-3b: List of KSCs

This list shows the KSCs available for auto-loading. To add or remove KSC files from this list, use the **Add KSC** and **Remove KSC** buttons below the list; for more information, see "Add KSC" on page 764 and "Remove KSC" on page 764. Each KSC in the list has several parameters, as detailed below.

If a KSC is loaded in disk mode, it is automatically added to the list on a temporary basis. If you then check the KSC's **Load** check-box, the KSC is added to the list just as if it had been added by using **Add KSC**. If you do not check **Auto-load**, any automatically-added KSCs are cleared from the list at the next startup.

The list of KSCs is organized alphabetically.

#### Auto-load [Check-box]

If this box is checked, the KSC will be auto-loaded. If it is un-checked, the KSC remains in the list, but is not auto-loaded.

You can keep frequently-used KSC files in the list for easy access, and enable and disable their **Auto-load** check-boxes as desired.

#### KSC file [File name]

This is the name of the KSC file.

#### RAM size [Size in MB]

This shows the size that the KSC will use when loaded, according to the selected **Load method**.

#### Disk size [Size in MB]

This shows the size of the KSC on disk.

#### Load method [RAM, Virtual Memory, KSC settings]

The **Load Method** sets the preferred way to load the KSC's samples: load them entirely into RAM, or use Virtual Memory.

Note that if the data is extremely large, and would not fit into RAM regardless of which other samples were loaded, the data will use Virtual Memory regardless of this setting.

These settings apply only to EXs and User Sample Bank data; Sampling Mode data is always loaded into RAM.

**RAM:** The samples will be loaded into RAM. This has the advantage of allowing reverse sample playback.

**Virtual Memory:** The samples will use Virtual Memory. This generally allows you to load more large samples at once. Note that the samples may still require a significant amount of RAM.

**KSC Settings:** KSCs can store separate load method settings for each Multisample or Drum Sample, based on the settings when the KSC was saved. Setting **Load method** to **KSC Settings** uses these individual settings.

---

### Add KSC

Pressing this button brings up a file browser, similar to the popup file browser for setting the sample-to-disk location. There are two buttons below the standard file browser controls: **Cancel** and **Add**.

To add files, select one or more KSC files (you can use Multiple select to choose more than one file) and press **Add**. To exit without making any changes, press **Cancel**.

When KSCs are added to the list, their **Auto-load** check-boxes are set to On.

See also "Adding a KSC to the list" on page 762.

---

### Remove KSC

This button lets you remove KSCs from the list. It only affects the contents of the list; it does not affect the files themselves.

When you press the **Remove KSC** button, a confirmation dialog appears:

Are you sure?

[Cancel] [OK]

Press **OK** to remove the KSC from the list, or **Cancel** to exit without making any changes.

See also "Removing a KSC from the list" on page 762.

---

### Do auto-load now

Pressing this button brings up a confirmation dialog:

This will erase all EXs and RAM samples, and then load the selected KSC files.

Are you sure that you want to proceed?

[Cancel] [OK]

If you press **OK**, the system clears all RAM and EXs sample data, and then goes through the auto-load process immediately. Note that this may take time to complete.

The **Do auto-load now** button is grayed out if the selected samples exceed the maximum available RAM, # of MS, # of Samples, or # of MS Indexes.

See also "Applying changes immediately" on page 762.

---

### ▼ Page Menu commands

No menu commands are available on this page.

## 0-4: Sample Management

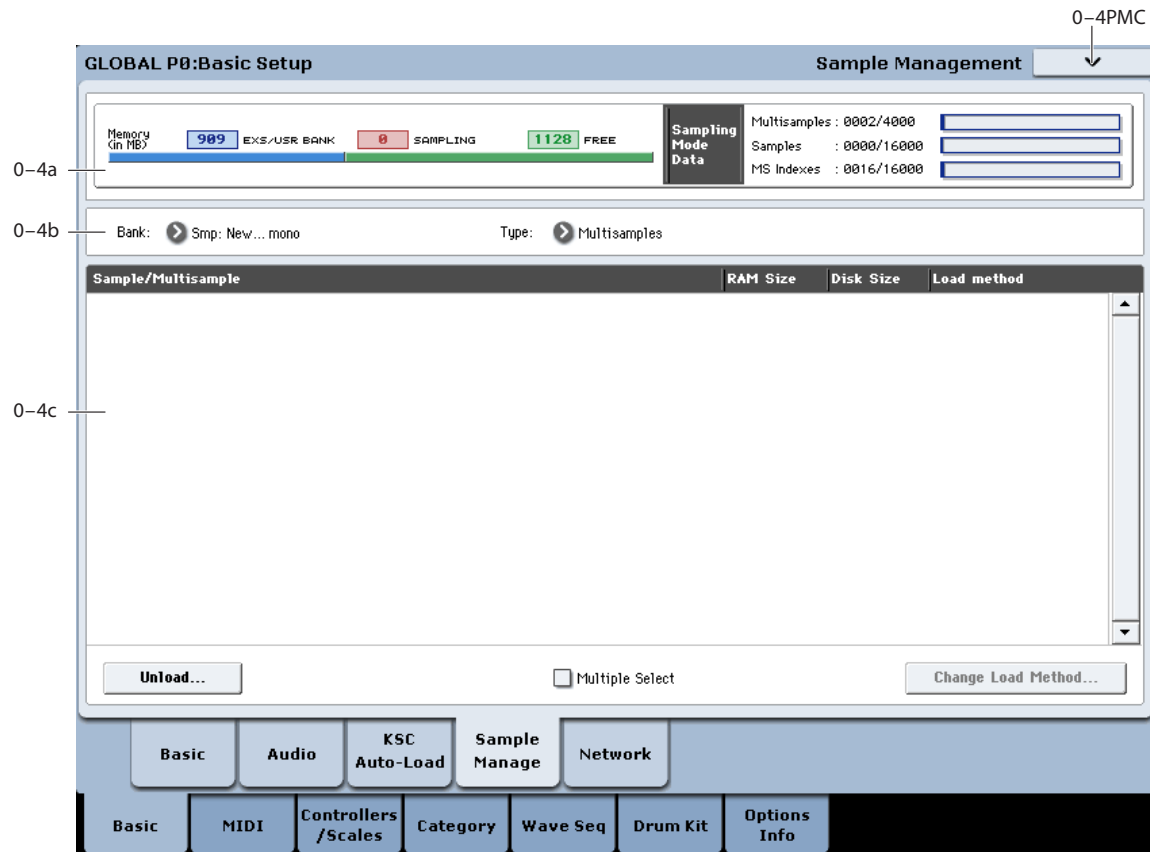

### Overview

This page offers tools for managing all the loaded sample data, including Sampling Mode, EXs, and User Sample Banks. You can:

- See an overview of memory usage
- See the loaded Multisamples, Samples, or Drum Samples for each bank
- View and change the load method (RAM or Virtual Memory) for each item in EXs and User Sample Banks
- Unload items from memory

### 0-4a: Memory Usage

This shows an overview of sample-related memory usage. For details, see “0-3a: Memory Usage” on page 763.

### 0-4b: Bank and Type select

**Bank** [Smp Mono, Smp Stereo, EXs1 Mono...EXs(n) Stereo, User Sample Banks]

This selects the bank to display in the list. Only banks which are loaded in whole or in part are shown.

### Type

[Multisamples, Samples]

This selects the type of data which will be displayed in the list. With EXs and User Sample Banks, **Samples** are equivalent to **Drum Samples**.

### 0-4c: Sample/Multisample

This list shows the Multisamples, Samples, or Drum Samples of the selected Bank, according to the Bank and Type selections above.

You can select individual items from the list, and then use the **Unload** or **Change load method** buttons to affect the selected items.

To select two or more items at once, enable the **Multiple Select** check-box below the list.

To select all of the items at once, use the **Select all** command in the menu.

### Unload

This button lets you remove the selected items from memory. This does not affect the data stored on disk; it only changes what is currently loaded into memory.

### Unloading individual items

To unload individual Multisamples, Drum Samples, or Samples:

1. Above the list, select the desired **Bank** and **Type**.

For EXs and User Sample Banks, the possible Types are Multisample or Drum Sample. For Sampling Mode, the possible Types are Multisample or Sample.

**2. Select the desired items (Multisamples or Samples) from the list.**

To select two or more items at once, enable the **Multiple Select** check-box.

**3. Press the Unload button.**

A confirmation dialog will appear.

**4. Press the OK button to confirm, or Cancel to exit the dialog without making changes.**

Sample data may be shared by two or more Multisamples or Drum Samples. If a Sample is used only by the Multisample or Drum Sample being unloaded, the Sample will be unloaded as well. If the Sample is used elsewhere, it will stay loaded.

### Unloading an entire bank of data

You can also un-load an entire bank of data at once. To do so:

**1. In the menu, select the Unload all in bank command.**

The **Unload all data from selected bank** dialog will appear.

**2. Select the desired bank (Sampling Mode, or any EXs or User Sample Bank).**

**3. Press the OK button to confirm, or Cancel to exit the dialog without making changes.**

### Unloading half of a stereo sound

Stereo Samples and Multisamples are made up of two linked items, one for the left channel and the other for the right channel, with names ending in -L and -R respectively. The left and right channels also may be used individually as mono sounds.

If either the left or right channel is unloaded, the item is removed from the list of stereo Samples or Multisamples. However, the remaining channel is still available as a mono sound.

---

## Change load method

This button lets you change how the currently selected sample data is loaded, using either RAM or Virtual Memory. Note that this has no effect on the data stored on disk.

If all of the selected samples are too large to fit into RAM, then the **Load Method** combo box will be grayed out, and the value will be set to **Virtual Memory**.

This applies only to data in EXs and User Sample Banks; it does not apply to Sampling Mode.

### Load method [No Change, RAM, Virtual Memory]

**No Change:** this is the default. The load method of the sample data will remain as it was before.

**RAM:** The sample data will be loaded into RAM.

**Virtual Memory:** The sample data will be loaded using Virtual Memory.

---

## ▼ 0-4: Page menu commands

- **0: Select all.** This command selects all of the items in the list.
- **1: Unload all in bank.** This removes the entire selected bank from memory. For more information, see “Unloading an entire bank of data,” above, and “Unload all in bank” on page 814.
- **2: Remap MS/Sample Banks.** For more information, see “Remap MS/Sample Banks” on page 163.

## 0-5: Network

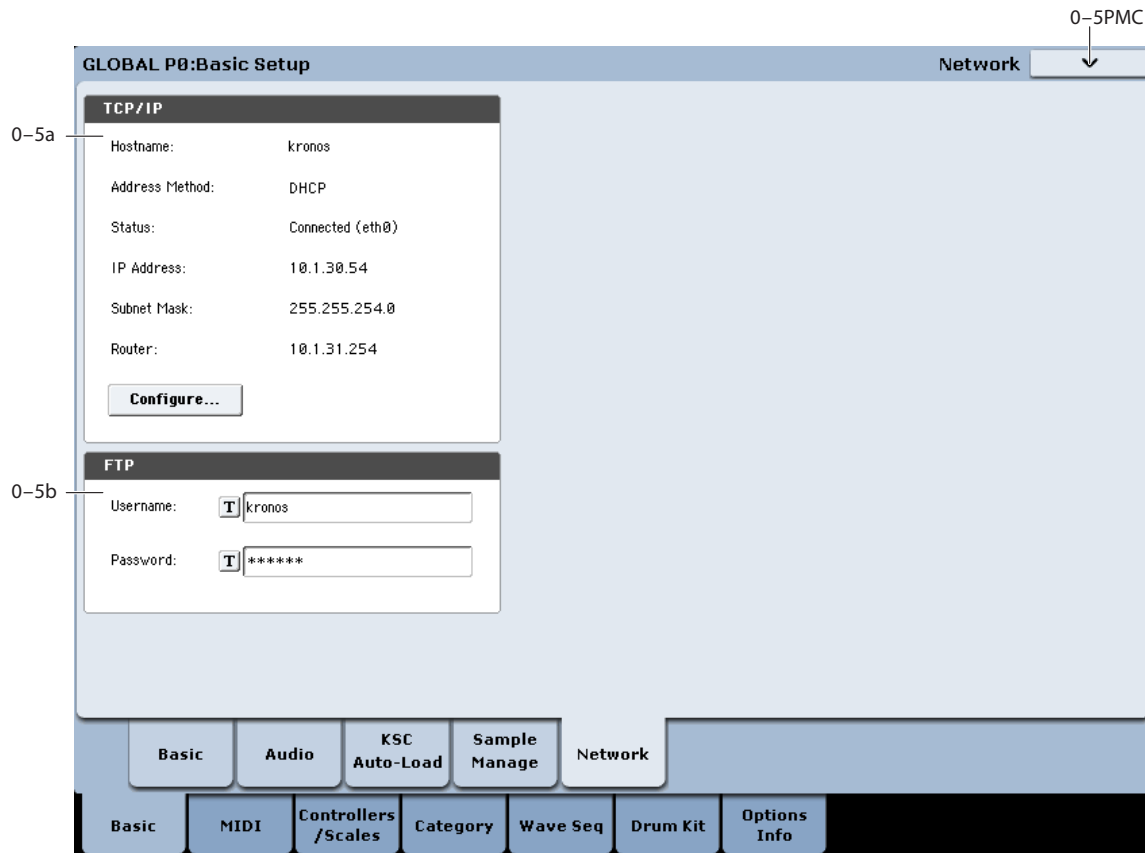

This page lets you set up the USB ethernet connection, and configure the built-in FTP server for file transfers between the KRONOS and your computer.

### Important: compatible USB ethernet adaptor required

The KRONOS supports a specific set of off-the-shelf USB Ethernet adaptors. Adaptors other than those listed below will not function properly.

Supported adaptors as of May 2012 are:

- Apple USB Ethernet Adapter (MC704ZM/A)
- Cisco Linksys USB-300M
- TRENDnet TU2-ET100
- BUFFALO LUA3-U2-AGT
- BUFFALO LUA3-U2-ATX
- BUFFALO LUA-U2-KTX
- IODATA ETX3-US2
- Logitech LAN-TX/U2B
- Logitech LAN-TX/U2H3
- Planex UE-100TX-G3

### Zero-configuration networking

The KRONOS supports zero-configuration networking, including Bonjour (for Mac OS X and Windows) and Avahi (for Linux). Bonjour is installed on Mac OS X computers by default, and is available as a free download for modern versions of Windows.

With zero-configuration networking, the KRONOS FTP server will appear automatically in any Bonjour or Avahi-enabled FTP software, by name, without the need to enter a numeric IP address.

If your operating system supports zero-configuration networking, but your FTP software does not, you can still avoid numeric IP addresses by using the .local domain:

```
ftp://[username]@[hostname].local
```

For [username] and [hostname], use the User name and Host name shown on the Network page. You can configure both of these as you wish.

### FTP

FTP stands for "File Transfer Protocol," and is a standard way to access files over networks. You can use FTP to transfer files between the KRONOS drive(s) and any modern computer system. If you like, you can also use an FTP client application to copy, move, and rename KRONOS files and folders.

Recent versions of Windows support FTP directly within Windows Explorer; once the volume is mounted, it may be used just like any other disk connected to the computer. There are also third-party FTP client applications, some of them free, which may offer different features.

Mac OS X supports FTP volumes as read-only disks within the Finder. For full read and write support, a third-party FTP client application is required; a variety of free and paid applications are available.



For more details, please see the documentation for your operating system and/or FTP client software.

### Connecting to your computer or network

You can connect the KRONOS directly to an ethernet-enabled computer, or to a network. The steps are the same either way:

1. **Make sure that zero-configuration networking support, such as Bonjour, is installed on your computer (see above).**
2. **Confirm that the KRONOS Address method is set to DHCP.**

Address method is shown near the top of the TCP/IP box on the Network page. If necessary, use the Configure TCP/IP dialog to set this to DHCP; see “Address method” on page 768.

3. **Connect a compatible USB-ethernet adaptor to the KRONOS.**

See “Important: compatible USB ethernet adaptor required,” above.

4. **Connect an ethernet cable between the USB-ethernet adaptor and your computer or network ethernet router.**

That’s it! You can now use your FTP client application to connect to the KRONOS.

---

### 0–5a: TCP/IP

This includes read-only displays of the current TCP/IP network settings, including the host name, address method, IP address, subnet mask, and the router’s address.

For more information about what these settings mean, see “0–5c: Configure TCP/IP dialog,” below. To edit these settings, press the **Configure** button.

**Status** [Connected, Connecting..., Disconnecting..., Cable removed, DHCP timed out, IP address conflict, Config failed, Off]

This shows the current state of the KRONOS network connection. Normal states are shown in black text, and errors are shown in red. If **Status** shows an error, see the tips under “Network Troubleshooting” on page 769.

**Connected** shows that the network connection is active and working properly.

**Connecting...** shows that the KRONOS is in the process of connecting to the network.

**Disconnecting...** shows that the KRONOS is in the process of disconnecting from the network, such as might happen if you change the Address Method from DHCP to Off.

**Cable removed** appears if the KRONOS initially connected with the network, but the cable was then physically disconnected.

**DHCP timed out** appears if the Address Method is set to DHCP, but the KRONOS has not received a response from the router (or other DHCP server). This could be caused by the cable not being connected, or by the DHCP server not working properly.

**IP address conflict** appears if the **Address Method** is set to **Manual** and another machine is detected on the same address.

**Config failed:** This indicates either that the KRONOS was turned on without an ethernet cable connected, or that an internal error has occurred.

**Off:** This will appear if the **Address Method** is set to **None (disable ethernet)**.

### Configure button

Pressing this button brings up the Configure TCP/IP dialog, as described below.

---

### 0–5b: FTP

When connecting to the KRONOS using FTP, you’ll need to enter a user name and password. You can configure these with the parameters below.

**User name** [name]

The user name must be at least one character, and can be up to 32 characters, including letters, numbers, and dashes. The default user name is “kronos.” To edit the name, press the text-entry button and enter the new name using the popup keyboard.

**Password** [text]

The password may be left blank, if you are not concerned about security, and can be up to 32 characters, including letters, numbers, and dashes. The default password is “kronos.” To edit the name, press the text-entry button and enter the new name using the popup keyboard.

---

### 0–5c: Configure TCP/IP dialog

This dialog appears when the **Configure** button is pressed.

**Host name** [name]

This is a plain-text name to identify the KRONOS on the network. The name must include at least one character, and can be up to 63 characters, including letters, numbers, and dashes. The default is simply “kronos.” To edit the name, press the text-entry button and enter the new name using the popup keyboard.

*Note:* while the name can include dashes in the middle of the text, the first and last characters must be either letters or numbers.

**Address method** [DHCP, Manual, None (disable ethernet)]

**DHCP:** This is the default setting, recommended for general use. It allows your router to configure the KRONOS network settings automatically.

For those who are curious, DHCP stands for “Dynamic Host Configuration Protocol.”

**Manual:** This allows you to manually specify the **IP Address, Subnet Mast,** and **Router.** Use **Manual** only if you have specific requirements; otherwise, use **DHCP** instead.

**None (disable ethernet):** This allows you to disable ethernet on the KRONOS, even if an ethernet cable is physically connected.

**OK button**

Pressing the **OK** button will apply any changes to the TCP/IP settings, and then close the dialog.

**Cancel button**

Pressing the **Cancel** button will close the dialog without making any changes to the settings.

**Manual TCP/IP settings**

The **IP Address**, **Subnet Mask**, and **Router** parameters apply only if the **Address method** is set to **Manual**. Otherwise, these parameters are grayed out.

A detailed discussion of TCP/IP is outside the scope of this manual. If you need more information about how to configure the TCP/IP settings, see the documentation for your router or other network equipment.

**IP Address** [numeric address]

This is a unique number which identifies the KRONOS on the ethernet network.

**Subnet Mask** [numeric address]

A subnet is a range of IP addresses. Subnets can be used to create virtual divisions within a larger network, to optimize network traffic. The **Subnet Mask** helps to differentiate between traffic on the local subnet and traffic on the wider network.

In simple networks, such as those in homes or moderately-sized businesses, the **Subnet Mask** should generally be set to 255.255.255.0.

**Router** [numeric address]

This is a unique number which identifies your router on the ethernet network.

---

**Network Troubleshooting**

If the **Status** shows an error, try the following:

1. **If possible, use DHCP instead of manual addressing.**
2. **Make sure that all ethernet cables are connected properly.**

If possible, it's sometimes helpful to swap the cables themselves.

3. **Try restarting the DHCP server (usually, this will be the network router).**

After the steps above, make the KRONOS attempt to reconnect to the network by opening and closing the Configure TCP/IP dialog:

4. **Press the Configure button to open the Configure TCP/IP dialog.**
5. **Press OK to close the dialog.**

The KRONOS will then attempt to reconnect to the network; watch the **Status** parameter to see its progress.

## Global P1: MIDI

### 1-1: MIDI

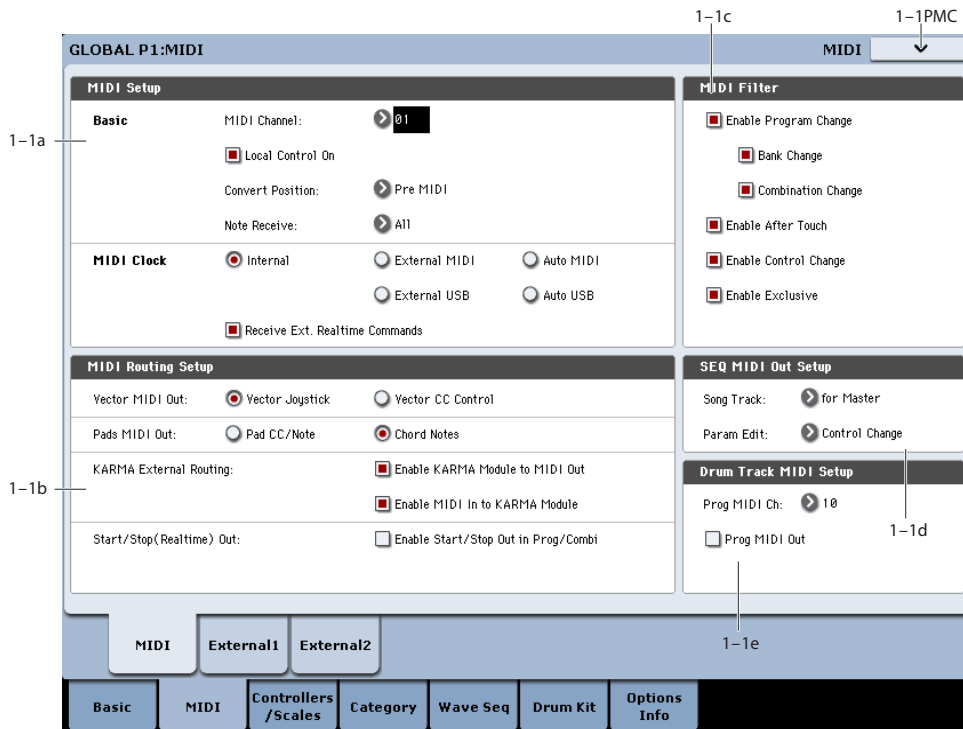

Here you can make MIDI-related settings that affect the entire KRONOS. You can also transmit MIDI System Exclusive data dumps using the page menu commands in this page. Here you can also specify the function of the sliders, knobs, and switches when the control surface CONTROL ASSIGN EXT button is on.

#### 1-1a: MIDI Setup

##### Basic

##### MIDI Channel (Global MIDI Channel) [1...16]

Sets the global MIDI channel.

The global MIDI channel is used in the following cases.

- When transmitting and receiving performance data in Program mode (Program P0: Play) and Sampling mode.
- When selecting combinations via MIDI in Combination mode (Combination P0: Play).
- When selecting Set Lists and Slots via MIDI in Set List mode (Set List P0: Play).
- When controlling timbres or effects that have been set to Gch in various modes
- When transmitting and receiving system exclusive messages

##### MIDI received

In Program mode (P0: Play), MIDI data is received on the global MIDI channel, but in Combination mode (P0: Play) or Sequencer mode, MIDI data is received on the MIDI channel specified for each timbre or track.

In Combination mode (P0: Play), program changes received on the global MIDI channel will switch the combination (1-1c: MIDI Filter).

Use the global MIDI channel to switch IFX 1-12 (CC#92), MFX1&2 (CC#94) and TFX1&2 (CC#95) on/off.

To control the pan following IFX, sends 1/2, MFX 1/2 and TFX1/2, use the global MIDI channel when in the Program or Sampling mode; while in the Combination, or Sequencer modes, use the channel specified separately by **Ctrl Ch** for IFX1-12, MFX1&2, TFX1&2, and MEQ. By setting **Ctrl Ch** to Gch, you can control these parameters from the global MIDI channel.

##### MIDI output when playing KRONOS

In Program mode and Sampling mode, this data will be transmitted on the global MIDI channel. In Combination mode, data will be transmitted simultaneously on the global MIDI channel and on the MIDI channels of timbres whose **Status** (Combination 0-1b, 2-1a) is set to EXT or EX2.

In Sequencer mode, musical data will be transmitted on the channel specified for the currently selected track (Sequencer 0-1a) (whose **Status** is BTH, EXT, or EX2).

##### External mode

In each mode when the control surface CONTROL ASSIGN EXT button is on, you can use the mixer sliders 1-8, master slider, knobs 1-8, and switches 1-16 to control a connected computer or MIDI device.

The MIDI CC# (control change) messages are transmitted on the MIDI channel specified in the Global P1– External 1 and External 2 pages.

### Local Control On [Off, On]

**Local Control On (Checked):** The KRONOS's internal tone generator will be controlled by its own keyboard, joystick, SW1 and SW2, and connected foot pedal. If you are playing the KRONOS by itself, leave this setting checked.

**Local Control Off (Unchecked):** The KRONOS's keyboard and joystick etc. will be disconnected from the internal tone generator.

This means that operating the KRONOS (playing its keyboard and using the joystick, or playing back the sequencer) will not sound its internal tone generator.

Turn **Local Control Off** if loop-back from an external sequencer causes duplicate notes.

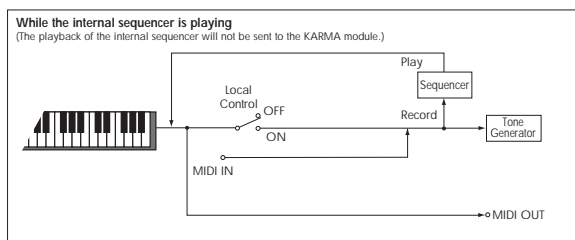
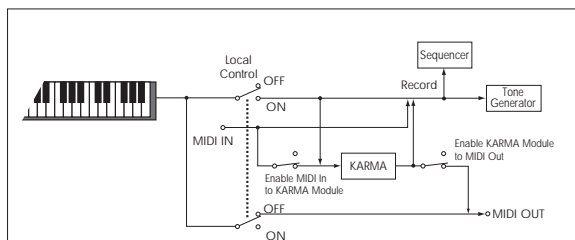

**MIDI** If **Local Control** is Off, MIDI transmission/reception will occur normally. Playing the keyboard will cause the corresponding note data to be transmitted, and received note data will play the KRONOS's internal sounds.

### Local Control and the Control Surface

The Control Surface generates and receives MIDI CCs and System Exclusive messages, so that you can record knob, switch, and slider movements into a sequencer. In order to avoid feedback loops and other strange behavior, the Control Surface relies upon an external MIDI loop-back when **Local Control** is turned Off.

In other words:

- If **Local Control** is On, the physical Control Surface will work properly as long as MIDI is **not** being looped back into the KRONOS.
- If **Local Control** is Off, you **must** loop back MIDI into the KRONOS in order for the physical Control Surface to work properly.
- Regardless of the **Local Control** setting, you can always edit Control Surface parameters via the touch-screen.

**Knob/Slider Mode:** To avoid potential problems when **Local Control** is Off, most knobs and sliders behave as if the **Knob/Slider Mode** was set to Jump. The exception is when **Control Assign** is set to **External**, in which case the **Knob/Slider Mode** setting is observed.

For more information, see “Knob/Slider Mode” on page 757.

### Local Control and the Control Surface: more detail

The information under “Local Control and the Control Surface,” above, is all that you should need to know in most cases. The following information details how the system works internally. You’ll notice the results of these internal operations only if **Local Control** is Off AND there is no MIDI loop-back—which is not a recommended configuration.

In this case, you’ll see that the Control Surface works in slightly different ways, depending on the **Control Assign** setting.

When **Control Assign** is set to **Timbre/Track** or **Audio**:

- If **Local Control** is Off, most of the knobs, sliders, and switches will only affect the internal sounds when MIDI is looped back into KRONOS. The exception is the **Select** switches, which always control the selection.

When **Control Assign** is set to **External**:

- The Control Surface will function properly regardless of the **Local Control** setting.

When **Control Assign** is set to **Real-Time Knobs/KARMA**:

- If **Local Control** is Off, the Real-Time Knobs will only affect the internal sounds when MIDI is looped back into KRONOS.
- The KARMA sliders and switches will function properly regardless of the **Local Control** setting.

When **Control Assign** is set to **Tone Adjust**:

- If **Local Control** is Off, the knobs, sliders, and switches will only affect the internal sounds when MIDI is looped back into KRONOS.

*Local Control and the Control Surface: system diagrams*

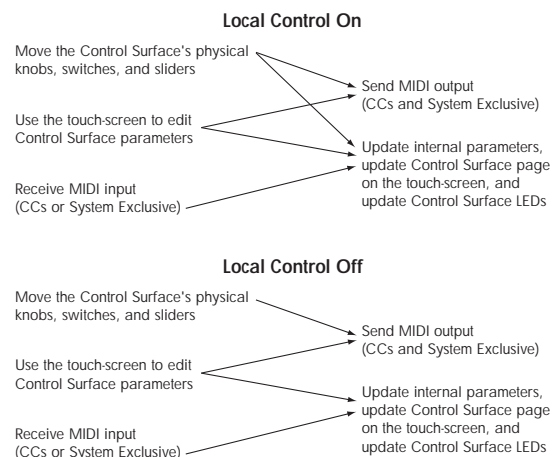

**Assignable Pedals:** When assignable pedals are routed to duplicate the function of a knob, they act the same as the physical knob.

**RESET CONTROLS** button: **Local Control** does not change the way that the Control Surface interacts with **RESET CONTROLS**. For instance, if **Local Control** is Off, holding **RESET CONTROLS** and moving a knob will still reset the knob.

**Other Control Surface buttons:** the **CONTROL ASSIGN** buttons, the **MIXER KNOBS** button, and the **SOLO** button are not affected by **Local Control**.

**Convert Position [PreMIDI, PostMIDI]**

This setting controls how the **Transpose**, **Velocity Curve**, and **After Touch Curve** settings work.

You can think of these as a group of MIDI effects processors, which can be used in one of two places within the KRONOS system.

*Note:* Regardless of the **Convert Position**, these settings always apply when playing internal sounds directly from the KRONOS keyboard.

**PreMIDI** is the default; it places the processors at the output of the KRONOS keyboard. This means that they affect both MIDI data transmitted by playing the keyboard, and data recorded from the keyboard into the internal sequencer. They do *not* affect either incoming MIDI data or data played back by the internal sequencer.

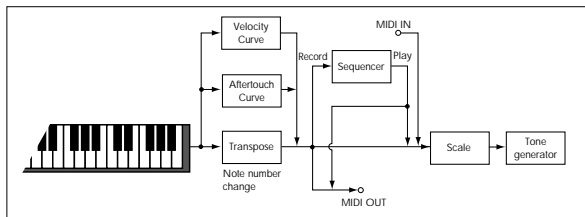

**PostMIDI** places the processors at the input to the KRONOS tone generation. This means that they affect both incoming MIDI data, and data played back by the internal sequencer. They do *not* affect either MIDI output or data recorded into the internal sequencer.

Use **PostMIDI** if you are using an external MIDI controller to play the KRONOS sounds, and want the KRONOS **Transpose**, **Velocity Curve**, and **After Touch Curve** settings to modify the external controller's MIDI output.

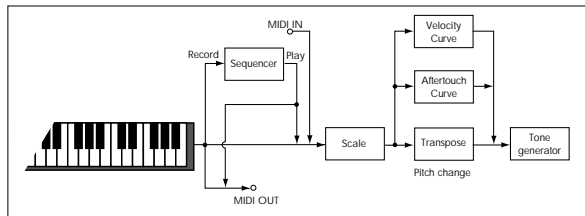

**Note Receive (Note Receive Filter) [All, Even, Odd]**

This setting specifies whether even-numbered, odd-numbered, or all note numbers will be sounded when note data is received from the KRONOS's keyboard or from an external MIDI device. By connecting the KRONOS to another KRONOS and setting one instrument to Even and the other to Odd, you can effectively double the polyphony by dividing the notes between the two instruments.

For use with KARMA and the Drum Track, set the main keyboard to transmit KARMA via MIDI, and set the slave keyboard to All KARMA/DT Off.

**All:** All note numbers will be received. This is the default setting.

**Even:** Only even-numbered notes (C, D, E, F#, G#, A#) will sound.

**Odd:** Only odd-numbered notes (C#, D#, F, G, A, B) will sound.

**MIDI** This setting affects only sound generation. Other aspects of the system, such as the sequencer and MIDI through, continue to include all MIDI notes. Also, all notes from the Drum Track Pattern will play, regardless of this setting.

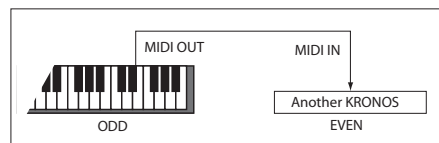

**MIDI Clock**

**MIDI Clock (MIDI Clock Source) [Internal, External MIDI, External USB, Auto MIDI, Auto USB]**

This controls whether the KRONOS uses the internal Tempo setting, synchronizes to incoming MIDI Clocks from external MIDI devices or USB (from a computer-based sequencer, for instance), or automatically switches between the two.

Tempo affects the internal sequencer, KARMA, step sequencers, and tempo-sync'd Wave Sequences, LFOs, and delay times.

**Internal:** The KRONOS will use the internal tempo setting, as determined by the Tempo parameter, Tempo knob, and Tap Tempo button.

Select **Internal** when using the KRONOS by itself, or when you want the KRONOS to control the tempo of external MIDI devices, such as a sequencer or drum machine.

**External MIDI:** The KRONOS tempo will synchronize to incoming MIDI Clock messages.

*Note:* this setting relies on MIDI Clocks being received from an external device, such as a sequencer or drum machine. If MIDI Clocks are not being received, tempo-related features will not function: KARMA will not play, Wave Sequences will not move from step to step, etc.

**External USB:** The KRONOS tempo will synchronize to incoming MIDI Clock messages from the USB B port. Use this when connected to a computer via USB. As with **External MIDI**, if clocks are not being received, tempo-related features will not function.

**Auto MIDI:** This combines the functionality of **Internal** and **External MIDI**, so that you don't have to manually switch between the two:

- If MIDI Clocks are being received, they control the KRONOS tempo.
- If MIDI Clocks are not being received, the KRONOS uses its internal tempo instead.

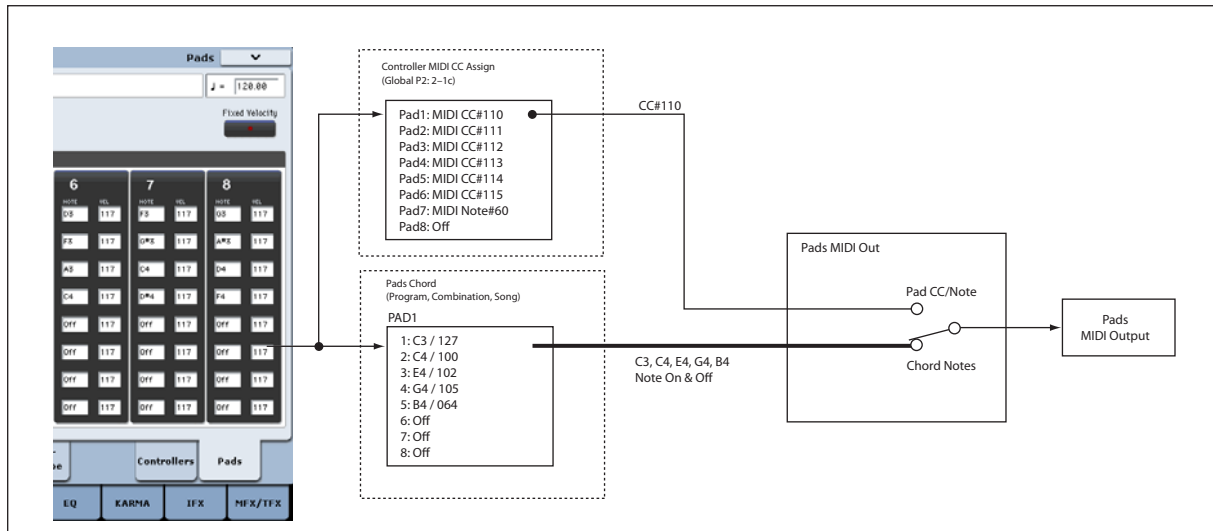

**Auto** defaults to using the internal tempo, and then automatically switches to external if MIDI Clock messages are received. It will then switch back to internal tempo in the following circumstances:

- If after receiving a MIDI Clock, Start, or Continue message, no new MIDI Clock message is received within 500 ms.
- If you start the KRONOS's sequencer from the front panel without having received a MIDI Clock, Start, or Continue message.

**Auto USB:** This combines the functionality of **Internal** and **External USB**, so that you don't have to manually switch between the two. The other details are identical to **Auto MIDI**, above.

**Receive Ext. Realtime Commands [Off, On]**

**Off (unchecked):** The KRONOS will not respond to most MIDI Common and Realtime messages, including Song Position Pointer, Start, Continue, and Stop. Song Select messages will still be recognized, however.

*Note:* Use this setting if the above messages from an external MIDI sequencer are unnecessarily resetting the KRONOS's Song parameters.

**On (checked):** The above Common messages (including Song Select) and Realtime messages will be received.

**MIDI** This parameter cannot be set if **MIDI Clock** is set to **Internal**.

**1-1b: MIDI Routing Setup**

**Vector MIDI Out [Vector Joystick, Vector CC Control]**

This setting specifies the MIDI output generated by vector joystick operations or vector envelope.

**Vector Joystick:** When you move the vector joystick, the two MIDI control change messages specified by VECTOR "VJS X" and "VJS Y" (2-1c) will be transmitted. By default, "VJS X" is CC#118 and "VJS Y" is CC#119.

Normally you will use the Vector Joystick setting. In this case, the vector envelope will not generate MIDI output. Use this setting if you want to control an external MIDI device by moving the vector joystick, or to record vector joystick movements on the internal sequencer or an external sequencer.

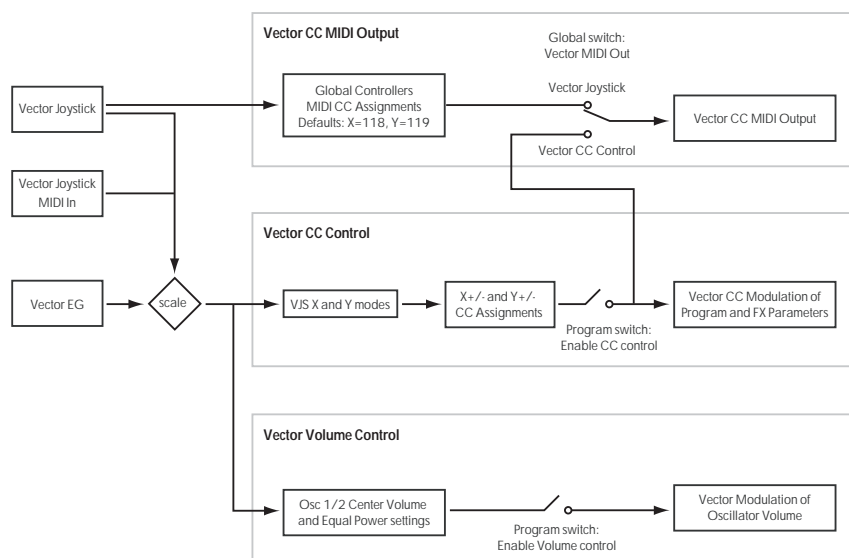



**Vector CC Control:** The KRONOS will transmit the MIDI control change messages specified by the Vector CC Control “+X,” “-X,” “+Y,” and “-Y” settings in each Program, Combination, or Song. Use this setting if you want vector joystick operations or the vector envelope to transmit MIDI control change messages.

Normally you will use this to control the internal tone generator or effects, but you can also use it to transmit messages to an external MIDI device, or to record these movements on the internal sequencer or an external sequencer.

**Pads MIDI Out [Pad CC/Note, Chord Notes]**

The pads can transmit MIDI in one of two different ways. They can either transmit a globally assigned CC or note number, or they can send the chord notes assigned to the pad in the individual Program, Combination, or Song. This setting determines which transmission option will be used.

**Pad CC/Note:** The pad will transmit the globally assigned CC or note number, as set on the Global 2-1: Controllers page. For more information, see “Pads 1-8” on page 782. Note that if the pad is set to Off, no MIDI message will be transmitted.

**Chord Notes:** When you play a pad, the pad’s notes will be transmitted via MIDI. Note that these can be different for each pad in each Program, Combination, and Song. If all notes are turned off, no MIDI messages will be transmitted.

**KARMA External Routing**

**Enable KARMA Module to MIDI Out [Off, On]**

This setting specifies whether the KARMA Module will transmit MIDI messages.

**On (checked):** The KARMA Module will transmit MIDI messages.

**Off (unchecked):** The KARMA Module will not transmit MIDI messages. MIDI events generated by the KARMA Module will sound the internal tone generator, but MIDI messages will not be output.

**Enable MIDI In to KARMA Module [Off, On]**

This setting specifies whether MIDI messages from the MIDI IN connector will be sent to the KARMA Module.

**On (checked):** MIDI messages will be sent to the KARMA Module.

**Off (unchecked):** MIDI messages will not be sent to the KARMA Module.

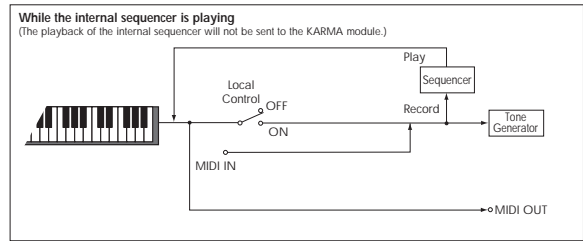
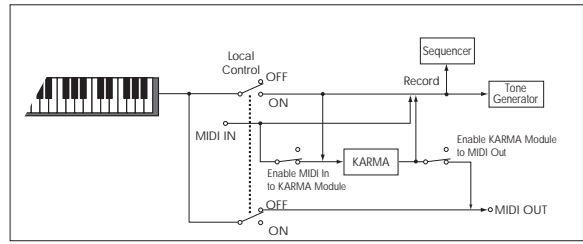

**Example settings**

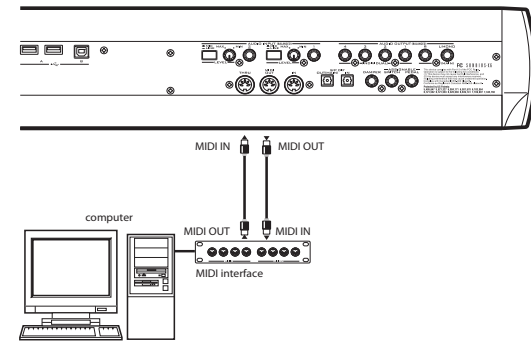

- If you want phrases etc. generated by the KRONOS’s KARMA Module to be sent via MIDI to control an external MIDI device or recorded on an external MIDI sequencer:

“Enable KARMA Module to MIDI Out” On  
 “Enable MIDI In to KARMA Module” Off  
 (“Local Control On” On)

- If you want MIDI input from an external MIDI device to trigger the KARMA Module
- If you want only the KRONOS keyboard events that trigger the KARMA Module to be sent from MIDI OUT for recording on an external sequencer, and echo-back or play back these events via MIDI IN to trigger the KARMA Module:

“Enable KARMA Module to MIDI Out” Off  
 “Enable MIDI In to KARMA Module” On  
 (“Local Control On” Off)

You can also make these settings from the “Setup KARMA External MIDI Routing” (o) page menu command.

**MIDI** If both **Enable KARMA Module to MIDI Out** and **Enable MIDI In to KARMA Module** are turned On, there is a possibility of a MIDI Loop occurring, depending on the settings of any connected external devices. If this happens, disable the “Echo Thru” settings of the external devices, or set one of these KARMA MIDI settings to Off. See “Set Up KARMA External MIDI Routing” on page 811.



## Start/Stop (Realtime) Out

### Enable Start/Stop Out in Prog/Combi [Off, On]

In Program and Combination modes, this function transmits a MIDI start message when you trigger KARMA, and a MIDI stop message when you turn it off. This lets you make an external MIDI sequencer or rhythm/groove machine start playing at the moment that KARMA begins playing.

**Off (unchecked):** Normally you will leave this Off.

**On (checked):** MIDI system realtime messages “Start” and “Stop” will be transmitted in Program and Combination mode. If **MIDI Clock** (1-1a) is set to Internal or Auto (and operating as Internal), the start and stop messages will be transmitted under the conditions described below. This can be used to simultaneously start an external MIDI sequencer or rhythm/groove machine at the moment KARMA begins playing.

**Start:** If the KARMA ON/OFF switch is on, the MIDI system realtime message “Start” will be transmitted at the moment you use the keyboard to trigger the GE.

*Note:* “Start” will be transmitted at the moment that the GE phrase or pattern is triggered, according to the module’s “KARMA Key Zone” setting (Program 7-1a, Combination 7-1b).

**Stop:** If “Start” has been previously transmitted, the MIDI system realtime message “Stop” will be transmitted at the moment you turn off the KARMA ON/OFF switch.

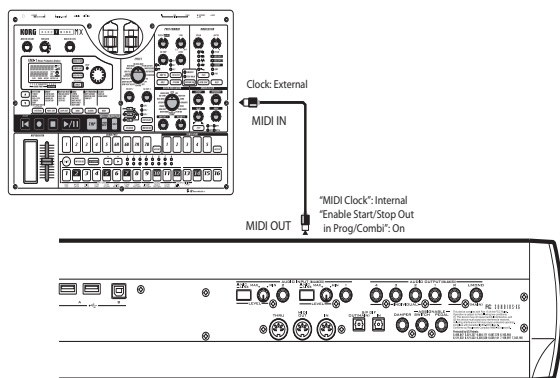

For more information, see “Connecting MIDI devices & computers” on page 1127, “Synchronizing the playback of KARMA or sequencer” on page 1138, and “Synchronizing KARMA” on page 235 of the Operation Guide.

## 1-1c: MIDI Filter

### Enable Program Change [Off, On]

**On (checked):** Program changes will be transmitted and received.

In Program mode (P0: Play), the program will be switched when a program change message is received on the global MIDI channel specified by **MIDI Channel** (1-1a). When you switch programs, a program change message will be transmitted on the global MIDI channel.

In Combination mode (P0: Play), the combination will be switched when a program change message is received on the global MIDI channel. However, it is possible to set the “Enable Combination Change” parameter so that the combination is not switched. When a program change is received on the channel specified for each timbre by **MIDI Channel** (Combination 2-1a), the program of that timbre will be switched. However, the program changes for each timbre will be affected by the setting of the “Enable Program Change” parameter (Combination 3-1a).

When you switch combinations, a program change message will be transmitted on the global MIDI channel, and also transmitted simultaneously on the channel of timbres whose **Status** (Combination 0-1b, 2-1a) is set to EXT or EX2.

In Sequencer mode, incoming program change messages on a channel that corresponds to a track whose **Status** (Sequencer 2-1a) is set to INT or BTH will switch programs on that track. When you select a song or playback sequencer data, program changes will be transmitted on the channels of tracks whose **Status** is set to BTH, EXT, or EX2.

In Set List mode (P0: Play), the slot will be switched when a program change message is received on the global MIDI channel. When you switch slots, a program change message will be transmitted on the global MIDI channel. If the Slot contains a Combination or Song, other program change messages may be transmitted on additional MIDI channels, as would normally occur in Combination or Sequencer modes.

**Off (unchecked):** Program changes will not be transmitted or received.

### Bank Change [Off, On]

**On (checked):** The Bank Select control change message will be transmitted together with program change messages. This is valid when “Enable Program Change” is checked.

**Off (unchecked):** Bank Select messages will not be transmitted or received.

When recording on the internal sequencer, bank select messages will be recorded regardless of this setting. However for playback, this setting will apply.

This also controls send and receive of Bank Select messages for Set List selection in Set List mode.

### Combination Change [Off, On]

**On (checked):** When in Combination P0: Play, an incoming program change message on the global MIDI channel set by **MIDI Channel** (1-1a) will switch Combinations.

This is valid when “Enable Program Change” is checked.

An incoming program change on a channel other than the global MIDI channel will switch the program of any timbre that matches that MIDI channel.

**Off (unchecked):** An incoming program change message on the global MIDI channel will switch the program of any timbre whose **MIDI Channel** (Combination 2-1a) matches the global MIDI channel. The combination will not be switched.

The program changes for each timbre will be affected by the setting of the “Enable Program Change” parameter (Combination 3–1a).

**Enable After Touch** [Off, On]

**On (checked):** MIDI after touch messages will be transmitted and received.

**Off (unchecked):** MIDI after touch messages will neither be transmitted from the local keyboard, nor received.

When recording sounds that do not require the use of after touch, you can uncheck this parameter to save memory in the sequencer.

**Note:** This setting doesn’t affect playback of previously recorded data from the internal sequencer. If you’ve already recorded aftertouch into a MIDI track, it will still both affect internal sounds and be transmitted via MIDI, regardless of this setting.

The KRONOS’s keyboard transmits only channel after touch; it does not transmit polyphonic after touch.

However, since the KRONOS does support polyphonic after touch as an Alternate Modulation Source (AMS), it can receive polyphonic after touch to control individual notes.

**Enable Control Change** [Off, On]

**On (checked):** Control change messages will be transmitted and received.

**Off (unchecked):** Control change messages will neither be transmitted nor received.

This setting has no effect when you use the internal sequencer to playback sequence data that was recorded with control change data; i.e., the control changes previously recorded into the sequencer will be transmitted via MIDI.

**Enable Exclusive** [Off, On]

**On (checked):** System exclusive data will be transmitted and received.

Check this if you want to edit the KRONOS from a connected computer, or if you want to allow bi-directional editing.

**Off (unchecked):** System exclusive data will not be transmitted. Normally you will leave this unchecked.

However, system exclusive data will be transmitted and received while the page menu commands (“Dump Program”–“Dump All”) of this page are displayed.

---

**1–1d: SEQ MIDI Out Setup**

**Song Track** [for Master, for External Seq]

This setting specifies what will be transmitted via MIDI when you switch songs in Sequencer mode.

**for Master:** When you switch songs in Sequencer mode, tracks whose Status is EXT or BTH will transmit MIDI messages\* such as program changes to set-up an external MIDI sound module.

**for External Seq:** Choose this option if you’re using Sequencer mode as an external multi-timbral sound module. When you switch songs on the KRONOS, no

track whose Status is set to EXT or BTH (i.e., any setting other than INT) will transmit MIDI messages\* such as program changes. This prevents echo-back from the tracks of your external MIDI sequencer from overwriting the program and other parameters of tracks that are set to the same MIDI channel.

\* Applicable MIDI messages and corresponding parameters:

- Program Select: CC#00 bank select (LSB), CC#32 bank select (MSB), program change
- Volume: CC#7 volume
- Pan: CC#10 pan
- Portamento: CC#65 portamento On/Off, CC#5 portamento time
- Send 1/2: CC#93 send 1 level, CC#91 send 2 level
- (Post FX) Pan: CC#8 post insert effect pan

**Param Edit** [Control Change, SysEx Param Change]

This setting specifies whether control changes or system exclusive messages will be transmitted when you edit a parameter in Sequencer mode.

**Control Change:** Data for the edited parameter will be transmitted as a control change.

**SysEx Param Change:** Data for the edited parameter will be transmitted as a parameter change.

**Note:** For these to operate, Enable Control Change or Enable Exclusive (Global P1: MIDI– MIDI Routing) must be checked respectively.

\* Applicable MIDI messages and corresponding parameters:

- Volume: CC#7 volume
- Pan: CC#10 pan
- Send 1/2: CC#93 send 1 level, CC#91 send 2 level

---

**1–1e: Drum Track MIDI Setup**

In Program mode, if the **Trigger Mode** is set to Wait KBD Trig, the Drum Track starts and stops in response to the global MIDI channel. However, you can also play the Drum Track Program directly via MIDI on a separate channel, and optionally transmit the Drum Track Pattern to MIDI out.

*Note:* Drum Track Programs do not transmit or receive MIDI program changes.

**Prog MIDI Ch** [01...16]

This sets the MIDI channel for drum track transmission and reception in Program mode. This means that you can play the Drum Track Program separately from the main Program via MIDI, if desired.

If **Prog MIDI Out** is On (checked), drum pattern note data will be transmitted on this MIDI channel. The default setting is channel 10.

**Prog MIDI Out** [Off, On]

**On (checked):** The note data of the drum track pattern will be transmitted on the channel specified by Prog MIDI Ch.

Off (unchecked): The note data of the drum track pattern will not be transmitted.

### ▼ 1-1: Page Menu Commands

The number before each command shows its ENTER + number-key shortcut. For more information on these shortcuts, see “ENTER + 0-9: shortcuts for menu commands” on page 147.

- 0: **Write Global Setting.** For more information, see “Write Global Setting” on page 806.
- 1: **Dump Program.** For more information, see “Dump Program” on page 809.
- 2: **Dump Combination.** For more information, see “Dump Combination” on page 809.
- 3: **Dump Drum Kit.** For more information, see “Dump Drum Kit” on page 809.
- 4: **Dump Wave Sequence.** For more information, see “Dump Wave Sequence” on page 809.
- 5: **Dump Global Setting.** For more information, see “Dump Global Setting” on page 809.
- 6: **Dump Sequencer.** For more information, see “Dump Sequencer” on page 809.
- 7: **Dump Set List.** For more information, see “Dump Set List” on page 809.
- 8: **Dump Drum Track Pattern.** For more information, see “Dump Drum Track User Pattern” on page 810.
- 9: **Dump KARMA User GE.** For more information, see “Dump KARMA User GE” on page 810.

## 1-2: External 1

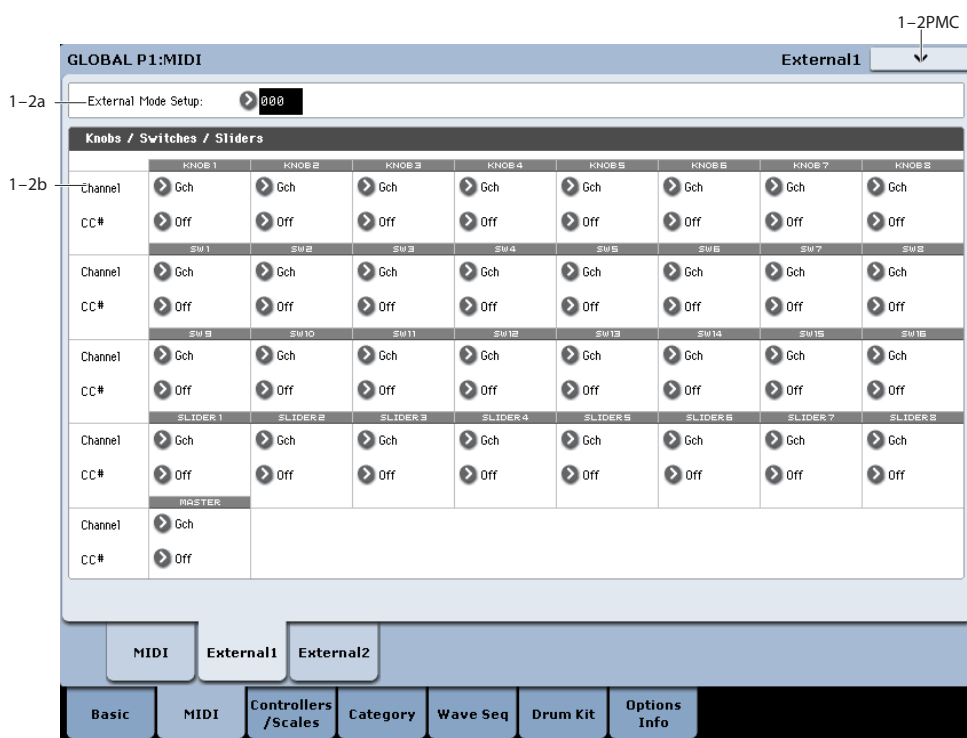

This page lets you set up the knobs, sliders, and switches for the Control Surface’s EXTERNAL mode. In this mode, each slider, knob, and switch can be assigned to a separate MIDI controller and MIDI channel.

The eight pads also have separate settings which apply only when Control Assign is set to External; for more information, see “1-3: External 2” on page 779.

You can create up to 128 different External Setups. For instance, you might make one setup for controlling several different pieces of MIDI gear on stage, another for controlling a software synthesizer (such as one of Korg’s Legacy Collection synths), and so on.

These External Setups are completely separate from the Program. You can think of External mode as being a separate control surface which just happens to share KRONOS’s sliders, knobs, switches, and pads.

When you select an External Setup, it stays selected even when you change Programs, or switch to Combi or Sequencer modes. This makes it easy to select different KRONOS sounds without disrupting any external MIDI control, and vice-versa.

*Note:* After editing the setups, make sure to save your edits using the page menu’s Write Global command. You can also call up this menu command by holding ENTER and pressing 0 on the numeric keypad.

### 1-2a: External Mode Setup

**Setup** [000...127]

This selects the External Setup to edit.

---

**1–2b: Knobs/Switches/Sliders****Knobs 1–8****MIDI Channel (1–8) [1...16, Gch]**

This sets the MIDI Channel for the knob. Each can send on a different channel, if desired.

**Gch** means that the knob will transmit on the Global MIDI Channel, as set in Global mode. This allows you to re-direct any number of sliders, knobs, switches, and pads to a different channel at once, without editing the individual controls.

**CC# Assign (1–8) [Off, 00...119]**

This sets the MIDI CC sent by the knob.

**Switches 1–16****MIDI Channel (1–16) [1...16, Gch]**

This sets the MIDI Channel for the switch. Each can send on a different channel, if desired.

When the switch is turned on, it sends a value of 127; when it is turned off, it sends a value of 0.

**Gch** means that the slider will transmit on the Global MIDI Channel, as set in Global mode.

**CC# Assign (1–16) [Off, 00...119]**

This sets the MIDI CC sent by the switch.

**Sliders 1–8 and Master****MIDI Channel (1–8) [1...16, Gch]**

This sets the MIDI Channel for the slider. Each can send on a different channel, if desired.

**Gch** means that the slider will transmit on the Global MIDI Channel, as set in Global mode.

**CC# Assign (1–8) [Off, 00...119]**

This sets the MIDI CC sent by the slider.

- 7: **Dump Set List**. For more information, see “Dump Set List” on page 809.
- 8: **Dump Drum Track Pattern**. For more information, see “Dump Drum Track User Pattern” on page 810.
- 9: **Dump KARMA User GE**. For more information, see “Dump KARMA User GE” on page 810.
- 10: **Setup KARMA External MIDI Routing**. For more information, see “Set Up KARMA External MIDI Routing” on page 811.
- 11: **Reset External Setup**. For more information, see “Reset External Setup” on page 812.

---

**▼ 1–2: Page Menu Commands**

The number before each command shows its ENTER + number-key shortcut. For more information on these shortcuts, see “ENTER + 0-9: shortcuts for menu commands” on page 147.

- 0: **Write Global Setting**. For more information, see “Write Global Setting” on page 806.
- 1: **Dump Program**. For more information, see “Dump Program” on page 809.
- 2: **Dump Combination**. For more information, see “Dump Combination” on page 809.
- 3: **Dump Drum Kit**. For more information, see “Dump Drum Kit” on page 809.
- 4: **Dump Wave Sequence**. For more information, see “Dump Wave Sequence” on page 809.
- 5: **Dump Global Setting**. For more information, see “Dump Global Setting” on page 809.
- 6: **Dump Sequencer**. For more information, see “Dump Sequencer” on page 809.

## 1-3: External 2

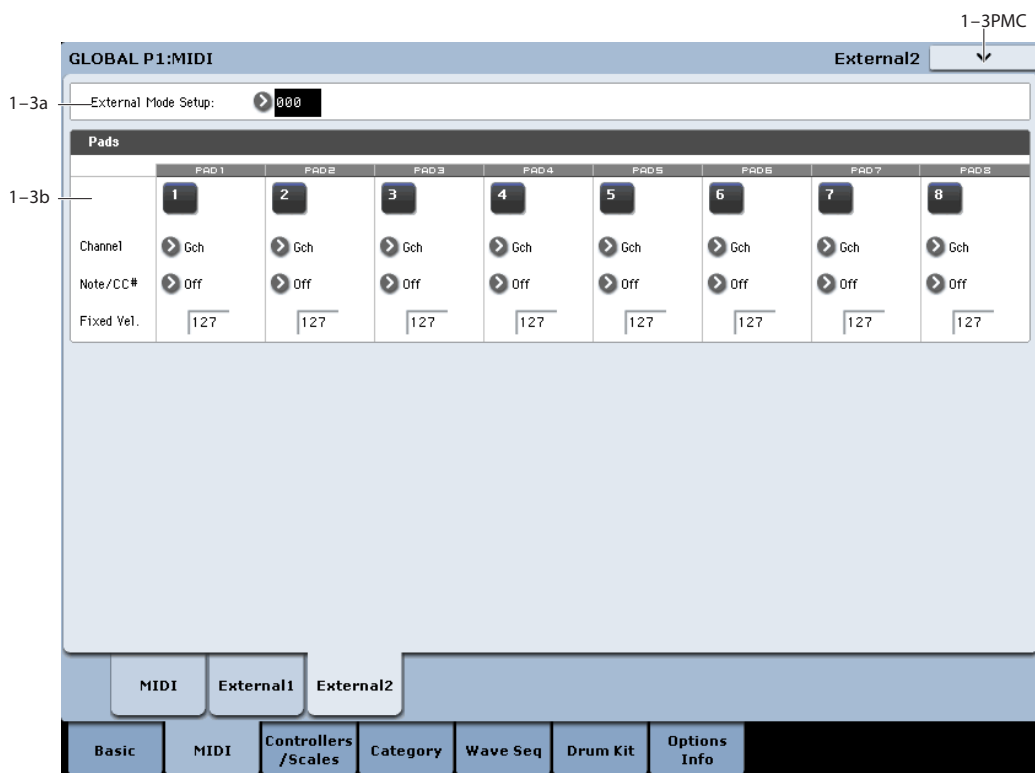

This page lets you set up the pad assignments for the Control Surface's EXTERNAL mode. Each pad can play a note, or send a Control Change (CC) message, on any of the MIDI channels. These settings apply both to the on-screen pads and to a compatible USB MIDI pad device, if connected. For more information, see "1-2: External 1" on page 777.

### 1-3a: Setup select

**Setup** [000...127]

This selects the Global setup to edit.

### 1-3b: Pads 1-8

**MIDI Channel (1-8)** [1...16, Gch]

This sets the MIDI Channel for the pad. Each can send on a different channel, if desired.

**Gch** means that the pad will transmit on the Global MIDI Channel, as set in Global mode. This allows you to re-direct any number of sliders, knobs, switches, and pads to a different channel at once, without editing the individual controls.

**Assign (1-8)** [Off, C-1...G9, CC#00...119]

Each pad can send either a MIDI note or a MIDI CC message. When assigned to a CC, the pad sends a value of 127 when it is pressed down, and a value of 0 when it is released.

**Velocity (1-8)** [1...127]

This sets the pad's fixed velocity for the setup.

The **Fixed Velocity** button (on the Pads page in each mode) controls whether or not the pads respond to how hard you play. This setting is stored with each Program, Combi, and Song.

In **Fixed Velocity** mode, the pads always use their stored velocity settings.

In **Velocity Sensitive** mode, touching the top of the pad very strongly produces the preset velocity. When you play towards the bottom of the pad, the preset velocity is scaled down accordingly.

For more information, see "1-9: Pads" on page 54.

### ▼ 1-3: Page Menu Commands

The number before each command shows its ENTER + number-key shortcut. For more information on these shortcuts, see "ENTER + 0-9: shortcuts for menu commands" on page 147.

- **0: Write Global Setting.** For more information, see "Write Global Setting" on page 806.
- **1: Dump Program.** For more information, see "Dump Program" on page 809.
- **2: Dump Combination.** For more information, see "Dump Combination" on page 809.
- **3: Dump Drum Kit.** For more information, see "Dump Drum Kit" on page 809.
- **4: Dump Wave Sequence.** For more information, see "Dump Wave Sequence" on page 809.
- **5: Dump Global Setting.** For more information, see "Dump Global Setting" on page 809.
- **6: Dump Sequencer.** For more information, see "Dump Sequencer" on page 809.

- 7: **Dump Set List.** For more information, see “Dump Set List” on page 809.
- 8: **Dump Drum Track Pattern.** For more information, see “Dump Drum Track User Pattern” on page 810.
- 9: **Dump KARMA User GE.** For more information, see “Dump KARMA User GE” on page 810.
- 10: **Setup KARMA External MIDI Routing.** For more information, see “Set Up KARMA External MIDI Routing” on page 811.
- 11: **Reset External Setup.** For more information, see “Reset External Setup” on page 812.

## Global P2: Controllers/Scales

### 2-1: Controllers

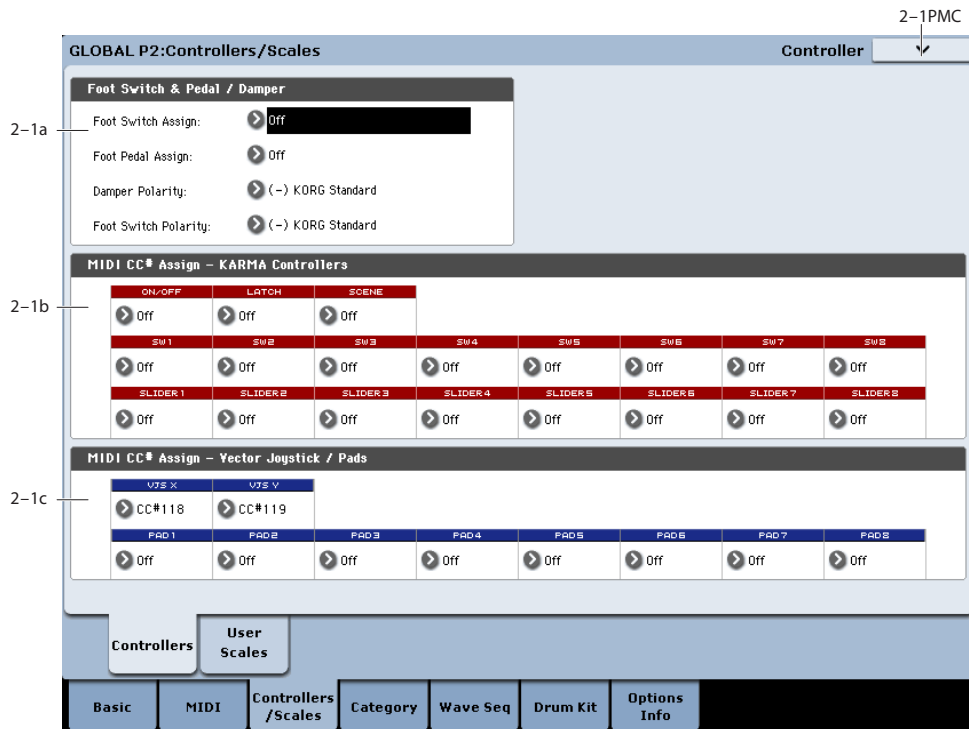

#### 2-1a: Foot Switch & Pedal/Damper

##### Foot Switch Assign [Off...SW 2]

This selects the function that will be controlled by a pedal switch (such as the optional Korg PS-1) connected to the ASSIGNABLE SWITCH jack.

For a complete list of possible assignments, please see "Foot Switch Assignments" on page 1106.

##### Foot Pedal Assign [Off...Knob 4]

Selects the function that will be controlled by a volume pedal (such as the optional XVP-10 or EXP-2) connected to the ASSIGNABLE PEDAL jack.

For a complete list of possible assignments, please see "Foot Pedal Assignments" on page 1108.

##### Damper Polarity [(-) Korg Standard, (+)]

Set this to match the polarity of the damper pedal connected to the DAMPER jack. If the polarity does not match, operating the damper pedal will not produce the correct result. If no damper pedal is connected, set this to (-) Korg Standard.

**(-) Korg Standard:** Use this setting for "open-type" damper pedals, such as the optional Korg DS-1H.

**(+):** Use this setting for "closed-type" pedals.

##### Foot Switch Polarity [(-) Korg Standard, (+)]

Set this to match the polarity of the footswitch connected to the ASSIGNABLE SWITCH jack. If the polarity does not match, operating the damper pedal will not produce the correct result. If no damper pedal is connected, set this to (-) Korg Standard.

**(-) Korg Standard:** Use this setting for "open-type" footswitches, such as the optional Korg PS-1.

**(+):** Use this setting for "closed-type" pedals.

#### 2-1b: MIDI CC# Assign —KARMA Controllers

All of the front-panel KARMA controls can optionally be assigned to MIDI Control Change messages (CCs). When you operate a switch or slider, the assigned CC will be transmitted via MIDI; when received from MIDI input, the CC will control the corresponding KARMA function.

##### Default CC assignments

As shipped from the factory, for simplicity, all KARMA and Pad assignments are set to Off. However, the KRONOS has a set of recommended CC assignments which can be loaded in a single step. To do so:

1. Select the menu command **Reset Controller MIDI Assign.**

A dialog box will appear.

2. Set the **To** menu to **CC Default.**

3. Press **OK.**



The controls for KARMA, the pads, and the Vector Joystick will all be set to their recommended CC assignments. For more information, see “Reset Controller MIDI Assign” on page 812.

If you prefer, you may also manually assign the controls to any other CCs. Make sure to write the Global settings in order to preserve your edits!

### **KARMA ON/OFF** [Off, MIDI CC#00...119]

This assigns a control change message to the KARMA ON/OFF switch. When assigned to a CC, the default is CC#14.

### **KARMA SCENE** [Off, MIDI CC#00...119]

This assigns a control change message to the KARMA SCENE switch. When assigned to a CC, the default is CC#30. CC values of 0...7 select Scenes 1...8; other values are ignored.

### **KARMA LATCH** [Off, MIDI CC#00...119]

This assigns a control change message to the KARMA LATCH switch. When assigned to a CC, the default is CC#31.

### **KARMA Sliders 1-8** [Off, MIDI CC#00...119]

These assign control change messages to each of the KARMA CONTROL sliders. When assigned to CCs, the defaults are CC#s 22...29.

### **KARMA Switches 1-8** [Off, MIDI CC#00...119]

These assign control change messages to each of the KARMA SWITCHES. When assigned to CCs, the defaults are CC#s 102...109.

---

## **2-1c: MIDI CC# Assign** **—Vector Joystick / Pads**

### **VJS X** [Off, MIDI CC#00...119]

### **VJS Y** [Off, MIDI CC#00...119]

These assign control change messages to the X-axis and Y-axis of the Vector Joystick. When assigned to CCs, the defaults are CC#s 118 (VJS X) and 119 (VJS Y).

For more information, see “1-1b: MIDI Routing Setup” on page 773.

**MIDI Important:** If you set these to Off, the Vector Joystick will truly be off; it will neither send MIDI, nor affect the internal sounds.

### **Pads 1-8** [Off, Note C-1...G9, MIDI CC#00...#119]

These assign note numbers or control change messages to Pads 1-8. If received via MIDI In, or played on the Global Channel from the local keyboard, these will trigger the pads. When assigned to CCs, the defaults are CC#s 110...117. For more information, see “Default CC assignments” on page 781.

Optionally, the Pads can also transmit these messages instead of their assigned chord notes. For more information, see “Pads MIDI Out” on page 774.

---

## **▼ 2-1: Page Menu Commands**

The number before each command shows its ENTER + number-key shortcut. For more information on these shortcuts, see “ENTER + 0-9: shortcuts for menu commands” on page 147.

- **0: Write Global Setting.** For more information, see “Write Global Setting” on page 806.
- **1: Reset Controller MIDI Assign.** For more information, see “Reset Controller MIDI Assign” on page 812.

## 2-2: User Scale

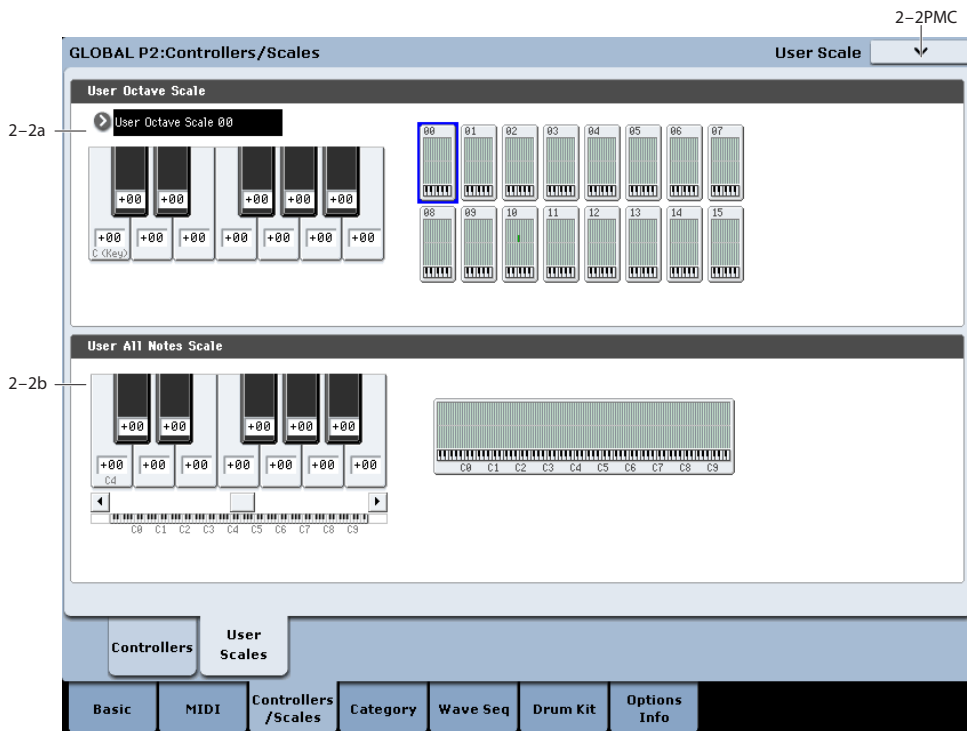

Here you can make settings for sixteen different User Octave Scales and one User All Notes scale.

The user scales you create here can be selected from the following pages.

- HD-1 Program P1– Program Basic
- EXi Program Common P1– Program Basic
- Combination P2– Pitch
- Sequencer P2– Pitch

**MIDI** If you wish to keep an edited user scale after the power is turned off, be sure to write (save) your settings.

Use the page menu command **Write Global Setting** or press the SEQUENCER REC/WRITE switch to open the dialog box, and write the data.

### 2-2a: User Octave Scale

#### User Octave Scale [User Octave Scale 00...15]

Selects the User Octave Scale that you want to edit.

#### Tune [-99...+99]

Makes pitch settings for each note in the octave.

When you adjust the pitch of each note in the octave (C–B) in one-cent steps, your settings will be applied to all octaves. This adjustment is relative to equal temperament.

A setting of **-99** lowers the pitch approximately a semitone below normal pitch.

A setting of **+99** raises the pitch approximately a semitone above normal pitch.

The note can also be selected by holding down the ENTER switch and playing a note on the keyboard.

By executing the page menu command “Copy Scale,” you can copy settings from a preset scale (other than Stretch) or from another user scale.

### 2-2b: User All Notes Scale

#### Tune [-99...+99]

Makes independent pitch settings for each of the 128 notes.

Adjust the pitch of each of the 128 notes (C–1 – G9) in one-cent steps. This adjustment is relative to equal temperament.

A setting of **-99** lowers the pitch approximately a semitone below normal pitch.

A setting of **+99** raises the pitch approximately a semitone above normal pitch.

Use the horizontal scroll bar to move to the key range that you want to set, and select the key that you want to specify.

*Note:* The note can also be selected by holding down the ENTER switch and playing a note on the keyboard.

By executing the page menu command “Copy Scale,” you can copy settings from a preset scale (including Stretch) or another user scale.

### ▼ 2-2: Page Menu Commands

The number before each command shows its ENTER + number-key shortcut. For more information on these shortcuts, see “ENTER + 0-9: shortcuts for menu commands” on page 147.

- **0: Write Global Setting.** For more information, see “Write Global Setting” on page 806.

- 1: **Copy Scale**. For more information, see “Copy Scale” on page 812.

## Global P3: Category Name

Programs, Combinations, and KARMA GEs are organized into categories and sub-categories. Categories make it easy to find a particular type of sound, such as keyboards, bass, or drums, or a specific type of KARMA GE, such as arpeggios or gated patterns.

Each main category also has up to 8 sub-categories, for finer degrees of organization. For instance, the Program keyboard category has sub-categories for acoustic pianos, real electric pianos, synth electric pianos, and clavs and harpsichords.

Anywhere that you can select Programs, Combinations, or KARMA GEs by bank and number, you can also select them from the category pop-up.

When shipped from the factory, there are 16 preset Program and Combination categories, with 2 more left open for your use (initially named User16 and User17). There are also 12 preset KARMA GE categories.

On these pages, you can:

- Change the names of any of the categories and sub-categories, including both the factory and user categories
- Add sub-categories to the factory categories (up to the limit of 8)

You can assign a Program or Combination to a category and sub-category during the Write process. For more information, see “Write Program” on page 147, and “Write Combination” on page 501.

- 🔧 To save changes to category names, you’ll need to write the Global settings. To do so, use the menu command “Write Global Setting.” For more information, see “Write Global Setting” on page 806.

## 3-1: Program Category

The screenshot shows the 'GLOBAL P3:Category Name' interface. At the top right, there is a dropdown menu labeled 'Program Category' with '3-1PMC' selected. Below this, the interface is divided into two main sections: 'Main Category' and 'Sub Category'. The 'Main Category' section contains 18 text input fields arranged in a 3x6 grid, numbered 00 to 17. The 'Sub Category' section contains a 'Main Category:' label with a dropdown menu showing 'Keyboard', and a 3x3 grid of text input fields numbered 00 to 07. At the bottom of the interface, there are several tabs: 'Program Category', 'Combi Category', and 'KARMA Category'. Below these are more tabs: 'Basic', 'MIDI', 'Controllers / Scales', 'Category', 'Wave Seq', 'Drum Kit', and 'Options Info'. Labels '3-1a' and '3-1b' point to the 'Main Category' and 'Sub Category' sections respectively.

### 3-1a: Main Category

#### Main Category 00...17

#### Main Category Edit [[Text Editor]]

Here you can edit the main category names for programs.

Press the text edit button to open the text edit dialog box, and enter a name. You can enter up to 24 characters. (See “Editing names” on page 184 of the Operation Guide.)

You can name each of the eighteen categories.

### 3-1b: Sub Category

#### Main Category select [00...17]

Here you can select the main category for which you will edit sub-category names.

#### Sub Category 00...07

#### Sub Category Edit [[Text Editor]]

Here you can edit the sub-category names for programs.

Use “Main Category Select” to select the main category that includes the sub-category name you want to edit. Then press the “Sub Category Select” text edit button to open the text edit dialog box, and enter a name. You can enter up to 24 characters.

You can name each of the eight categories.

---

### ▼ 3-1: Page Menu Commands

The number before each command shows its ENTER + number-key shortcut. For more information on these shortcuts, see “ENTER + 0-9: shortcuts for menu commands” on page 147.

- 0: **Write Global Setting**. For more information, see “Write Global Setting” on page 806.

---

## 3-2: Combi Category

---

### 3-3: KARMA Category

These pages let you assign the main category and sub-category names to Combinations and KARMA. Note that currently, you can rename the existing KARMA categories, but you cannot assign a GE to a different category. For more information, please see “3-1: Program Category” on page 785.

## Global P4: Wave Sequence

Wave Sequences play back a series of different Multisamples over time. You can use this to create a variety of unique timbral and rhythmic effects, as described below.

Like Drum Kits, Wave Sequences are edited in Global mode, and then used within HD-1 Programs. For more information on using Wave Sequences in Programs, see “2-1c: OSC1 Multisample/Wave Sequence” on page 58.

When editing Wave Sequences, you’ll hear them as if they were being played through the parameter settings of the previously selected Program or Combination. This includes filter settings, envelopes, etc. So, before you begin, it’s best to first select a suitable sound in Program mode, and then enter Global mode.

For detailed step-by-step instructions on creating and editing Wave Sequences, please see “Using Wave Sequences” on page 168 of the Operation Guide.

### Rhythmic Wave Sequences

Rhythmic Wave Sequences use short or abrupt crossfades, so that transitions between the different Multisamples create a rhythmic phrase. Flexible swing amount, rests, and ties let you build complex patterns, which you can then sync to KARMA and the system tempo.

### Crossfading Wave Sequences

By using long durations and crossfade times, Wave Sequences can produce complex, evolving timbres. Modulating the Start Step, Position, and Duration makes the sound even more organic, so that every note can play the Wave Sequence a little differently.

### Velocity-Switching Wave Sequences

By setting each step’s duration to GATE, and then modulating the Start Step by velocity, you can create a sound with up to 64 velocity switches. For instance, you can use this to switch between a large number of different attack transients.

## 4-1: Sequence Parameters

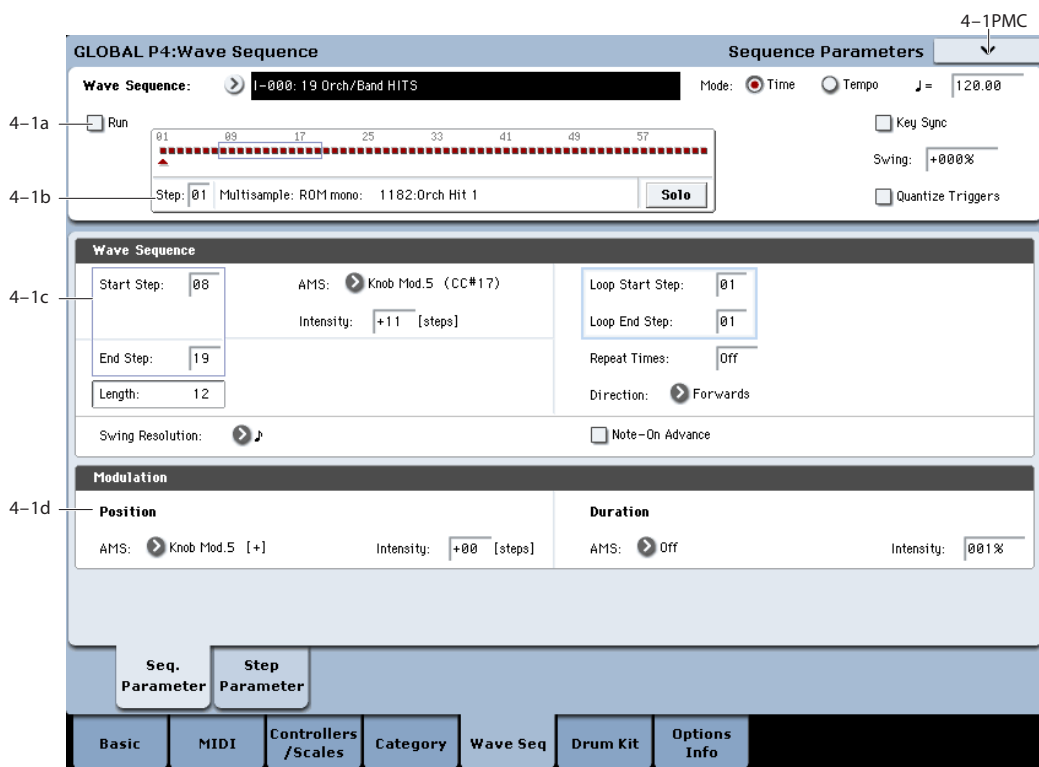

This page contains parameters for the selected Wave Sequence as a whole.

### 4-1a: Basic

#### Wave Sequence [I-000...149, U-A00...U-GG31]

The Wave Sequences in the Internal and U-A banks (I-000 through I-139, and U-A00 through U-A24) are the built-in “factory” sounds. You can over-write them if

you wish, but doing so may change the sounds of the factory Programs in banks INT-B...F and USER-A, and the Combinations in banks INT-A...D.

As shipped from the factory, U-B...G and U-AA...GG are empty user banks. You can use these for storing sounds that you create yourself, optional sound banks from Korg, or third-party sound libraries. Each User bank contains 32 Wave Sequences.

**Mode** [Time, Tempo]

This switches between **Time** mode (for crossfading Wave Sequences) and **Tempo** mode (for rhythmic Wave Sequences).

In **Time** mode, step durations are specified in milliseconds, and are not affected by the system tempo.

In **Tempo** mode, step durations are specified in rhythmic values, and are synchronized to the system tempo.

Each step stores separate values for the two modes, so that you can switch back and forth without losing any data.

Crossfade times are always specified in milliseconds, regardless of the **Mode** setting.

**♩ = (Tempo)** [040.00...300.00 BPM]

This is the current system tempo.

If the Global mode **MIDI Clock** parameter is set to **Internal**, you can adjust the tempo directly from this parameter, as well as using the Tap Tempo button or the Tempo knob.

If **MIDI Clock** is set to **External**, this will simply display "EXT."

- ▶ The **Tempo** parameter on this page affects the way that the Wave Sequence plays back during editing, but is not stored with the Wave Sequence itself. Instead, each Program, Combi, and Song has its own stored tempo.

**Run** [Off, On]

When this is **On**, the Wave Sequence will move through its steps automatically, according to the Duration and Crossfade settings for each step.

When this is **Off**, the Wave Sequence will not move from step to step automatically, and the steps' Duration and Crossfade settings will be ignored. You can then:

- Use Position Modulation to sweep through the steps manually
- Use Note-On Advance to increment the step with each new note
- Use Start Step AMS to play a different step with each note, modulated by velocity or other AMS sources

**Key Sync** [On, Off]

**On (checked):** When Key Sync is On, each note's Wave Sequence(s) will progress independently, so that each one can be on a different step, or moving at a different rate.

**Off (unchecked):** When Key Sync is Off, all of the Wave Sequences will be synchronized on the same step. There is one exception to this, however: if Duration is modulated with velocity or note-number, the Wave Sequences can still progress at different rates.

- ▶ The **Key Sync** parameter on this page affects the way that the Wave Sequence plays back during editing, but is not stored with the Wave Sequence

itself. Instead, each Program, each Combi Timbre, and each Track in a Song has its own **Key Sync** setting.

**Swing** [-300%...+000...+300%]

This parameter applies only when the **Mode** is set to **Tempo**.

Use **Swing** to add a sense of swing to the rhythm. For example, Swing provides an easy way to turn a "square" rhythm into a shuffle groove.

Swing adjusts the position of the up-beats, relative to the Wave Sequence's Resolution setting. For instance, if the Resolution is set to 1/8, Swing affects every other 8th note.

When Swing is set to **+100%**, these notes will be moved one third of the way toward the next down-beat. If the Resolution is 1/8, for example, +100% changes straight 8th notes into 8th note triplets.

When Swing is set to **+300%**, up-beats will be moved all the way to the next down-beat. At this point, the notes on the up-beats will not be heard at all.

Positive values make the up-beats later, and negative values make them earlier.

- ▶ The **Swing** parameter on this page affects the way that the Wave Sequence plays back during editing, but is not stored with the Wave Sequence itself. Instead, each Program, each Combi Timbre, and each Track in a Song has its own **Swing** setting.

*Wave Sequence Swing*

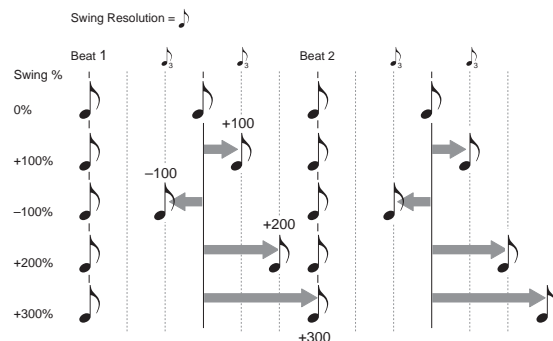

**Quantize Triggers** [Off, On]

This parameter applies only when the **Mode** is set to **Tempo**.

It allows you to force most Tempo-mode Wave Sequence note-ons to be in sync, making it easier to play along with other rhythmic elements.

When **Quantize Triggers** is **On**, note-ons are quantized to 8th notes using the current tempo reference. (See below for a few more details.)

The tempo reference can come from different sources, depending on the current mode, and whether or not KARMA is on:

- In Program and Combi modes, if KARMA is off, note-ons are synchronized with the sounding Tempo-mode Wave Sequence, if any.
- In Program and Combi modes, if KARMA is on, note-ons are synchronized with KARMA.
- In Sequencer mode during playback or recording, note-ons are synchronized with the sequence.



- In Sequencer mode, while the sequencer is stopped, note-ons are synchronized with RPPR and KARMA.

**On (checked):** Note-ons will be quantized.

**Off (unchecked):** Note-ons will be played instantly, the moment that you play the keyboard.

- 🔍 The **Quantize Triggers** parameter on this page affects the way that the Wave Sequence plays back during editing, but is not stored with the Wave Sequence itself. Instead, each Program, each Combi Timbre, and each Track in a Song has its own **Quantize Triggers** setting.

### How Quantize Triggers works

The **Quantize Triggers** feature tries to make a good guess at where you intended the note to be. If you play the note just a bit late—within a 32nd note of the 8th note—it will assume that you meant the note to sound on the beat that just passed. In this case, the note will play immediately.

On the other hand, if you play the note up to three 32nd notes early, it will assume that you're intending the note to sound on the next beat. In this case, the note-on is delayed until the next 8th note.

*Quantize Triggers*

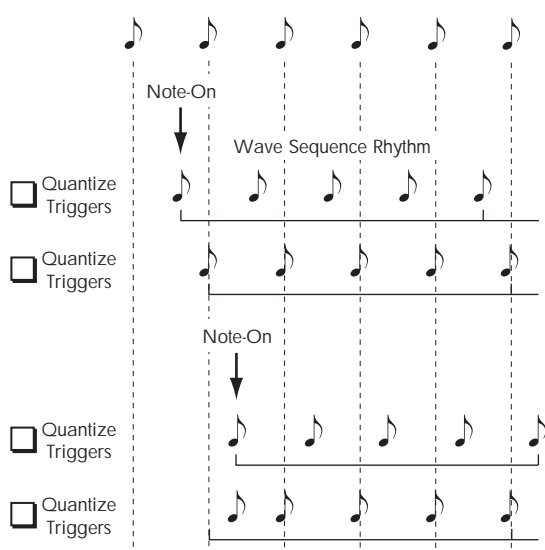

### 4-1b: Graphic

The graphic gives you a visual overview of the Wave Sequence:

- The current step is marked by a red arrow.
- Red boxes are Multisample steps.
- Green boxes are Tie steps.
- White boxes are Rest steps.
- The length of the Wave Sequence, from the Start Step to the End Step, is shown by a rectangular outline.
- The Loop is highlighted in blue.

**Step** [1...64]

This selects the current step. This is convenient when setting the Start, End, Loop Start, or Loop End steps.

**Multisample (Read-Only)** [Bank, Number, and Name]

This shows the bank, number, and name of the current step's Multisample.

**Solo** [Off, On]

This button solos the current step, so that you can hear it quickly and easily. When **Solo** is **On**, the Wave Sequence will play only the current step, including the fade-in and fade-out.

### 4-1c: Wave Sequence

**Start Step** [1...64]

This is the step on which the Wave Sequence starts. You can modulate this via AMS.

**Note:** When **Note-On Advance** is **On**, **Start Step** modulation is disabled. For more information, see "Note-On Advance" on page 790.

**AMS** [List of AMS Sources]

This selects a modulation source to control the Start Step. For a list of AMS sources, see "Alternate Modulation Source (AMS) List" on page 1091.

**Intensity** [-63...+63]

This controls the depth and direction of the Start Step modulation. Negative modulation moves the Start Step earlier in the sequence, to the limit of Step 1. Positive modulation moves the Start Step later in the sequence, to the limit of the End Step.

**End Step** [1...64]

This sets the number of steps in the Wave Sequence.

**Length (Read Only)** [1...64]

This read-only display shows the total number of steps in the Wave Sequence, based on the **Start Step** and **End Step**.

**Swing Resolution** [♩<sup>3</sup>...]

This sets the resolution which will be used for swing. If a Program contains multiple Wave Sequences with different **Swing Resolution** settings, the Program will use the finest value. For instance, if one Wave Sequence is set to 1/8 and the other is set to 1/16, the Program will use 1/16.

While the resolution is stored in the Wave Sequence, the swing amount is set in the Program, Combi Timbre, or Song Track. This lets you use a single Wave Sequence in different Programs, Combis, and Songs, each with different amounts of swing.

### Loop Parameters

Wave Sequences can loop, so that some or all of the steps are played repeatedly—like a drum loop, or a loop in a sequencer.

You can set the start and end of the loop separately from the start and end of the Wave Sequence itself. The loop can either play for as long as the note is played, or repeat a specified number of times. Finally, you can choose whether the loop plays forwards, plays backwards, or alternates between backwards and forwards.

**Loop Start Step** [1...64]

This is the step on which the loop starts.

**Loop End Step** [1...64]

This is the step on which the loop ends. It must be after the Loop Start.

**Direction** [Forwards, Backwards/Forwards, Backwards]

This sets the direction in which the loop is played.

Forwards plays from the Start Step to the Loop End, and then skips back to the Loop Start.

Backwards/Forwards plays from the Start Step to the Loop End, then backwards from the Loop End to the Loop Start, and then forwards again to the Loop End, and so on.

Backwards plays from the Start Step to the Loop End, then backwards from the Loop End to the Loop Start, and then skips back to the Loop End, and so on.

For instance, let's say that **Repeat Times** is set to **1**, **Loop Start** is set to **2**, and **Loop End** is set to **4**. In this case, the different **Loop Directions** work as shown below. The loop itself is shown in **bold italic type**.

Forwards: 1, 2, 3, 4, **2, 3, 4**, 5, 6.

Backwards: 1, 2, 3, **4, 3, 2**, 5, 6.

Backwards/Forwards: 1, 2, 3, 4, **3, 2, 3, 4**, 5, 6.

**Repeat Times** [Off, 1...127, INF]

This sets how many times the loop is repeated.

**OFF** means that the **Loop Start**, **Loop End**, and **Loop Direction** parameters have no effect. The Wave Sequence will play from the **Start Step** to the **End Step**, and then stay at the **End Step** for the remainder of the note.

When this is set between **1** and **127**, the loop will repeat the specified number of times. Once the repeats have finished, it will play through to the **End Step**, and then stay there for the remainder of the note.

**INF** means that the loop will repeat continuously for the duration of the note.

**Note-On Advance** [Off, On]

This parameter lets you advance the start point of the Wave Sequence by one step with each new note-on. If **Repeat Times** is not set to **Off**, this will step through the loop, paying attention to the loop direction and number of repeats.

For instance, let's say that the Wave Sequence **Start Step** is **2**, and the **End Step** is **6**. Also, the **Loop Start** is set to **3**, the **Loop End** is set to **5**, and the **Loop Direction** is set to **Forward**.

If **Repeat Times** is **Off**, **Note-On Advance** will make the Wave Sequence play as follows:

1st note: 2, 3, 4, 5, 6

2nd note: 3, 4, 5, 6

3rd note: 4, 5, 6

4th note: 5, 6

5th note: 6

6th note: 2, 3, 4, 5, 6

7th note: 3, 4, 5, 6

8th note: 4, 5, 6

9th note: 5, 6

10th note: 6

11th note: 2, 3, 4, 5, 6

etc...

If **Repeat Times** is **1**, **Note-On Advance** will make the Wave Sequence play as follows:

first note: 2, 3, 4, 5, 3, 4, 5, 6

2nd note: 3, 4, 5, 3, 4, 5, 6

3rd note: 4, 5, 3, 4, 5, 6

4th note: 5, 3, 4, 5, 6

5th note: 3, 4, 5, 6

6th note: 4, 5, 6

7th note: 5, 6

8th note: 6

9th note: 2, 3, 4, 5, 3, 4, 5, 6

10th note: 3, 4, 5, 3, 4, 5, 6

11th note: 4, 5, 3, 4, 5, 6

12th note: 5, 3, 4, 5, 6

13th note: 3, 4, 5, 6

14th note: 4, 5, 6

15th note: 5, 6

etc...

Finally, if **Repeat Times** is **1**, **Note-On Advance** will make the Wave Sequence play as follows. Note that the Wave Sequence never returns to the start step, since it's outside of the loop:

first note: 2, 3, 4, 5, 3, 4, 5, 3, 4, 5, 3, 4, 5...

2nd note: 3, 4, 5, 3, 4, 5, 3, 4, 5, 3, 4, 5...

3rd note: 4, 5, 3, 4, 5, 3, 4, 5, 3, 4, 5...

4th note: 5, 3, 4, 5, 3, 4, 5, 3, 4, 5...

5th note: 3, 4, 5, 3, 4, 5, 3, 4, 5...

6th note: 4, 5, 3, 4, 5, 3, 4, 5...

7th note: 5, 3, 4, 5, 3, 4, 5...

8th note: 3, 4, 5, 3, 4, 5...

9th note: 4, 5, 3, 4, 5, 3, 4, 5...

10th note: 5, 3, 4, 5, 3, 4, 5...

etc...

**Note:** When **Note-On Advance** is **On**, **Start Step** modulation is disabled.

**Note-On Advance and Key Sync**

**Note-On Advance** is also affected by the setting of the **Key Sync** parameter.

If **Key Sync** is **On**, the start point will advance by one step for each note.

If **Key Sync** is **Off**, the start point will advance by one step for each new phrase. For more information, see "Key Sync," on page 788.

---

## 4-1d: Modulation

### Position

#### AMS [List of AMS Sources]

This selects a modulation source to offset the Wave Sequence from its current position. The Wave Sequence will continue to progress through its steps during position modulation. To sweep through a sequence manually, set "Run," above, to **Off**.

If Position AMS changes by a large value over a small amount of time, it will skip intermediate steps if necessary.

For a list of AMS sources, see "Alternate Modulation Source (AMS) List" on page 1091.

#### Intensity [-63...+63]

This controls the depth and direction of the Position modulation. Negative modulation moves the position earlier in the sequence, to the limit of Step 1. Positive modulation moves the position later in the sequence, to the limit of the End Step.

### Position modulation and loops

Position AMS affects only the current step, and does not change the loop start or loop end. This means that Position AMS can make the Wave Sequence jump into the middle of the loop, or jump back out of the loop again.

### Duration

#### AMS [List of AMS Sources]

This selects a modulation source to control the step duration and crossfade times. You can speed up or slow down the Wave Sequence so that it runs between 1% and 400% of the original rate. This can be very useful for making a cross-faded Wave Sequence sound more organic.

For a list of AMS sources, see "Alternate Modulation Source (AMS) List" on page 1091.

#### Intensity [1...400%]

This controls the amount of Duration modulation.

**1%** means that, at the maximum AMS value, step durations and crossfade times will be 100 times shorter than their programmed settings.

**400%** means that, at the maximum AMS value, step durations and crossfade times will be four times longer than their programmed settings.

Put another way, values **99%** and lower make the Wave Sequence go faster, and values **101%** and higher make it go slower.

---

## ▼ 4-1: Page Menu Commands

The number before each command shows its ENTER + number-key shortcut. For more information on these shortcuts, see "ENTER + 0-9: shortcuts for menu commands" on page 147.

- **0: Write Wave Sequence.** For more information, see "Write Wave Sequence" on page 813.

## 4-2: Per-Step Parameters

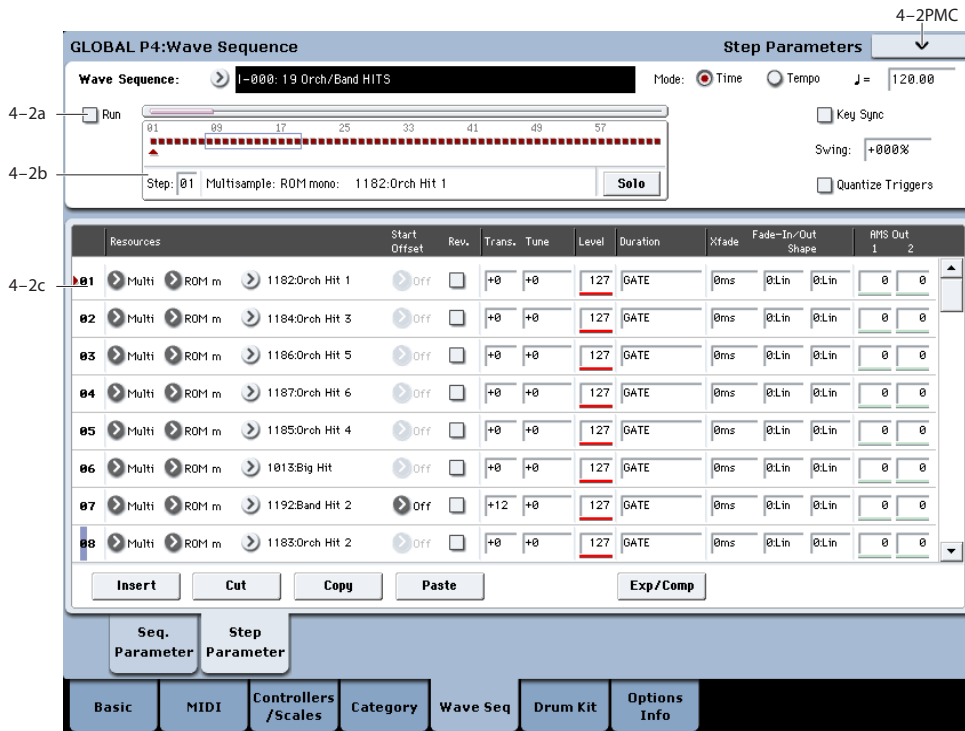

### 4-2a: Basic

#### Wave Sequence [I-000...149, U-A00...U-GG31]

This is the bank, number, and name of the current Wave Sequence. For more information, please see “Wave Sequence,” on page 787.

#### Mode [Time, Tempo]

This switches between **Time** mode (for evolving, crossfaded Wave Sequences) and **Tempo** mode (for rhythmic Wave Sequences). For more information, please see “Mode,” on page 788.

#### J = (Tempo) [040.00...300.00 BPM]

This is the current system tempo. For more information, please see “Tempo,” on 788.

#### Run [Off, On]

This determines whether or not the Wave Sequence will move through its steps automatically. For more information, please see “Run,” on page 788.

#### Key Sync [On, Off]

This determines whether each note will play its Wave Sequence separately (**Key Sync On**), or whether all of the notes will play together (**Key Sync Off**). For more information, please see “Key Sync,” on page 788.

#### Swing [-300%...+000...+300%]

Swing adjusts the position of the up-beats, relative to the Wave Sequence’s Resolution setting. This parameter applies only when the **Mode** is set to **Tempo**.

For more information, please see “Swing,” on page 788.

#### Quantize Triggers [Off, On]

This parameter allows you to force most Tempo-mode Wave Sequence note-ons to be in sync, making it easier to play along with other rhythmic elements. It applies only when the **Mode** is set to **Tempo**. For more information, please see “Quantize Triggers,” on page 788.

### 4-2b: Graphic

The graphic gives you a visual overview of the Wave Sequence. There’s one addition from the graphic shown on the other page: a scroll-bar over the top of the graphic shows the 8 currently displayed steps.

For more information, please see “4-1b: Graphic,” on page 789.

#### Step [1...64]

This selects the current step, which applies to the Cut, Copy, Paste, and Insert commands.

#### Multisample (Read-Only) [Bank, Number, and Name]

This shows the bank, number, and name of the current step’s Multisample.

#### Solo [Off, On]

This button solos the current step, so that you can hear it quickly and easily. When **Solo** is **On**, the Wave Sequence will play only the current step, as if **Run** were **Off**.

## 4-2c: Step parameters

This list shows the parameters for eight steps at a time. Use the scroll bar at the right of the screen to change which steps are in view.

### Type [Multisample, Rest, Tie]

This sets the step to one of three basic types.

**Multisample** means that the step will sound a new Multisample, as set by the **Multisample Select** parameter, below.

**Rest** means that the step will be silent.

**Tie** is an alternate way of creating rhythmic values, which may sometimes be more convenient than using the Base Note and x (Multiply Base Note By) parameters. Steps set to **Tie** simply extend the duration of the previous step; all parameters other than **Duration**, **Crossfade**, and **Fade-Out Shape** will be grayed out.

Additionally, the **Crossfade** and **Fade-Out Shape** settings of the previous step have no effect.

### Multisample Select [List]

This menu selects the step's Multisample.

 Some Multisamples may have an upper limit to their keyboard range, above which they may not produce any sound.

### Bank (Multisample) [List of Multisample Banks]

There are four types of Multisample Banks: **ROM**, **Sampling Mode**, **EXs**, and **User Sample Banks**.

**ROM** Multisamples are the built-in "factory" sounds, and are always available.

**Smp (Sampling Mode)** Multisamples are the ones that you can see and edit in Sampling Mode. After the abbreviation "Smp," several different things may appear, as described below.

**Smp: Old RAM** means that this is an older Program pointing to the legacy "RAM" bank. Instead of pointing to a specific User Sample Bank, it will use whatever Multisample data is loaded into Sampling Mode. Updating to the new format is easy; for more information, see "Converting older sounds" on page 155 of the Operation Guide.

**Smp: New Sampling Session** will appear when there's data in Sampling Mode which hasn't yet been saved to disk as a User Sample Bank. For instance, this might happen if you've loaded an old KSC file, loaded individual Samples or Multisamples, or recorded some new samples. Once the KSC is saved to disk, the name will update to show the file path (as described below).

**Smp: [file name]** will appear when a User Sample Bank has been loaded into Sampling Mode. The name is the file name itself along with those of all its enclosing folders.

**EXs** Multisample banks are PCM expansion sets created especially for the KRONOS. Each has its own unique number; for instance, the ROM Expansion is EXs1, and the Concert Grand Piano expansion is EXs2. Only the currently loaded EXs banks will appear on this menu.

**User Sample Banks** bring the benefits of EXs to your own sample libraries. You can load and play gigabytes of your custom or converted samples at once, using Virtual Memory. The name is shown as a path to the KSC file, including the file name and the names of all enclosing directories. Only the currently loaded User Sample Banks will appear in this menu.

If a sound refers to a User Sample Bank which is not on the internal drive(s), the name will appear as "Unknown Sample Bank [number]" when the bank select dialog is open, shortened to "??[number]" when the dialog is closed.

For more information, see "User Sample Banks" on page 154 of the Operation Guide.

### Start Offset [Off, 1st...8th]

In addition to simply starting playback from the beginning, ROM and EXs Multisamples can have up to 8 different pre-programmed alternate starting points, called Start Offsets.

Similarly, Sampling Mode and User Sample Bank Multisamples can play either from the beginning of the waveform, or from the loop start point.

### Start Offsets: ROM and EXs

With ROM and EXs Multisamples, the Start Offset specifies whether to use the normal start point (**Off**), or to use one of the alternate start points (**1st-8th**).

Some ROM and EXs Multisamples may have fewer than 8 pre-programmed points, in which case only the available points can be selected.

### Start Offsets: Sampling Mode and User Sample Banks

With Sampling Mode and User Sample Bank Multisamples, only **Off** and **1st** are available. **Off** uses the normal start point, and **1st** uses the loop start instead. **2nd** through **8th** will be grayed out.

### Rev. (Reverse) [Off, On]

This lets you play the selected Multisample backwards, without looping.

**Note:** If the individual samples within the Multisample are already set to Reverse, they will still play in reverse, regardless of this setting.

**On (checked):** The Multisample will play back in reverse.

**Off (unchecked):** The Multisample will play back normally.

### Trans. (Transpose) [+/- 24 semitones]

This controls the step's coarse tuning, in semitones.

### Tune [+/- 1200 cents]

This sets the step's fine tuning, in cents (1/100 of a semitone).

### Level [0-127]

This sets the volume level for the step.

### Duration: Mode = Time

The format for setting the Duration will be different depending on whether the Wave Sequence **Mode** is set to **Time** or **Tempo**.

**Duration** [0ms...10 sec, GATE]

This sets the duration of the step, in milliseconds or seconds. In Time mode, the duration is not affected by the system tempo.

When set to **GATE**, the sequence pauses at the step until note-off, and then the sequence continues. Multiple steps can be set to **GATE**, for modulation via Start Step AMS, Position AMS, or Note-On Advance.

**Duration: Mode = Tempo**

In this mode, the Wave Sequence synchronizes to the system tempo, as set by either the Tempo knob or MIDI Clock. The step durations are controlled by the **Base Note** and **Multiply** parameters, below

**(Base Note)** [♪... GATE]

This sets the basic duration of the step, relative to the system tempo. The values range from a 32nd note to a whole note, including triplets.

**GATE** works the same as in Time mode.

**x (Multiply Base Note by...)** [01...32]

This multiplies the length of the Base Note. For instance, if the Base Note is set to a sixteenth note, and Times is set to 3, the step's duration will be a dotted eighth note.

**Xfade** [0ms...10 sec]

This determines the time it takes to fade into the *next* step. For example, Step 1's Crossfade determines the time to fade between Step 1 and Step 2.

Crossfades use millisecond units for both **Time** and **Tempo** modes.

*Note:* In **Time** mode, the **Xfade** time cannot exceed the total duration of the two steps being crossfaded; in **Tempo** mode, it cannot exceed twice the duration of the shorter of the two steps.

The **Fade-In** and **Fade-Out Shape** parameters, below, allow linear, equal-power, and custom crossfades.

**Fade-Out Shape** [Off, Log, -126...-1, Linear, +1...126, Exp]

This sets the shape for the first step's fade-out within the crossfade.

**Off** means that the step will continue to sound at full volume for the full duration of the crossfade, and then cut off abruptly.

**Log** means that the step will fade out slowly at first, and then move more rapidly as it approaches the end of the crossfade. You can create an equal-power crossfade by using this shape for both the fade-out of one step and the fade-in of the next step.

**Linear** means that the step will fade out steadily, at a constant rate, over the duration of the crossfade.

**Exp** means that the step will fade out quickly at first, and then fade out more slowly as it nears the end of the crossfade.

**Fade-In Shape** [Off, Log, -126...-1, Linear, +1...126, Exp]

This sets the shape for the second step's fade-in within the crossfade.

**Off** means that the step will start to sound at full volume at the very beginning of the crossfade.

**Log** means that the step will fade in quickly at first, and then move more slowly as it nears the end of the crossfade.

**Linear** means that the step will fade in steadily over the duration of the crossfade.

**Exp** means that the step will fade in slowly at first, and then moved more rapidly as it nears end of the crossfade.

**AMS Output 1** [0...127]

Sets the step's first AMS output. You can use this as a modulation source for any AMS destination—for instance, to change the filter cutoff or pan position for each step. For more information, see "Modulating Program parameters per step" on page 170 of the Operation Guide.

**AMS Output 2** [0...127]

This sets the step's second AMS output.

Wave Sequence step Durations, Crossfade times, and Fade-In and Fade-Out shapes

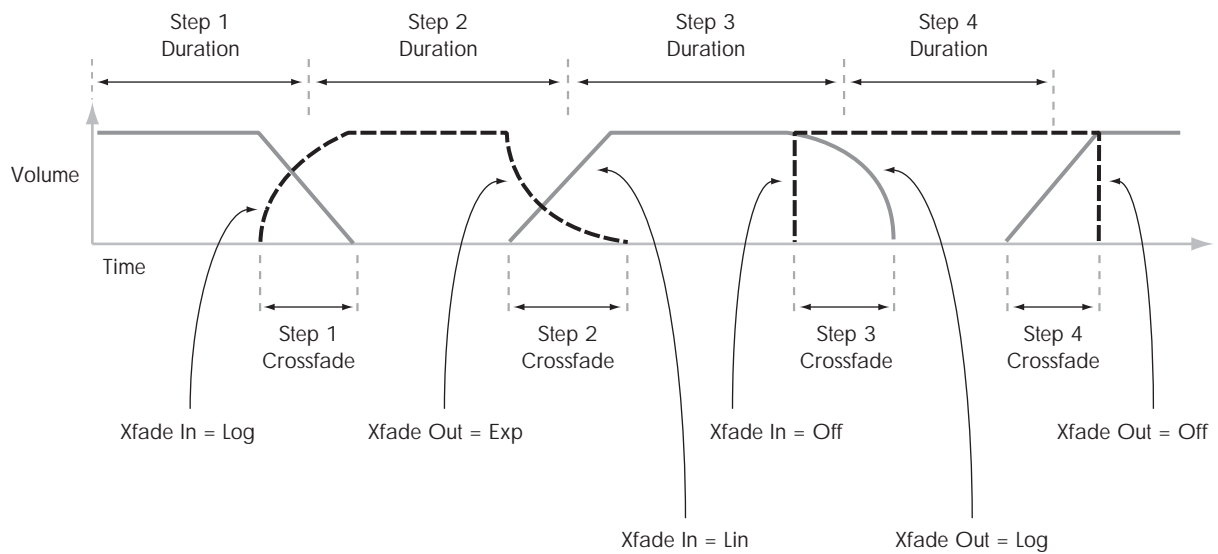

4-2d: Command buttons

Insert

This command inserts the previously Cut or Copied step before the current step.

Cut

This command removes the current step from the Wave Sequence, and moves the subsequent steps forward. The removed step can then be Pasted or Inserted into another location, if desired.

Copy

This command copies current step. You can then Paste or Insert the step into another location.

Paste

This command replaces the current step with the previously Cut or Copied step.

Exp/Comp (Mode = Time)

This command appears only when the Mode is set to Time. It brings up a dialog box, which allows you to expand or compress all of the duration and crossfade times by a specified percentage.

Duration Time dialog box

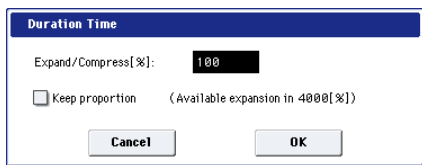

Expand/Compress [%] [0...100,000]

100% means the current duration and crossfade times. Values 99 and below make the times shorter, and values 101 and above make them longer.

/2 (Mode = Tempo)

This command appears only when the Mode is set to Tempo. It cuts the step durations and/or Multiply Base Note settings in half, so that 1/4 notes become 1/8 notes, 1/8 notes become 1/16 notes, and so on.

x2 (Mode = Tempo)

This command also appears only when the Mode is set to Tempo. It multiplies the step durations and/or Multiply Base Note settings by two, so that 1/8 notes become 1/4 notes, 1/4 notes become 1/2 notes, and so on.

▼ 4-2: Page Menu Commands

The number before each command shows its ENTER + number-key shortcut. For more information on these shortcuts, see "ENTER + 0-9: shortcuts for menu commands" on page 147.

- 0: Write Wave Sequence. For more information, see "Write Wave Sequence" on page 813.



## Global P5: Drum Kit

Drum Kits, as the name implies, are optimized for creating drum sounds. They are created and edited here in Global mode, and can then be used in HD-1 Programs. You can process them through the HD-1's filter, amp, drive, effects, and so on, similar to Multisamples or Wave Sequences.

For detailed step-by-step instructions on using and editing Drum Kits, please see "Using Drum Kits" on page 176 of the Operation Guide.

### Before editing Drum Kits

#### First, select a Drum Program

While you're in Global Mode, you'll play the kit that you're editing as if you were playing it from within the Program, Combi, or Song which was selected before you entered Global mode.

So, before you enter Global mode, it's best to select a Program which is already set up for drums, with the appropriate EG settings, effects, and so on. Just use the Program Category select popup, and choose a drum Program such as "Studio Standard Kit."

*Note:* If you select a Double Drums Program before entering Global mode, the Drum Kit from Oscillator 1 will be selected and ready for editing. When editing in Global mode, the selected Drum Kit will always play as if it were in the Program's Oscillator 1.

The Drum Kit in Oscillator 2 will continue to sound as well, although you can't edit it directly. You can control the volume balance between the two kits using the control surface, without leaving Global mode. To do so:

1. Press the CONTROL ASSIGN [TIMBRE/TRACK] button.

The Control Surface will then control the volumes of the two Oscillators.

2. Use the MIX VOLUMES [1]--[2] sliders to adjust the volumes of the drum kits.

#### OSC1/Basic Octave setting

In order for the note mappings to match the keyboard, the Oscillator's Octave setting needs to be +0 [8']. All Drum Kit Programs should have this setting already. If you're unsure, you can check this yourself:

1. Go to the OSC1/Basic tab of the OSC/Pitch page.
2. Check that the Octave parameter (near the top of the page) is set to +0 [8'].

With a setting other than +0 [8'], the relationship between the keys and the Drum Kit sound map will be incorrect.

#### Make sure that Memory Protect is disabled

Before you start editing, go to the Global Basic page, and look in the Memory Protect section. Make sure that **Drum Kit** is not checked—if so, you won't be able to make any edits.

#### Drum Kits may be used by more than one Program

When you edit a Drum Kit, all Programs that use that Drum Kit will be affected. To avoid changing the factory voicing, you may wish to copy Drum Kits to empty locations in the USER banks before editing.

- ⚠ If you turn off the power or select another drum kit before writing, your edits cannot be recovered. To save your edits, use the **Write Drum Kit** page menu command or press the SEQUENCER REC/WRITE switch to open the Update Drum Kit dialog box.

- 🎹 If "Enable Exclusive" (1-1c) is checked, the drum kit can be edited via MIDI System Exclusive data.

## 5-1: Sample Setup

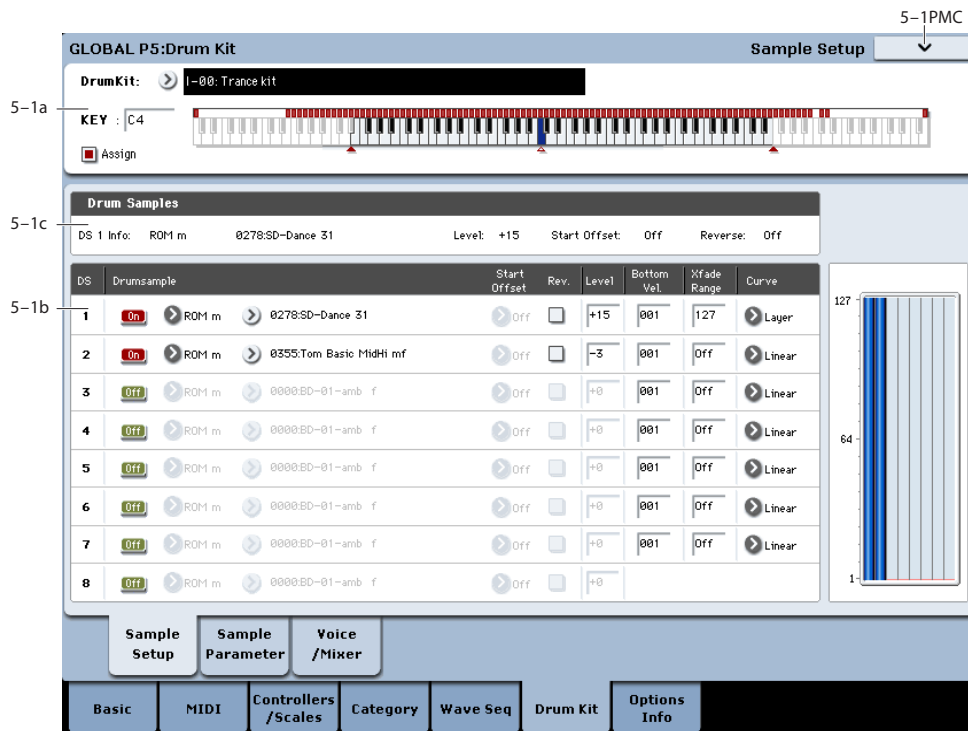

This page lets you assign sounds to each key in the Drum Kit. A single key is shown at a time. Each key can have up to 8 Drum Samples (DS1-8), and each DS has its own settings for start offset, reverse on/off, level, and velocity zone. For additional DS parameters, see “5-2: Sample Parameters” on page 800 and “5-3: Voice Assign/Mixer” on page 801.

For more information on Drum Kits, see “Using Drum Kits” on page 176 of the Operation Guide.

### 5-1a: Drum Kit, Key Select, Assign

**Drum Kit** [I-00...39, U-A...G 00...15, GM0...8, U-AA...GG 00...15]

Selects the Drum Kit that you wish to edit.

*Drum Kit bank contents*

Bank	Contents
INT-00...39, USER-A00...USER-C05	Factory Drum Kits
GM 0...8	GM2 Drum Kits
USER-C06...USER-G15 USER-AA00...USER-GG15	User Drum Kits

*Note:* GM0-GM8 are GM2-compatible preset Drum Kits. As with GM bank Programs, they can be edited but must be saved to a non-GM location.

**KEY** [C-1...G9]

Selects the key to which the drum sample (and its settings) will be assigned.

Use the VALUE controller to specify the key. You can also select the key by holding down the ENTER switch and playing a note on the keyboard. You can assign up to eight drum samples (DS1...8) to each key, and switch between them by velocity.

If you check **Assign** for the key you select here, the DS1...8, Voice Assign Mode, and Mixer parameters (see below) will be used.

**Assign** [Off, On]

**On (checked):** The drum samples you assigned for DS1-4 will sound. Normally you will check this parameter.

**Off (unchecked):** The selected drum samples will be invalid, and the drum samples of the key to the right will sound. At this time, the pitch will be a semitone lower than the pitch of the key to the right. Uncheck this parameter when you wish to play a drum sample at differing pitches.

### 5-1b: Drumsample

You can specify up to eight Drum Samples. The process is the same as for Multisample s in the HD-1. “Bottom Velocity” and “Xfade Range” specify the velocity zones for each of the Drum Samples.

#### DS1 (Drum Sample1):

These are the settings for the highest velocity zone.

If you want to create a simple setup using only one drum sample, without velocity switching, use only DS1, and set its “Bottom Velocity” to 1 and “Xfade Range” to Off. Then, make sure that DS2...8 are all turned off.

Drum Kit, Key Select, Assign

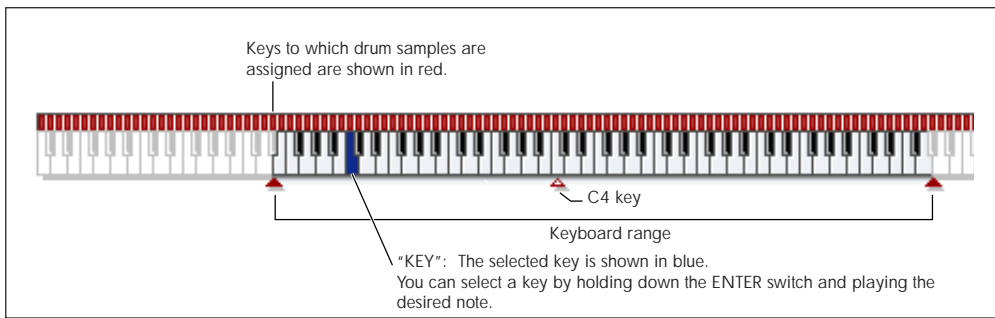

To use two or more velocity switches or crossfades, start with DS1 and work downwards. For instance, for a three-way velocity switch, use DS1...3.

**On** DS1 On/Off [Off, On]

**On (checked):** Check this if you want to use DS1 (High). The selected drum sample will sound.

**Off (unchecked):** DS1 (High) will not be used. The drum sample will not sound.

**Bank** [List of Multisample Banks]

**Drumsample Select** [000...416, 0000...15999, 000...]

This lets you select a Drum Sample for DS1.

There are four types of Multisample Banks: **ROM, Sampling Mode, EXs,** and **User Sample Banks.** For each type, you can also choose between looking at mono and stereo Drum Samples. Note that stereo Drum Samples will require twice as many voices as mono Multisamples.

**ROM:** These are the KRONOS's standard Drum Samples.

**Smp (Sampling Mode)** Samples are the ones that you can see and edit in Sampling Mode. After the abbreviation "Smp," several different things may appear, as described below.

**Smp: Old RAM** means that this is an older Drum Kit pointing to the legacy "RAM" bank. Instead of pointing to a specific User Sample Bank, it will use whatever Sample data is loaded into Sampling Mode. Updating to the new format is easy; for more information, see "Converting older sounds" on page 155 of the Operation Guide.

**Smp: New Sampling Session** will appear when there's data in Sampling Mode which hasn't yet been saved to disk as a User Sample Bank. For instance, this might happen if you've loaded an old KSC file, loaded individual Samples or Multisamples, or recorded some new samples. Once the KSC is saved to disk, the name will update to show the file path (as described below).

**Smp: [file name]** will appear when a User Sample Bank has been loaded into Sampling Mode. The name is the file name itself along with those of all its enclosing folders.

**EXs:** These are the KRONOS's EXs drum samples. The number of drum samples will differ depending on the EXs. The KRONOS ships with 9 EXs banks. Note that some EXs banks may not contain drum samples.

**ROM/EXs mono and stereo**

When you press the "Drumsample Select" popup button a drum sample list will appear, allowing you to choose drum samples from the list.

Use the tabs to choose a category, and then choose a drum sample from within the category. Press the OK button to execute, or press the Cancel button to cancel.

It is not possible to edit the category names of drum samples, or to re-assign the category.

**ROM Mono and EXs Mono:** Mono drum samples will be displayed. The individual left and right channels of ROM and EXs stereo drum samples can also be selected as mono drum samples. In these cases, -L or -R is shown following the drum sample name.

**ROM Stereo and EXs Stereo:** Only stereo drum samples will be displayed.

**Sampling Mode and User Sample Bank mono and stereo**

Use the tabs to select a group of one thousand, and then choose a Sample within that group. Press the OK button to execute, or press the Cancel button to cancel.

**Mono:** Mono drum samples will be displayed. The L-channel or R-channel of stereo drum samples can also be selected as mono drum samples. In these cases, -L or -R is shown following the drum sample of the same name.

**Stereo:** Only stereo drum samples will be displayed, using the same numbers and names as the mono samples. The same stereo sample will be specified regardless of whether you select -L or -R.

**Start Offset** [Off, 1st...8th]

In addition to simply starting playback from the beginning, ROM and EXs Drum Samples can have up to 8 different pre-programmed alternate starting points. Similarly, Sampling Mode and User Sample Bank Drum Samples can play either from the beginning of the waveform, or from the loop start point.

With ROM and EXs Drum Samples, the Start Offset specifies whether to use the normal start point (**Off**), or to use one of the alternate start points (**1st-8th**).

Some ROM and EXs Drum Samples may have fewer than 8 pre-programmed points, in which case only the available points can be selected.

With Sampling Mode and User Sample Bank Drum Samples, only **Off** and **1st** are available. **Off** uses the normal start point, and **1st** uses the loop start instead. **2nd** through **8th** will be grayed out.

**Reverse** [Off, On]

This lets you play the selected drum sample backwards, without looping.

**On (checked):** The drum sample will play back in reverse.

The location at which reverse playback starts and ends is already specified for each drum sample. In the case of RAM bank samples whose "Start" and "End" (Sampling 2-1d) are specified, the sample will play (backward) from "End" to "Start."

**Off (unchecked):** The drum sample will play back normally.

 This parameter will not change the playback direction of a sample for which "Reverse" (Sampling 2-1d) is checked.

**Level (Amp Level)** [-99...+99]

Specifies the volume.

Keys for which a value of **+99** is specified will sound at a volume twice as high as the amp level of the program which uses that drum kit. Keys for which a value of **0** is specified will sound at the volume of the amp level of the program which uses that drum kit.

Keys for which a value of **-99** is specified will not sound.

**Bottom Velocity** [1...127]

This sets the lowest velocity at which the drum sample will sound. DS1's Bottom Velocity can be equal to, but not lower than, than that of DS2.

**Xfade Range** [Off, 1...127]

This specifies the velocity range starting at "Bottom Velocity" over which DS1 will fade-out and DS2 will fade-in.

For instance, if the Bottom Velocity is set to 64, and the Xfade Range is set to 20, DS2 will start to fade in at velocities of 84 and below.

When velocities are within the Xfade Range, the Oscillator will use twice as much polyphony as it would normally.

*Note:* You can only fade between two zones at once.

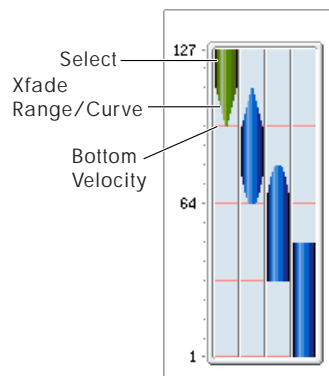

**Curve** [Linear, Power, Layer]

This controls the volume curve of the crossfade. **Linear** and **Power** (short for Equal Power) let you fine-tune the way that the two drum samples mix together; one or the other may be more appropriate for a given pair of drum samples. **Layer**, true to its name, lets you layer the two drum samples together without any crossfading.

**Linear** means that the two samples will each be at 50% of their full volume in the middle of the crossfade. Sometimes, this may create a dip in the volume level; if so, try using **Power** instead.

**Power**, short for Equal Power, means that the two samples will each be at around 70% of their full volume in the middle of the crossfade. Sometimes, this may create a bump in the volume level, in which case you might try selecting **Linear** instead.

**Layer** means that the two drum samples will be layered together, both at full volume, for the entire range of the crossfade.

*Crossfade Curves*

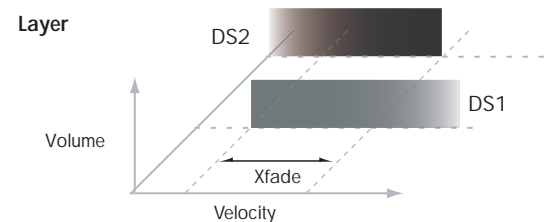
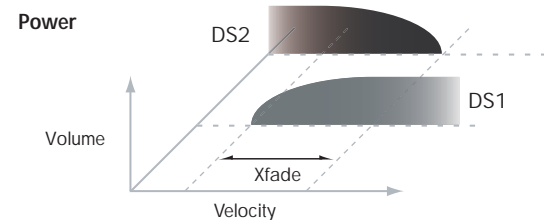
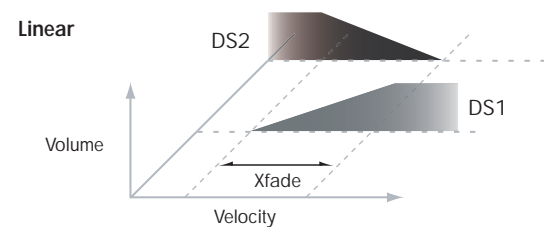

**DS2...7 and DS8**

These are the settings for the remaining velocity zones. The parameters for DS2...7 are exactly the same as those for DS1, as described above.

The parameters for DS8 are also similar to those for DS1, except that DS8 has no settings for Bottom Velocity (which is always fixed at 1), Xfade Range, or Curve.

### ▼ 5-1: Page Menu Commands

The number before each command shows its ENTER + number-key shortcut. For more information on these shortcuts, see “ENTER + 0-9: shortcuts for menu commands” on page 147.

- **0: Write Drum Kit.** For more information, see “Write Drum Kit” on page 813.
- **1: Copy Key Setup.** For more information, see “Copy Key Setup” on page 814.
- **2: Swap Key Setup.** For more information, see “Swap Key Setup” on page 814.

## 5-2: Sample Parameters

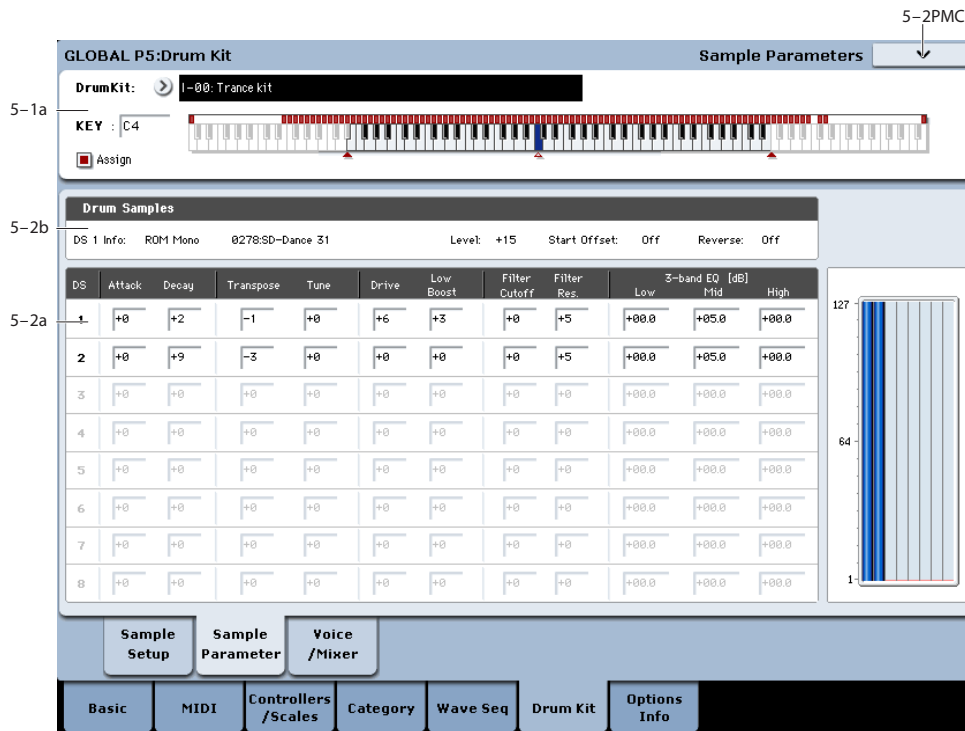

Here you can edit the attack and decay, tuning, filter cutoff and resonance, and three-band EQ settings for each drum sample. These settings are offsets that are applied to the settings of the program.

### 5-2a: Drumsample Parameters

#### DS1 (High): (Drum Sample 1 High)

**DS1(High) On/Off** [Off, On]

**On (checked):** Check this if you want to use DS1 (High). The selected drum sample will sound.

**Off (unchecked):** DS1 (High) will not be used. The drum sample will not sound.

**Attack (Amp EG Attack)** [-64...+63]

Adjusts the attack time of the volume (Amplifier). The attack time for each key is determined by adding this value to the amp EG Attack Time of the Program that uses this drum kit.

**Decay (Amp EG Decay)** [-64...+63]

Adjusts the decay time of the volume (Amplifier). The decay time for each key is determined by adding this value to the amp EG Decay Time of the Program that uses this drum kit.

**Transpose** [-64...+63]

Adjusts the pitch in semitone steps.  
+12 is one octave up, and -12 is one octave down.

**Tune** [-99...+99]

This adjusts the pitch in cents, over a range of ±1 octave. A cent is 1/100 of a semitone.

**Drive** [-99...+99]

This adjusts the drive level. This offset value for each key and drum sample is applied to the driver “Drive” (Program 4-1a) setting of the programs that use this drum kit.

**Low Boost (Driver Low Boost)** [-99...+99]

This adjusts the low boost level of the driver. This low boost setting for each key and drum sample is applied to the driver “Low Boost” (Program 4-1a) setting of the programs that use this drum kit.

**Filter Cutoff** [-64...+63]

Adjust the cutoff frequency of the filter. The cutoff frequency for each key and drum sample is determined by adding this value to the filter **Frequency** (Program 3-1b) of the program that uses this drum kit.

**Resonance (Filter Resonance)** [-64...+63]

This adjusts the filter resonance. This offset value for each key and drum sample is applied to the filter "Resonance" (Program 3-1b) of the programs that use this drum kit.

**3 Band Parametric EQ [dB]****Low** [-36.0...+36.0]**Mid** [-36.0...+36.0]**High** [-36.0...+36.0]

These parameters adjust the gain for each band of the three-band parametric EQ. The gain settings for each key and drum sample are applied to the "Low Gain," "Mid Gain," and "High Gain" (Program 4-9a) settings of the programs that use this drum kit.

**DS2...7 and DS8(Low)**

These are the parameters for the remaining drum samples. The parameters are the same as those of DS1, as described above.

**▼ 5-2: Page Menu Commands**

The number before each command shows its ENTER + number-key shortcut. For more information on these shortcuts, see "ENTER + 0-9: shortcuts for menu commands" on page 147.

- 0: **Write Drum Kit**. For more information, see "Write Drum Kit" on page 813.
- 1: **Copy Key Setup**. For more information, see "Copy Key Setup" on page 814.
- 2: **Swap Key Setup**. For more information, see "Swap Key Setup" on page 814.

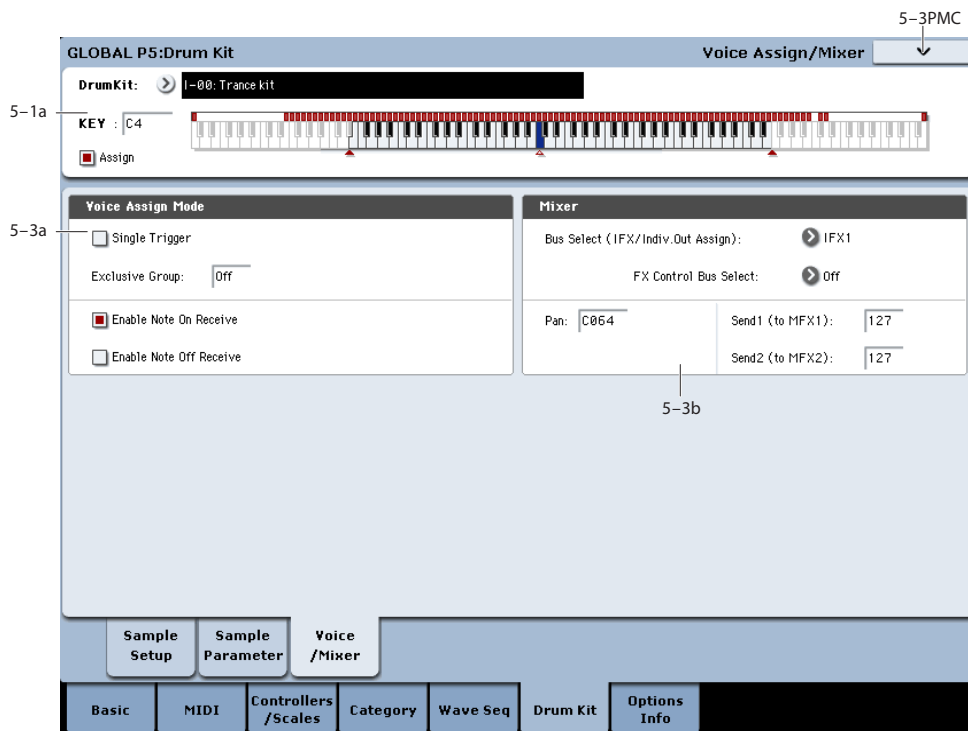
**5-3: Voice Assign/Mixer**

Specify the voice assign, pan, and effect routing etc. for each key of the drum kit.

**5-3a: Voice Assign Mode****Single Trigger** [Off, On]

**On (checked):** Even when the same key (note) is played repeatedly, the previous note will be halted before the new note is begun, so that the notes will not overlap. Normally you will leave this unchecked.

**Exclusive Group (Exclusive Assign)** [Off, 001...127]

**001-127:** This allows you to assign keys to any of 127 groups. Keys assigned to the same group will be treated as a single group, and will be played

monophonically with last-note priority. For example you might assign closed and open hi-hat sounds to the same group so that two or more hi-hat sounds can not sound simultaneously.

**Off:** Keys will not be grouped. This is the default setting.

**Enable Note On Receive** [Off, On]

**On (checked):** Note-on messages will be received. Normally you will check this, but you can uncheck it if you do not want specific notes to sound.

**Enable Note Off Receive** [Off, On]

**On (checked):** Note-off messages will be received. Normally you will uncheck this. This parameter is valid when "Hold" (Program 1-1d) is checked (Hold



On). In the case of a drum program, you will normally select Hold On. In this case if “Enable Note Off Receive” is checked, note-off messages will be received, and the sound will stop (the release segment of the EG will begin) when the key is released.

**5-3b: Mixer**

▶ Drum kits will sound using the settings of the program that is selected in Program mode. **Pan** is valid if “Use DKit Setting” (Program 4-1c) is checked. **Bus Select**, **FX Control Bus**, and “Send 1/2” are valid if “Use DKit Setting” (Program 8-1b) is checked. Be aware that while editing a drum kit, the edited results will not be reflected unless these settings have been made.

**Bus Select (IFX/Indiv.Out Assign)**  
[L/R, IFX1...12, 1...4, 1/2...3/4, Off]

For each key, you can specify the bus to which the sound will be sent.

For example, you might send Snare sounds to IFX1 and Kick sounds to IFX2 to apply separate insert effects, and send the remaining sounds to L/R without applying insert effects.

*Tip:* In most of the preloaded drum kits, the following types of drum instrument have the same **Bus Select** settings.

*Tip:* Most of the preloaded drum kits use the same basic **Bus Select** settings, as shown below:

- Snares → IFX1
- Kicks → IFX2
- Toms → IFX3
- Cymbals → IFX4
- Percussion etc. → IFX5

**FX Control Bus** [Off, 1, 2]

For each key, you can select whether the signal will be sent to FX Control bus (stereo two-channel) FX Ctrl1 or 2.

Normally you will leave this off, but you can use this setting if you want to control an effect by playing a specific key.

You can use this with the following effects:

Vocoders:

- 026: Vocoder

Compressor and gate-type effects:

- 002: Stereo Compressor
- 003: Stereo Expander
- 005: Stereo Limiter
- 009: Stereo Gate
- 010: Stereo Noise Reduction

*Example: Gated Reverb*

This is an example of applying a gated reverb to only a specific snare sound. When using a gate effect on reverb, you may not be able to control the gating timing correctly if you use the extended reverberant sound to control the gate. Normally, you will control the gate using sound from before reverb is applied.

For the key for which you’ve selected the snare sample, set **Bus Select** to IFX6. Also use **FX Control Bus Select** to send the signal to FX Control Bus 1. In IFX7: Stereo Gate, choose FX Control 1 as the Envelope Source. Now you can use a signal other than the input (reverberant sound) to control the gate.

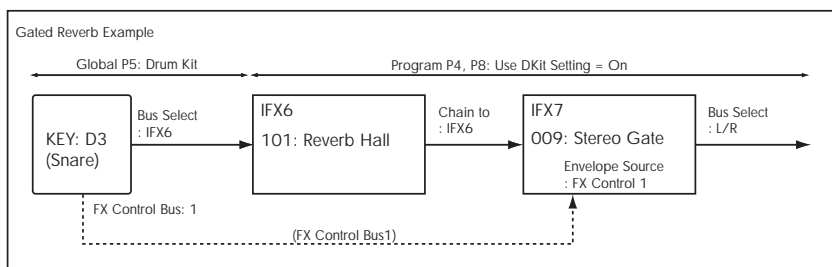

**Pan** [Random, L001...C064...R127]

Specifies the panning for each key.

L001 places the sound at far left, and R127 places the signal at far right. With a setting of **Random**, the drum sample will be panned randomly at each note-on.

**Send1 (to MFX1)** [000...127]

**Send2 (to MFX2)** [000...127]

For each key, specify the send levels to master effects 1 and 2.

These settings are valid when **Bus Select** (5-3b) is set to L/R or Off. If **Bus Select** is set to IFX1-12, the send level to master effects 1 and 2 will be determined by the Program, Combination, or Sequencer mode P8: Insert FX page parameters **Send1** and **Send2** which are located after the sound passes through IFX1-12.

▼ **5-3: Page Menu Commands**

The number before each command shows its ENTER + number-key shortcut. For more information on these shortcuts, see “ENTER + 0-9: shortcuts for menu commands” on page 147.

- 0: **Write Drum Kit**. For more information, see “Write Drum Kit” on page 813.
- 1: **Copy Key Setup**. For more information, see “Copy Key Setup” on page 814.
- 2: **Swap Key Setup**. For more information, see “Swap Key Setup” on page 814.



## Global P6: Options Info

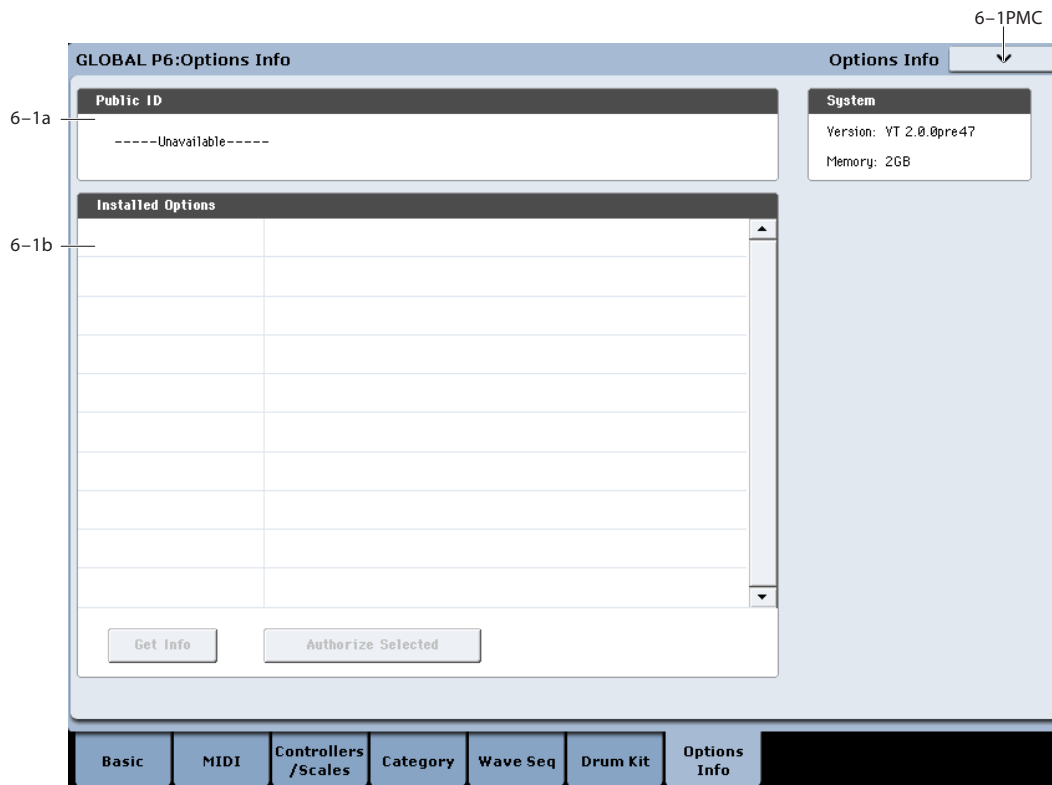

This page lets you manage any installed options. Here, you can:

- View information on all installed options and option bundles
- Authorize options with codes purchased from [www.korg.com/kronos](http://www.korg.com/kronos), or from your Korg distributor

### 6-1a: Public ID

**Public ID** [nn nn nn nn nn nn nn nn]

This is a unique identifier, like a very specific name; it is different for each and every KRONOS. The Public ID is 16 characters long, and uses only the characters 0-9 and A-F. You'll need this ID when registering on [www.korg.com](http://www.korg.com), which is required for purchasing options.

### 6-1b: Installed Options

This section shows all of the installed options or option bundles, and whether they are authorized or in demo mode.

Some options may be bundles which include multiple titles. In this case, the list will show the name of the bundle only. To see all of the titles included in the bundle, select the bundle in the list and press the **Get Info** button.

**Demo** options are installed on the system, but have not yet been purchased and authorized. When an option is in demo mode, you can play, edit, and save Programs, Combinations, and Songs which use it—but until you

purchase and enter an authorization code, any sound which uses the option will fade out periodically. For more information, see "Authorizing options," below.

**Authorized** options are fully functional. Some options may already be authorized by default.

#### Get Info button

Pressing the Get Info button calls up a window containing information for the selected option or option bundle. For instance, it shows all individual titles within an option bundle.

#### Authorize Selected button

Once you've purchased an authorization code, select the option from the list, and press this button to enter the code into the KRONOS. For more information, see "Authorizing options," below.

### Installing EXs

EXs sample data is installed in Disk mode. For more information, see "Install EXs" on page 855.

### Uninstalling EXs

The **Uninstall EXs** menu command lets you remove optional EXs to reclaim space on the internal disk(s). For more information, see "Uninstall EXs" on page 814.

## Authorizing options

Authorizing KRONOS options is simple. First, you'll purchase an authorization code; then, you'll enter it on this page. To do so:

1. **Write down the Public ID. Make sure that you've copied it accurately.**
2. **If you have access to the internet, follow the instructions under "Purchasing option licenses via the internet," below.**  
**or:**  
**If you do not have internet access, follow the instructions under "Purchasing option licenses from your Korg distributor," below.**

### Purchasing option licenses via the internet

1. **Go to <http://www.korg.com/kronos>**
2. **Log in under your registered member name.**

If you aren't already registered, follow the online instructions for registering as a member of [www.korg.com](http://www.korg.com). After registering as a member, register your KRONOS.

3. **Purchase the authorization code for the desired option.**

After purchasing, you'll receive your authorization code. Note that this code is tied to your Public ID, and will not work on other KRONOS systems. If you have more than one KRONOS, you'll need to purchase authorizations for each one separately.

4. **Once you have the authorization code, follow the instructions under "Authorizing options on the KRONOS," below.**

### Purchasing option licenses from your Korg distributor

If you do not have access to the internet, your national Korg distributor will be happy to assist you in purchasing option authorization codes.

1. **Write down your KRONOS Public ID.**
2. **Contact your Korg distributor, and ask them for assistance with purchasing option authorizations for KRONOS.**

You can find contact information for your Korg distributor by contacting your Korg dealer, or from the following page on the Korg website:

<http://www.korg.co.jp/English/index.html>

3. **After you purchase the authorization code(s), proceed to "Authorizing options on the KRONOS," below.**

### Authorizing options on the KRONOS

1. **Go to the Global Options Info page.**
2. **Select the option to authorize from the list of Installed Options.**
3. **Press the Authorize Selected button.**

The Authorize Selected window will appear. You'll see the name of the selected option or option bundle at the top of the window. The window also includes an on-screen keyboard, so that you can enter your authorization code.

4. **Enter the authorization code.**

5. **Press OK.**

Provided that you entered a valid authorization code, the list will now show the option or option bundle as **Authorized**, and the audio limitations of **Demo** mode will be removed.

---

## ▼ 6-1: Page Menu Commands

The number before each command shows its ENTER + number-key shortcut. For more information on these shortcuts, see “ENTER + 0-9: shortcuts for menu commands” on page 147.

- **0: Write Global Setting.** For more information, see “Write Global Setting” on page 806.
- **1: Uninstall EXs.** For more information, see “Uninstall EXs” on page 814.

## Global: Page Menu Commands

### Write Global Setting

This command writes most of the Global mode settings, except for the following:

- Drum Kits
- Wave Sequences
- Memory Protect settings
- System Clock setting
- KSC Auto-Load settings

To write Drum Kits or Wave Sequences, see:

- “Write Drum Kit” on page 813
- “Write Wave Sequence” on page 813

1. Select Write Global Setting to open the dialog box.

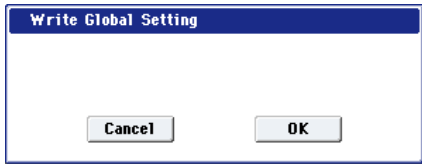

2. To write the data, press the OK button. To cancel without writing, press the Cancel button.

You can also use the SEQUENCER REC/WRITE switch to write data in the same way as the **Write Global Setting** command.

Press the SEQUENCER REC/WRITE switch to access the **Update Global Setting** dialog box, and press the OK button to write the data.

- ⚠ Do not turn off the power for at least 10 seconds after using the **Write Global Setting** command. This allows the system time to complete the process, which includes saving a backup of the data to the internal disk.

### Set Program User-Bank Type

This command lets you do two related things:

- Set the bank types of Program banks USER-A...G and AA...GG to either HD-1 or EXi
- Initialize banks of Programs

When you execute this command, the Programs within the specified banks will be initialized to Programs of the selected bank type.

Note that bank types are set automatically when loading Program banks from disk; you don't need to use this command first.

- ⚠ Before you use this command, make sure that Memory Protect is disabled for Programs (see “0-1e: Memory Protect” on page 758). Otherwise, the message “Memory Protected” will appear after you press OK, and no changes will be made.

1. Choose “Set Program User-Bank Type” to open the dialog box.

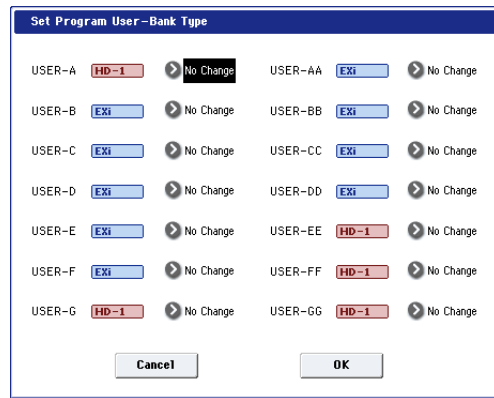

This indicates the current type for each user bank.

2. Specify the bank type for each bank.

**No Change:** The bank type will not be changed, and the bank's Program data will remain unchanged.

**HD-1:** The bank type will be set to HD-1, and all of the bank's Programs will be initialized.

**EXi:** The bank type will be set to EXi, and all of the bank's Programs will be initialized.

*Note:* If a bank is set to anything other than No Change, all data in that bank will be initialized – even if you have specified the same bank type as before. If you want to keep your data, you must first use **Save All** or **Save PCG** to save it.

3. Press the OK button to execute, or press the Cancel button to cancel. A dialog box will ask you to confirm the operation.

4. Verify the settings. Then press the OK button to execute, or press the Cancel button to cancel.

## Change all bank references

This command changes all program banks specified for timbres in combinations or tracks of songs.

1. Select "Change all bank references" to open the dialog box.

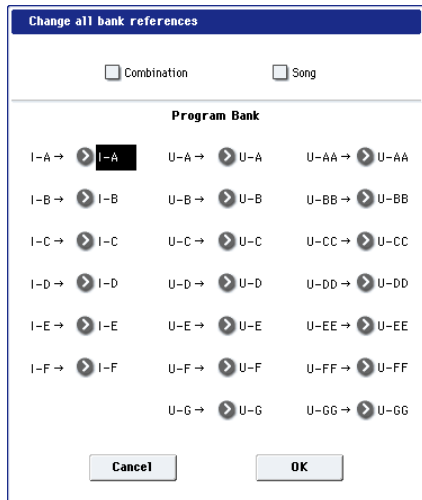

2. If you wish to change bank references for combinations, check "Combination."  
If you wish to change bank references for songs, check Song.
3. In "Program Bank," specify the replacement for each bank.
4. To execute the Change All Bank References command, press the OK button. To cancel, press the Cancel button.

 If you change two or more different banks to the same bank, it will not be possible to use this function to change them back to different banks. Be careful that the change destination banks do not overlap.

## Touch Panel Calibration

If input via the LCD screen does not work as you expect, or if the edit cell moves to a location other than where you pressed the LCD screen, use this command to adjust the sensitivity of the LCD screen.

1. Select "Touch Panel Calibration" to open the dialog box.



2. If you are unable to select this command from the page menu, go to the main Global page as normal, and then hold down the ENTER button and press 3 on the numeric keypad. This will call up the calibration dialog.
3. Press the square in the upper left of the LCD. When your touch has been detected correctly the square will be highlighted.
4. Press the square in the lower right of the LCD. When your touch has been detected correctly the square will be highlighted.
5. Press the Done button.  
If your touch was not detected correctly, an error message will appear. Please perform the procedure once again.

## Half Damper Calibration

If a damper pedal that supports half damper (the DS-1H option) is connected to the DAMPER jack, here's how you can adjust the sensitivity if the damper effect is not applied appropriately.

 Since the half-damper pedal is highly sensitive, please use the optional DS-1H. Other pedals may not produce the appropriate effect, or may be impossible to calibrate correctly.

1. Connect a half-damper pedal to the DAMPER jack.
2. On the Global P2: Controller page, make sure that the Damper Polarity is set correctly.
3. Select "Half Damper Calibration" to open the dialog box.

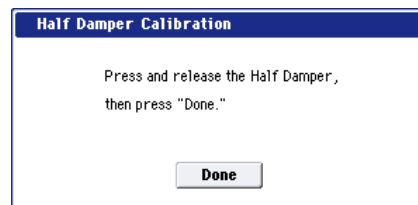

4. Press the half-damper pedal, and then release your foot from the pedal.
5. Press the Done button.  
If the adjustment could not be performed correctly, an error message will be displayed. Please perform the procedure once again.

## After Touch Calibration

This allows you to adjust the aftertouch sensitivity of the keyboard hardware.

When the KRONOS is shipped from the factory, the aftertouch sensitivity is adjusted to a standard value. In normal use, you won't need to change this; instead, we recommend using the After Touch Curve (see "After Touch Curve" on page 754) to adjust the response to your taste.

However, you may customize the aftertouch sensitivity as described below. For instance, you might do this if you want the aftertouch to be a bit lighter.

1. **To ensure correct calibration, play the keyboard from the same position as when you're actually performing.**
2. **Slowly depress any note and verify that the bar indicator moves from left to right.**

*Note:* This sensitivity setting applies to the keyboard as a whole, and cannot be adjusted separately for individual keys.

3. **Release the note before the bar reaches the right edge, to match the amount of pressure at which you want the maximum aftertouch effect to occur.**
4. **Press the Done button.**

If the adjustment could not be made correctly, an error message will appear. Perform the adjustment once again. If you want to restore the original setting, do the following:

1. **Slowly depress any note until the bar indicator moves all the way to the right edge.**
2. **Press the Done button.**

## LCD Setup

This lets you adjust the brightness of the LCD screen.

1. **Choose LCD Setup to open the dialog box.**

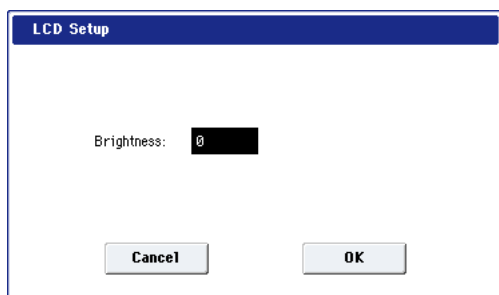

2. **Adjust the Brightness as desired.**  
Brightness: 0...63 (63 is the default)  
Adjusts the brightness of the display's backlight.
3. **To finish the LCD Setup, press the OK button. To cancel without making changes, press the Cancel button.**

## Update System Software

 Before you start the update process, back up important data on external USB storage media.

1. **Using a computer, download the update from the Korg website: [www.korg.com/kronos](http://www.korg.com/kronos).**

The update will be in compressed, zip format.

2. **Un-zip the downloaded file.**

Un-zipping will result in a folder containing several different files and at least one sub-folder, with names such as:

```
install.info
mnt (folder)
posttar.sh
pretar.sh
Update[number].tar.gz
```

Files may have different names, and there may also be additional files. Note that some file names may end with "tar.gz" or "tgz;" this is normal, and these files are ready for use by the installer without need for further un-zipping.

*Note:* Depending on your browser settings, the downloaded file may be unzipped automatically, creating the files and folders described above.

3. **Follow any instructions included with the update.**
4. **Open the folder from step 2, above.**
5. **From within this folder, copy all of the files and sub-folder(s) to the root level of a FAT32-formatted USB storage device, such as a USB flash drive.**

 Copy the files and sub-folders only; don't copy the main, enclosing folder.

 FAT32 format is required. Other formats, including NTFS (Windows) or HFS+ (Mac OS X), will not work. Most USB flash drives use FAT32 by default.

6. **Disconnect all USB devices from the KRONOS.**

Other USB devices may interfere with the update process.

7. **Go to the Global P0- Basic Setup page.**

To go to this page from any part of the system, press the GLOBAL button to enter Global mode, and press the EXIT switch up to four times. (This always takes you to the first page of the selected mode.)

8. **Open the menu, and select the command "Update System Software."**

A dialog will appear on the screen:

Connect the Software Update media, and press OK.

9. **Connect the USB storage device containing the update file(s), from step 5 above.**

10. **Press the OK button.**

A window will appear with the message "Searching for update files..."



If a valid update file is found, a new dialog will appear:

Found version [version number] updaters files

Press OK to install

11. **Press the OK button again.**

A message and progress bar will appear on the screen, noting that the system is being updated.

-  Do not disconnect the USB storage device while the update is in progress.
-  While the system is being updated, do not touch the KRONOS' switches, and never turn off the power. If the power is accidentally turned off while the system is being loaded, the KRONOS may become inoperable. If this occurs, using the Restore DVDs may be required; please contact your local Korg distributor.

When the update is complete, a new message will appear:

Update to KRONOS system version [nn] complete.  
Please turn off the power, wait a moment, and then turn on power again to use the new software.

**12. Turn off the KRONOS, and then disconnect the USB storage device.**

**13. Wait approximately ten seconds, and then turn the power on again.**

The system version number is shown on the startup screen, and also on the Global P6-Options Info page. Verify that it is correct.

### Error messages

If any problems occur, an error message will appear:

Error: the system update was not successful

If you see this error or encounter other difficulties, try the following:

- Make sure that all other USB devices are disconnected
- Make sure that you have copied all the files and sub-folders included with the update, as described in step 5 above
- Use a different, freshly-formatted USB storage device

---

## Display Public ID

The Public ID is a unique identifier, like a very specific name; it is different for each and every KRONOS. It's 16 characters long (not counting the dashes between each pair of characters), and uses only the characters 0-9 and A-F.

You'll need to know the instrument's Public ID when purchasing KRONOS software options, or if you have to re-authorize the KRONOS software.

This simple dialog displays the instrument's Public ID.

1. **Select Display Public ID to open the dialog box.**
2. **Write down the 16-character Public ID, as displayed on the screen.**
3. **Press OK to close the dialog box.**

---

## Dump Program

This command lets you send the internal memory's Program data as a System Exclusive data dump. You can choose to send all of the Programs from all of the banks, all of the Programs from a single bank, or a single Program.

For more information, see "System Exclusive Data Dumps" on page 810.

---

## Dump Combination

This command lets you send the internal memory's Combination data as a System Exclusive data dump. You can choose to send all of the Combinations from all of the banks, all of the Combinations from a single bank, or a single Combination.

For more information, see "System Exclusive Data Dumps" on page 810.

---

## Dump Drum Kit

This command lets you send the internal memory's Drum Kit data as a System Exclusive data dump. You can choose to send all of the Drum Kits from all of the banks, all of the Drum Kits from a single bank, or a single Drum Kit.

For more information, see "System Exclusive Data Dumps" on page 810.

---

## Dump Wave Sequence

This command lets you send the internal memory's Wave Sequence data as a System Exclusive data dump. You can choose to send all of the Wave Sequences from all of the banks, all of the Wave Sequences from a single bank, or a single Wave Sequence.

For more information, see "System Exclusive Data Dumps" on page 810.

---

## Dump Global Setting

This command lets you send the internal memory's Global Settings data as a System Exclusive data dump. For more information, see "System Exclusive Data Dumps" on page 810.

---

## Dump Sequencer

This command lets you send the internal memory's Sequencer data, including all Songs in memory, as a System Exclusive data dump.

For more information, see "System Exclusive Data Dumps" on page 810.

---

## Dump Set List

This command lets you send the internal memory's Set List data as a System Exclusive data dump. You can choose to send either all of the Set Lists, or a single Set List.

For more information, see "System Exclusive Data Dumps" on page 810.



### Dump Drum Track User Pattern

This command lets you send the internal memory's Drum Track User Pattern data as a System Exclusive data dump. You can choose to send either all of the Patterns, or a single Pattern.

For more information, see "System Exclusive Data Dumps" on page 810.

### Dump KARMA User GE

This command lets you send the internal memory's KARMA GE data as a System Exclusive data dump. You can send all GE data and templates, banks of GE data or templates, or individual GEs. For more information, see "System Exclusive Data Dumps," below.

### System Exclusive Data Dumps

These commands allow the KRONOS internal data to be transmitted to another KRONOS, MIDI data filter, or computer in the form of MIDI System Exclusive data.

*System Exclusive dump types*

Dump Program	All Programs, a specific bank of Programs, or a single Program
Dump Combination	All Combinations, a specific bank of Combinations, or a single Combination
Dump Drum Kit	All Drum Kits, a specific bank of Drum Kits, or a single Drum Kit
Dump Wave Sequence	All Wave Sequences, a specific bank of Wave Sequences, or a single Wave Sequence
Dump Global	Global settings (except for Drum Kits and Wave Sequences)
Dump Sequencer	All Song and Region data
Dump Set List	All Set Lists, or a single Set List
Dump Drum Track User Pattern	All Patterns, or a single Pattern
Dump KARMA User GE	All: Dump all user GEs and user templates. GE Bank: "All" will dump all user GEs, and USER-A...L will dump individual banks. GE Single: Dump an individual GE. User Template: Dump user templates used by user GEs. "All" will dump data for all four user templates, and USER-A...D will dump individual template banks.

### Sending SysEx data dumps

 Do not touch the KRONOS's switches or turn off the power while data is being transmitted.

1. **Connect the KRONOS to the device that will receive the data dump.**

If you're using a computer editor, connect the KRONOS USB B port to one of the computer's USB ports. You may need to wait briefly for the connection to be recognized.

Alternatively, if you're using a computer with a MIDI interface, connect the MIDI IN connector of

your computer's MIDI interface to the KRONOS MIDI OUT connector. Note that this will be much slower than using USB, as described above.

If you are using a MIDI data filer, connect the KRONOS's MIDI OUT connector to the MIDI IN connector of the MIDI data filer.

2. **Go to Global P1: MIDI.**
3. **Select the desired "dump" command from the menu (see the table "System Exclusive dump types," above).**
4. **Select the specific data to send. For example, all of that type, a single bank, or a single item.**
5. **Select whether to send the dump via MIDI or USB.** When using a computer, choose USB if possible.
6. **Press the OK button to transmit the data.**

While the data is being transmitted, the display will indicate "Now Transmitting MIDI Data."

The size of the data and the time required for transmission will depend on the type of data.

 When performing a data dump from the KRONOS onto a MIDI data filer, do not transmit multiple data dumps together. If multiple data is saved together, the KRONOS will have less than the required time (right column in the table above) to write the data into memory, and will be unable to receive all of the data correctly.

### Receiving SysEx data dumps

1. **Connect the KRONOS to the device which will send the data dump.**

If you are using a computer, connect the USB B port of the KRONOS to one of the computer's USB ports.

If you are using a MIDI data filer, connect the data filer's MIDI OUT to the KRONOS's MIDI IN.

2. **Set the KRONOS's global MIDI channel to match the channel used for the data dump.**

When the KRONOS sends a SysEx dump, the current global MIDI channel is embedded in the data. In order to receive the data, the KRONOS's global MIDI channel must be set so that it was the same as when the data was transmitted.

3. **Turn on the "Enable Exclusive" check-box in the MIDI Filter section of the Global P1: MIDI page.**
4. **Transmit the data from the other device. For the procedure, refer to the owner's manual for the device you are using.**

While the data is being received, the display will show the message "Now receiving MIDI data."

 Do not touch the KRONOS's switches or turn off the power while data is being received.

 Before receiving MIDI data, we recommend that you close any open dialog box or menu, with the exception of the Disk page menu command "Save Exclusive (Receive and Save MIDI System Exclusive Data)" dialog box.

 After a data dump is received, the KRONOS will require approximately one second to process the data and write it into memory. During this time, the display will show the message, "Now writing into internal memory." While this message is shown,

you must under no circumstances turn off the power of the KRONOS. If the power is turned off during this time, the KRONOS may fail to operate correctly when the power is turned on again.

Transmission and reception of MIDI data is also impossible during this time. When receiving multiple data dumps in succession, you must allow enough time between each data dump for the message to disappear from the screen.

**MIDI cannot be transmitted or received while data is being written into internal memory. Also, transmission of Active Sensing (FEh) from the MIDI OUT connector and USB connector will be halted.**

**Cautions when receiving Program data**

- When receiving a data dump for a bank or a single program, and the bank type of the received program is different, the message “Program Bank Type Conflicts” will appear, and the data will not be received. For banks USER–A...G and AA...GG, use the Global menu command **Set Program User-Bank Type** to specify the appropriate bank, and then receive the data again.
- When receiving an All Programs data dump, only bank data whose bank type matches will be received. If banks of a different bank type are received, the message “Program Bank Type Conflicts” will be displayed.

**Set Up KARMA External MIDI Routing**

When using KARMA in conjunction with an external sequencer, you can execute this command with the appropriate setting to automatically make settings for Global mode “Enable KARMA Module to MIDI Out,” “Enable MIDI In to KARMA Module,” and “Local Control On” (1–1a).

1. Choose “Setup KARMA External MIDI Routing” to open the dialog box.
2. Select the desired routing.

Send the output of KARMA to external device/sequencer

Choose this if you want the phrases generated by the KRONOS’s KARMA Module to be sent via MIDI to control your external MIDI device or to be recorded on your external MIDI sequencer.

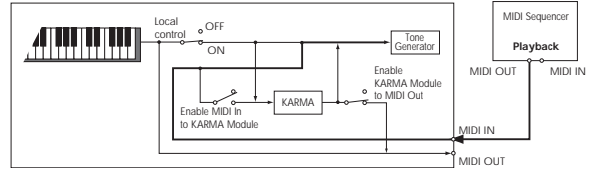
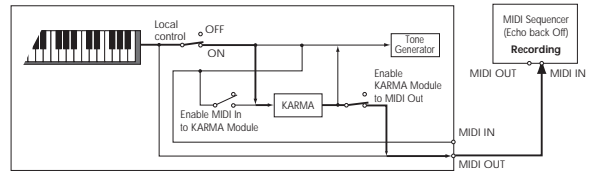
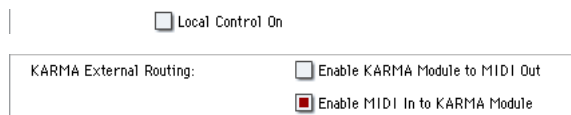
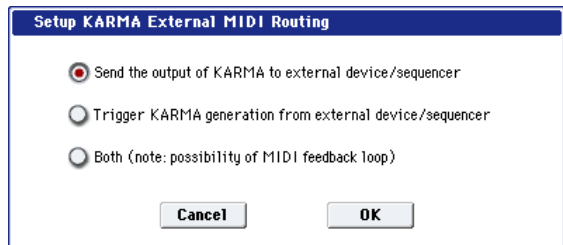

**Trigger KARMA generation from external device/sequencer**

Choose this if you want the KARMA Module to be triggered by MIDI input from an external MIDI device or MIDI sequencer.

You can also select this if you want only the KRONOS’s keyboard performance that triggers the KARMA Module to be sent as MIDI output and recorded on an external sequencer, and then use the echo-back or playback from the external sequencer etc. to trigger the KARMA Module.

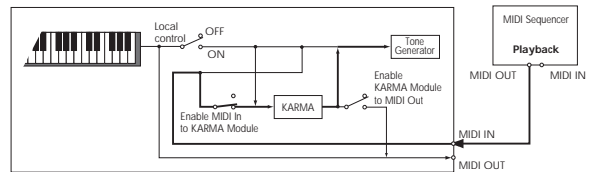
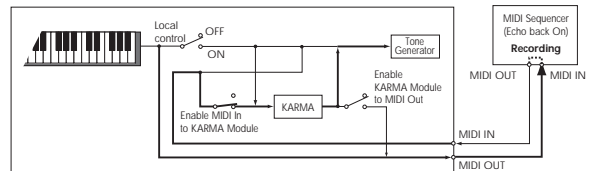
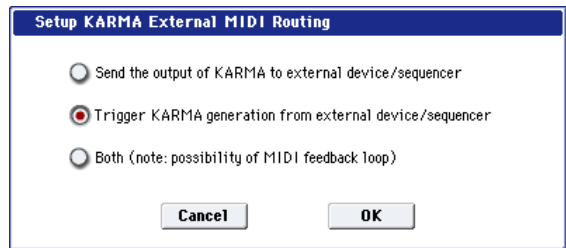

Both (note: possibility of MIDI feedback loop)

Choose this if you want to make both of the above settings.

Be aware that in some cases, the phrases generated by the KARMA Module will pass through the external MIDI device (MIDI sequencer) and re-trigger the KARMA Module – producing a MIDI feedback loop that may cause undesired operation. You will need to manage the MIDI signal routing to ensure that MIDI feedback does not occur, for example by disabling MIDI IN→OUT echo-back in your MIDI sequencer.

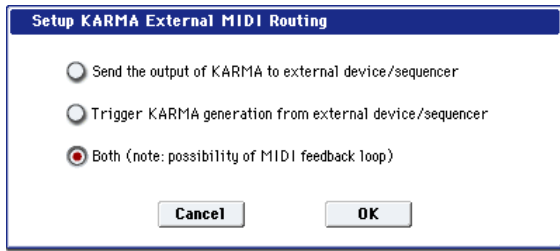

3. Press the OK button to execute the Setup KARMA External MIDI Routing command, or press the Cancel button to cancel.

### Reset External Setup

This command initializes the external controller settings.

All settings for Knob 1–8, Switch 1–16, Slider 1–8, Master Slider, and Pad 1–8 will be initialized for the selected setup number.

“Channel” = Gch

“Assign” = Off

Pad Only “Velocity” = 127

1. Select the setup number that you want to reset.
2. Choose Reset External Setup to open the dialog box.

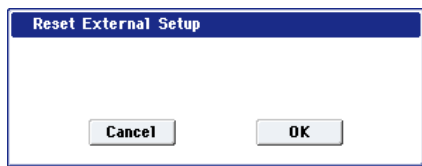

3. Press the OK button to execute Reset External Setup, or press the Cancel button to cancel.

### Reset Controller MIDI Assign

This command resets the MIDI control change (CC) assignments for the KARMA Sliders and Switches, the 8 pads, and the Vector Joystick. You can use this command to restore the standard settings, and then adjust any or all of the assignments manually, if you like.

For more information on these settings, see “2–1: Controllers” on page 781.

1. Choose “Reset Controller MIDI Assign” to open the dialog box.
2. Set the “To” field to the desired reset method.

**All Off:** All settings will be Off.

**Default Setting:** The KARMA controls and pads will all be set to Off; the Vector Joystick will be set to its default CCs.

**CC Default:** This sets up the recommended CCs for the pads and KARMA controls, as well as the Vector Joystick. The default values are shown in the table below.

If you want to record KARMA controllers in Sequencer mode, or use the controllers with external MIDI devices, we recommend using this setting.

(You are also free to assign different MIDI CCs to the controllers, if you wish.)

3. Press the OK button to execute the reset command, or press the Cancel button to cancel.

*Reset Controller MIDI Assign Default*

	KRONOS Controls	CC Default	Default Setting
KARMA	ON/OFF	CC#14	Off
	SCENE	CC#30	
	LATCH	CC#31	
KARMA Sliders	1	CC#22	
	2	CC#23	
	3	CC#24	
	4	CC#25	
	5	CC#26	
	6	CC#27	
	7	CC#28	
	8	CC#29	
KARMA Switches	1	CC#102	
	2	CC#103	
	3	CC#104	
	4	CC#105	
	5	CC#106	
	6	CC#107	
	7	CC#108	
	8	CC#109	
Pads	1	CC#110	
	2	CC#111	
	3	CC#112	
	4	CC#113	
	5	CC#114	
	6	CC#115	
	7	CC#116	
	8	CC#117	
Vector Joystick	VJS X	CC#118	CC#118
	VJS Y	CC#119	CC#119

### Copy Scale

This command copies data from a preset scale or between user scales. For details on the preset scales, refer to “Type” (Program 1–1e).

1. Select “Copy Scale” to open the dialog box.

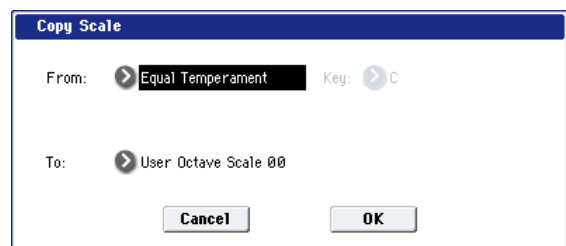

## 2. Use "From" to select the copy-source scale.

If you select Pure Major or Pure Minor, specify the "Key" (located at the right) as well.

Stretch cannot be selected if "To" is User All Notes Scale.

## 3. In "To," selects the copy destination scale.

## 4. To execute the Copy Scale command, press the OK button. To cancel, press the Cancel button.

## Write Wave Sequence

A dialog box for saving a wave sequence will appear. You can select a new location, and edit the name of the wave sequence.

You must write an edited wave sequence if you want to keep it. An edited wave sequence cannot be recovered if you turn off the power or select a different wave sequence before writing it.

### 1. Choose "Write Wave Sequence" to open the dialog box.

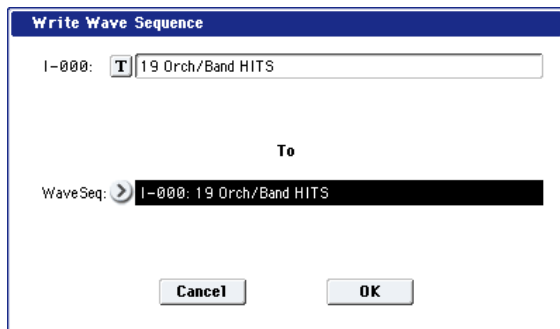

### 2. The upper line shows the wave sequence name. If you want to edit the wave sequence name, input the desired name in the text edit box.

### 3. Use the lower line "To Wave Sequence" to select the writing-destination.

You can also press the popup button and choose the writing-destination from the "Wave Sequence Select" menu. If you select the "Wave Sequence Select" menu, press the OK button to confirm or press the Cancel button to cancel your selection.

### 4. Press the OK button to execute the Write Wave Sequence command, or press the Cancel button to cancel without executing.

*Note:* You can also use the SEQUENCER REC/WRITE switch to write in the same way as the "Write Wave Sequence" command. Press the SEQUENCER REC/WRITE switch to access the Update Wave Sequence dialog box, and write the wave sequence. In this case, the data will be written to the currently selected wave sequence.

-  Do not turn off the power for at least 10 seconds after using the **Write Wave Sequence** command. This allows the system time to complete the process, which includes saving a backup of the data to the internal disk.

## Write Drum Kit

This command writes an edited drum kit into internal memory.

You must write an edited drum kit if you want to keep it. An edited drum kit cannot be recovered if you turn off the power or select a different drum kit before writing it.

### 1. Choose "Write Drum Kit" to open the dialog box.

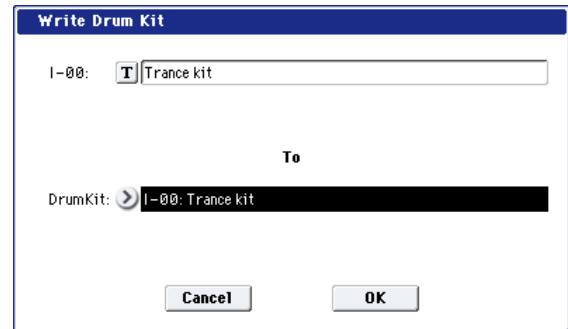

### 2. The upper line shows the drum kit name. If you want to edit the drum kit name, input the desired name in the text edit box.

### 3. Use the lower line "To Drum Kit" to select the writing-destination.

You can also press the popup button and choose the writing-destination from the "Drum Kit Select" menu. If you select the "Drum Kit Select" menu, press the OK button to confirm or press the Cancel button to cancel your selection.

*Note:* You can't write to GM0 through GM8. If you've edited one of the GM drum kits, you may write it to the INT or USER-A...GG banks.

### 4. Press the OK button to execute the Write Drum Kit command, or press the Cancel button to cancel without executing.

*Note:* You can also use the SEQUENCER REC/WRITE switch to write in the same way as the "Write Drum Kit" command. Press the SEQUENCER REC/WRITE switch to access the Update Drum Kit dialog box, and write the drum kit. In this case, the data will be written to the currently selected drum kit.

-  Do not turn off the power for at least 10 seconds after using the **Write Drum Kit** command. This allows the system time to complete the process, which includes saving a backup of the data to the internal disk.

## Copy Key Setup

This command copies the settings of an individual key to another key. You can also copy settings from two or more contiguous keys at once.

1. Select Copy Key Setup to open the dialog box.

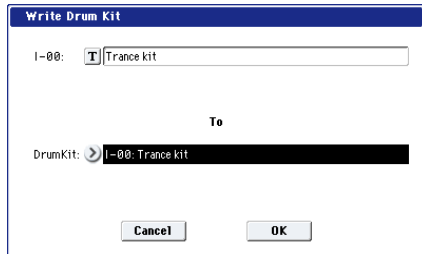

2. In "From Key," select the range of keys that you wish to copy.
3. In "To Key," select the copy destination key. If you selected two or more keys in "From Key," their settings will be copied to the keys starting at "To Key" and continuing upward.
4. To execute the Copy Key Setup command, press the OK button. To cancel, press the Cancel button.

## Swap Key Setup

This command exchanges (swaps) the settings of one key with the settings of another key.

1. Choose Swap Key Setup to open the dialog box.

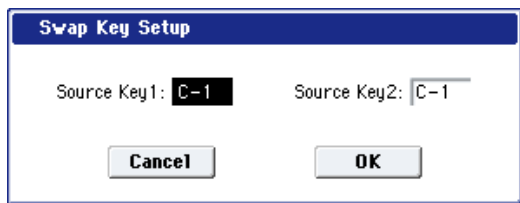

2. Use "Source1" and "Source2" to specify the keys whose settings you want to swap.
3. Press the OK button to execute the Swap Key Setup command, or press the Cancel button to cancel.

## Unload all in bank

This command lets you un-load an entire bank of sample data at once. To do so:

1. In the menu, select the Unload all in bank command.

The Unload all data from selected bank dialog will appear.

2. Select the desired bank (Sampling Mode, or any EXs or User Sample Bank).
3. Press the OK button to confirm, or Cancel to exit the dialog without making changes.

## Uninstall EXs

Optional EXs may be uninstalled to reclaim space on the internal disk(s). To do so:

1. Go to the Global P6: Options Info page.
2. In the list of Installed Options, select the EXs that you'd like to remove.
3. Select the Uninstall EXs command from the menu.

A dialog box will appear:

Uninstall [EXs name and number]

Delete all of the option's EXs Samples and Multisamples?

4. Press OK to continue.

Another dialog box will appear, showing that the uninstall is in progress. After the uninstall is complete, a third dialog box will appear:

[EXs name and number] sample data deleted.

Related PCG, KSC etc. may remain; delete manually if desired.

Only the EXs Multisamples and Drum Samples are removed from the disk. KSC and PCG files can be edited, and so they might contain your personal data; to avoid inadvertently affecting your data, these files are left untouched.

5. Press OK to continue.

6. If you like, delete the related PCG and KSC files manually in Disk mode.

⚠ Uninstall is available only for optional EXs10 and above. It does not apply to EXs1 through 9.

⚠ After uninstalling, any sounds which used the uninstalled EXs will no longer play correctly.

# Disk mode

Disk mode is where you can save data from internal memory to the internal disk or an external USB storage device, or load data from media into internal memory. You can also copy or delete files, or format media.

Finally, you can create audio CDs from WAVE files, using an external USB CD-R/RW drive.

In addition to the internal disk, KRONOS supports most USB storage devices, including:

- Hard disk drives
- Removable disk drives
- USB flash media
- CD-R/RW drives

With external drives and flash media, the KRONOS supports MS-DOS FAT16 and FAT32 disk formats. FAT 16 supports up to 4 GB; FAT 32 supports up to 2 Terabytes (2,000 GB).

## CD-R/RW

The KRONOS can read and write UDF format CD-R/RW disks. For more information, see “CD-R/RW disks on the KRONOS: UDF and packet-writing” on page 1153.

CD-DA (standard audio CDs) can be recorded and played, and ISO9660 (level 1) format can be read.

## DVD-ROM

The KRONOS can read (but not write) UDF format DVD-ROM disks.

---

## Files, directories, and icons

The KRONOS manages data on disks and other media in a hierarchical manner, using files and directories. The contents of a file (whether it is a file or a directory) are indicated not only by the name but also graphically by an icon. Files and directories have differently shaped icons.

The KRONOS collectively refers to files and directories recognizable by MS-DOS (readable by a MS-DOS computer), and UDF format and ISO9660 format files and directories as “DOS files” and “DOS directories.” Different types of DOS file are distinguished by the extension added to their filename.

In the case of a DOS file with an extension other than listed below, selecting “Load selected” to open the dialog box will cause the file to be considered to be a Standard MIDI File (SMF). However, in this case non-SMF files cannot be loaded

*File extensions and KRONOS data types.*

Extension	Type
.PCG	Program, combination, drum kit, wave sequence, global settings (KRONOS format)
.SNG	Songs and regions (KRONOS format)
.MID	Standard MIDI File (SMF)
.EXL	MIDI System Exclusive data
.KGE	KARMA Generated Effects file
.KMP	Korg Multisample Parameter file Songs and regions (KRONOS format)
.KSF	Korg Sample File (Korg format)
.KSC	Korg Sample Collection file (Korg format)
.AIF	AIFF file
.WAV	WAVE file
.SYX	DX-format System Exclusive files
.KCD	Audio CD track list (KRONOS format)
.KFX	Effect preset (KRONOS format)
.exsins	EXs installer file

When KRONOS data is saved, one of these filename extensions will be added automatically, according to the type of data. If these filename extensions are modified on a computer, the file will be treated as an undefined file when it is reloaded back into the KRONOS, and will be handled as a Standard MIDI File.

The diagram on the next page shows how the KRONOS handles files.

Since .PCG, .SNG, .KSC, .KFX and .KGE files can be opened to divide their contents, they are displayed as directory icons. Different colors are used to indicate different types of file.



Files available in Disk Mode

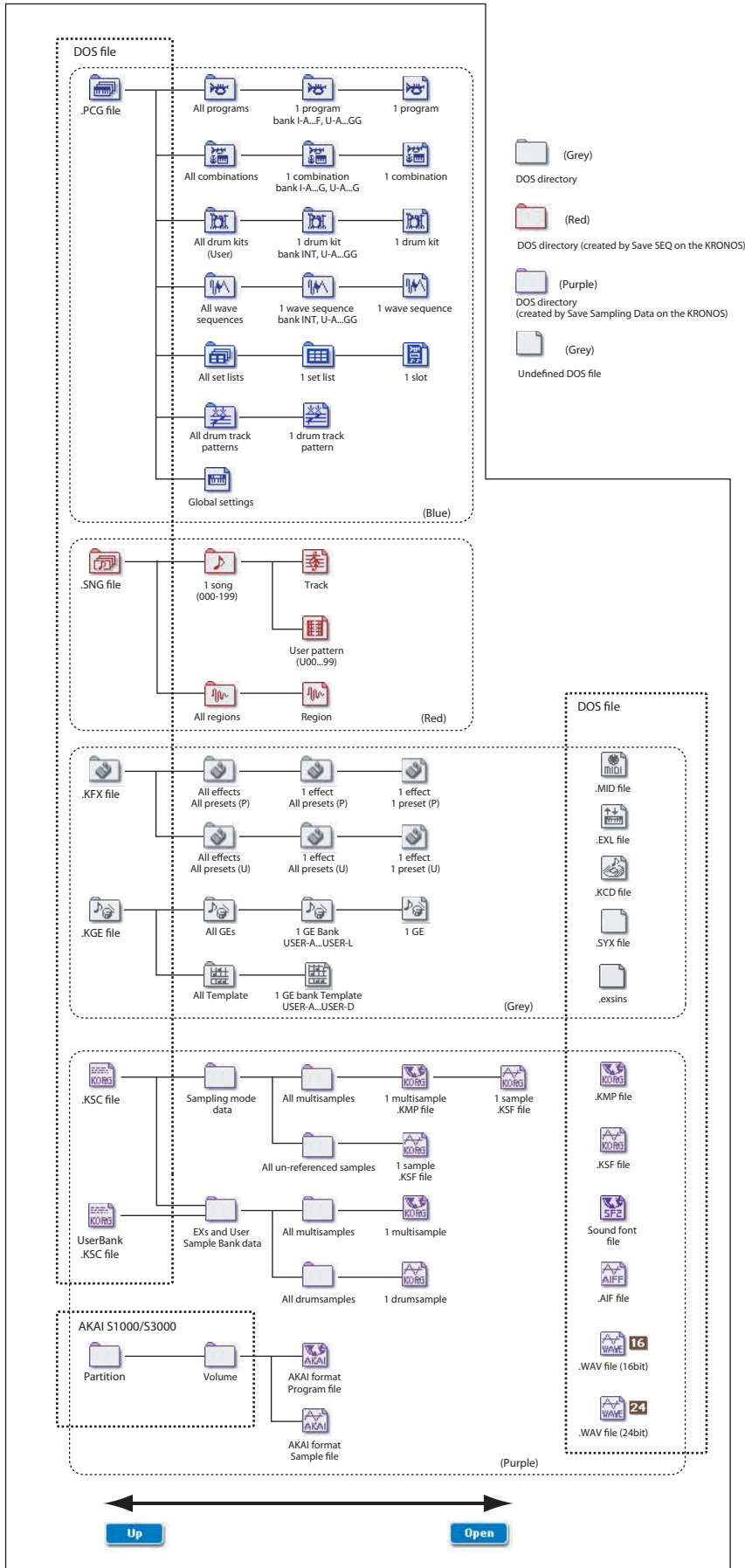



## Disk P0: File

### 0-1: Load

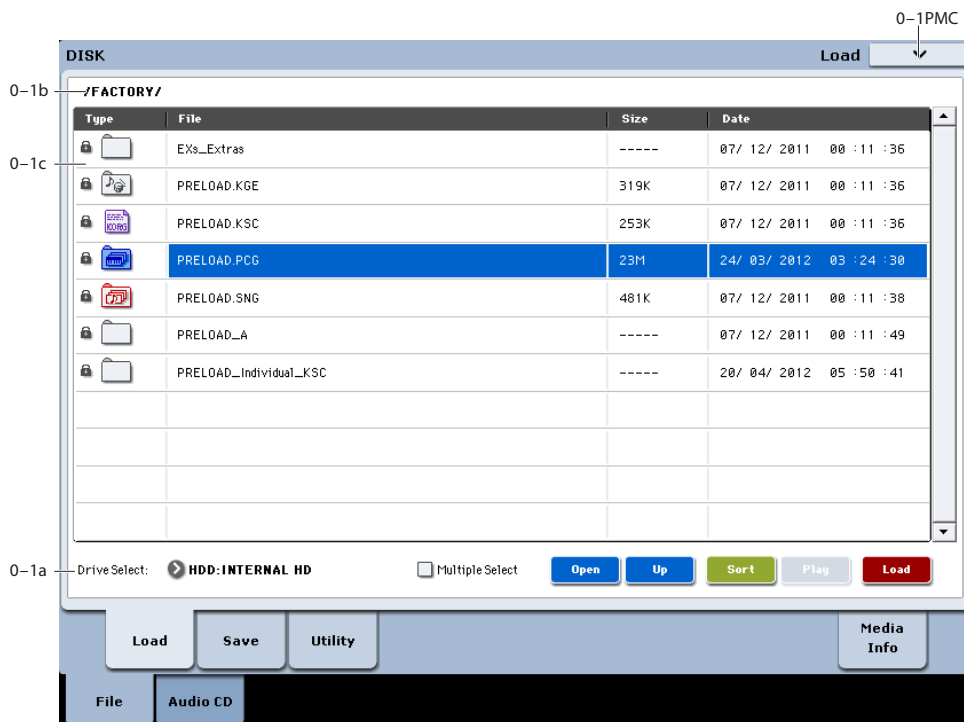

This page lets you load a selected file or directory into internal memory. Use the Open button and Up buttons to select the desired file or directory, and press the Load button to load it. You can also load data by using the **Load selected** page menu command.

### Auditioning sounds from disk

Whenever you've selected an individual Program, Combination, Drum Kit, or Wave Sequence from within a PCG file, you can play it from the keyboard immediately—no need to load it into memory!

To do this:

1. Select a PCG file on the disk.
2. Use the OPEN button to open the PCG file, so that you can see its contents.
3. Continue to use the OPEN button to navigate through the folders, until you've can see the name of the sound you'd like to audition.
4. Touch the name of the sound.
5. Play the sound from the keyboard.

When auditioning a Combination, the Timbres will use the Programs currently loaded into internal memory—which may be different from the Programs stored in the PCG file.

### Auditioning Drum Kits and Wave Sequences

When auditioning Drum Kits or Wave Sequences, you'll hear them as if they were being played through the parameter settings of the previously selected Program or Combination. This includes filter settings,

envelopes, etc. So, before you start auditioning sounds, it's best to first select a suitable sound in Program mode, and then return to Disk mode.

### Auditioning sounds which use non-ROM samples

When auditioning sounds from disks, the system can only use Samples and Multisamples which are already loaded. If a Program, Drum Kit, or Wave Sequence uses Sampling Mode, EXs, or User Sample Bank data which is not loaded, it will not sound correct when auditioned from disk.

### Auditioning WAVE files

You can also audition 44.1kHz and 48kHz WAVE files directly from disk. For more information, see "Play (WAVE Preview)" on page 818.

### 0-1a: Drive Select, Command buttons

**Drive Select** [HDD:INTERNAL HD, CDD, HDD, RDD: name]

Selects the device (hard disk, CD, etc.) that you will use for loading/saving.

The volume label assigned to the media will be displayed.

### Drive types

**HDD: INTERNAL HD:** Internal disk

**CDD:** USB CD-ROM or CD-R/RW drive

**HDD:** USB hard disk drive

**RDD:** Removable media such as flash media readers or MO (Magneto-Optical) drives

Volume label

No Label: Media that has no volume label

Unformatted: Media that has not been formatted

No Disc: Media is not inserted in the CD-ROM or CD-R/RW drive

No Media: Media is not inserted in the removable media drive (other than a CD-ROM or CD-R/RW drive)

The volume label display of a CD-R/RW drive will depend on the inserted media and the page.

Blank Disc: Blank media. (If you want to use this disc as a packet-writing-compatible disc, you must format it. If you want to use this disc to create an audio CD, you do not need to format it.)

Media volume label: Media that contains data

Audio CD: Audio CD

Unfinalized: An audio CD that has not been finalized

Audio CD or media volume label: Media that contains both data and audio. In this case, "Audio CD" will be displayed in both the Make Audio CD page and the Play Audio CD page, and the volume label of the media will be displayed in all other pages.

Multiple Select  Multiple Select [Off, On]

If this is checked, you will be able to select more than one file or directory. The check mark will turn on or off each time you press it, enabling or disabling multiple selection. Use this when you want to load or copy multiple files in a single operation.

Open

When you press the Open button, the directory will open, and the current directory will move one level downward.

This can be used when a directory has been selected in the directory window.

Up

When you press the Up button, the directory will move one level upward.

Sort  [Off, On]

This function sorts the files in the current directory.

Press the button to open the dialog box, and use the radio buttons to select the sorting method. Then press the OK button to execute.

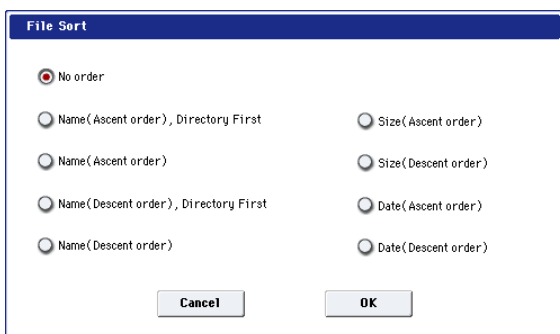

Choose one of the following sorting orders.

No order: Unsorted

Name (Ascending order), Directories First: Sort in alphabetical order, first directories and then files

Name (Ascending order): Sort alphabetically

Name (Descending order), Directories First: Sort in reverse alphabetical order, first directories and then files

Name (Descending order): Sort in reverse alphabetical

Size (Ascending order): Sort in ascending order of size

Size (Descending order): Sort in descending order of size

Date (Ascending order): Sort in ascending order of date

Date (Descending order): Sort in descending order of date

Play (WAVE Preview)

In the Load, Save, and Utility pages and dialog boxes, you can audition WAVE files directly from the disk.

When you select a WAVE file, the PLAY button will become active; simply press it to hear the file. You can also use the front-panel SAMPLING START/STOP switch.

Note: this is available only for 44.1kHz and 48kHz files.

Load

This loads the selected file or directory into internal memory.

When you press the Load button, a dialog box will appear. The specific contents of the dialog box will depend on the file you are loading. This is the same as the Load selected page menu command.

For more information, see "Load selected" on page 828.

Install

EXs installer files have the suffix .exsins. When one of these files is selected, the Load button will change to read Install. Pressing this button is the same as using the Install EXs menu command on the Disk Utility page.

Note that only one EXs can be installed at a time. If Multiple Select is On, Install will be disabled.

For more information, see "Install EXs" on page 855.

0-1b: Current Directory

Current Directory

The directory currently selected for processing is referred to as the "current directory."

The LCD screen will show the full path name of the directory. A slash "/" character is used as the delimiter between directory levels. To change the current directory, use the Open button and Up button (0-1a).

0-1c: Directory Window

This shows file information for the current directory. You can select a file or directory in this window.

**Type**

This icon indicates the type of file.

For details on how the icons correspond to the different file types, refer to the diagram “Files available in Disk Mode” on page 816.

**Lock**  **[Off, On]**

Files and directories with this symbol are locked, and cannot be overwritten, copied, or deleted. Use the “Lock/Unlock” page menu command to lock or unlock a file or directory.

**File**

When the menu command **Translation** is off (not checked), Multisample (.KMP) and Sample (.KSF) files will be shown with their low-level DOS file names—for example, “TROMB073.KMP.”

When **Translation** is on (checked), you’ll see the full 16-character Multisample and Sample names, as shown elsewhere in the system—for example, “Trombone Section.”

**Size**

This is the size of the file, in bytes.

**Date**

This is the date and time at which the file was saved. From the left, this is the year, month, day, hour, minute, and second.

To set the current date and time for the KRONOS system, use the Utility page menu command **Set Date/Time**. For more information, see “Set Date/Time” on page 853.

**▼ 0-1: Page Menu Commands**

The number before each command shows its ENTER + number-key shortcut. For more information on these shortcuts, see “ENTER + 0-9: shortcuts for menu commands” on page 147.

- **0: Hide unknown files.** For more information, see “Hide unknown files” on page 828.
- **1: Translation.** For more information, see “Translation” on page 828.
- **2: Show L/R as Stereo Pair.** For more information, see “Show L/R as Stereo Pair” on page 828.
- **3: Lock/Unlock selected.** For more information, see “Lock/Unlock selected” on page 828.
- **4: Load selected.** For more information, see “Load selected” on page 828.
- **5: Load PCG (RAM) and Samples.** For more information, see “Load PCG (RAM) and Samples” on page 844.

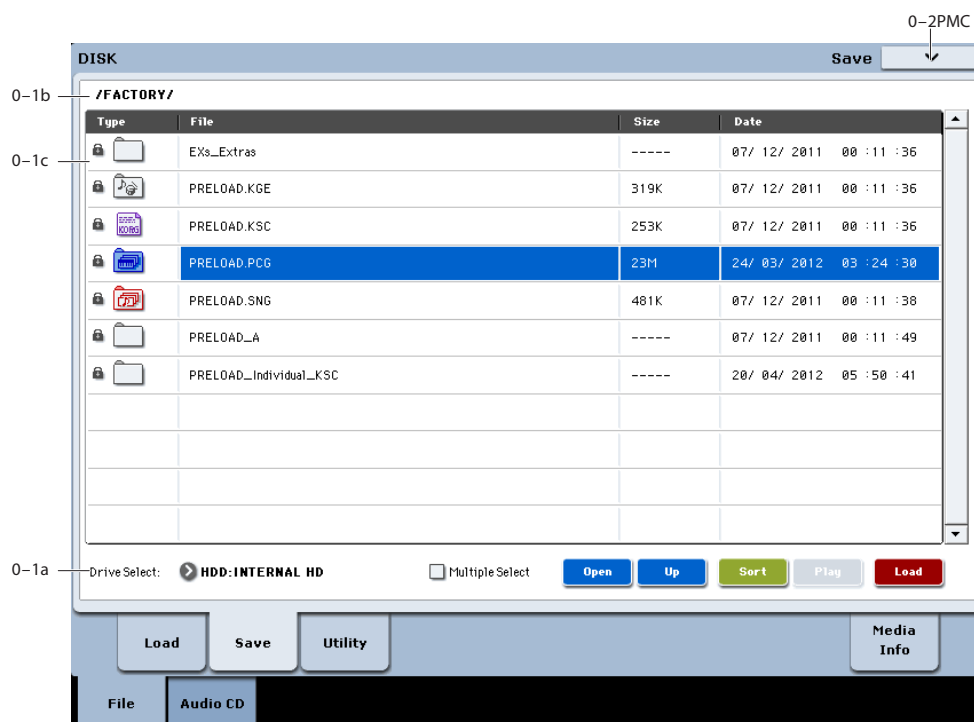
**0-2: Save**

Here you can save data from internal memory to internal or external disks, CD-R/RW, flash media, etc.

Use the Open button and Up button to move to the desired directory (i.e., change the current directory), and then select the desired page menu command.

When you execute a Save operation, the data will be saved in the current directory.

- ⚠ Do not turn off the power for at least 10 seconds after using any of the **Save** commands. This allows the system time to complete the process, which may continue in the background even after the disk operation appears to be complete.

### File date and time

The KRONOS contains an internal calendar and clock. When you save a file, the date and time will be assigned automatically.

To set the current date and time for the KRONOS system, use the Utility page menu command **Set Date/Time**. For more information, see “Set Date/Time” on page 853.

---

## ▼ 0–2: Page Menu Commands

The number before each command shows its ENTER + number-key shortcut. For more information on these shortcuts, see “ENTER + 0-9: shortcuts for menu commands” on page 147.

- 0: **Hide unknown files**. For more information, see “Hide unknown files” on page 828.
- 1: **Translation**. For more information, see “Translation” on page 828.
- 2: **Show L/R as Stereo Pair**. For more information, see “Show L/R as Stereo Pair” on page 828.
- 3: **Lock/Unlock selected**. For more information, see “Lock/Unlock selected” on page 828.
- 4: **Save All**. For more information, see “Save All (PCG, SNG and KSC)” on page 846.
- 5: **Save PCG & SEQ**. For more information, see “Save PCG & SEQ” on page 847.
- 6: **Save PCG**. For more information, see “Save PCG” on page 847.
- 7: **Save SEQ**. For more information, see “Save SEQ” on page 847.
- 8: **Save Sampling Data**. For more information, see “Save Sampling Data” on page 848.
- 9: **Save User GE**. For more information, see “Save User GE” on page 849.
- 10: **Save to Standard MIDI File**. For more information, see “Save to Standard MIDI File” on page 849.
- 11: **Save Exclusive**. For more information, see “Save Exclusive” on page 850.
- 12: **Save Effect Preset**. For more information, see “Save Effect Preset” on page 850.
- 13: **Export Sample as AIF/WAV**. For more information, see “Export Samples as AIF/WAV” on page 850.
- 14: **Save Audio CD Track List**. For more information, see “Save Audio CD Track List” on page 851.

## 0-3: Utility

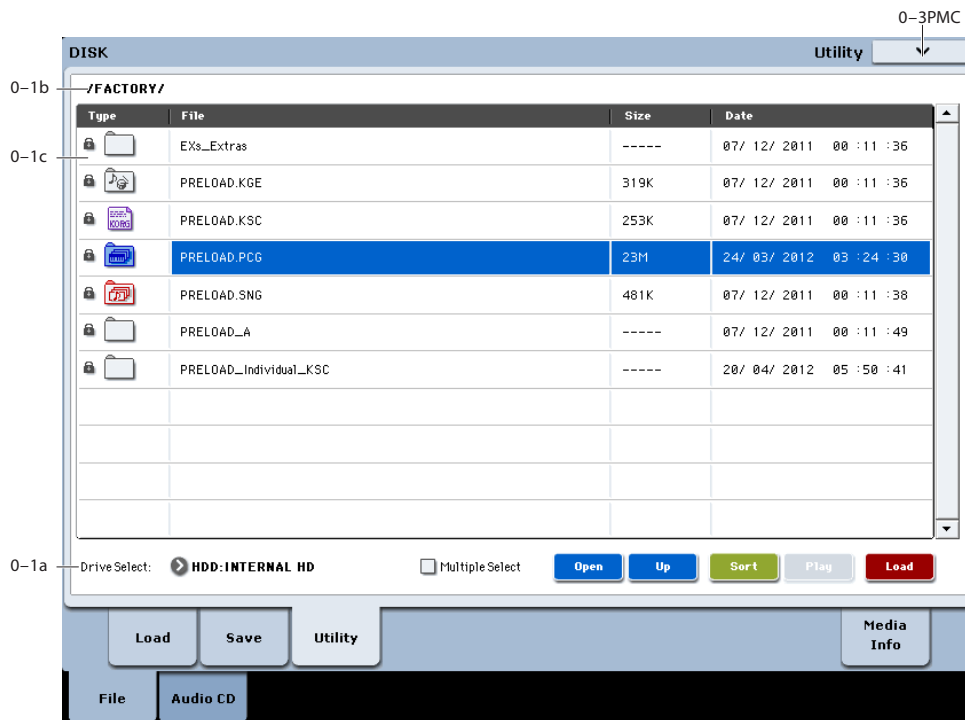

Here you can rename, copy, or delete the selected disk or file, create a new directory, format, and set the date and time.

After selecting a disk or file, select the desired page menu command.

- Do not turn off the power for at least 10 seconds after using any of the **Utility** commands. This allows the system time to complete the process, which may continue in the background even after the disk operation appears to be complete.

### ▼ 0-3: Page Menu Commands

The number before each command shows its ENTER + number-key shortcut. For more information on these shortcuts, see “ENTER + 0-9: shortcuts for menu commands” on page 147.

- 0: **Hide unknown files.** For more information, see “Hide unknown files” on page 828.
- 1: **Translation.** For more information, see “Translation” on page 828.
- 2: **Show L/R as Stereo Pair.** For more information, see “Show L/R as Stereo Pair” on page 828.
- 3: **Lock/Unlock selected.** For more information, see “Lock/Unlock selected” on page 828.
- 4: **Rename.** For more information, see “Rename” on page 851.
- 5: **Copy.** For more information, see “Copy” on page 851.
- 6: **Delete.** For more information, see “Delete” on page 852.
- 7: **Delete Unused WAV Files.** For more information, see “Delete Unused WAV Files” on page 852.
- 8: **Create Directory.** For more information, see “Create Directory” on page 852.
- 9: **Set Date/Time.** For more information, see “Set Date/Time” on page 853.
- 10: **Format.** For more information, see “Format” on page 853.
- 11: **Convert to ISO9660 Format.** For more information, see “Convert to ISO9660 Format” on page 853.
- 12: **Rate Convert.** For more information, see “Rate Convert” on page 854.
- 13: **Check Medium.** For more information, see “Check Medium” on page 854.
- 14: **Install EXs.** For more information, see “Install EXs” on page 855.

## 0-9: Media Information

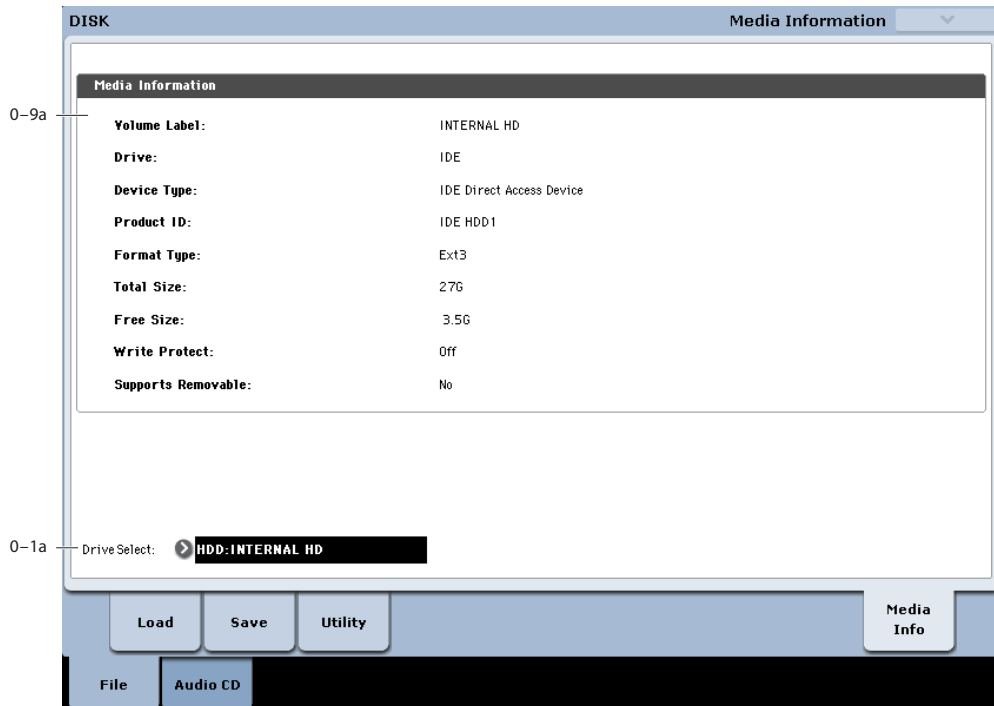

This screen shows information about the media. Use "Drive Select" to select the media.

### 0-9a: Media Information

**Volume Label:** The volume label of the media.

**Drive:** This is the specified drive.

**Device Type:** The type of media.

**Product ID:** The vendor ID, product, and product version, etc.

**Format Type:** The type of format. If not formatted, this will indicate "Unformatted."

**Total Size:** The capacity of the media (in bytes).

**Free Size:** The free capacity of the media (in bytes).

**Write Protect:** The write protect status of the media. This will indicate "On" if protected, or "Off" if not protected.

**Supports Removable:** This will indicate "Yes" if the media of the selected device can be removed (e.g., Compact Flash, CD-R/RW disc, MO disc, removable hard disk). If the media is fixed, this will be "No."

#### Drive Select

Selects the drive.

## Disk P1: Audio CD

### 1-1: Make Audio CD

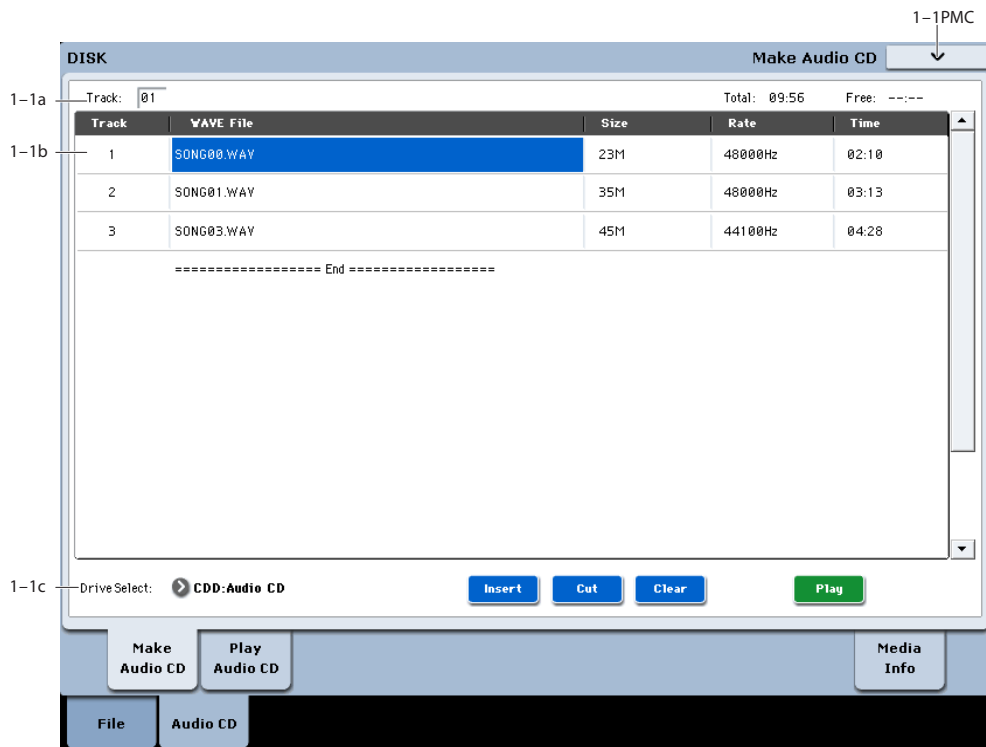

Here you can use a USB CD-R/RW drive to create an audio CD.

To create an audio CD, you can use WAVE files created by bouncing to disk in the KRONOS's sequencer. Use the Insert button and Cut button to arrange the files in the audio CD track list, and use the "Write to CD" page menu command to write them as an audio CD.

Audio CDs can be created from either 44.1 kHz or 48 kHz WAVE files. 48kHz files will be automatically converted to 44.1kHz during the CD writing process.

*Note:* When the name of a WAVE file is highlighted, you can play that file by pressing the Play button or the SAMPLING START/STOP switch. This is a convenient way to audition the sound.

#### What is Finalize?

In order for an audio CD to be playable on a conventional CD player, or to be played on the KRONOS (Disk: Audio CD page, Sampling P5: Audio CD page), the Finalize operation must be executed after all the desired audio CD tracks have been written to the CD-R/RW disc.

On the KRONOS, the **Write to CD** menu command allows you to simply write the audio CD tracks without finalizing the disc, and this means that other audio CD tracks can be added to that CD-R/RW disc at a later time.

No more audio CD tracks can be added to a disc once that disc has been finalized, so be sure that all desired audio CD tracks have been written before you finalize.

#### 1-1a: Track, Total, Free

##### Track (Track Select) [01...99, --]

Specifies the track number that will be displayed at the top of the audio CD track list.

If unfinalized media is inserted, this field will indicate the number that follows the last track number on that media. For example if data up to "Track (Track Select)" 05 has already been written, this will indicate 06 and following (up to 99).

If "WAVE file" "====End====" is at the top, this will indicate --.

Up to 99 tracks can be registered using the Insert button.

##### Total [00:00...]

Displays the total time of all WAVE files in the audio CD track list.

⚠ If the "Total" time is greater than "Free," writing to CD-R/RW media will not be possible.

##### Free [00:00..., ---]

Displays the time that remains on the media inserted in the CD-R/RW drive selected by "Drive Select."

If a CD-R/RW drive is not connected, or if it contains no media, or if the inserted media has already been finalized, this will display ---.



### 1-1b: Audio CD Track List

#### Track [(01...99)]

Displays the track numbers of the WAVE files arranged in the audio CD track list. (1-1a "Track (Track Select)")

#### WAVE File [List of files]

Displays the names of the WAVE files.

To add a WAVE file, place the cursor at the WAVE file of the audio CD track that follows the audio CD track you want to add, and press the Insert button. To delete an audio CD track, place the cursor at the audio CD track that you want to delete, and press the Cut button.

*Note:* When you select a WAVE file (highlighted) and press the Play button, or SAMPLING START/STOP switch, the WAVE file will play back.

#### Size, Rate, Time

This area displays information on the WAVE files in the audio CD track list.

**Size:** Data size (bytes)

**Rate:** Sampling frequency (Hz)

**Time:** Time (minutes: seconds)

 This information will not be displayed if you used "Load .KCD" etc. to load an audio CD track list, and the WAVE file is not found in the specified directory. In this case, use the Cut button to delete that audio CD track, or check whether the media is connected correctly.

### 1-1c: Drive Select, Command buttons

#### Drive Select [CDD: Name]

Selects the CD-R/RW drive that contains the media that you will use to create an audio CD. (0-1a)

 Only CD-ROM/R/RW drives can be selected.

#### Command buttons

##### Insert

Adds an audio CD track to the audio CD track list.

Highlight the "WAVE File" edit cell following the audio CD track you want to add, and press the Insert button to open the dialog box.

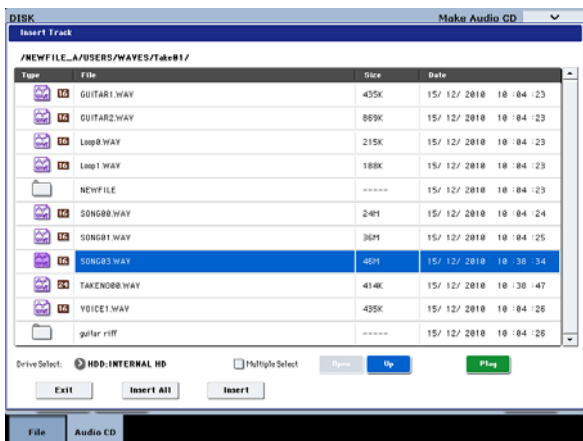

Use "Drive Select" to select the drive containing the file you want to add, use the Open button and Up button to navigate to the appropriate directory, and select the Wave file.

**Insert:** Adds the selected (highlighted) WAVE file.

*Note:* If **Multiple Select** is enabled, you can select multiple WAVE files and insert them in a single operation.

**Insert All:** Adds all WAVE files in the selected directory whose sampling frequency is 44.1 kHz or 48 kHz. The files will be added in the order in which they are displayed.

When you execute Insert or Insert All, the WAVE file(s) will be added, and any subsequent audio CD tracks will be moved toward the end of the list.

If you press the Exit button, the dialog box will close, and no further WAVE files will be added.

You can continue adding as many WAVE files as desired until you press the Exit button.

##### Cut

Deletes the audio CD track.

When you place the cursor at "WAVE File" of the audio CD track that you want to delete, and press the Cut button, that audio CD track will be deleted. Any subsequent audio CD tracks will be moved forward.

##### Clear

This clears the audio CD track list.

*Note:* Use "Save Audio CD Track List" to save important audio CD track lists to the internal hard disk or other media.

##### Play

In the Load, Save, and Utility pages and dialog boxes, you can audition WAVE files directly from the disk.

When you select a WAVE file, the PLAY button will become active; simply press it to hear the file. You can also use the front-panel SAMPLING START/STOP switch.

*Note:* this is available only for 44.1kHz and 48kHz files.

### ▼ 1-1: Page Menu Commands

The number before each command shows its ENTER + number-key shortcut. For more information on these shortcuts, see "ENTER + 0-9: shortcuts for menu commands" on page 147.

- 0: **Swap Track.** For more information, see "Swap Track" on page 854.
- 1: **Write to CD.** For more information, see "Write to CD" on page 854.
- 2: **Finalize Audio CD.** For more information, see "Finalize Audio CD" on page 855.
- 3: **Erase CD-RW.** For more information, see "Erase CD-RW" on page 855.

## 1-2: Play Audio CD

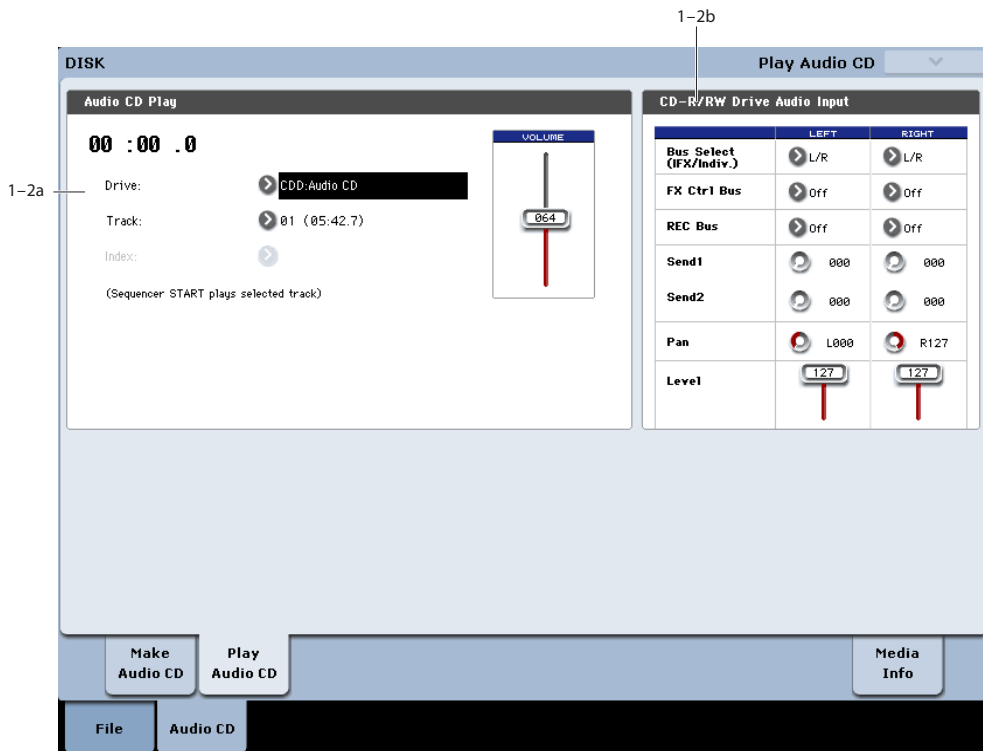

This page lets you play audio CDs from an external USB CD-R/RW drive. Among other things, this lets you verify CDs created using the Make Audio CD page.

 Audio CDs must be finalized before they can be played.

You can use the SEQUENCER switches to play or stop the CD. Audio is played using the digital audio signal from the CD-R/RW drive.

### Playing a CD

To play an audio CD:

1. Use Drive Select to select the CD-R/RW drive.
2. Set the desired level using the Volume slider. The default is 64.

Note that some USB CD drives may not support this control. In this case, use the individual left and right Level controls on the right side of the screen, instead.

3. Select the desired Track, using the popup menu.
4. Control the CD using the SEQUENCER switches, as shown below.

SEQUENCER	
START/STOP switch	Play/Stop
FF>> switch	Fast-forward
<<REW switch	Rewind
PAUSE switch	Pause
LOCATE switch	Return to the beginning of the track

### 1-2a: Audio CD Play

#### Location [00:00.0...]

Displays the current location of the audio CD track that is playing. When stopped, this specifies the location at which playback will begin.

After a **Track** or **Index** has been selected, this will be reset to 00:00.0.

#### Drive Select [CDD: Name]

Specifies the drive to play the audio CD. Only CD-ROM/R/RW drives can be selected.

#### Track [01...]

Selects the audio CD track to play.

#### Index [01...]

Audio tracks on CDs can have “indexes,” which mark points within the track. Some sample CDs may support indexes, for instance.

If the selected **Track** has indexes, this lets you select them.

Note that many CDs will not have indexes. Also, some CD-R/RW drives may not support indexes.

#### Volume [000...127]

This controls the CD-R/RW drive’s built-in volume.

Note that some USB CD-R/RW drives may not support direct control of volume. In this case, use the Level controls under “1-2b: CD-R/RW Drive Audio Input,” below.

## 1–2b: CD-R/RW Drive Audio Input

This specifies the output destination for the signal from an audio CD played back on a USB CD-R/RW drive. Make settings for the L and R channels.

*Note:* The CD-R/RW Drive Audio Input settings are linked with the Sampling mode “5–1b: CD-R/RW Drive Audio Input” settings.

### LEFT

### RIGHT

#### Bus Select (IFX/Indiv.)

[L/R, IFX1...12, 1...4, 1/2...3/4, Off]

**L/R:** The audio signal from the CD-R/RW drive will be sent to the L/R bus. Normally you will use the L/R setting. The signal can be monitored from the L/R outputs and from headphones.

**IFX1...12:** The audio signal from the CD-R/RW drive will be sent to the IFX1–12 bus. Choose this setting if you want to apply an insert effect.

**1...4:** The audio signal from the CD-R/RW drive will be sent in mono to INDIVIDUAL 1...4.

**1/2, 3/4:** The audio signal from the CD-R/RW drive will be sent via the **Pan** settings to INDIVIDUAL 1 and 2 or 3 and 4, in stereo.

**Off:** The audio signal from the CD-R/RW drive will not be input.

#### FX Ctrl Bus (FX Control Bus) [Off, 1, 2]

This sends the audio signal from the CD-R/RW drive to the FX Control buses (two stereo channels; FX Ctrl1, 2).

#### REC Bus [Off, 1, 2, 3, 4, 1/2, 3/4]

This sends the audio signal from the CD-R/RW drive to the REC buses (four mono channels 1, 2, 3, 4).

**Off:** The audio signal will not be sent to the REC bus. Normally you will use the Off setting.

**1, 2, 3, 4:** The audio signal from the CD-R/RW drive will be sent to the corresponding REC bus. The **Pan** setting will be ignored, and the signal will be sent in monaural.

**1/2, 3/4:** The audio signal from the CD-R/RW drive will be sent to the corresponding REC buses. The signal will be sent via the **Pan** setting to buses 1 and 2 or 3 and 4 in stereo.

#### Send1 (to MFX1) [000...127]

#### Send2 (to MFX2) [000...127]

These specify the level at which the audio signal from the CD-R/RW drive is sent to the master effects.

**Send1 (to MFX1):** Send the signal to master effect 1.

**Send2 (to MFX2):** Send the signal to master effect 2.

These settings are ignored if **Bus Select** is other than L/R or off.

If **Bus Select (IFX/Indiv.)** is set to IFX1–12, the send levels to the master effects are set by the post-IFX1–12 **Send1** and “Send2.”

#### Pan [L000...C064...R127]

This specifies the panning of the audio signal from the CD-R/RW drive. Normally you will set Left and Right to L000 and R127 respectively.

#### Level [000...127]

This specifies the level of the audio signal sent from the CD-R/RW drive. Normally you will set this to 127.

To summarize, the normal settings are as follows.

**LEFT:** **Bus Select (IFX/Indiv.)** L/R, **REC Bus** Off, **FX Ctrl Bus** Off, **Send1** 000, **Send2** 000, **Level** 127, **Pan** L000

**RIGHT:** **Bus Select (IFX/Indiv.)** L/R, **REC Bus** Off, **FX Ctrl Bus** Off, **Send1** 000, **Send2** 000, **Level** 127, **Pan** R127

## 1-9: Media Information

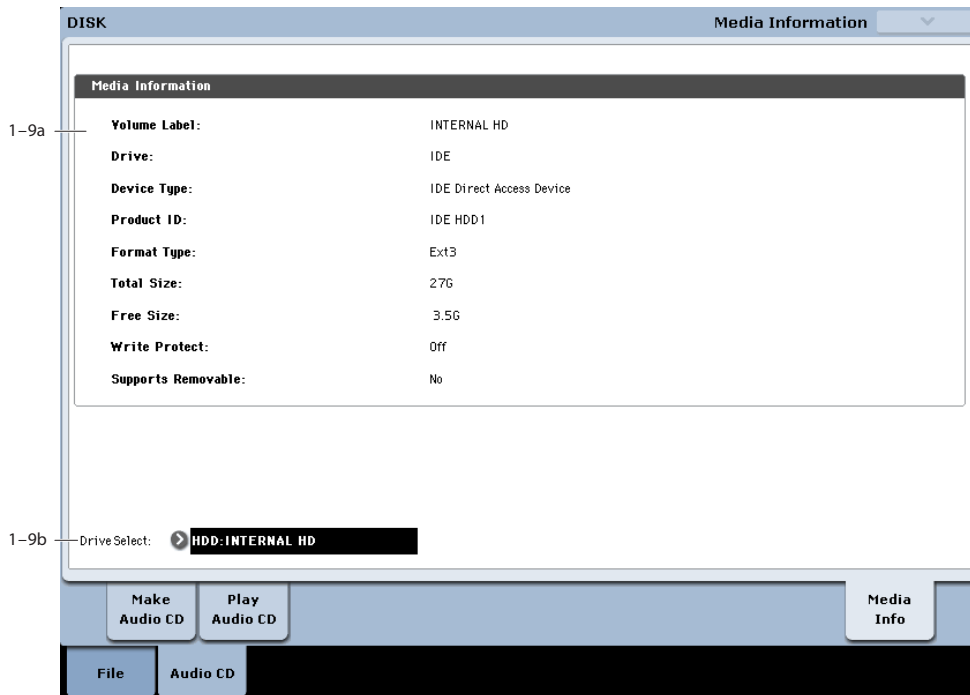

This screen shows information about the media in the CD-R/RW drive. Use "Drive Select" (1-9b) to select the drive/media.

For more information, please see "0-9: Media Information" on page 822.

## Disk: Page Menu Commands

---

### Hide unknown files

When this option is turned on, files not recognized by the KRONOS will not be shown in the directory window.

To turn **Hide unknown files** on and off, simply select the command in the menu. When on, a check mark will appear at the left of the name.

*Note:* this option applies only if there are DOS files in the current directory.

---

### Translation

When **Translation** is off (not checked), Multisample (.KMP) and Sample (.KSF) files will be shown with their low-level DOS file names—for example, "TROMB073.KMP."

When **Translation** is on (checked), you'll see the full 16-character Multisample and Sample names, as shown elsewhere in the system—for example, "Trombone Section."

---

### Show L/R as Stereo Pair

This command is only available when browsing into a .KSC file.

When this is enabled (shown as checked in the menu), stereo Multisamples, Drum Samples, and Samples in the KSC will appear as a single entry in the form of [name]-St. This can make long lists more compact and easier to read.

When this is disabled (shown as un-checked in the menu), the left and right channels of stereo Multisamples, Drum Samples, and Samples will appear individually in the form of [name]-L and [name]-R.

---

### Lock/Unlock selected

This locks/unlocks the file or directory that's selected in the directory window (0-1c). If you lock the file or directory, the lock icon ("Lock") will appear, and overwriting, copying, or deleting will not be possible.

1. In the directory window (0-1c), select the file or directory that you want to lock or unlock.
2. Select "Lock/Unlock"; the selected file or directory will alternately be locked or unlocked.

---

### Load selected

This loads the file or directory selected in the directory window (0-1c) into internal memory.

1. In the directory window (0-1c), select the file or directory that you want to load.
2. Select "Load selected."

A dialog box will appear. The dialog box that appears will contain different options, depending on the file you are loading. For more information,

please see the list of specific file types below. Specify the various items as necessary.

3. To load the data, press the OK button. If you decide to cancel, press the Cancel button.

For more information on loading specific file types, please see:

#### Program data

- "Load .PCG" on page 829
- "Load Programs" on page 831
- "Load Program Bank" on page 831
- "Load a single Program" on page 831

#### Combination data

- "Load Combinations" on page 831
- "Load Combination Bank" on page 831
- "Load a single Combination" on page 832
- "Load Drum Kits" on page 832

#### Global data

- "Load Drum Kit Bank" on page 832
- "Load a single Drum Kit" on page 832
- "Load Wave Sequences" on page 833
- "Load Wave Sequence Bank" on page 833
- "Load a single Wave Sequence" on page 833
- "Load Global Setting" on page 833

#### Sequencer data

- "Load .SNG" on page 833
- "Load a single Song" on page 834
- "Load Tracks" on page 834
- "Load Pattern Data" on page 834
- "Load Regions" on page 835
- "Load a Region" on page 835

#### Effects data

- "Load .KFX" on page 835
- "Load All FX Presets (P01...15)" on page 835
- "Load All User FX Presets (U00...15)" on page 835
- "Load Presets for a single Effect (P01-15)" on page 835
- "Load Presets (U00...15)" on page 836
- "Load a single Preset (P)" on page 836

#### MIDI and SysEx files

- "Load Standard MIDI File" on page 836
- "Load and Transmit MIDI SysEx Data" on page 836
- "Load .KCD" on page 837
- "Load DX-format .SYX file" on page 837

#### Sample data

- "Loading sample data" on page 837
- "Load .KSC" on page 838

- “Load .KMP” on page 839
- “Load .KSF” on page 840
- “Loading AIFF and WAVE files” on page 840
- “Load .AIF” on page 840
- “Load .WAV” on page 840
- “Loading AKAI S1000/S3000 format Sample files, Program files, or Volumes” on page 840
- “Load AKAI Sample File” on page 841
- “Load AKAI Program File” on page 841
- “Load AKAI Volume” on page 842

**KARMA data**

- “Load .KGE” on page 843
- “Load GEs” on page 843
- “Load GE Bank” on page 843
- “Load a single GE” on page 844

**Other data**

- “Load Templates” on page 844
- “Load Template Bank” on page 844
- “Load PCG (RAM) and Samples” on page 844

**If a file to be loaded cannot be found, or when loading a file that was saved across media**

If a necessary file cannot be found in the current directory or in a lower directory when loading multisamples, sample data, .PCG, or .SNG files, a dialog box like the following (Where is a ...) will appear.

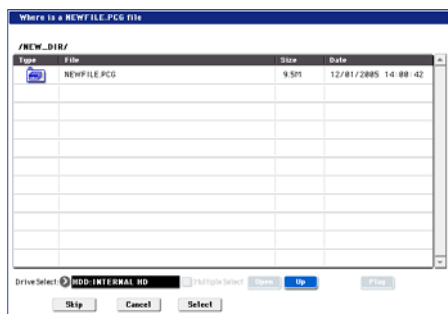

This will appear in the following cases.

- If when loading a .KSC file, a .KMP file used by it cannot be found.
- If when loading a .KMP file, a .KSF file cannot be found.
- If when loading an S1000/S3000 format Program file, a Sample file cannot be found.
- If loading a .KSF file that was larger than the media capacity and was therefore saved on multiple media, when the first media has been loaded and the second media needs to be specified.
- When loading a .PCG file that was split across two or more volumes of media, when the first volume has been loaded and the second media is now required.
- When loading a .PCG file and also simultaneously loading a .SNG file, if the identically-named .SNG file is not found in the current directory after loading the .PCG file.

If this dialog box appears, take the following action.

**1. Select the directory that contains the file indicated by “Where is a...”**

If the specified file is located on another media, exchange media. Then press the directory window in the LCD screen to make the KRONOS recognize the media, and select the appropriate directory.



It is not possible to open .PCG, .SNG, or .KFX files in the “Where is a ...” dialog box. The Open button cannot be used for .PCG, .SNG or .KFX files.

**2. Press the Select button to resume loading.**

Loading will be aborted if you press the Cancel button. If you want to abort the loading process, press the OK button. If you press the Skip button, the indicated file will be skipped, and the next file will be loaded.

Except for special situations such as when the media containing the indicated file has been damaged or cannot be found, you should use the Select button to continue the loading process.

**Load .PCG** 

Data in the .PCG file will be loaded.



**1. Use the “Load \*\*\*\*\* .SNG too”, “Load \*\*\*\*\* .KSC too” “Load \*\*\*\*\* .KGE too” and check boxes to select the .SNG file and .KSC file.**

If this file does not exist in the current directory, load it as described under “If a file to be loaded cannot be found, or when loading a file that was saved across media” on page 829.

**2. In “.PCG Contents,” specify the data to be loaded.**

**All:** Load all data from the .PCG file.

**Bank INT-A...G, USER-A...G and AA...GG:**

Load only the data of the specified bank. In this case, use “To” to specify the load destination bank. When you execute the load, the combinations, programs, drum kits, and wave sequence data of only the specified bank will be loaded to the load destination bank. Global settings will not be loaded.

The program banks used by the combinations and the drum kit and wave sequence numbers used by the programs will be adjusted automatically so that they correspond correctly.

Similarly if a .SNG file is loaded simultaneously, the bank of the programs used by tracks of the Song (or if there are track/pattern events, the bank of the program within the event) will be corrected automatically so that they are appropriate.

*Note:* Program banks INT-B...F are bank type HD-1, and the INT-A bank is bank type EXi. The bank

types for these banks are fixed; you cannot set the "To" field to a bank whose type differs from the data selected for loading.

Program banks USER-A...G and AA...GG can be freely specified as either HD-1 or EXi (using the Global menu command **Set Program User-Bank Type**). You can load .PCG files of a bank type that differs from the KRONOS's current bank type setting. This will automatically set the bank type appropriately.

- 🔊 If data of the specified bank is completely absent from the .PCG file, an error of "No readable data" will be displayed, and the load operation will be halted.
- 🔊 If the program data of the specified bank is not found in the .PCG file, the program banks of the combination or multi timbres/tracks will not be set.
- 🔊 If the drum kits and wave sequences of the specified bank are not in the .PCG file, the program's drum kit numbers and wave sequence numbers will not be automatically set.

**3. If "Load \*\*\*\*\*.SNG too" is checked, you can use "Select.SNG Allocation" to specify how song data within the .SNG file will be loaded.**

*.SNG Allocation*

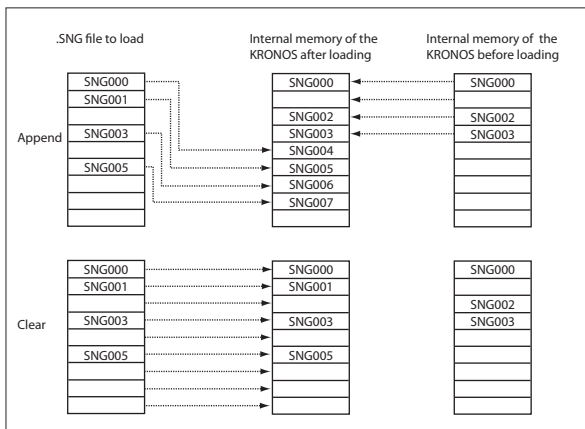

**Append:** The data will be loaded into song numbers starting after the last song in memory which contains data. The song data within the .SNG file that is being loaded will be packed into the available locations. (See diagram below)

Select this method when you wish to load song data from disk without erasing the song data that is already in memory.

The region data used by the song's audio tracks will be loaded following the last existing region number, with valid data packed into each consecutive location. (See diagram below) At this time, the region numbers of the song will be reassigned so that the songs in the .SNG file that use region data will correspond correctly to the region data.

**Clear:** Song data already in internal memory will be completely erased, and the song data will be loaded in the configuration that existed when it was saved. (See diagram below)

Select this when you want to reproduce the saved state immediately after power-on, etc.

**4. "KSC Allocation" is valid if "Load \*\*\*\*\*.KSC too" has been checked.**

This specifies how the Multisamples, Samples, and Drum Samples in the .KSC file will be loaded.

**Append** will leave all currently-loaded Sampling Mode, EXs, and User Sample Bank data intact. Sampling Mode Multisamples and Samples will be loaded into the next available vacant numbers following the existing data. (See diagram below.)

If the PCG's Programs, Wave Sequences, and Drum Kits use the KSC's Sampling Mode data, the system will automatically remap the Multisample and Sample references so that everything plays correctly.

**Clear Sampling Mode Data** will erase all Multisamples and Samples from Sampling Mode, and load the data in the same configuration with which it was saved. Existing EXs and User Sample Bank data is left intact.

**Clear All** is similar to **Clear Sampling Mode Data**, above, but also un-loads existing EXs and User Sample Bank data before loading the new .KSC file. This frees up the most memory for the new .KSC.

You can use the information at the bottom of the dialog box, including **Memory Required**, (**Memory Available**, and **Enough slots for Samples & MS**, to determine whether or not you need to free up room for the new .KSC.

*.KSC Allocation*

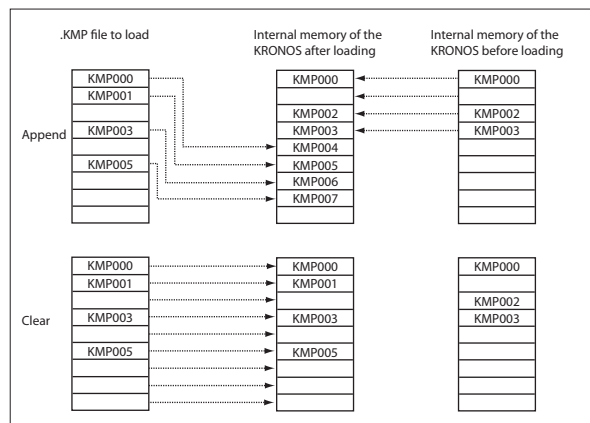

**5. Set the Load Method as desired.**

This sets the preferred way to load the EXs and User Sample Bank data in the KSC: load it into RAM, or use Virtual Memory. Note that if the data is extremely large, and would not fit into RAM regardless of which other samples were loaded, the data will use Virtual Memory regardless of this setting.

These settings apply only to EXs and User Sample Banks; Sampling Mode data is always loaded into RAM.

**RAM:** The samples will be loaded into RAM. This has the advantage of allowing reverse playback.

**Virtual Memory:** The samples will use Virtual Memory. This generally allows you to load more large samples at once. Note that the samples may still require a significant amount of RAM.

**KSC Settings:** KSCs can store separate load method settings for each Multisample or Drum Sample, based on the settings when the KSC was saved.



Setting **Load method** to **KSC Settings** uses these individual settings.

- To load the data, press the OK button. To cancel without loading, press the Cancel button.

### Load Programs

All program data from the .PCG file will be loaded.

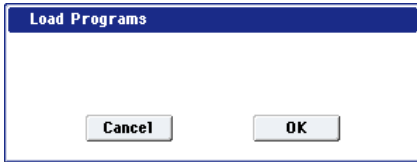

- To load the data, press the OK button. To cancel without loading, press the Cancel button.

### Load Program Bank

[INT-A...F, USER-A...G and AA...GG]

All program data of the selected bank will be loaded into the bank you specify.

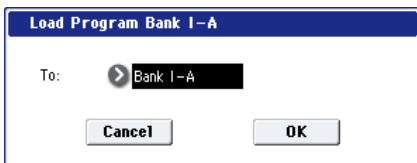

- In "To," select the loading destination bank.
- To load the data, press the OK button. To cancel without loading, press the Cancel button.

*Note:* INT-A is an EXi bank, and INT-B...F are HD-1 banks. The types of these banks are fixed; you cannot set the "To" field to a bank whose type differs from the data selected for loading.

Banks USER-A...G and AA...GG can be freely specified as either HD-1 or EXi (see "Set Program User-Bank Type" on page 806). You can load .PCG files of a bank type that differs from the KRONOS's current bank type setting, and the bank type will be changed automatically.

*Note:* If "Multiple Select" (0-1a) is checked and you've selected more than one bank, the data will be loaded starting with the bank specified in the "To" field. In this case, if you attempt to load a bank of a differing bank type into INT-A (fixed at EXi) or INT-B...F (fixed at HD-1), the INT banks will be skipped, and the data will be loaded starting from USER-A.

### Load a single Program

Data for the selected program will be loaded into the program number you specify.



- If you wish to load a program other than the one already selected, use "Program" (upper line) to select the program that you wish to load.

*Note:* Whenever you've selected an individual Program, Combination, Drum Kit, or Wave Sequence from within a PCG file, you can play it from the keyboard immediately—no need to load it into memory! For more information, see "Auditioning sounds from disk" on page 817.

- In "To Program," (lower line) select the bank and program into which the data will be loaded. When you press the popup button, the "Bank/Program Select" window (Program 0-1a) will appear.

*Note:* You cannot set the "To" field to a bank whose type differs from the selected program.

*Note:* If "Multiple Select" (0-1a) is checked and you've selected more than one program, the data will be loaded starting with the program you specified in the "To" field.

- To load the data, press the OK button. To cancel without loading, press the Cancel button.

### Load Combinations

All combinations in the .PCG file will be loaded.

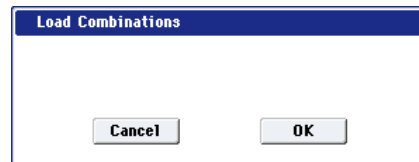

- To load the data, press the OK button. To cancel without loading, press the Cancel button.

### Load Combination Bank

[INT-A...G, USER-A...G]

All combinations in the selected bank will be loaded into the bank you specify.

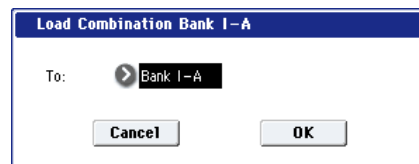

- In "To," specify the loading destination bank.
- To load the data, press the OK button. To cancel without loading, press the Cancel button.

*Note:* If "Multiple Select" (0-1a) is checked and you've selected more than one bank, the data will be loaded starting with the bank you specified in the "To" field.

### Load a single Combination

This loads the selected Combination into a specified Bank and number in internal memory.

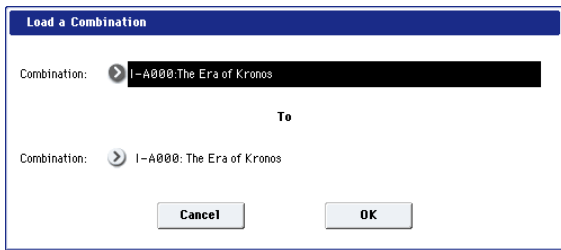

1. If you wish to load a combination other than the one already selected, use “Combination” (upper line) to select the combination that you wish to load.

*Note:* The selected combination can be played from the keyboard even before you load it. This is convenient when you want to audition the combination to be loaded. (See “Auditioning sounds from disk” on page 817)

2. In “To Combination” (lower line), select the bank and combination into which the data will be loaded.

When you press the popup button, the “Bank/Combination Select” window will appear.

3. To load the data, press the OK button. To cancel without loading, press the Cancel button.

*Note:* If “Multiple Select” (0–1a) is checked and you’ve selected more than one combination, the data will be loaded starting with the combination you specified in the “To” field.

### Load Drum Kits

All drum kits in the .PCG file will be loaded.

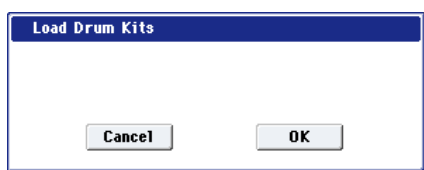

1. To load the data, press the OK button. To cancel without loading, press the Cancel button.

### Load Drum Kit Bank

[INT, USER–A...G and AA...GG]

This loads all drum kit data of the selected bank into the load-destination bank you specify.

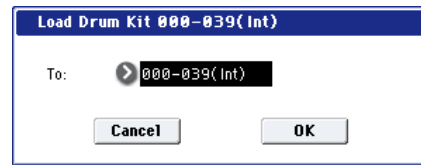

1. Use the “To” field to select the load-destination bank.
2. To load the data, press the OK button. To cancel without loading, press the Cancel button.

*Note:* If “Multiple Select” (0–1a) is checked and you’ve selected more than one bank, the data will be loaded starting with the bank you specified in the “To” field.

-  The INT bank can hold 40 Drum Kits, while each USER bank can hold only 16. If you load from a stored INT bank into one of the USER banks, only the first 16 Drum Kits will be loaded (INT–000 ...015). Conversely, if you load from a stored USER bank into the INT bank, the Drum Kits will be loaded into the first 16 slots (INT–000 ...015), and the remaining Drum Kits will be unaffected.

### Load a single Drum Kit

The selected drum kit will be loaded into the drum kit number you specify.

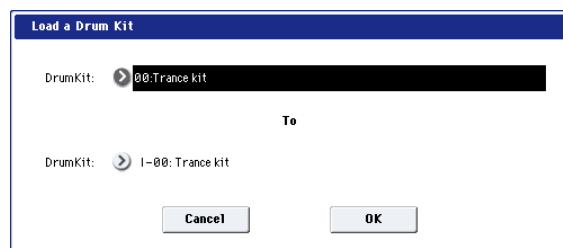

1. If you wish to load a drum kit other than the one already selected, use “Drum Kit” (upper line) to select the drum kit you wish to load.

*Note:* Whenever you’ve selected an individual Program, Combination, Drum Kit, or Wave Sequence from within a PCG file, you can play it from the keyboard immediately—no need to load it into memory! For more information, see “Auditioning sounds from disk” on page 817.

2. In “To Drum Kit” (lower line), select the loading destination drum kit.
3. To load the data, press the OK button. To cancel without loading, press the Cancel button.

*Note:* If “Multiple Select” (0–1a) is checked and you’ve selected more than one bank, the data will be loaded starting with the drum kit you specified in the “To” field.

### Load Wave Sequences

All wave sequence data of the .PCG file will be loaded.

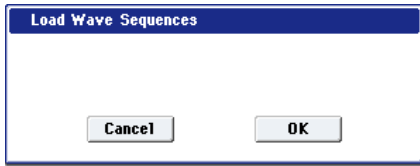

1. To load the data, press the OK button. To cancel without loading, press the Cancel button.

### Load Wave Sequence Bank

[INT, USER-A...G and AA...GG]

All wave sequence data of the selected bank will be loaded into the bank you select as the load-destination.

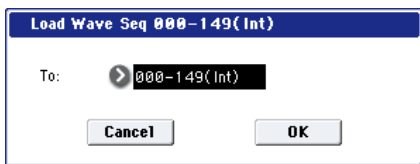

1. Use the "To" field to select the load-destination bank.
2. To load the data, press the OK button. To cancel without loading, press the Cancel button.

Note: If "Multiple Select" (0-1a) is checked and you've selected more than one bank, the data will be loaded starting with the bank you specified in the "To" field.

-  The INT bank can hold 150 Wave Sequences, while each USER bank can hold only 32. If you load from a stored INT bank into one of the USER banks, only the first 32 Wave Sequences will be loaded (INT-000 ...031). Conversely, if you load from a stored USER bank into the INT bank, the Wave Sequences will be loaded into the first 32 slots (INT-000 ...031), and the remaining Wave Sequences will be unaffected.

### Load a single Wave Sequence

The selected wave sequence data will be loaded into the wave sequence number you select as the load-destination.



1. If you want to load a wave sequence other than the selected wave sequence, use "Wave Sequence" (the upper line) to re-select the wave sequence to be loaded.

Note: Whenever you've selected an individual Program, Combination, Drum Kit, or Wave Sequence from within a PCG file, you can play it

from the keyboard immediately—no need to load it into memory! For more information, see "Auditioning sounds from disk" on page 817.

2. Use "To Wave Sequence" (the lower line) to select the load-destination wave sequence.
3. To load the data, press the OK button. To cancel without loading, press the Cancel button.

Note: If "Multiple Select" (0-1a) is checked and you've selected more than one wave sequence, the data will be loaded starting with the wave sequence you specified in the "To" field.

### Load Global Setting

Global setting data in the .PCG file will be loaded.

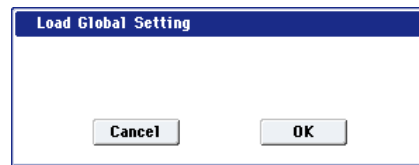

This includes most of the Global mode parameters, except for the following:

- Drum Kits
- Wave Sequences
- Memory Protect settings
- System Clock setting

1. To load the data, press the OK button. To cancel without loading, press the Cancel button.

### Load .SNG

All data in the .SNG file will be loaded.



1. Use "Select .SNG Allocation" to specify how the song data from the .SNG file will be loaded.

**Append:** The data will be loaded into song numbers starting after the last song in memory which contains data. At this time, the song data in the .SNG file being loaded will be packed forward. (See the diagram "SNG Allocation" on page 830)

Select this when you want to add song data from disk without erasing the song data that currently exists in internal memory.

The region data used by the song's audio tracks will also be loaded following the last region number existing in internal memory, with valid data packed into each consecutive location. At this time, the

region numbers of the song will be reassigned so that the songs in the .SNG file that use region data will correspond correctly to the region data.

**Clear:** Song data already in internal memory will be completely erased, and the song data will be loaded in the configuration that existed when it was saved. (See the diagram “.SNG Allocation” on page 830)

Select this when you want to reproduce the saved state immediately after power-on, etc.

2. If an identically-named .PCG, .KSC, or .KGE file exists in the current directory, you'll be able to select the “Load \*\*\*\*\*.PCG too,” “Load \*\*\*\*\*.KSC too,” and “Load \*\*\*\*\*.KGE too” check boxes.

If this file does not exist in the current directory, load it as described under “If a file to be loaded cannot be found, or when loading a file that was saved across media” on page 829.

- If you check “Load \*\*\*\*\*.PCG too,” use “.PCG Contents” to specify the bank within the .PCG file. For more information, see “In “.PCG Contents,” specify the data to be loaded.” on page 829.
  - If you check “Load \*\*\*\*\*.KSC too,” use “.KSC Allocation” to specify how the multisamples and samples within the .KSC file will be loaded. For more information, see “.KSC Allocation” is valid if “Load \*\*\*\*\*.KSC too” has been checked.” on page 830.
3. Press the OK button to load the data, or press the Cancel button to cancel without loading.

### Load a single Song



Data for the selected song will be loaded into the song number you specified as the load destination.



1. If you wish to load a song other than the selected song, use Song (upper line) to re-select the song to be loaded.
2. In “To Song” (lower line), select the loading destination song.
3. If you've enabled the “with Region Data” checkbox, the Song's region data will be loaded following the last region number existing in internal memory, with data packed into each consecutive location (Append load).

At this time, the region numbers of the song will be reassigned so that they correspond correctly to the region data.

4. To load the data, press the OK button. To cancel without loading, press the Cancel button.

### Load Tracks



The event data of all tracks in the selected song will be loaded into the song you specify as the loading destination. However, it is not possible to specify an uncreated song as the loading destination.

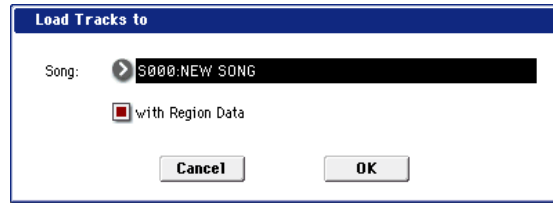

1. In Song, specify the loading destination song.
2. If you've enabled the “with Region Data” checkbox, the region data used by the song tracks being loaded will also be loaded following the last region number existing in internal memory, with data packed into each consecutive location (Append load).  
At this time, the region numbers of the tracks in the song will be reassigned so that they correspond correctly to the region data.
3. To load the data, press the OK button. To cancel without loading, press the Cancel button.

### Load Pattern Data



The selected user pattern will be loaded into a user pattern of the selected loading destination song. However, it is not possible to specify an uncreated song as the loading destination.

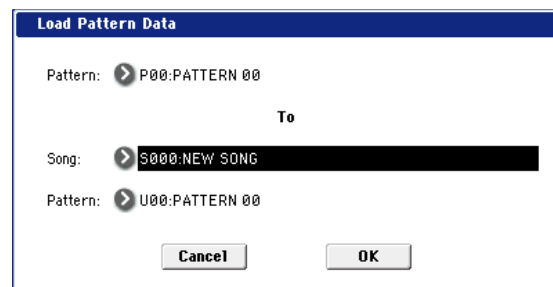

1. If you wish to load a user pattern other than the one already selected, use Pattern (upper line) to re-select the user pattern that you wish to load.
2. In “To Song” and Pattern (lower line), select the loading destination song and user pattern.
3. To load the data, press the OK button. To cancel without loading, press the Cancel button.

## Load Regions

All region data will be loaded from the .SNG file.

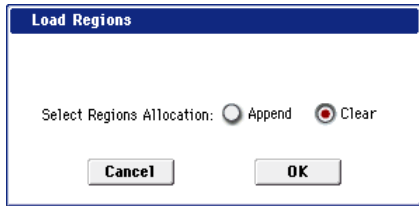

1. Use "Select Regions Allocation" to specify how the song data in the .SNG file will be loaded.

**Append:** The data will be packed into each consecutive location following the last region number existing in internal memory. Choose this method when you want to load additional region data from the disk without erasing the region data already in internal memory.

**Clear:** All region data in internal memory will be erased, and the region data will be loaded in the configuration that existed when it was saved. Choose this method when you want to replicate the configuration that you saved, such as immediately after turning the power on.

 If you load using Append, the region numbers used by the song may no longer correspond correctly. If so, you will need to re-select the region numbers used by the song. When loading song data, you will normally use Load .SNG or Load a Song and check the "with Region Data" setting. Even if you load using Append, the region numbers of the song will automatically be re-specified so that the song will correspond to the correct region data.

2. To load the data, press the OK button. To cancel without loading, press the Cancel button.

## Load a Region

This loads the selected region data into the region number you select as the load-destination.

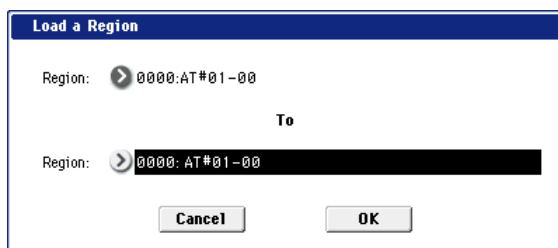

1. If you're loading region data other than the selected data, use "Region" (the upper line) to reselect the region data you want to load.
2. Use "To Region" (the lower line) to select the load-destination region.
3. To load the data, press the OK button. To cancel without loading, press the Cancel button.

## Load .KFX

All data from the .KFX file will be loaded. All preset data (P01–15) and user data (U00–15) for all effects will be loaded.



1. To load the data, press the OK button. To cancel without loading, press the Cancel button.

## Load All FX Presets (P01...15)

All preset data from the .KFX file will be loaded. All preset (preset) data (P01–15) for all effects will be loaded.

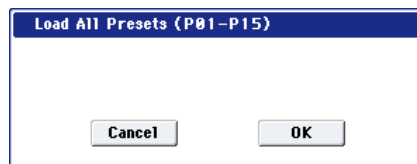

1. To load the data, press the OK button. To cancel without loading, press the Cancel button.

## Load All User FX Presets (U00...15)

All user data from the .KFX file will be loaded. All preset (user) data (U01–15) for all effects will be loaded.

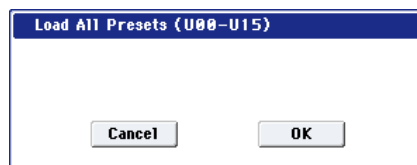

1. To load the data, press the OK button. To cancel without loading, press the Cancel button.

## Load Presets for a single Effect (P01–15)

Preset (preset) data (P01–15) for the selected effect will be loaded.

*Load Presets (P01-P15) in "Stereo Dyna Compressor"*

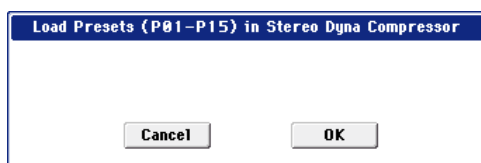

1. To load the data, press the OK button. To cancel without loading, press the Cancel button.



### Load Presets (U00...15)

Preset (user) data (U00–15) for the selected effect will be loaded.

*Load Presets (U00-U15) in "Stereo Dyna Compressor"*

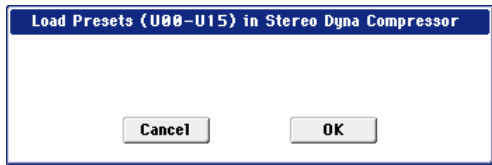

1. To load the data, press the OK button. To cancel without loading, press the Cancel button.

### Load a single Preset (P)

The selected effect preset data (P01–15) will be loaded into the load-destination effect preset number (P01–15, U00–U15) you specify.

*Load a Preset in "Stereo Dyna Compressor"*

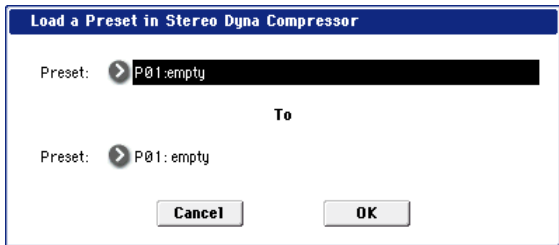

1. If you're loading an effect preset other than the selected one, use "Preset" (the upper line) to re-select the effect preset that will be loaded.
2. Use "To Preset" (the lower line) to select the load-destination effect preset.
3. To load the data, press the OK button. To cancel without loading, press the Cancel button.

*Note:* If "Multiple Select" (0–1a) is checked and you've selected more than one effect preset, the data will be loaded starting with the effect preset you specified in the "To" field.

### Load a Preset (U)

The selected effect preset data (U00–15) will be loaded into the load-destination effect preset number (P01–15, U00–U15) you specify.

For more information, see "Load a single Preset (P)" on page 836.

### Load Standard MIDI File



The selected Standard MIDI File will be loaded into the song number you select as the loading destination.

*"Load Standard MIDI File \*\*\*\*\*.MID to"*



1. In Song, select the loading destination song.
2. If you turn "Exclusive" Off (unchecked), any system exclusive messages or universal exclusive messages included in the SMF data will not be loaded.

If this is On (checked), system exclusive messages and universal exclusive messages included in the SMF data will be loaded as System Exclusive events.

-  The GS/XG sound maps and messages are not supported. Depending on the content of the data, it may not play back correctly, but the data itself will be maintained if **Exclusive** is checked.
- 3. To load the data, press the OK button. To cancel without loading, press the Cancel button.
-  If you select an undefined file and choose **Load selected**, the file will be assumed to be a Standard MIDI File, and the **Load Standard MIDI File** dialog box will appear. When you execute loading, the file will be loaded into the song that was specified as the loading destination. However if the file format is inappropriate, the operation will be invalid and an error message will be displayed.
-  The program bank and program numbers loaded into the song will follow the "Bank Map" (Global 0–1d) setting. If "Bank Map" is Korg, bank A will be selected for bank select 00.00 (MSB.LSB). If "Bank Map" is GM(2), bank G will be selected.

### Load and Transmit MIDI SysEx Data

All data from the .EXL file will be loaded and transmitted from the MIDI OUT connector.

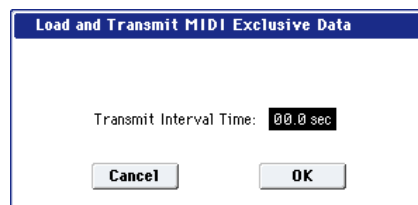

1. If the .EXL file contains two or more exclusive data items, use "Transmit Interval Time" to specify the time interval that will be inserted between each item of exclusive data.

If you are transmitting the data to another KRONOS, the required time interval will depend on the type of data. After transmitting all program data, you must allow an interval of approximately 2 seconds. For more information, see "System

Exclusive Data Dumps” on page 810. For other MIDI devices, refer to their owner’s manual.

2. To load the data, press the OK button. To cancel without loading, press the Cancel button.

 The maximum data size that can be transmitted is 1,048,576 bytes.

### Load .KCD



The selected .KCD file will be loaded.

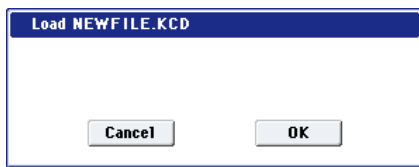

1. Press the OK button to load, or press the Cancel button to cancel without loading.

The loaded contents will be displayed in the Make Audio CD page (1-1). As the data is being loaded, the WAVE files in the list will be checked, and if a file does not exist, a message of “File/Path not found” will be displayed.

### Load DX-format .SYX file

The KRONOS can load sounds created for the vintage Yamaha DX7. These sounds will be converted into MOD-7 Programs. For more information, please see “Loading DX sounds” on page 339.

### Loading sample data

The explanations under Load .KSC, Load .KMP, and Load .KSF, below, explain how Korg format PCM data files are loaded into Sampling Mode.

### About sample RAM

The amount of RAM available for Sampling Mode will vary, depending on both the amount of physical RAM, and which (if any) EXs or User Sample Bank data is currently loaded. For more information, see “Sampling and RAM” on page 675.

### Maximum numbers of Samples and Multisamples that can be loaded into Sampling Mode

- Multisamples: up to 4,000
- Samples: up to 16,000
- Samples used by multisamples (“Indexes”): up to 16,000

### About Korg format PCM data files

#### KSC files



KSC stands for Korg Sample Collection. KSC files contain links to Sampling Mode, EXs, and/or User Sample Bank data, including Multisamples, Samples, and Drum Samples. Loading a KSC file loads all of the linked sample data, including .KMP and .KSF files as well as EXs and/or User Sample Bank data.

When saving, a .KSC file and a directory with the same name as the .KSC file will be created. The .KMP files and .KSF files listed in the .KSC file will be saved in this directory. EXs and User Sample Bank data are only linked, and not saved again.

For more information on User Sample Banks, see “User Sample Banks” on page 154 of the Operation Guide.

#### KMP files



Files with the extension .KMP (Korg Multisample Parameters) contain the parameters which make up a single multisample. These parameters also include the filename of the .KSF files that are used by that multisample, so when a .KMP file is loaded, the necessary .KSF files will also be loaded at the same time.

When saving, a .KMP file and a directory with the same name will be created, and the .KSF files used by the multisample will be saved in this directory.

#### KSF files



Files with the extension .KSF (Korg Sample File) contain the parameters and waveform data which make up a single sample.

A .KSF file can be used as one of the samples used by a multisample. A .KSF file can also be selected and used as a drum sample for a drum kit.

### Loading multiple files at once

You can use wild cards to specify multiple .KMP, .KSF, .AIF, .WAV, AKAI Program, AKAI Sample, and Sound Font 2.0 files, and load them simultaneously.

*Note:* For simply selecting two or more files at once, just check the **Multiple Select** check-box. You can then load (or copy) the files in a single operation.

In the Load dialog box, press the text edit button to access the text input dialog box.

By specifying “\*” or “?” as wild cards in the selected filename, multiple sample files that have the same filename extension (same file format) and exist in the selected directory can be loaded simultaneously.



**Example)** A folder contains the following files, and you select “SFX\_A\_00.WAV” and specify wild cards to load multiple files simultaneously

PIANO.WAV  
SFX\_A\_00.WAV  
SFX\_A\_01.WAV  
SFX\_B\_00.WAV  
SFX\_B\_01.WAV  
SFX\_C\_00.WAV



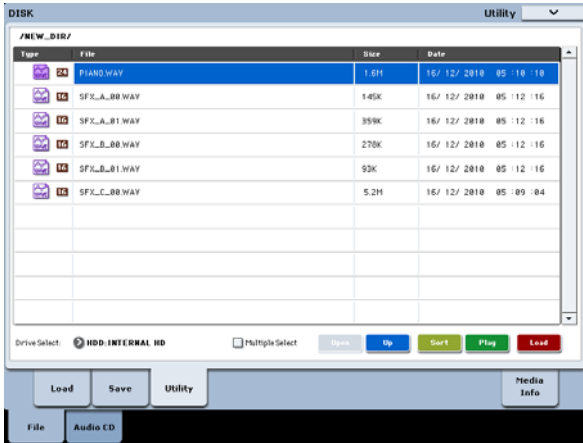

Select "SFX\_A\_00.WAV," and choose "Load selected" to open the dialog box.

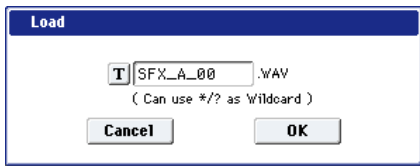

Press the text edit button (T) to access the text input dialog box, and specify the desired wildcards.

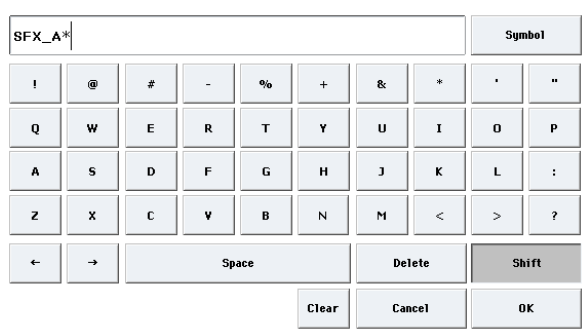

"\*" specifies the subsequent characters as a wild card.

"?" specifies only one character as a wild card.

1. If you specify SFX\_A\* and execute loading, the following files will be loaded.  
SFX\_A\_00.WAV  
SFX\_A\_01.WAV
2. If you specify SFX\_?\_00 and execute loading, the following files will be loaded.  
SFX\_A\_00.WAV  
SFX\_B\_00.WAV  
SFX\_C\_00.WAV
3. If you specify SFX\_\*\_00, the result will be the same as if you specify "SFX\_?", and the following files will be loaded.  
SFX\_A\_00.WAV  
SFX\_A\_01.WAV  
SFX\_B\_00.WAV  
SFX\_B\_01.WAV  
SFX\_C\_00.WAV
4. If you specify \* and execute loading, all of the WAVE files will be loaded as follows.

- PIANO.WAV
- SFX\_A\_00.WAV
- SFX\_A\_01.WAV
- SFX\_B\_00.WAV
- SFX\_B\_01.WAV
- SFX\_C\_00.WAV

**Load .KSC**

This loads all of the Sampling Mode, EXs, and/or User Sample Bank Multisamples, Samples, and Drum Samples linked within the KSC.

For more information on User Sample Banks, see "User Sample Banks" on page 154 of the Operation Guide.

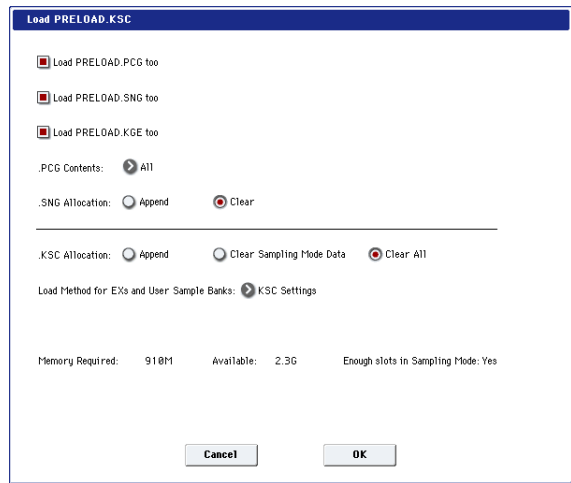

If the KSC includes Sampling Mode data, the Multisamples and Samples (.KMP and .KSF files) are saved in an automatically-created directory with the same name as the .KSC file.

**1. "KSC Allocation" allows you to specify how the multisamples and samples in the .KSC file will be loaded.**

**Append** will leave all currently-loaded Sampling Mode, EXs, and User Sample Bank data intact. Sampling Mode Multisamples and Samples will be loaded into the next available vacant numbers following the existing data. (See the diagram "KSC Allocation" on page 830.)

If "Load \*\*\*\*\*.PCG too" is enabled, and the PCG's Programs, Wave Sequences, and Drum Kits use the KSC's Sampling Mode data, the system will automatically remap the Multisample and Sample references so that everything plays correctly.

**Clear Sampling Mode Data** will erase all Multisamples and Samples from Sampling Mode, and load the data in the same configuration with which it was saved. Existing EXs and User Sample Bank data is left intact.

**Clear All** is similar to **Clear Sampling Mode Data**, above, but also un-loads existing EXs and User Sample Bank data before loading the new .KSC file. This frees up the most memory for the new .KSC.

You can use the information at the bottom of the dialog box, including **Memory Required**, (**Memory Available**), and **Enough slots for Samples & MS**, to

determine whether or not you need to free up room for the new .KSC.

## 2. Set the Load Method as desired.

This sets the preferred way to load the KSC's EXs and User Sample Bank data: load it into RAM, or use Virtual Memory. Note that if the data is extremely large, and would not fit into RAM even if no other samples were loaded, the data will be loaded into Virtual Memory regardless of this setting.

These settings apply only to EXs and User Sample Bank data; Sampling Mode data is always loaded into RAM.

**RAM:** The samples will be loaded into RAM. This has the advantage of allowing reverse playback.

**Virtual Memory:** The samples will use Virtual Memory. This generally allows you to load more large samples at once. Note that the samples may still require a significant amount of RAM.

**KSC Settings:** KSCs can store separate load method settings for each Multisample or Drum Sample, based on the settings when the KSC was saved. Setting **Load method** to **KSC Settings** uses these individual settings.

## 3. If the current directory contains a .PCG file, and .SNG file of the same filename, you can select the "Load \*\*\*\*\*.PCG too" check box, the "Load \*\*\*\*\*.SNG too" check box, and the "Load \*\*\*\*\*.KGE too" check box.

(See "Load: .PCG: 1")

- If you check "Load \*\*\*\*\*.PCG too," the .PCG file of the same name as the .KSC file will also be loaded. (See "Load .PCG: 2")
- If you check "Load \*\*\*\*\*.SNG too," the .SNG file of the same name as the .KSC file will also be loaded. (See "Load .PCG: 3")

## 4. To load the data, press the OK button. To cancel without loading, press the Cancel button.

If the .KSF files used by the .KMP file are not in the current directory or below it, a dialog box will appear, allowing you to specify the directory. For more information, see "If a file to be loaded cannot be found, or when loading a file that was saved across media" on page 829.

-  Since overflow checking of sample RAM is performed when loading each individual .KSF file, it is possible that an overflow may occur in the middle of the loading process.

## Loading individual files from within a .KSC file

Similar to .PCG files, you can browse inside a .KSC file as if it were a folder on the disk. You can use this to load individual Multisamples, Drum Samples, or Samples—including more than one at a time, using Multiple Select.

Groups of data appear with folder icons within the .KSC. As with folders on the disk, you can select one or more folders to load all of their contents, or open a folder to browse within.

The total size of all referenced files is shown to the right of each item's name.

When you open a .KSC file, you'll see folders for each EXs used by the .KSC. If the .KSC includes User Samples, there will also be a folder titled User Sample Data. The folder and file structure is as shown below.

User Sample Data folder

- Multisamples folder
    - Multisamples
      - Samples used by the Multisample
  - Un-referenced Samples folder
    - All samples not in Multisamples
- EXs(n) (Name)
- Multisamples folder
    - Multisamples
  - Drum Samples
    - List of Drum Samples

To load data from within a .KSC:

1. Use the **OPEN** and **UP** buttons to browse through the KSC's folders.
2. Select the data to load. Enable **Multiple Select** in order to select two or more items.
3. Press the **LOAD** button.
  - The Load Sample Data from KSC dialog will appear.
4. Set **Sample & MS allocation** to **Append**, **Clear Sampling Mode Data**, or **Clear All** as desired.
5. If you're loading EXs or User Sample Bank data, set the **Load Method** as desired.

For more information on the allocation and Load Method options, see "Load .KSC" on page 838.

Note the metrics in the dialog, which show the amount of memory required, the amount of memory available, and whether or not there are enough slots for the selected User data.

6. Press **OK** to load the data.

## Load .KMP



The selected .KMP file will be loaded as a multisample. The .KSF files used by the .KMP will also be loaded as samples.

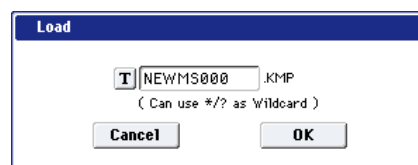

 The .KSF files used by the .KMP file will be saved in an automatically-created directory with the same name as the .KMP file.

1. To load the data, press the **OK** button. To cancel without loading, press the **Cancel** button.

Samples will be loaded starting at the first unoccupied number following the last multisample or sample that currently exists in the sample memory. Only valid multisamples or samples will be packed and loaded (Append load).

If the .KSF files used by the .KMP file are not in the current directory or below it, a dialog box will

appear, allowing you to specify the directory. For more information, see “If a file to be loaded cannot be found, or when loading a file that was saved across media” on page 829.

- Since sample RAM overflow checking is performed when loading each .KSF file, an overflow may occur during the loading process.

**Load .KSF** 

The selected .KSF file will be loaded as a sample.



- To load the data, press the OK button. To cancel without loading, press the Cancel button.

The sample will be loaded after the last Multisample or Sample that currently exists in Sampling Mode (similar to loading with the Append option).

**Loading AIFF and WAVE files**

The KRONOS can load AIFF format or WAVE format files, which are formats used to save audio data on personal computers etc. When this data that has been loaded, it can be used as a sample or a drum sample.

- Files with an extension of other than .AIF/.WAV cannot be recognized as AIFF/WAVE files. In this case, use the Utility “Rename” menu command to change the last four characters of the filename to “.AIF”/“.WAV”
- If the data that is loaded as a sample contains a loop point, you can set **Start Offset** (Program 1–2a) on the KRONOS so that the sound will begin from the loop point.
- If data whose sample size is 8 bits or less is loaded, it will be converted into 16 bit data inside the KRONOS. This will mean that the amount of internal memory consumed will be approximately twice as large as the file size. The increase in size resulting from this conversion may mean that it is impossible to save that data on a media.

**Load .AIF** 

The selected AIFF file will be loaded as a sample.



- To load the data, press the OK button. To cancel without loading, press the Cancel button.

The sample will be loaded after the last Sample that currently exists in Sampling Mode (similar to loading with the Append option).

*Note:* You can load multiple files at once, as long as they are in the same directory. See “Multiple Select” on page 818 and “Loading multiple files at once” on page 837

**Load .WAV** 

The selected WAVE file will be loaded as a sample.

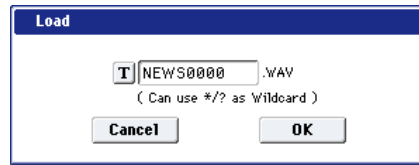

- To load the data, press the OK button. To cancel without loading, press the Cancel button.

The sample will be loaded after the last Sample that currently exists in Sampling Mode (similar to loading with the Append option).

*Note:* You can load multiple files at once, as long as they are in the same directory. See “Multiple Select” on page 818 and “Loading multiple files at once” on page 837

**Loading AKAI S1000/S3000 format Sample files, Program files, or Volumes**

The KRONOS can load AKAI S1000/S3000 format Samples, Programs, and Volumes. The sounds can then can be used in Sampling Mode, and saved as User Sample Banks.

The AKAI format uses the concept of “key groups.” For each key zone, up to four samples can be assigned, and these four can be switched or crossfaded by velocity. Key zones can also be crossfaded.

If you load an AKAI Program file into the KRONOS with **Advanced Conversion Load** turned off, a single sample will correspond to each key zone, meaning that a maximum of four multisamples will be used to create a key map in the velocity order of each key group. Also, key zones will not be crossfaded.

- When you load Program file data, settings such as key group, key group zone, oscillator, pitch, filter, amp/pan, and EG are supported, and can be converted into a KRONOS program, or programs + combination.
- When you load a Volume, all Program files and Sample files included in the Volume can be loaded together.
- AKAI S1000/S3000 format stereo Sample files and Program files whose names end in “-L” and “-R” can be loaded into the KRONOS as stereo samples and multisamples.

When the above files are loaded, “-L” and “-R” will automatically be moved to the end of the sample name or multisample name (23 and 24 character) so that they can automatically be recognized as stereo samples or multisamples.

## Load AKAI Sample File



The selected Sample will be loaded as a sample.

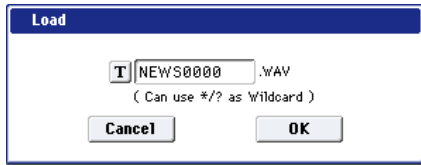

1. To load the data, press the OK button. To cancel without loading, press the Cancel button.

The sample will be loaded after the last sample that currently exists in Sampling Mode (similar to loading with the Append option). If you save the data, it will be stored in Korg format. It is also possible to export as a .AIF or .WAV file; see "Export Samples as AIF/WAV".

*Note:* You can load multiple files within the directory. (See "Multiple Select" on page 818, "Loading multiple files at once" on page 837)

- ⚠ If the data that is loaded as a sample contains a loop point, you can set **Start Offset** (Program2-1c) on the KRONOS so that the sound will begin from the loop point.

*Note:* If the end (19 and 20 characters) of the sample name is "-L" and "-R," the "-L" and "-R" will automatically be moved to the end of the KRONOS's sample name (23 and 24 characters).

When you load two files whose sample names are identical except for ending in "-L" and "-R," and assign them to a stereo multisample in Sampling mode, they will be recognized as a stereo sample.

### Akai S1000/S3000 Loop Conversion

In rare cases, loops from Akai samples may need to be changed when loaded into the KRONOS:

- Some Akai samples may contain multiple loops. If this is the case, KRONOS will use the first HOLD loop, if present. If there is no HOLD loop, KRONOS will use the longest loop.
- Some Akai samples may have loop lengths with a resolution of less than a single sample. In this case, KRONOS will round the loop to the nearest sample.

## Load AKAI Program File



The selected Program file will be loaded as a KRONOS program, or converted and loaded as programs + combination. You also have the option of loading only as multisamples and samples.

1. Select an AKAI Program file in the directory window.
2. Select the page menu command "Load selected" to open the dialog box.

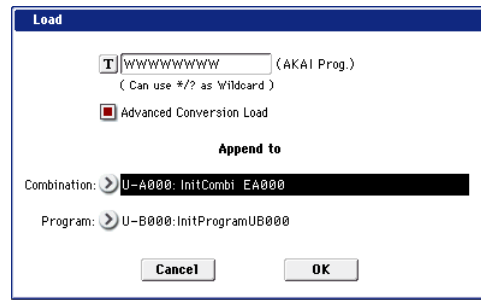

3. In "Advanced Conversion Load," select how the AKAI Program file will be loaded.

**On (checked):** Program file parameters such as key group, key group zone, oscillator, pitch, filter, amp/pan, LFO, and EG will be converted into a KRONOS program or programs and combination.

**Off (unchecked):** The selected Program file will be loaded as a multisample. Only the keymap-related parameters within the Program file will be loaded to create the multisample.

4. If you checked "Advanced Conversion Load," use "Append to: Combination" to specify the destination bank and number of the combination that will be created by the convert-load operation.

When you execute the command, the combinations that are created will be loaded starting at the bank and number you specify here.

5. If you checked "Advanced Conversion Load," use "Append to: Program" to specify the destination bank and number of the program that will be created by the convert-load operation.

When you execute the command, the programs that are created will be loaded starting at the bank and number you specify here.

*Note:* The Multisamples and Samples will be loaded after the last Multisample and Sample currently existing in Sampling Mode, like loading with the Append option.

*Note:* If the Sample files used by the Program file are not in the current directory or below it, a dialog box will appear, allowing you to specify the directory. For more information, see "If a file to be loaded cannot be found, or when loading a file that was saved across media" on page 829.

- ⚠ Since sample RAM overflow checking is performed when loading each sample file, an overflow may occur during the loading process.

*Note:* If a loaded multisample is assigned samples whose sample names end in "-L" and "-R," an "-L" and "-R" will automatically be added to the end (23 and 24 characters) of the multisample name.

*Note:* When you load two multisamples whose multisample names are identical except for ending in "-L" and "-R," they will be recognized in Sampling mode as a stereo multisample.

- ⚠ Depending on the structure of the AKAI Program, the data may be converted into two or more programs and one combination when it is loaded. In this case, the number of programs created is limited to a maximum of sixteen (the maximum number of programs usable in a combination), and the



message “Exceeded 16 Programs” may appear. Please be aware of this when loading complex AKAI Program data.

- 🔍 If the loading-destination bank and number exceed USER-G127, loading will automatically stop.
- 🔍 The data in the locations following the specified bank/number will be rewritten when you load. If you want to keep this data, use **Save All** or **Save PCG** before you load the AKAI Program data.

### Load AKAI Volume



You can load Program files and Sample files in a single operation from a Volume on an AKAI S1000/S3000 format sample CD. On AKAI S1000/S3000 format sample CDs, the Program files and Sample files are organized into Partitions and Volumes (see “Files, directories, and icons” on page 815).

1. In the 0-1: Load page, use “Drive Select” to select the AKAI S1000/S3000 format media.
2. In the directory window, select the desired AKAI S1000/3000 format volume.
3. Select the page menu command “Load selected” to open the dialog box.

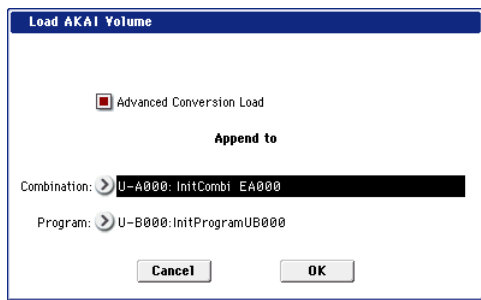

4. If you check “Advanced Conversion Load,” all Sample files included in the selected volume will be loaded as samples.

Program file settings such as key group, key group zone, oscillator, pitch, filter, amp/pan, and EG will be converted into a KRONOS program, or into programs and a combination. (Multisamples will also be convert-loaded.)

If you don’t check this, all Sample files included in the selected volume will be loaded as samples, and the Program file will be loaded as a multisample. Only the keymap-related parameters from the Program file will be loaded to create a multisample.

5. If you checked “Advanced Conversion Load,” use “Append to: Combination” to specify the destination bank and number of the combination that will be created by the convert-load operation.

When you execute the command, the combinations that are created will be loaded starting at the bank and number you specify here.

6. If you checked “Advanced Conversion Load,” use “Append to: Program” to specify the destination bank and number of the program that will be created by the convert-load operation.

When you execute the command, the programs that are created will be loaded starting at the bank and number you specify here.

- 🔍 If the loading-destination bank and number exceed USER-G127, loading will automatically stop.
- 🔍 The data in the locations following the specified bank/number will be rewritten when you load. If you want to keep this data, use **Save All** or **Save PCG** before you load the AKAI Volume data.

### Loading SoundFont 2.0 format files

SoundFont 2.0 is a file format that includes sound parameters with the sample data, and is widely supported in the multimedia field as well as by many software synthesizers and software samplers.

SoundFont 2.0 files may contain a number of different sounds—not just a single sound. When you load a SoundFont 2.0 file into the KRONOS, all of the file’s sounds will be loaded together.

*Note:* The entire file is always loaded. If you only want particular sounds from the SoundFont file, delete them before saving the KSC file to disk.

- Sound parameters such as key group, key group zone, oscillator, pitch, filter, amp/pan, LFO, and EG are supported, and will be converted to a KRONOS program or a combination and programs as they are loaded.
- Sample data will be converted into Multisamples and Samples, and loaded into Sampling Mode.

*Note:* Multisamples, Programs, and Combinations are given the name of the SoundFont 2.0 file with a numbered suffix. When sounds are converted to Combinations, the Programs used in those Combinations will be given an asterisk (\*) before the name.

If sample data that has the same settings is used in more than one item of sound data in a SoundFont 2.0 file, the sample data will be loaded into the first-loaded multisample, and will not be loaded into other multisamples. In such cases, please note that the program after loading will be assigned differently-named multisamples.

*Note:* If a loaded multisample assigns stereo samples, an “-L” and “-R” will be automatically added to the end of the multisample name and sample name (the 23rd and 24th characters).

*Note:* If two identical multisamples whose file names differ only by ending in “-L” and “-R” are loaded, Sampling mode will recognize them as a stereo multisample.

- 🔍 In some cases depending on the structure of the sound data, the data will be converted into multiple programs and one combination when you load it. In this case, the maximum number of programs following conversion is limited to the sixteen programs that a combination can use, and a message of “Exceeded 16 Programs - some data not loaded” may appear. Please be aware of this when loading complex sound data structures.
- 🔍 SoundFont 2.0 files may contain sound data that is assigned to use ROM sample data from a specific sound card. In this case, the sample data will not be included in the SoundFont 2.0 file, and so the sound will not play correctly.

 SoundFont 2.0 files may contain sound data that is assigned to use effects from a specific sound card or sampler program. These effect settings will not be loaded.

 SoundFont 2.0 files may use sample data of a sampling frequency not supported by the KRONOS. In this case, the Pitch parameter for each Index of the multisample will be set automatically in order to correct the playback pitch. Since the Pitch parameter is set in units of a cent, the pitch may not be accurate. If you use the loaded sample in another multisample or drum kit, you must use the multisample's Pitch parameter or the drum kit's Transpose and Tune parameters to adjust the pitch.

**Load SoundFont 2.0 File**

This command loads the selected SoundFont 2.0 file.

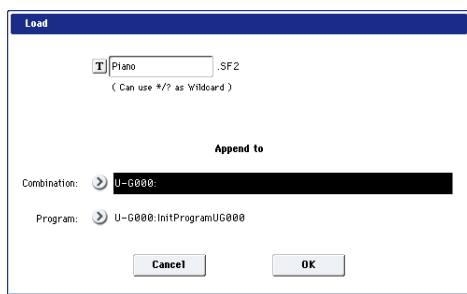

1. Use "Append to: Combination" to specify the destination bank and number of the combination that will be created by the convert-load operation.

When you execute this command, the created combination(s) will be loaded starting at the bank and number you specify here.

2. Use "Append to: Program" to specify the destination bank and number of the program that will be created by the convert-load operation.

When you execute this command, the created program(s) will be loaded starting at the bank and number you specify here.

*Note: Note:* The Multisamples and Samples will be loaded after the last Multisample and Sample currently existing in Sampling Mode, like loading with the Append option.

 Since an overflow check for the user sample RAM is performed when loading each individual sample file, it is possible for an overflow to occur during the load operation.

**Load .KGE** 

This command loads all data from the .KGE file.

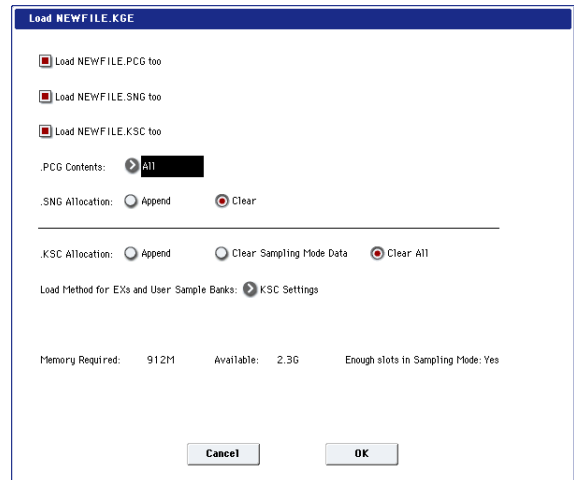

1. If you want to load the .PCG, .SNG, and .KSC file of the same name as the .KGE file along with the .KGE file, select the "Load \*\*\*\*\*.PCG too," "Load \*\*\*\*\*.SNG too," and "Load \*\*\*\*\*.KSC too" check boxes.

For more information on the various options, see "Load .KSC" on page 838, "Load .SNG" on page 833, and "Load .PCG" on page 829.

2. Press the OK button to load, or press the Cancel button if you decide not to load.

**Load GEs** 

This command loads all GE data from the .KGE file.

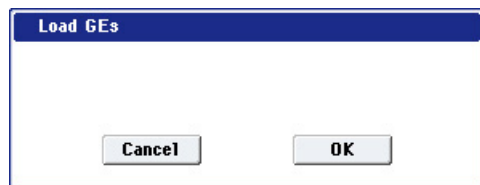

1. Press the OK button to load, or press the Cancel button if you decide not to load.

**Load GE Bank** 

This command loads all GE data from a .KGE file.

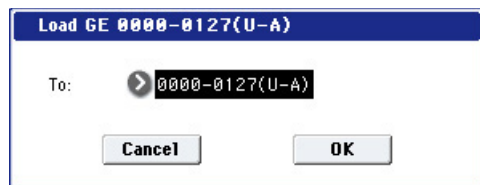

1. Use the "To" field to specify the load-destination bank.
2. Press the OK button to load, or press the Cancel button if you decide not to load.

Note: If **Multiple Select** is enabled, and you select more than one bank, they will be loaded starting at the bank specified by the To field.

### Load a single GE



This command loads the selected GE data into the GE number you specify as the load-destination.

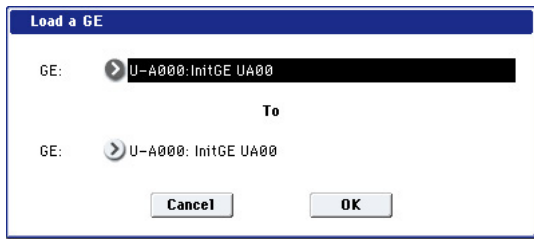

1. If you want to load a GE other than the selected one, use the “GE” field (upper line) to re-select the program to be loaded. Press the popup button, and “GE Select” will appear.
2. Use the “To GE” field (lower line) to select the load-destination bank and program. Press the popup button, and “GE Select” will appear.

Note: If you check “Multiple Select” (0-1a) and select more than one GE, they will be loaded starting at the GE specified by the “To” field.

3. Press the OK button to load, or press the Cancel button if you decide not to load.

### Load Templates



This command loads all template data from the .KGE file. This is user template data such as the rhythm patterns and CC patterns used by user GEs.



1. Press the OK button to load, or press the Cancel button if you decide not to load.

### Load Template Bank



This command loads the template data from the selected bank into the bank you specify as the load-destination.

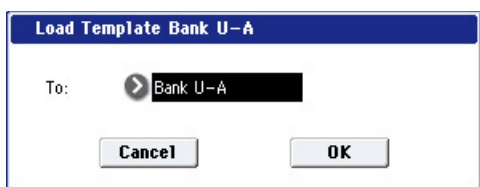

1. Use the “To” field to specify the load-destination bank.
2. Press the OK button to load, or press the Cancel button if you decide not to load.

Note: If Multiple Select is enabled, and you select more than one bank, they will be loaded starting at the bank specified by the To field.

### Load PCG (RAM) and Samples

Load PCG (RAM) and Samples loads only the Programs, Wave Sequences, and Drum Kits that use Sampling Mode data, as well as the Combinations or Songs that use these Programs. This is useful when you are editing Programs and Combinations that use Sampling Mode data.

Optionally, you can also load all the Programs used by the loaded Combinations and Songs, even if they don't use Sampling Mode data.

The Programs and Combinations will be loaded in order from the bank and number you specify.

### Content loaded from the .PCG file

This command loads:

- Drum Kits or Wave Sequences which use at least one Sampling Mode Sample or Multisample.
- Programs which use at least one Sampling Mode Multisample, or one Drum Kit or Wave Sequence as described above.
- Combinations which use at least one Program as described above.

### Content loaded from the .SNG file

The command also loads Songs which use at least one Program as described in (2), above.

These Songs will be loaded into vacant numbers starting after the last Song in internal memory. For more information, see “.SNG Allocation” on page 830.

### Automatic reassignment of banks and numbers

When loading, the banks and numbers for all data will be adjusted automatically so that all references work correctly. This includes:

- Sampling Mode Samples used by Multisamples and Drum Kits
- Sampling Mode Multisamples used by Programs and Wave Sequences
- Drum Kits and Wave Sequences used by Programs
- Programs used by Combinations or Songs

1. Select a .PCG file in the directory window.

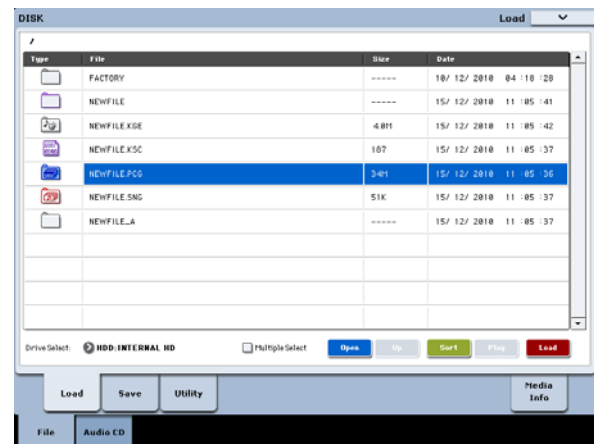

2. Select this command to display the dialog box.

This command will be available only if you've selected a .PCG file.



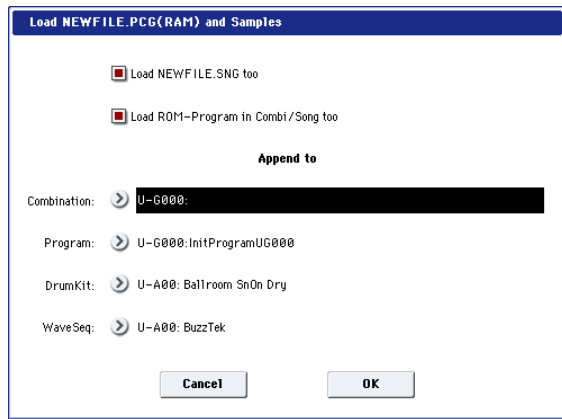

3. If you also want to load the .SNG file of the same name as the .PCG file, check the “Load \*\*\*\*\*.SNG too” check box.

*Note:* The .KSC file of the same filename as the .PCG file will be loaded together with the .PCG file. If the file does not exist in the current directory, load the file as described in “If a file to be loaded cannot be found, or when loading a file that was saved across media” on page 829.

4. If you check “Load ROM-Program in Combi/Song too,” ROM-based programs in the .PCG file combinations or .SNG file songs will be loaded together with the Programs which use Sampling Mode data.

Choose this setting if the Combinations or Songs being loaded rely on both user and preload Programs. This is the default.

If you leave this unchecked, only Programs, Drum Kits, and Wave Sequences which use Sampling Mode data will be loaded, along with any Combinations or Songs which use those Programs.

(To ensure that those Combinations and Songs sound correctly, all Programs that they require will also be loaded, even if they use only ROM data.)

- Program data whose bank type is EXi will not be loaded.

5. Use “Append to: Combination” to specify the loading-destination bank and number for the combinations in the .PCG file.

When you execute, only the applicable combinations will be loaded into consecutive numbers starting at the bank and number you specify here.

6. Use “Append to: Program” to specify the loading-destination bank and number of the programs in the .PCG file.

When you execute, only the applicable programs will be loaded into consecutive numbers starting at the bank and number you specify here.

If the loading-destination bank and number exceed N127, loading will automatically stop.

- If the load-destination bank and number in steps 5 and 6 exceeds USER-G127, the load operation will end automatically.

7. Use “Append to: Drum Kit” to specify the loading-destination number for the drum kits in the .PCG file.

When you execute, only the applicable drum kits will be loaded into consecutive numbers starting at the number you specify here.

8. Use the Append to “Wave Sequence” field to specify the load-destination number for the wave sequences in the .PCG file.

When you execute the command, only the valid wave sequences will be loaded starting at the number you specify, and occupying each consecutive number.

- If the load-destination bank and number in steps 7 and 8 exceeds USER-G15–USER-G31 respectively, the load operation will end automatically.

- The data in the locations following the specified bank/number will be rewritten when you load. If you want to keep this data, use **Save All** or **Save PCG** before you load the new data.

9. Press the OK button to load the data. If you decide not to load, press the Cancel button.

### Cautions regarding Save

- When saving combinations with **Save All**, **Save PCG & SNG**, or **Save PCG**, you should also try to save the programs used by each timbre (and the drum kits, wave sequences used by the programs) at the same time.

Similarly, when saving programs, you should also save the drum kit, wave sequence used by the program and the wave sequence at the same time.

- If multisamples or samples created in Sampling mode are used in a program or drum kit, we recommend that you save the data using **Save All**.

Also when using **Save PCG** or **Save Sampling Data** to save an individual program, drum kit, or multisample or sample created in Sampling mode, we recommend that you save the data in the same directory with the same filename.

When using **Load PCG** to load a .PCG file, the .KSC file of the same name will be loaded at the same time so that the multisamples/samples that were saved with the program or drum kit will correspond correctly.

### If the data being saved does not fit on one volume of media

When saving a .PCG, .KSC, .KMP, or .KSF file, and the data does not fit on one volume of media, the display will ask “No space available on medium. Do you want to make a divided file?”

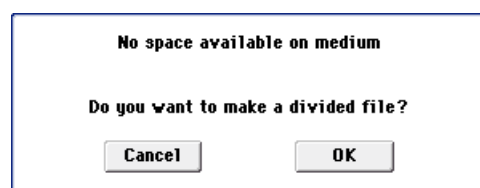

1. To save the data as a divided file across two or more volumes of media, make sure that you have the required number of discs, and then press the OK button in the “No space available on medium” dialog box. Saving will begin.

If you decide that you don't want to save a divided file, press the Cancel button, and save your data to media that has more available space.

**2. When a volume of media fills up during the save, the following dialog box will appear.**

Insert the next volume of media and press the LCD screen to make the KRONOS detect the media, or use "Drive Select" (0-1a) to specify the save-destination media.

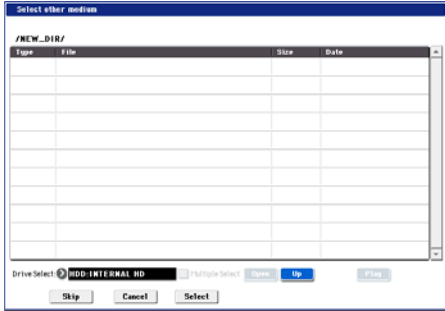

**3. Press the Select button to continue saving. If the "No space available on medium" dialog box appears again, repeat steps 1-3.**

Saving will be halted if you press the Cancel button. If you then want to abort the save operation, press the OK button in the dialog box. If you press the Skip button, the indicated file will be skipped, and the next file will be saved.

**Save All (PCG, SNG and KSC)**

Here's how to save the following data from internal memory to media.

.PCG file: Programs, combinations, drum kits, wave sequences, global settings

.SNG file: Songs, region data

.KSC file: References to Multisamples, Samples, and Drum Samples from Sampling Mode, EXs, or User Sample Banks

.KGE file: User GEs

This command is valid only when the current directory is a DOS directory.

**1. Select Save All to open the dialog box.**

Save All (PCG, SNG and KSC)

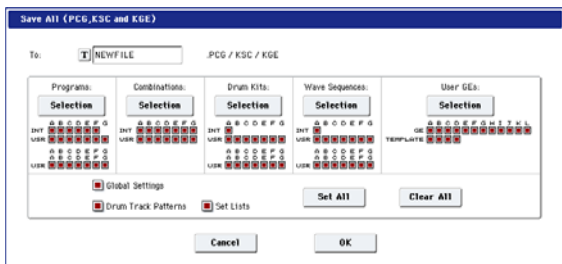

**2. Use the text edit button to move to the text input dialog box, and specify the filename.**

For example if you specify NEWFILE and execute the save command, files named NEWFILE.PCG, NEWFILE.SNG, NEWFILE.KSC, and NEWFILE.KGE will be saved to the media.

**3. Select the bank(s) that you want to save.**

Programs, combinations, drum kits, wave sequences, and user GE can be saved in units of banks. Information on the bank to be saved is displayed below each Selection button. Banks that are checked will be saved.

If you want to modify the selections, press the Selection button to open the dialog box, and check the check boxes for the data you want to save.

Example: when the Selection button for Program is pressed

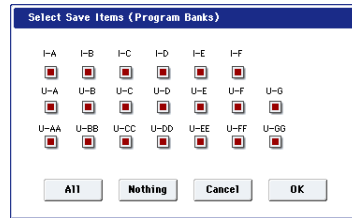

If you press the All button, all banks will be checked.

If you press the Nothing button, all banks will be unchecked.

Press the OK button to change the selections as specified, or press the Cancel button to discard your changes.

To specify whether "Global Settings" will be saved, use the check box in step 1.

**4. To save the data, press the OK button. To cancel without saving, press the Cancel button.**

If the error message "No space available on medium" appears, see "If the data being saved does not fit on one volume of media" on page 845.

When you save, files will be created in the current directory. If the data you save extends across two or more media, these files will be divided. In addition to the .PCG, .SNG, and .KSC files that will be created with the specified filename, one directory will also be created. The files listed in NEWFILE.KSC will be saved in this directory.

In addition to the .PCG, .SNG, .KSC, and .KGE files created with the specified filename, two directories will also be created.



One directory will have the "specified filename" as its directory name, and will contain the files listed in .KSC. (File: purple)



The other directory will have "(specified filename)\_A" as its directory name, and will contain the WAVE files used by the regions of each audio track in each song. (File: red)

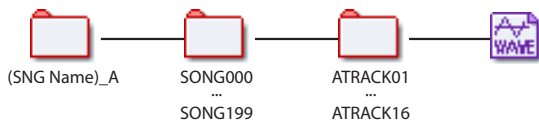

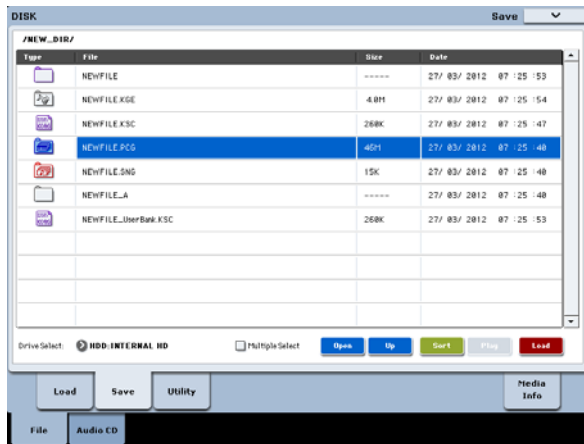

### Save PCG & SEQ

This command saves all internal memory programs, combinations, drum kits, wave sequences, and global settings as a .PCG file, and saves songs and regions data to a .SNG file on the specified media.

This command is valid only when the current directory is a DOS directory.

1. Select "Save PCG & SEQ" to open the dialog box.

*Save PCG & SEQ Data*

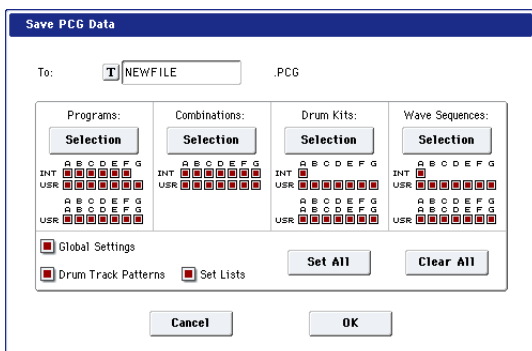

2. Use the text edit button to move to the text input dialog box, and specify the filename.  
For example if you specify NEWFILE and execute the save command, files named NEWFILE.PCG and NEWFILE.SNG will be saved to the media.
3. Select the bank(s) that you want to save.  
For more information, see "Save All (PCG, SNG and KSC)" on page 846.
4. To save the data, press the OK button. To cancel without saving, press the Cancel button.

A directory will be created in addition to the .PCG and .SNG files created with the specified filename.



The directory will have "(specified filename)\_A" as its directory name, and will contain the WAVE files used by the regions of each audio track in each song. (File: red)

Note: Some Global settings are not saved, including:

- Memory Protect settings
- System Clock setting

### Save PCG

This command saves all internal memory programs, combinations, drum kits, wave sequences, and global settings as a .PCG file.

This command is valid only when the current directory is a DOS directory.

1. Select "Save PCG" to open the dialog box.

*Save PCG Data*

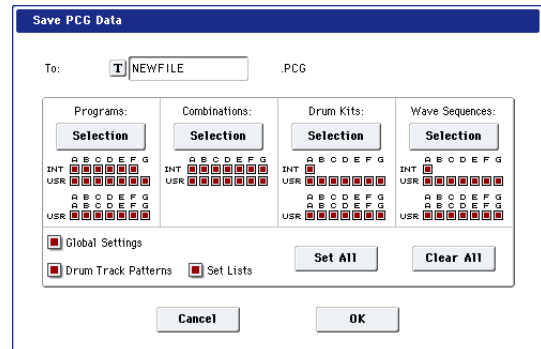

2. Use the text edit button to move to the text input dialog box, and specify the filename.

For example if you specify NEWFILE and execute the save command, a file named NEWFILE.PCG will be saved to the media.

3. Select the bank(s) that you want to save.

For more information, see "Save All (PCG, SNG and KSC)" on page 846.

4. To save the data, press the OK button. To cancel without saving, press the Cancel button.

### Save SEQ

This command saves all songs and regions data from internal memory as a .SNG file.

This command is valid only when the current directory is a DOS directory.

1. Select "Save SEQ" to open the dialog box.

*Save Songs and Regions Data*

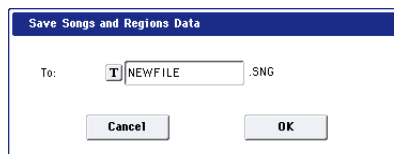

2. Use the text edit button to move to the text input dialog box, and specify the filename.

For example if you specify NEWFILE and execute the save command, a file named NEWFILE.SNG will be saved to the media.

3. To save the data, press the OK button. To cancel without saving, press the Cancel button.

A directory will be created in addition to the .SNG file created with the specified filename.



The directory will have "(specified filename)\_A" as its directory name, and will contain the WAVE files used by the regions of each audio track in each song. (File: red)

## Save Sampling Data

This is valid only when the current directory is a DOS directory. It lets you save any Sampling Mode data (either created through sampling, or previously loaded from disk), the current set of loaded EXs and User Sample Bank data, or both. In most cases a .KSC file is also created; see “What’s a KSC file?” below.

Sampling Mode Multisamples and Samples are saved as Korg format .KMP and .KSF files, respectively.

### What’s a KSC file?

KSC stands for Korg Sample Collection. .KSC files contain links to Sampling Mode, EXs, and/or User Sample Bank data, including Multisamples, Samples, and Drum Samples. Loading a .KSC file loads all of the linked data.

If a .KSC includes links to Sampling Mode data, other .KSC files can link to *that* .KSC as a User Sample Bank.

### Saving Sampling Mode data creates two KSC files

When you save a KSC which includes Sampling Mode data, two KSC files are created:

- A KSC with the name you’ve specified, which includes the actual Samples and Multisamples from Sampling Mode.
- A second KSC which includes links to the first KSC’s Sampling Mode Data, with Load Method set to Virtual Memory. The name for this KSC is the name you’ve specified followed by the text “\_UserBank.” For instance, if the first KSC is named BillGig.KSC, the second will be BillGig\_UserBank.KSC. This is the file that you’ll load to access the sample data as a User Sample Bank.

Both files may contain references to other EXs or User Sample Banks, depending on the setting of the **Include** parameter in the Save dialog.

For more information on User Sample Banks, see “User Sample Banks” on page 154 of the Operation Guide.

### Using Save Sampling Data

1. Select “Save Sampling Data” to open the dialog box.

*Save Multisamples and Samples Data*

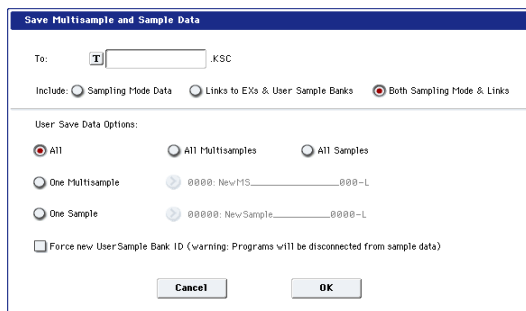

2. Press the text edit button to open the text dialog box, and enter the desired file name.
3. Use “Include” to specify whether to save Sampling Mode data, references to EXs and User Sample Banks, or both.

4. Under “User Sample Data options,” specify which parts of the Sampling Mode data will be saved. Use the following five radio buttons to make your selection.

**All:** This is the default; it saves all Multisamples and Samples from Sampling Mode (as .KMP and .KSC files, respectively), inside a directory with the name entered above. KSC files are also created, as described under “Saving Sampling Mode data creates two KSC files,” above.

**All Multisamples:** Only the Multisamples from Sampling Mode, along with any Samples that they use, will be saved (as .KMP and .KSC files, respectively) inside a directory with the name entered above. Any Samples not used by Multisamples will not be saved. KSC files are also created, as described under “Saving Sampling Mode data creates two KSC files,” above.

**All Samples:** All samples will be saved as .KSF files, inside a directory with the name entered above. KSC files are also created, as described under “Saving Sampling Mode data creates two KSC files,” above.

**One Multisample:** The selected Multisample will be saved as a .KMP file. Simultaneously, a directory will also be created, and the Samples used by the Multisample will be saved in that directory.

The names of both the file and the directory will be set to the first five characters (uppercase) of the sixteen-character Multisample name, followed by the Multisample number. If the Multisample number is greater than 999, only the first four characters will be used. For example:

000: NewMS\_\_\_\_\_000 → NEWS000.KMP

001: 108bpmDrLoop00 → 108BP001.KMP

**One Sample:** The selected sample will be saved as a .KSF file.

The filename will automatically be set to the first four characters (uppercase) of the sixteen-character Sample name, followed by the Sample number. If the number is greater than 9,999, only the first three characters will be used. For example:

0000: NewSample\_0000 → NEWS0000.KSF

0001: C#3-EGuitar → C#3-0001.KSF

*Note:* If you wish to export the data in AIFF (.AIF) or WAVE (.WAV) format, use the menu command **Export Samples as AIF/WAV** instead.

5. In general, leave “Force new User Sample Bank ID” un-checked.

This should be used only in special cases.

For instance, you might use **Force new User Sample Bank ID** if you have loaded a User Sample Bank, edited it substantially, and wish to save the result as a totally new User Sample Bank. After doing so, you’ll also need to use the Remap MS/Sample Bank References menu command to assign Programs, Wave Sequences, or Drum Kits to use the new bank instead of the old one.

For more information, see “User Sample Bank IDs” on page 156 of the Operation Guide.

6. To save the data, press the OK button. To cancel without saving, press the Cancel button.

Note: If the **Translation** menu command is enabled, .KMP and .KSF files will be shown with their full sixteen-character Multisample or Sample names, as opposed to the abbreviated 8.3-character file names.

### Save User GE

This command saves all user GEs and user template data from internal memory to media as a .KGE file. This is available only if the current directory is a DOS directory.

1. Choose "Save User GE" to access the dialog box.

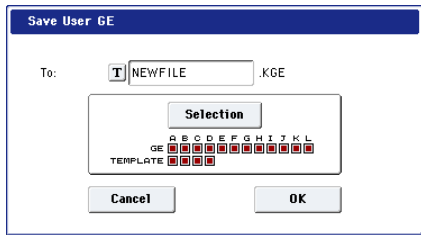

2. Use the text edit button to access the text entry dialog box, and specify a file name.

For example if you specify NEWFILE and execute the save, the file NEWFILE.PCG will be saved to media.

3. Select the GE and template banks that you want to save. (For details, refer to "Save All, step 3.")

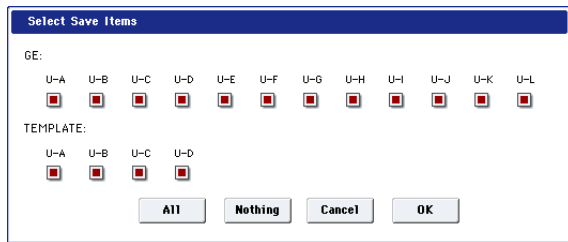

4. Press the OK button to save, or press the Cancel button if you decide not to save.

### Save to Standard MIDI File

This command saves the selected song from internal memory to storage media as a .MID file (Standard MIDI File). This command is valid only when the current directory is a DOS directory.

Note: This applies only to MIDI track data. Audio track data will not be saved.

1. Select "Save to Standard MIDI File" to open the dialog box.

Save Song as Standard MIDI File

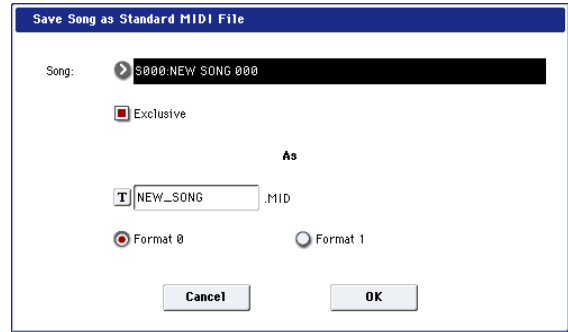

2. In Song, so the song that you wish to save.
3. If "Exclusive" is On (checked), System Exclusive events and Universal Exclusive events included in the song data will be saved as exclusive messages.

If this is Off (unchecked), system exclusive events and universal exclusive events included in the song data will not be saved.

4. Use the text edit button to access the text input dialog box, and specify the filename. By default, the first eight characters (uppercase) of the song name will be assigned automatically.
5. Use the radio buttons to specify the format.

**Format 0** will save sixteen channels of MIDI data together in a single track.

**Format 1** will save each MIDI channel to a separate track.

6. To save the data, press the OK button. To cancel, press the Cancel button.

The song data (MIDI track data) you save here can be played back on a device that supports Standard MIDI Files. However if you intend to playback the data on the KRONOS, we recommend that you use "Save SEQ" to save the data, since this will allow a higher degree of reproducibility.



## Save Exclusive

This command first captures incoming MIDI System Exclusive data (SysEx), and then saves the data as an .EXL file.

This command is valid only when the current directory is a DOS directory.

1. When you select “Save Exclusive,” the KRONOS will wait for incoming MIDI SysEx data. The following dialog box will appear.

Receive and Save MIDI System Exclusive Data

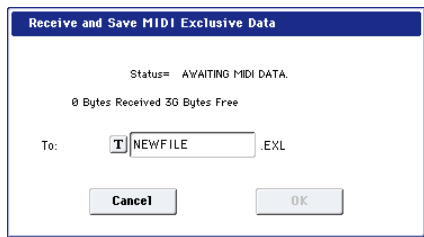

2. Transmit the exclusive data that you wish to save to the KRONOS.

While the data is being received, the display will indicate “Status=RECEIVING MIDI DATA.” When reception ends, the size of the received data and the size of the remaining free area will be rewritten. The display will change to “Status=AWAITING MIDI DATA,” and you can continue transmitting exclusive data to the KRONOS. During reception, the Cancel button and the OK button cannot be pressed.

3. Press the text edit button to access the text input dialog box, and specify the filename.
4. To save the data, press the OK button. To cancel without saving, press the Cancel button.

## Save Effect Preset

Effect preset data will be saved to media as a .KFX file.

This is valid only if the current directory is a DOS directory.

1. Select “Save Effect Preset” to open the dialog box.

Save Effect Preset

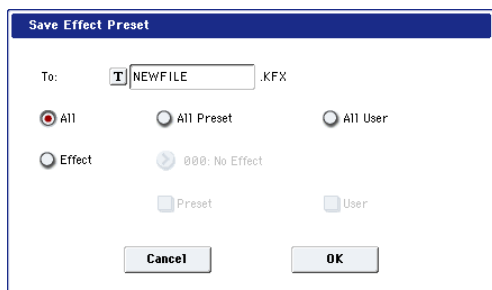

2. Press the text edit button to open the text input dialog box, and specify a filename.

For example if you specify NEWFILE and then execute, NEWFILE.KFX will be saved to media.

3. Specify the contents that will be saved. Choose one of the following five radio buttons.

**All:** Preset data (P01–P15 and U00–U15) for all effects will be saved as a .KFX file.

**All Preset:** Preset data P01–P15 for all effects will be saved as a .KFX file.

**All User:** Preset data U01–U15 for all effects will be saved as a .KFX file.

**One Effect:** Only the preset data of the selected effect will be saved as a .KFX file. If you check Preset, P01–P15 will be saved; if you check User, U01–U15 will be saved.

4. Press the OK button to save the data, or press the Cancel button to cancel without saving.

## Export Samples as AIF/WAV

Sampling Mode data can be exported to media as AIFF or WAVE format sample files.

This is valid only when the current directory is a DOS directory.

*Note:* Normally, it is recommended that you use Save All or Save Sampling Data to save sample data in Korg format (.KSC, .KMP, .KSF). This preserves all of the parameters of the Multisamples and Samples for use in Programs, Wave Sequences, and Drum Kits.

Use **Export Samples as AIF/WAV** if you wish to use an AIFF or WAVE format compatible application on your computer to work with samples that were recorded or edited on the KRONOS.

**Export Samples as AIF/WAV** does not export multisample files. The exported AIFF or WAVE format samples can be re-loaded, but if the sample number when saving is different than the sample number when loading, you may need to re-make certain settings, such as selecting the sample for each index of a multisample.

Furthermore, the following sample parameters are not preserved when using **Export Samples as AIF/WAV**:

- Sample Name
- Loop Tune (see “Loop Tune” on page 701)
- Reverse (see “Reverse” on page 701)
- +12dB (see “+12dB” on page 701)

Stereo samples will be exported as two independent L and R files.

1. Select “Export Samples as AIF/WAV” to open the dialog box.

Export Samples as AIFF/WAVE



2. In “Format,” select either AIFF or WAVE as the file format for export.

3. Press the text edit button to move to the text dialog box, and specify the filename.
4. In "To," specify the content that will be exported.

**All Samples:** All samples will be exported.

Filenames will automatically be set to the first four characters (uppercase) of the sixteen-character Sample name, followed by the Sample number. If the number is greater than 9,999, only the first three characters will be used. For example:

0000: NewSample\_0000→NEWS0000.AIF

0001: C#3-EGuitar→C#3-0001.WAV

**Samples in One MS:** All samples used by the selected multisample will be exported.

Filenames will automatically be set to the first five characters (uppercase) of the sixteen-character Multisample name, followed by the index number of the Sample within the Multisample (001-128). For example:

000: NewMS\_\_000:

Sample selected for index 001 → MS000001.AIF

Sample selected for index 002 → MS000002.AIF

001: 108bpmDrLoop00:

Sample selected for index 001 → MS001001.AIF

Sample selected for index 002 → MS001002.AIF

When exporting All Samples or Samples in One MS, and all of the sample data does not fit on one volume of media, another dialog box will appear, directing you to specify the next media. (See "If the data being saved does not fit on one volume of media" on page 845.) However at this time if a single sample is larger than the capacity of the media, the sample cannot be exported. Either specify media with a larger capacity, or press Skip button to omit exporting that sample and proceed to exporting the next sample.

**One Sample:** The single selected sample will be exported.

The filename will automatically be set to the first four characters (uppercase) of the sixteen-character Sample name, followed by the Sample number. If the number is greater than 9,999, only the first three characters will be used.

When exporting One Sample, it is not possible to export sample data that will not fit on one volume of media.

5. To export the data, press the OK button. To cancel without exporting, press the Cancel button.

## Save Audio CD Track List

This command saves an audio CD track list that you created in the Make Audio CD page. The drive and directory locations that contain each WAVE file, and the names of the WAVE files will be saved.

This command is valid only when the current directory is a DOS directory.

1. Select "Save Audio CD Track List" to open the dialog box.

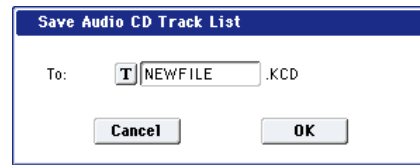

2. Use the text edit button to move to the text input dialog box, and specify the filename.  
For example if you specify NEWFILE and save, NEWFILE.KCD will be saved to the media.
3. Press the OK button to save, or press the Cancel button to cancel without saving.

## Rename

This command renames the selected file or directory.

This command is valid only when a DOS file or a DOS directory is selected.

1. Select the file or directory whose name you want to edit.
2. Select "Rename" to open the dialog box.

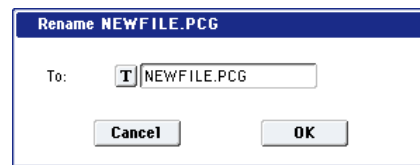

3. Press the text edit button to access the text input dialog box, and modify the name.
4. To rename the file or directory, press the OK button. To cancel, press the Cancel button.

## Copy

This command is valid only when a DOS file or a DOS directory is selected.

1. Select the file or directory that you want to copy.
2. Select "Copy" to open the dialog box.

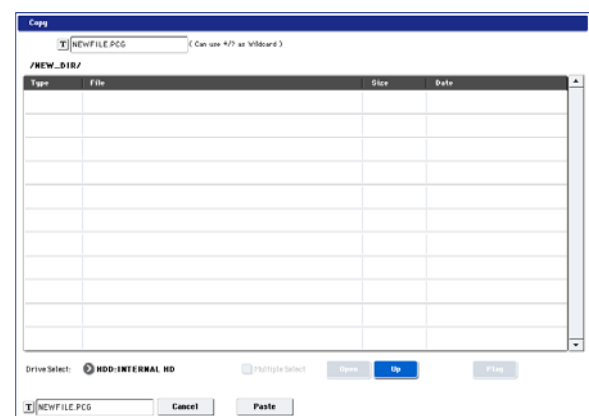

3. "Copy" will show the name of the selected file or directory.

If you wish to change the file or directory that will be copied, use the text edit button to move to the text input dialog box, and specify the filename that you wish to copy.



*Note:* If “Multiple Select” (0–1a) is checked, you can select more than one file and copy them in a single operation.

**4. Use the Open button and Up button to select the copy destination directory.**

If you wish to specify a different USB device, use “Drive Select” (0–1a) to select it.

**5. If you wish to change the name of the newly copied file or directory, use the text edit button (in the lower line) to open the text input dialog box, and enter the new name.**

You can’t change the filenames if you’re using wild cards or **Multiple Select** to copy two or more files simultaneously.

**6. To copy the data, press the OK button. To cancel without copying, press the Cancel button.**

If the drive that you selected in “Drive Select” is a removable disk (floppy disk, CD-R/RW, MO disc, removable hard disk etc.), it is not possible to copy to different media on the same drive.

**Using wildcards**

(Can use \*/? as Wildcard): When you use the text edit button to access the text input dialog box and specify the name of the file or directory to be copied, you can use “\*” and “?” characters as wildcards.

“\*” designates zero or more characters of any kind. For instance, if in the above example you enter PRELOAD1.\* instead of PRELOAD1.PCG, all filenames starting with “PRELOAD1.” will be copied at the same time, regardless of their file extension: i.e., PRELOAD1.PCG, PRELOAD1.SNG, PRELOAD1.KSC, etc.

“?” designates a single character. For instance, if you enter PRELOAD?.PCG, all PCG files whose names start with “PRELOAD” followed by any single character will be copied : i.e., PRELOAD1.PCG, PRELOAD2.PCG, PRELOAD3.PCG, etc.

 When wildcards are used, only files will be copied. Directories will not be copied.

**Delete**

This command deletes the selected file or directory.

This command is valid only if a DOS file or directory is selected.

1. Select the file or directory that you want to delete.
2. Select “Delete” to open the dialog box.

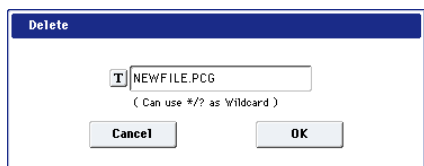

**3. “Delete” will indicate the name of the selected file or directory.**

If you wish to change the file or directory that is to be deleted, use the text edit button to access the text input dialog box, and specify the name of the file or directory that you wish to delete.

**(Can use \*/? as Wildcard):** When you use the text edit button to access the text input dialog box and specify the name of the file to be deleted, you can use the “\*” or “?” characters as wildcards. This allows you to simultaneously delete multiple files with identical filenames and different extensions, or files whose names are partially identical.

 When wildcards are used, only files will be subject to deletion. Directories will not be deleted.

*Note:* If “Multiple Select” (0–1a) is checked, you can select more than one file and delete them in a single operation.

**4. To delete the selected file or directory, press the OK button. To cancel without deleting, press the Cancel button.**

**Delete Unused WAV Files**

This command operates on an .SNG file selected in the file browser. It searches the .SNG’s audio directory for WAV files which are not used in any of the .SNG’s Songs (such as discarded audio takes), and then deletes those files along with any related region data.

This can be useful to free up space on your disk.

If an .SNG file is not selected, the menu command is unavailable.

For more information on .SNG audio directories, see “How audio data is stored on the disk” on page 90 of the Operation Guide.

1. Select the .SNG file for which you want to delete unused sounds.
2. Select the “Delete Unused WAV Files” menu command.

The Delete Unused WAV Files dialog will appear.

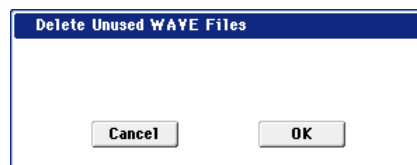

**3. To delete the unused WAV files, press the OK button. To cancel without affecting any files, press the Cancel button.**

 Once you press OK, the deletion is permanent and cannot be undone. Pressing the COMPARE button will have no effect.

**Create Directory**

This command creates a new directory within the current directory.

**1. Select “Create Directory” to open the dialog box.**



2. Use the text edit button to access the text input dialog box, and specify the name of the new directory.
3. To create the directory, press the OK button. To cancel without creating the directory, press the Cancel button.

## Set Date/Time

This command sets the date and time of the KRONOS's internal calendar.

1. Select "Set Date/Time" to open the dialog box.

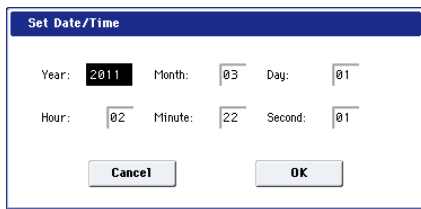

2. Set each parameter.

"Year" 1980–2037  
 "Month" 1–12  
 "Day" 1–31  
 "Hour" 0–23  
 "Minute" 0–59  
 "Second" 0–59

3. To set the date and time, press the OK button. To cancel, press the Cancel button.

## Format

This command formats the selected media. The volume label (a name for the entire media) you specify will be assigned to the media. The volume label you assign here will be displayed in "Drive Select" (0–1a). The volume label can be a maximum of eleven characters.

 When you format, all data saved on that media will be erased. If you had used a computer etc. to set up that drive so that it can be used as multiple drives (partitions), this data will also be erased. Be sure to double-check before you format.

After formatting, it is not possible to press the COMPARE switch to return to the previous state.

1. Make sure that the media you want to format is inserted.
2. Use "Drive Select" to select the media that will be formatted.
3. Select "Format" to open the dialog box.

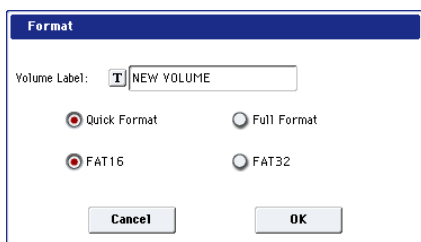

4. In "Volume Label," use the text edit button to access the text input dialog box, and specify the volume label.

The previously-specified volume label will be displayed. If no volume label had been specified for the media, or if a non-DOS media was inserted, this will indicate "NEW VOLUME."

5. Specify the initialization format.

**Quick Format:** Normally you should use Quick Format to initialize the media.

Select this if the media has already been physically formatted, or if you want to format media that has been UDF-formatted by the KRONOS. Since only the system area of the media need be formatted, this will require less time.

**Full Format:** Select this when formatting media that has not been physically formatted, or media (CD-RW) that has not been UDF-formatted.

*Note:* For the internal hard disk you can only select "Quick Format." Also, the file system selection of FAT16 or FAT32 in step 6 is not available.

*Note:* Normally, it is not necessary to perform a Full Format on media that has already been physically formatted. Execute the Quick Format for such media.

*Note:* You will normally select Full Format for CD-RW media etc. that has not been UDF-formatted. If an error message of "Media not formatted" appears, execute Full Format. Depending on the capacity of the media, executing Full Format may require a substantial length of time.

6. Specify the file system.

FAT16 can format a maximum of 4 Gigabytes. If you are using media larger than this., use FAT32 format instead. (FAT32's the theoretical maximum is 2 Terabytes, or 2,000 Gigabytes.)

7. To format the media, press the OK button. To cancel without formatting, press the Cancel button.

*Note:* If you want to use a CD-R/RW for writing packet data, you must format it. If you will be using it as an audio CD, formatting is not necessary.

## Convert to ISO9660 Format

This command converts UDF format CD-R media to ISO9660 format.

If a file that was saved by the KRONOS to CD-R is to be loaded by another device, you must execute this command to convert it to ISO9660 format.

This conversion temporarily uses memory space on the hard disk.

1. Select "Convert to ISO9660 Format" to open the dialog box.

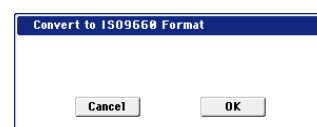

2. Press the OK button to execute the conversion, or press the Cancel button to cancel without executing.

 Even if data is converted into ISO9660 format, some files may not be readable by certain devices.

## Rate Convert

This command converts the sampling rate (frequency) of the selected WAVE file from 48 kHz to 44.1 kHz or 44.1 kHz to 48 kHz.

This is valid only when a 48 kHz or 44.1 kHz WAVE file is selected.

When you use the Make Audio CD page to write a WAVE file to an audio CD, 48 kHz files will automatically be converted to 44.1 kHz.

1. Select the file or directory whose sampling rate (frequency) you want to convert.
2. Select "Rate Convert" to open the dialog box.

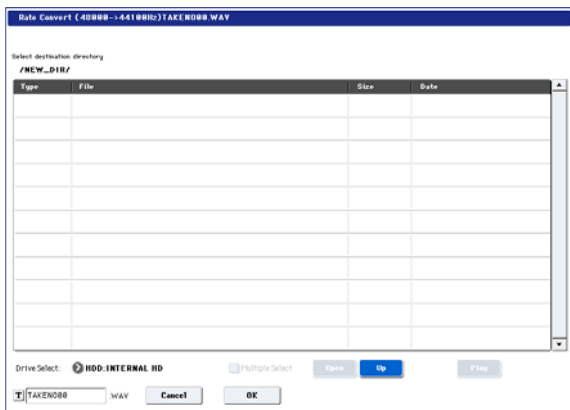

"Rate Convert" will indicate the name of the selected file.

3. Use the Open button and Up button to select the save-destination directory.  
If you want to specify another USB device, use "Drive Select" to specify it.
4. If you want to change the filename for saving, press the text edit button in the lower line to access the text input dialog box, and specify the filename for saving.
5. Press the OK button to execute the Rate Convert command, or press the Cancel button to cancel without executing.

## Check Medium

This command checks the selected storage media for errors, and corrects any errors if possible. Use **Check Medium** if you frequently experience messages such as "Error in writing to medium" while saving files, or "Buffer overrun error occurred" while sampling to disk.

1. Use "Drive Select" to select the media that you want to check.
2. Select "Check Medium" to open the dialog box.

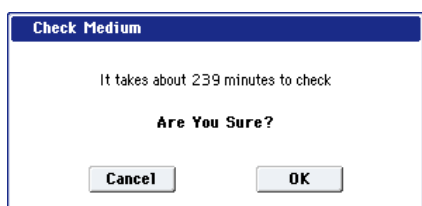

The dialog includes a rough estimate of the time required to complete the process for the selected media. The actual time required will vary depending on the speed and capacity of the media, as well as the number of errors that are found.

3. Press the OK button to start checking the media, or press the Cancel button to cancel.
4. When process has been completed, the recovered content will be displayed.

*Note:* If you want to stop the checking process before it has been completed, press the Abort button.

## Swap Track

This command exchanges (swaps) the order of two audio CD tracks.

1. Select "Swap Track" to open the dialog box.



2. Use "Source1" and "Source2" to select the two audio CD tracks that you want to exchange.
3. Press the OK button to execute the Swap Track operation, or press the Cancel button to cancel without executing.

## Write to CD

When this command is executed, the WAVE files specified in the audio CD track list will be written as audio CD tracks. If desired, you can also finalize the disc at this time.

- ⚠ When writing data to CD-R/RW media, the media containing the Wave files must have free space equal in size to the Wave files you are writing. Before you execute this operation, make sure that the drive containing the Wave files contains enough free space.

1. Create an audio CD track list, use "Drive Select" to select the CD-R/RW drive, and make sure that CD-R/RW media is inserted in the drive.
2. Select "Write to CD" to open the dialog box.

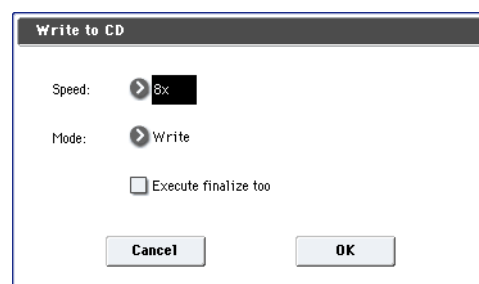

3. Use "Speed" to specify the writing speed. The writing speeds supported by your CD-R/RW drive will be displayed.

- ⚠ Be aware that if your system has a slower data transfer rate, using an excessively fast writing speed will produce writing errors. Depending on the drive

you are using, problems with the speed may make it impossible to write, but you can perform a test beforehand to identify such problems. It is a good idea to perform a test write when you write for the first time, to verify the speed limitations of your drive.

- 4. If the audio CD track list contains WAVE files located on an external USB 1.1 type hard disk, writing errors may occur even if you specify the slowest writing speed. If this occurs, copy the WAVE files to the internal hard disk, and change the audio CD track list so that it uses the copied WAVE file located on the internal hard disk.

Use **Mode** to specify the writing method.

**Test:** Tests whether the data can be written correctly. Data will not actually be written to the CD-R/RW media, but all other processing will occur just as if data were actually being written. Use this when you want to check whether writing can be performed correctly. If an error occurs, the display will indicate "Error in writing to medium."

**Test and Write:** A test write will be performed, and if the test is successful, the disc will actually be written. We recommend that you use this method for fast writing speeds.

**Write:** The media will only be written.

4. Specify whether the CD-R/RW media will be finalized after the audio CD tracks have been written to it.

If "Execute finalize too" is checked, the disc will be finalized.

If this is not checked, the disc will not be finalized.

*Note:* If you want only to finalize the disc, use "Finalize Audio CD."

5. Press the OK button to execute writing or test writing to the CD-R/RW media, or press the Cancel button to cancel without executing.

- 4. WAVE files with a 48 kHz sampling frequency will be converted to 44.1 kHz when they are written.

In order for this processing to be performed, free space of approximately the same size as the WAVE file to be converted will be required on the drive that contains the WAVE file. Before executing, please make sure that the drive containing the WAVE file has enough free space.

*Note:* If the track is shorter than 4 seconds, silence will be automatically added to increase the length to 4 seconds.

*Note:* Two seconds of silence will be added to the end of each track except the last track.

---

## Finalize Audio CD

This command finalizes CD-R/RW media to which audio CD tracks have already been written.

1. Use "Drive Select" to select the drive, and make sure that the drive contains valid media.
2. Select "Finalize Audio CD" to open the dialog box.



3. Press the OK button to execute the Finalize command, or press the Cancel button to cancel without executing.

---

## Erase CD-RW

This command erases the audio CD tracks from CD-RW media.

1. Use "Drive Select" to select the drive, and make sure that it contains data.
2. Select "Erase CD-RW" to open the dialog box.

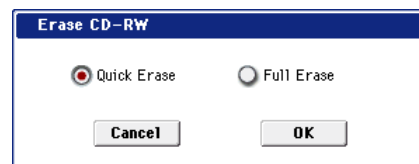

3. Select the mode by which the audio CD tracks will be erased.

**Quick Erase:** Normally you will select this.

**Full Erase:** The data will be erased completely. Substantial time will be required for the erasure.

When you execute Quick Erase, the files and data will appear to be gone, but the data itself will remain on the disc until it is overwritten. If you want to erase data that should not be seen by someone else, execute Full Erase to erase the data completely.

4. Press the OK button to execute the Erase operation, or press the Cancel button to cancel without executing.

---

## Install EXs

This command installs the selected EXs data onto the internal SSD, along with any associated files (.KSC, .PCG, .SNG etc). Note that EXs can only be installed onto the internal SSD, and not to USB storage media.

To install an EXs:

1. If you downloaded the EXs data, un-zip the downloaded file.

Un-zipping the archive will result in a folder containing several different files.

*Note:* Depending on your browser settings, the downloaded file may be unzipped automatically. One of the files in the resulting folder has a name which ends with "tar.gz." Please do not un-zip this tar.gz file.

2. Copy the un-zipped folder to a USB storage device.
3. Safely disconnect the USB storage device from your computer.
4. Connect the USB storage device to the KRONOS.
5. Go to the Disk Utility page.

**6. Using the Drive Select menu at the bottom of the page, select the USB storage device.**

You may need to wait a few seconds after connecting the device before it is recognized.

**7. Open the folder containing the EXs data from step 2.**

**8. Select the file whose name ends in .exsins.**

The “exsins” suffix stands for “EXS INStaller.” For instance, an installer file might be named “EXs10.exsins.”

When a .exsins file is selected, the **Load** button changes to read **Install**. Only one EXs can be installed at a time. If **Multiple Select** is **On**, **Install** will be disabled.

**9. Select Install EXs from the menu, or press the Install button.**

The system will check to confirm that the installation files are valid, and that there is sufficient space on the SSD to install the EXs. Next, a dialog box will appear:



Found installer for: [EXs name]

Space required: [nnn] MB

SSD1: [disk name] [nnn] GB available

**10. Press Install to continue with the installation, or press Cancel to stop without installing.**

An “are you sure?” message will appear to confirm the installation.

**11. Press OK to continue with the installation, or press Cancel to stop without installing.**

The installation will then begin. This may take a while; a progress bar shows the installation as it proceeds. Next, the newly installed files will be verified.

After the verification has completed successfully, the progress bar will disappear, and the installation is complete. The EXs sample data itself is installed on an invisible, protected part of the disk. To use the EXs, you’ll load its associated files (.KSC, .PCG etc.); for the location of these files, see the documentation of the specific EXs.

**Using the newly installed EXs**

To use the new EXs:

**1. Load the newly installed .PCG and .KSC files.**

Make sure to back up any sounds before over-writing them in memory. You may need to free up sample RAM, or use the “Clear” option when loading the .KSC. You can also load specific sounds from the .KSC,

make your own sub-sets of its sounds, and automatically load the new samples at startup. For more information, see:

Global “0–3: KSC Auto-Load” on page 762

Global “0–4: Sample Management” on page 765

Disk mode menu command “Load .PCG” on page 829

Disk mode menu command “Load .KSC” on page 838

**Authorization**

If an authorization code is required, the EXs will work in demo mode, fading in and out, until the code is purchased and entered into the KRONOS. For more information, see “Global P6: Options Info” on page 803.

**Error messages**

When installing, error messages may be displayed to indicate problems, as described below.

“Error: invalid option file” means that the installation data is corrupted. Copy the file to the USB media again, or if that fails, download the data again.

“Error: not enough disk space for the installation” means that the internal SSD is too full. Remove data from the SSD, backing it up to USB media, in order to free up space.

**Uninstalling EXs**

Optional EXs may be uninstalled to reclaim space on the internal disk(s). For more information, see “Uninstall EXs” on page 814.



# Effect Guide

## Overview

The KRONOS provides 12 insert effects, two master effects, and two total effects, together with a mixer section that controls the routing of these effects.

For each of these effect processors, you can choose from 185 different types of effects, grouped into the following categories:

### Effects categories

Dynamics: 000...010	Dynamics-type effects such as compressor and limiter
EQ/Filter: 011...026	Filter-type effects such as EQ, exciter, and wah
OD/Amp/Mic: 027...039	Overdrive effects and modeling effects such as guitar/bass amps and mics

Cho/Fln/Phs: 040...054	Pitch and phase modulation effects such as chorus and flanger
Mod/PShift: 055...076	Other modulation effects such as tremolo and rotary speaker, and pitch shifters
Delay: 077...099	Delays
Reverb/ER: 100...108	Reverb and early reflections
Mono-Mono: 109...140	Mono & Mono chain effects that internally connect two mono effects in series
Mono/Mono: 141...185	Mono & Mono parallel effects that allow two mono effects to be applied to L and R independently

## Effects in each mode

### Program mode

With HD-1 Programs, you can use insert effects to process the final sound in the same way that you use the Filter, Driver, Amplifier, and EQ (equalizer) to process the sound from the oscillators (OSC 1 & 2). Then the master effects are used to create overall ambience such as reverb, and use the total effects to

make final adjustments. All of these settings can be made independently for each program. EXi Programs have a different filter and amp structure for each type, but you can also apply insert effects, master effects, and total effects to the oscillators (EXi1&2), just as for an HD-1 program.

*Program mode: HD-1*

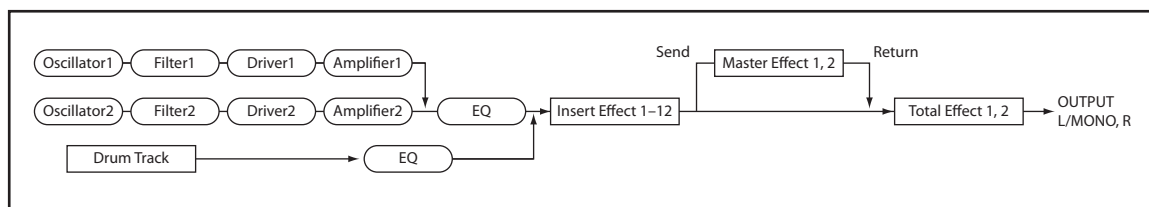

### Combination and Sequencer modes

In Combination and Sequencer modes, you can use the track EQ and insert effects to process the program sound (and audio track sound) of each timbre/track. Then you can use the master effects to create overall ambience, and use the total effects to make final adjustments.

In Combination mode you can make these settings for each combination, and in Sequencer mode you can make them for each song.

In Sequencer mode, you can switch between effects or modify the effect parameters and record these changes, so that effects will switch automatically or effect parameters will be modified automatically as the song plays back.

Combination and Sequencer modes

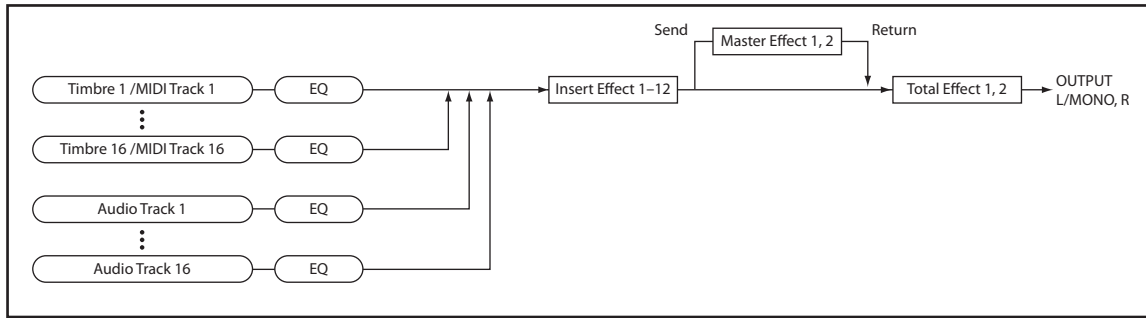

Sampling mode

In Sampling mode, external audio sources from AUDIO INPUT 1-2, USB, and S/P DIF IN jacks or the playback from a USB-connected CD drive can be processed by insert effects, master effects, and total effects, and then sampled. Use the P0: Recording-

Audio Input page to make audio input settings for Sampling mode. These settings apply only to Sampling mode.

Samples that you've assigned as a multisample can also be processed by the insert effects, master effects, and total effects, and then resampled.

Sampling mode

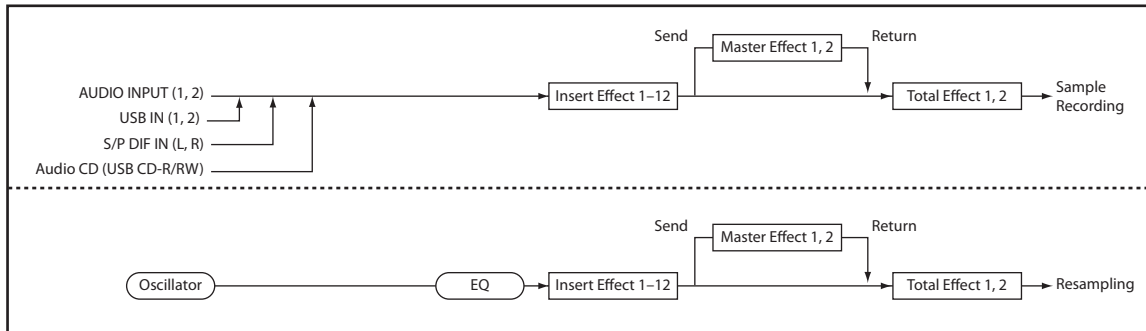

Audio Input

You can also use the external audio inputs in Program, Combination, and Sequencer modes.

You can apply the insert effects, master effects, and total effects to external audio sources and sample them, or use the KRONOS as a 6-in (stereo analog, S/P DIF, and USB) 6-out effect processor. You can also use an external mic input to control a vocoder effect (026: Vocoder) applied to internal sounds.

In Sequencer mode you can also use the effects when recording external audio sources to audio tracks.

⚠ When effects are applied to the audio inputs, certain effect types or parameter settings may cause oscillation to occur. If this occurs, adjust the input level, output level, or effect parameters. Please be aware of this particularly when using an effect that has a high gain.

Use the P0- Audio Input/Sampling page of each mode to make audio input settings. Alternatively, you can check **Use Global Setting** and make these settings in the Global mode P0: Basic Setup- Audio page. Normally you will leave Use Global Setting checked. Uncheck this if you want programs and combinations to use their own settings—for example, when writing a program to use as a vocoder effect.

Audio Input (Program mode)

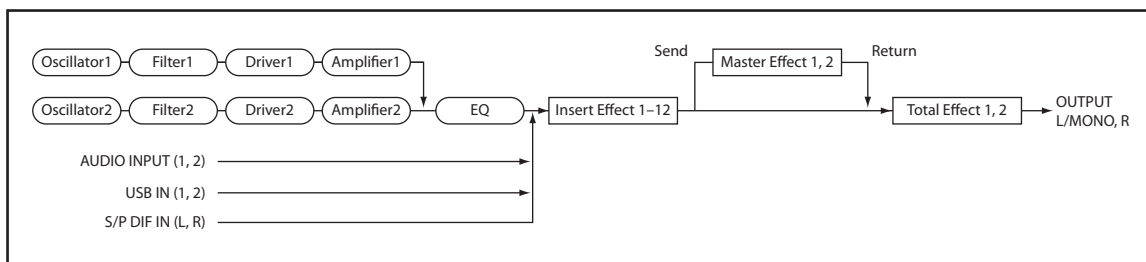



## Dynamic modulation (Dmod) and Tempo Synchronization

### Dynamic modulation (Dmod)

Dynamic modulation lets you control certain effects parameters in real-time, using either the built-in controllers or MIDI. These effect parameters are marked with the logo .

For more information, see “Dynamic Modulation Sources (Dmod)” on page 1101.

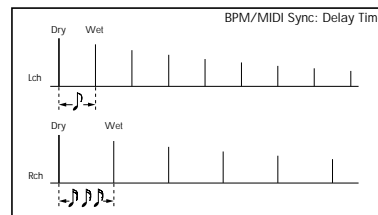

### Tempo Synchronization

You can synchronize some effects parameters, such as LFO speeds and delay times, to the system tempo. This lets you sync the effects to Program LFOs, step sequencers, Wave Sequences, Vector Envelope, KARMA, the internal sequencer, and external MIDI clocks.

These effects parameters are marked with the logo .

#### Synchronizing LFOs

Most effects with LFOs, such as 016: Stereo Wah/Auto Wah, can be synchronized to tempo. This applies to the individual effects LFOs, and also the Common FX LFO.

To set up LFOs to synchronize to tempo:

1. Set MIDI/Tempo Sync to On.
2. Set the BPM as desired.

To synchronize to the system clock, set **BPM** to MIDI.

To set the LFO to a specific tempo, separate from the system clock, set **BPM** to the desired tempo (between 40 and 240 BPM).

3. Use the Base Note and Times (x) parameters to set the rhythmic value of the LFO.

For instance, if you set **Base Note** to 1/8 and **Times (x)** to 2, each cycle of the LFO will last for a quarter-note (two eighth-notes).

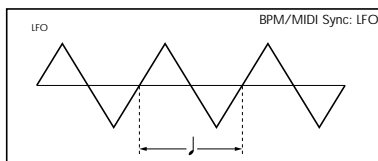

#### Synchronizing Delay Times

Delays with “BPM” in their title will sync to tempo.

For instance, you might set up effect 093: Stereo BPM Delay as follows:

1. Set L Delay Base Note to 1/8, and Times (x) to 1
2. Set R Delay Base Note to 1/16, and Times (x) to 3

This means that the left channel will be delayed by an eighth-note, and the right channel will be delayed by a dotted eighth-note (three sixteenth-notes).

### 3. Set the BPM as desired.

To synchronize to the system clock, set **BPM** to MIDI.

To set the delays to a specific tempo, separate from the system clock, set **BPM** to the desired tempo (between 40 and 240 BPM).

If the combination of the tempo, **Base Note**, and **Times (x)** settings in conjunction would exceed the maximum delay time, a warning such as “Time Over? >OVER!” will appear in the display. If this happens, just reduce the delay time. Note that the maximum delay time depends on which delay effect you’re using. For instance, the maximum delay time for 093: Stereo BPM Delay is 1,360msec, while the maximum delay time for 094: Stereo BPM Long Delay is 2,730msec.

## Common FX LFOs

Normally, LFO-based effects—such as choruses, flangers, phasers, filters, and auto-panners—each have their own independent LFO. The KRONOS effects support this standard mechanism, but add a new one: Common FX LFOs.

The two Common FX LFOs allow you to synchronize multiple LFO-based effects together. They're available in most LFO-based effects, in addition to the individual LFOs, providing:

- Master sources of frequency and phase for all LFO-based effects
- LFO speed set by either frequency or tempo
- Reset from Dmod sources, for either realtime performance or synchronizing to a down-beat in a sequence

When using the Common FX LFOs, you can still control the LFO phase individually for each effect, and often change the waveform individually as well.

You can edit the Common FX LFO parameters on the P8– Common FX LFO pages of Program, Combination, Sequencer, and Sampling modes.

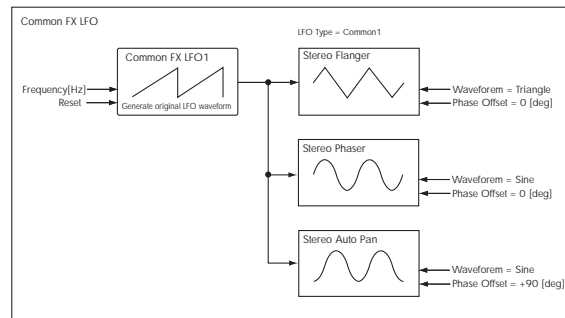

## FX Control Buses

The FX Control Buses lets you create effects “sidechains.” Sidechains let you control an effect with one audio signal (the sidechain), while the effect processes a completely different audio signal. This is convenient for use with vocoders, compressors and limiters, gates, etc.

KRONOS includes two stereo FX Control Buses, which can be used with the following effects:

### Vocoder

- 026: Vocoder

### Compressor, limiter, and gate effects

- 002: Stereo Compressor
- 003: Stereo Expander
- 005: Stereo Limiter
- 009: Stereo Gate
- 010: Stereo Noise Reduction

## Gated Reverb (Program mode)

The classic gated reverb sound is created using a sidechain:

- Dry audio goes through a reverb effect
- The output of the reverb goes to a gate effect
- The opening and closing of the gate is controlled by the original dry audio, through a sidechain

To create this on the KRONOS, in Program mode:

1. On the IFX Routing page, set Bus Select to IFX1.
2. Set FX Control Bus to FX Control 1.
3. On the IFX Insert Effects page, set IFX1 to 101: Reverb Hall.
4. Set IFX2 to 009: Stereo Gate.
5. Enable Chain for IFX1, and set Chain To to IFX2.
6. In the Stereo Gate effect, set the Envelope Source to FX Control 1.

Now, the gate will affect the output of the reverb, but the gate will be controlled by the pre-reverb dry signal.

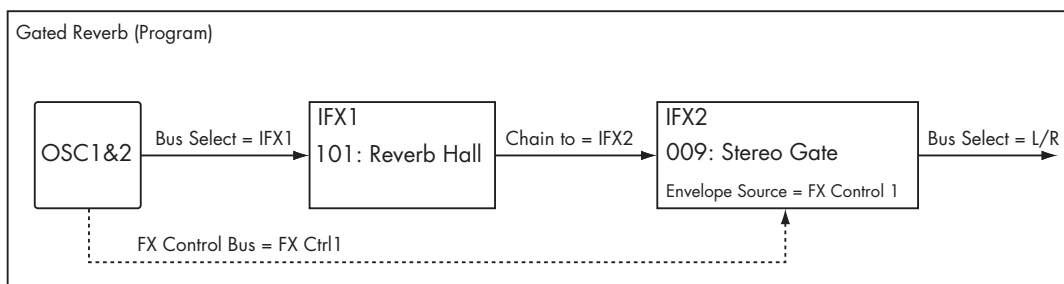

### Compressor (Combination mode)

Compressors, limiters, and gates use the level of the audio input to control the level of the audio output. For these effects, the envelope detection source can be either the audio input itself (the usual method) or FX Control Bus 1 or 2.

The diagram below shows a split Combination, with a pad on the bottom of the keyboard and a distorted guitar on the top. The output of the OD/High-Gain Wah effect controls the action of the pad's compressor, so that when the guitar is played, the level of the pad decreases automatically. To do this:

1. Set up the Timbres and effects as shown in the diagram below.

2. Set IFX2's Ctrl Bus to FX Ctrl1.

This sends the output of IFX2 to FX Control Bus 1.

3. In IFX1: Stereo Compressor, set the Envelope Source to FX Ctrl1.

Now, the compressor will still process the input from the pad, but the amount of compression will be controlled by the guitar (through IFX2).

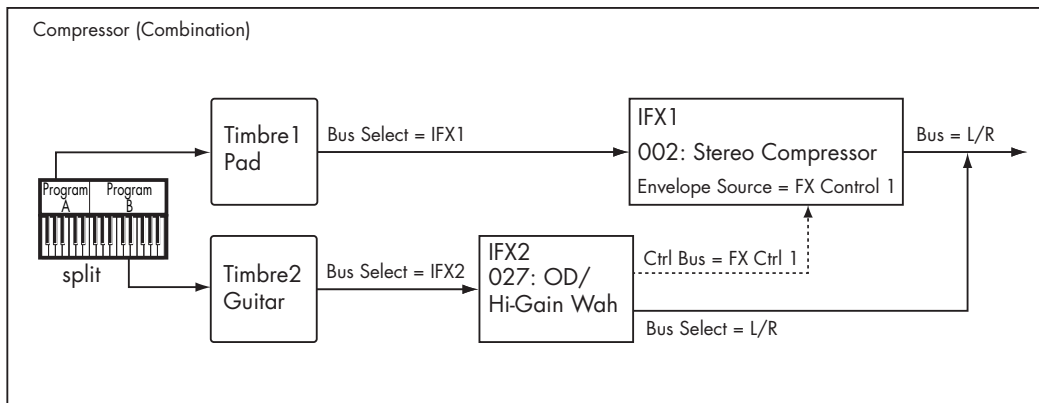

### Vocoder (Program mode)

Vocoder effects produce their distinctive sound by using an audio signal (the modulator) to modulate a different audio signal (the carrier). In the diagram, the combined output of OSC1 and 2 is the carrier, and the audio input from a mic is used as the modulator to produce a “speaking instrument” type of effect. To do this:

This sends the output of the Program to the Vocoder.

2. For the Audio Input, set the FX Control Bus (0–8c) to FX Control 1.

This sends the audio input to FX Control Bus 1.

3. In IFX1: Vocoder, set the Modulator Source to FX Control 1.

Now, through FX Control Bus 1, the audio input is the modulator for the vocoder.

1. In the Program, set Bus Select to IFX1.

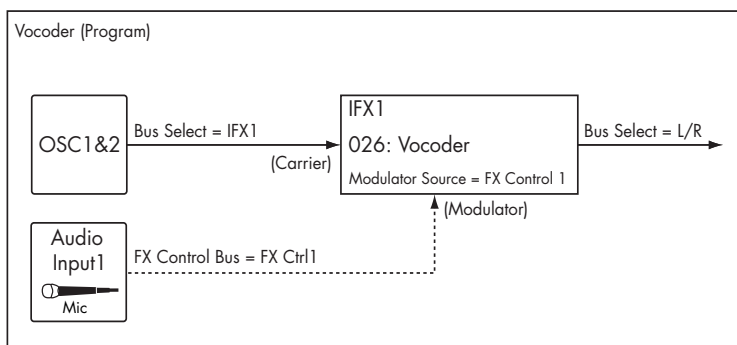

## Rhythmic Vocoder (Combination mode)

Vocoder effects produce their distinctive sound by using an audio signal (the modulator) to modulate a different audio signal (the carrier). Although the most common application of a vocoder is to use audio from a mic as the modulator, you can also use a drum pattern or similar signal as the modulator, producing a rhythmic effect.

In the example shown in the diagram, a drum pattern generated by KARMA is sent to an FX Control bus and used as the modulator for the vocoder. To do this:

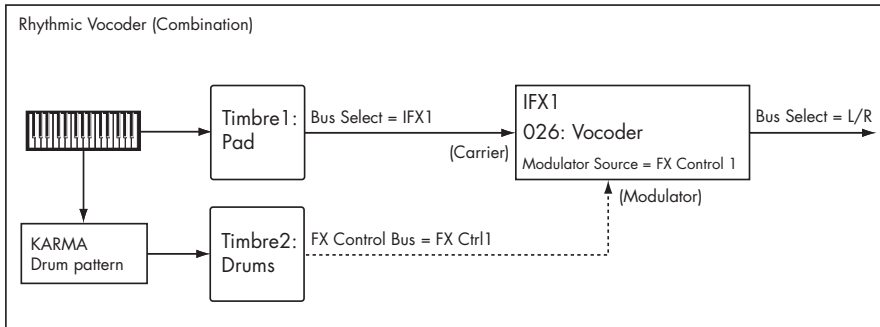

1. For **Timbre 1 (the carrier)**, set **Bus Select** to **IFX1**. This sends the signal to the Vocoder, as the carrier.
2. For **Timbre 2 (the drum program we're using as the modulator)**, set **FX Control Bus** to **FX Ctrl1**.

This sends the signal from Timbre 2 to FX Control Bus 1.

3. In **IFX1: Vocoder**, set the **Modulator Source** to **FX Control 1**.

Now, through FX Control Bus 1, Timbre 2 is the modulator for the vocoder.

## Parallel Effects routing

You can create parallel effects paths using the FX Control Buses. You'll need to use one IFX slot to do so, however.

1. **Route the signal (program, IFX output, etc.) to an output or IFX bus as normal.**
2. **In addition to the normal bus, assign it to one of the FX Control Buses.**
3. **Place an effect which uses the FX Control Buses - the Stereo Compressor, for instance - on any IFX.**

4. In the **Stereo Compressor**, set the **Envelope Source** to the **FX Control Bus** from step 2.

5. **Also in the Stereo Compressor, enable the checkbox labeled Side Chain Monitor.**

Enabling **Side Chain Monitor** means that, instead of hearing the output of the compressor, you'll hear the FX Control Bus input. You can save the effect in this state.

At this point, the compressor is simply serving as a way to access the FX Control Bus, and you can use it to start the parallel branch of the effects chain.

## Effect I/O

To achieve the best tonal quality, signals sent to the effects should be at the maximum level below clipping. Also, use the **Wet/Dry** parameter for the Insert Effects, Total Effects and the **Output Level** or **Return 1/2** parameters for the Master Effects to adjust the effect output level.

- ⚠ If the input level is too low, the SN ratio may decrease. On the other hand, if the input level is too high, clipping may occur. The Global **Internal Headroom** setting will also change the maximum input level of the effect.

The following tables show the parameters related to volume level:

*Program mode (HD-1)*

OSC1/2 MS1...8 Level (P2)
Filter1/2 Input Trim (P3)
Filter1/2 Output Level (P3)
Driver1/2 Drive (P4)
Amp1/2 Amp Level (P4)
EQ Input Trim (P4)

Send1/2 (P8)
Effect Trim parameter *1 (P8, P9)
Effect Wet/Dry parameter (P8, P9)
Return1, 2 (P9)
Master Volume (P9)

*Program mode (EXi: Common)*

EQ Input Trim (P6)
Send1/2 (P8)
Effect Trim parameter *1 (P8, P9)
Effect Wet/Dry parameter (P8, P9)
Return1, 2 (P9)
Master Volume (P9)

*Program mode (AL-1)*

OSC Mixer Level (OSC1, OSC2, Sub OSC, Ring Mod., Noise) (P4)
Filter1/2 Input Trim (P3)
Filter1/2 Output Level (P3)
Driver1/2 Drive (P4)
Amp1/2 Amp Level (P4)

*Program mode (CX-3)*

Expression Minimum, Level (P4)
Drawbar (P5)
Output Level (P7)

*Program mode (STR-1)*

Mixer Level (P4)
Filter Input Trim, Level (P5)
Amp Level (P6)

*Program mode (MS-20EX)*

VCO Mixer, Level(P4)
Mixer1, 2(P5)
Volume(P6)

*Program mode (PolysixEX)*

Output Volume(P4)
-------------------

*Program mode (MOD-7)*

Level (P4)
Output Level (P5)
Filter Output Level (P6)
Mixer Level (P7)
Amp Level (P7)

*Program mode (SGX-1)*

Volume (P4)
Components (P4)

*Program mode (EP-1)*

Harmonic/Attack Noise/Release Noise Level (P4)
Output Level (P4)
Volume (P5)
Cabinet On/Off, Drive (P5)

*Combination and Sequencer modes*

Volume (P0)
Timbre EQ Input Trim (P1)
Send1/2 (P8)
Effect Trim parameter *1 (P8, P9)
Effect Wet/Dry parameter (P8, P9)
Return1, 2 (P9)

*Sampling mode*

AUDIO INPUT LEVEL on the rear panel
Audio Input Level (P0, P5)
Effect Trim parameter *1 (P8, P9)
Send1/2 (P0, P5, P8)
Effect Wet/Dry parameter (P8, P9)
Return1, 2 (P9)

*Audio Input \*2*

AUDIO INPUT LEVEL on the rear panel
Level (P0)
Send1/2 (P0)

\*1 Some effects may not have these parameters.

\*2 These settings are made separately for Programs, Combinations, and Songs. If "Use Global Setting" is checked, these settings are made in Global mode P0.

## Insert Effects (IFX1...IFX12)

### In/Out

Insert Effects (IFX 1–12) have a stereo input and a stereo output. If you set the **Wet/Dry** parameter (P8–IFX1–12 page) to Dry (no effect), the input signal will be passed through, in stereo, without being processed by the effect. If you select Wet (effect applied), the processed signal will be output in one of the following ways:

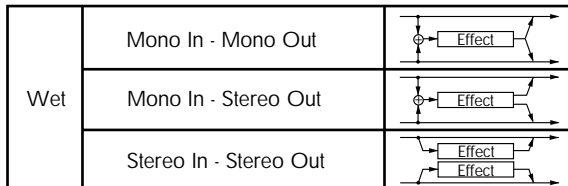

### Mono–Mono Parallel Effects

141: P4EQ // P4EQ - 185: Mt.BPM Dly // Mt.BPM Dly

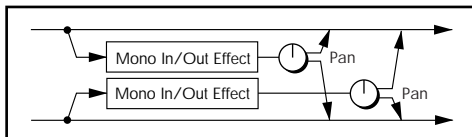

These effects are typically stereo-in/stereo-out, but they have a special structure. The L channel and R channel of the stereo input each have their own independent mono effect. Each mono output can then be panned to the desired position in the stereo field.

- Track1: Piano, **Pan**=L001, **Bus Select**=IFX1
- Track2: E.Piano, **Pan**=R127, **Bus Select**=IFX1

So that you don't mix the sound of the two tracks that are being input, set the P0: Play/REC **Pan** parameter to L001 and R127 respectively.

### Example: IFX1: 148: P4EQ // Phaser

Track 1: Piano is sent to the L channel P4EQ, and Track 2: E.Piano is sent to the R channel Phaser. Use the P8 - IFX page **Pan** parameter to set the output position of each sound. In this example, both are set to C064. See the diagram below.

If you select **000: No Effect**, stereo input signals are output in stereo without being processed.

Pressing the ON/OFF button of IFX1–IFX12 in the P8: Insert FX pages in each mode will toggle between ON and OFF. When OFF is selected, the effect will be bypassed, and the stereo input signal will be output in stereo without being processed.

**MIDI** The KRONOS can also turn IFX1–IFX12 off separately from the setting of the ON/OFF button by receiving MIDI control change message CC#92. Value 0 will turn them off, and value 1–127 will turn them on.

You can also use "Effect Global SW" to turn IFX1–12 on and off. This MIDI control is performed on the global **MIDI channel**.

IFX1: 148: P4EQ // Phaser

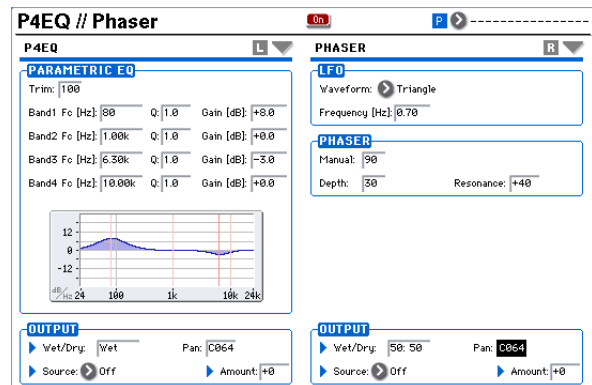

## Routing

You can use up to twelve channels (IFX 1...12) for the Insert Effects in any mode.

### Program mode

Use **Bus Select** (Program 8–1c) to set the destination bus of the oscillator output.

**L/R:** Send the output to the L/R bus. Instead, it is sent to AUDIO OUTPUT (MAIN) L/MONO and R after the TFX1 and 2.

**IFX1...12:** The signal is sent to Insert Effects IFX 1–12.

**1...4, 1/2...3/4:** The signal is sent to the selected Individual Output. For more information, please see “Individual Outputs” on page 885.

**Off:** The output will not be sent to the L/R bus, IFX1–12 buses, or Individual 1–4 buses. Choose the Off setting if you want to connect the oscillator output to a master effect in series. Use **Send1 (to MFX1)** and **Send2 (to MFX2)** to adjust the send level.

Use **Send1 (to MFX1)** and **Send2 (to MFX2)** (Program 8–1f) to specify the send level for the Master Effects. This setting is effective if **Bus Select** (Program 8–1c) is set to L/R or Off.

If **Bus Select** is set to IFX1–12, use **Send1** and **Send2** (Program 8–5a) to specify the send level of the post-IFX signal.

**MIDI** Send1 responds to CC#93, and Send2 responds to CC#91. At this time, the actual send level uses the value of the Send 1 and 2 settings for Oscillators 1 and 2, multiplied by the Send 1 and 2 values received via MIDI.

In the example shown in the diagram (Fig. 2–1a), Oscillators 1 and 2 outputs being sent to IFX1.

If you are connecting the Insert Effects in series, check the **Chain** box (Program 8–5a). Use **Chain to** (Program 8–5a) to specify the destination to which the signal will be chained.

If you check the IFX1 checkbox, the output of IFX1 will be sent to the input of the IFX you specify in “Chain to.” Effects can be chained only in ascending order of their number; for example IFX1 can be chained to IFX2 through IFX12, and IFX2 can be chained to IFX3 through IFX12. You can create a chain of up to twelve insert effects in series, IFX1 through IFX12.

When the Insert Effects are connected in series, the values of the **Pan (CC#8)**, **Bus Sel.**, **REC Bus**, **Send1**, and **Send2** parameters for the post-IFX signal will be used.

In the example shown in the diagram (Fig. 2–1b), the **Chain** check box is checked, and each **Chain to** parameter is set to the subsequent effect, creating a series connection of IFX1 → IFX2 → IFX3 → IFX4 → IFX5 → IFX6 → IFX7 → IFX8 → IFX9 → IFX10 → IFX11 → IFX12. The post-IFX12 settings for **Pan (CC#8)**, **Bus Select**, **REC Bus**, **Send1**, and **Send2** will be used.

### Settings for drum programs

If you have selected “Drums” for **Oscillator Mode** (Program 1–1b) of a Program, the “Use DKit Setting” box (Program 8–1b) becomes available. For more information, please see diagram Fig. 2–1c.

If you check this box, **Bus Select FX Control Bus**, **Send1**, and **Send2** (Global 5–3b) for each key of the selected DrumKit becomes effective. For example, you can send a snare sound to IFX1 to apply the Gate effect, a kick sound to IFX2 to apply EQ, and other sounds to AUDIO OUTPUT (MAIN) L/MONO and R without applying any Insert Effects.

Fig. 2–1a

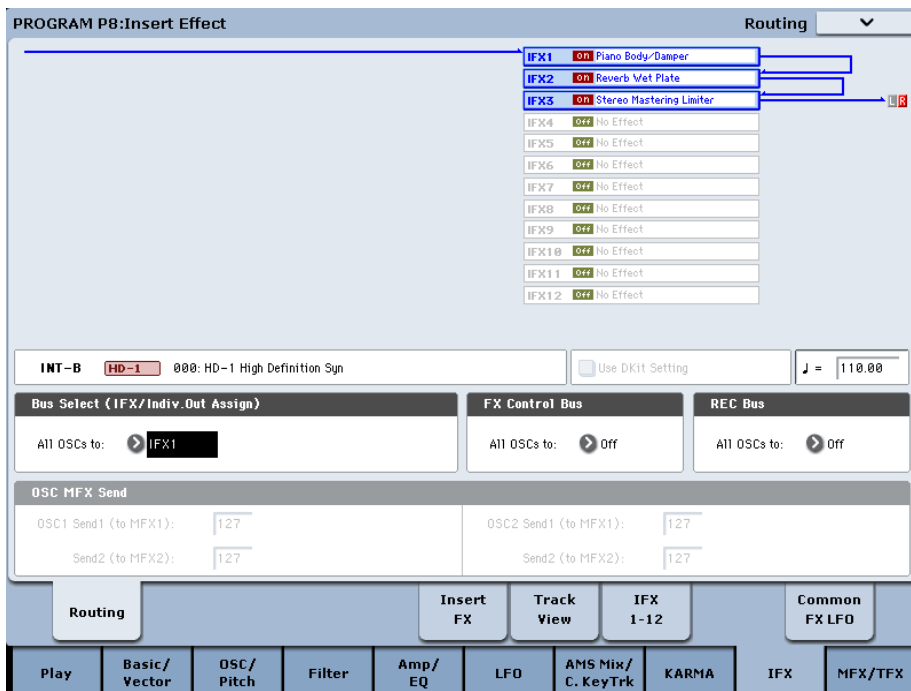



*Tip:* In most of the preloaded drum kits, the following types of drum instrument have the same **Bus Select** settings.

- Snares → IFX1
- Kicks → IFX2
- Toms → IFX3
- Cymbals → IFX4
- Percussion etc. → IFX5

If you de-select the box, all drum instrument outputs are sent to the bus specified by **Bus Select** (Program 8–1c). You may apply any Insert Effects to all drum instruments, regardless of the DrumKit settings.

Fig. 2–1b

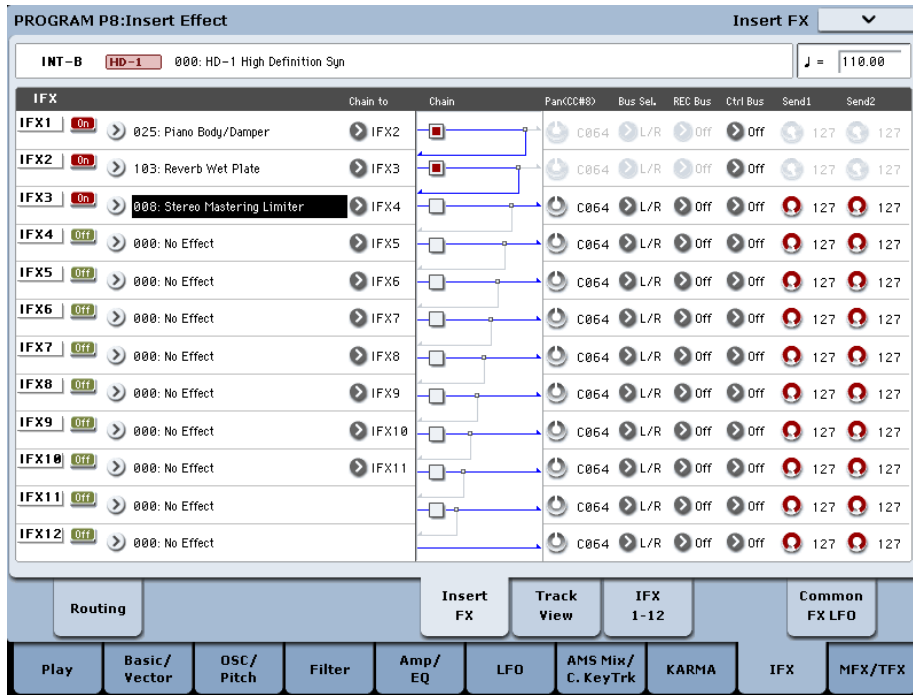
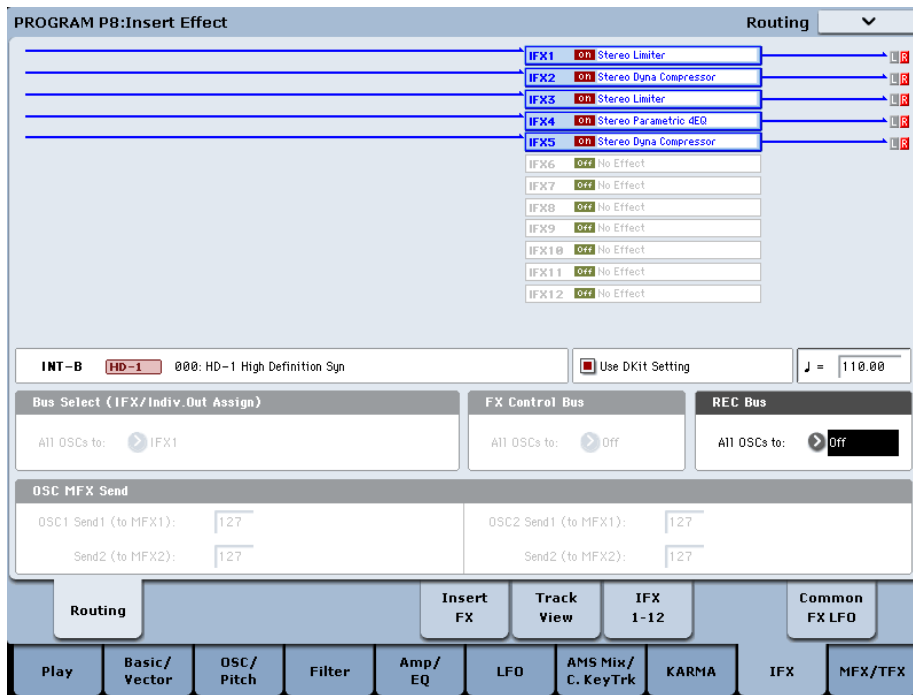

Fig. 2–1c



### Combination and Sequencer modes

Use **Bus Select** (P8: "Routing" 1 and 2 page in each mode) for timbres (Combination) and tracks (Sequencer) to select an Insert Effect to apply to the corresponding timbres and tracks. You can route multiple timbres and tracks to a single Insert Effect.

*Tip:* You can use each timbre/track's **Bus Select**, post-IFX **Chain to** and **Chain** parameters (P8 - Insert FX page of each mode) to create a variety of routings.

*Example: Inserting one IFX into two or more timbres*

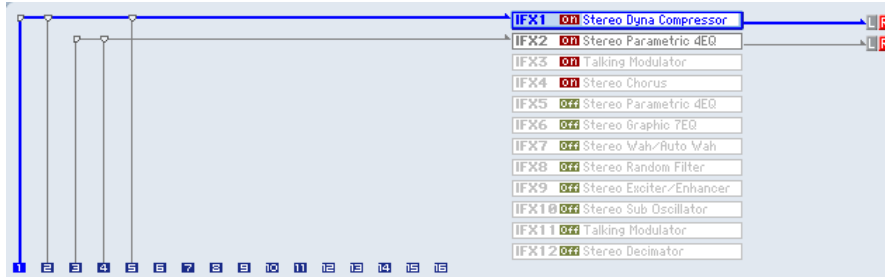

*Example: Inserting a separate IFX into each timbre, and inserting another IFX later*

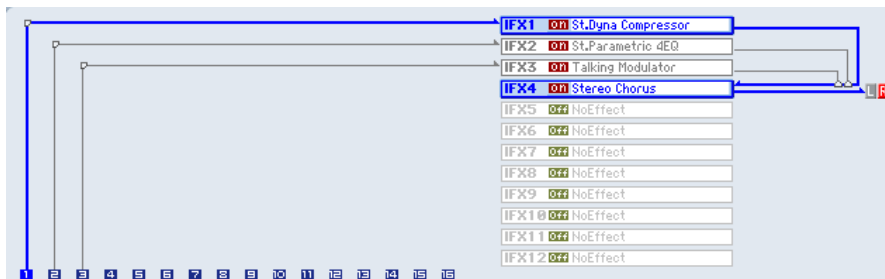

*Example: Sharing part of a timbre's IFX chain with another timbre*

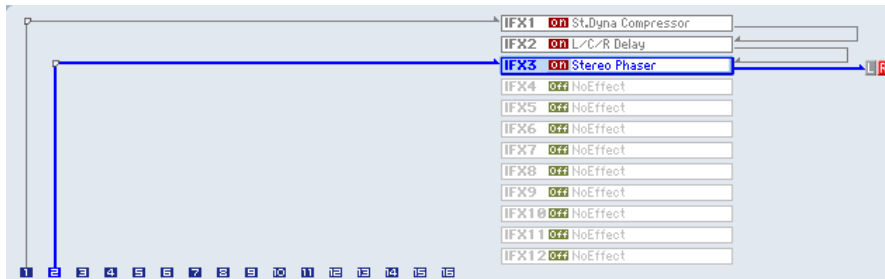

As with Program mode, select L/R, IFX1–12, 1–4, 1/2–3/4, or Off for each timbre and track.

**Send1 (to MFX1)** and **Send2 (to MFX2)** become available if **Bus Select** has been set to L/R or Off. If you've set **Bus Select** to IFX1–12, use **Send1** and **Send2** (P8-Insert FX page) following the insert effect to adjust the send levels.

**MIDI** Send1 responds to CC#93, and Send2 responds to CC#91. At this time, the actual send level uses the value of the Send 1 and 2 settings for Oscillators 1 and 2 of the Programs (selected for the timbres and tracks), multiplied by the Send 1 and 2 values received via MIDI.

The following diagram (Fig. 2–2a) shows an example of Combination mode. The Timbre 1 output is sent to IFX1 and the Timbre 2 output is sent to IFX2 according

to the **Bus Select** setting. Other timbres are sent to L/R. The output signal passes through the TFX1 and 2, then goes to AUDIO OUTPUT (MAIN) L/MONO and R.

Fig. 2–2a

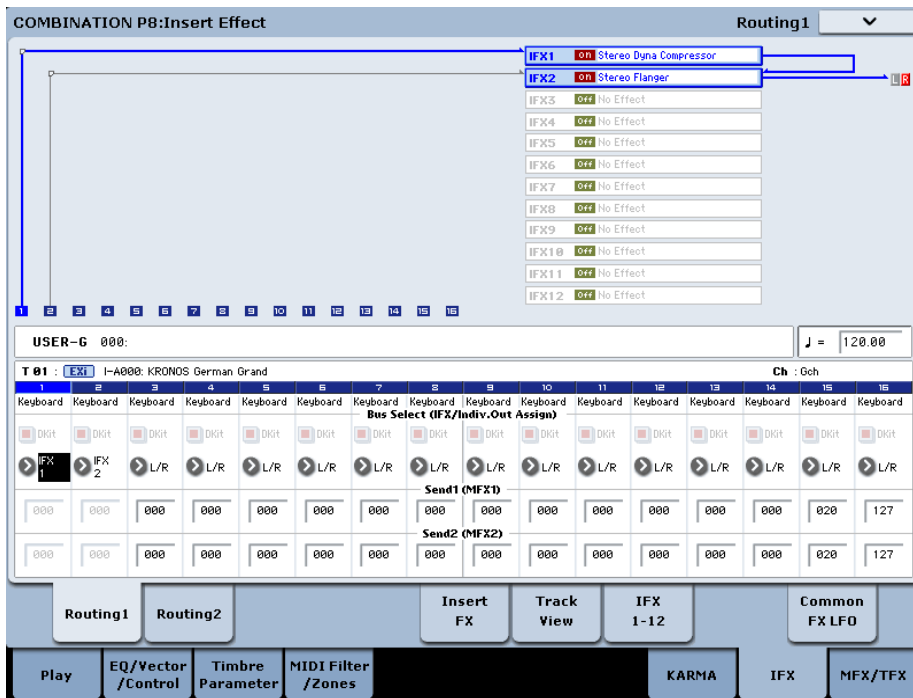

In the diagram (Fig. 2–2b), IFX1's **Chain** check box is checked and **Chain to** set to IFX2, sending the output of IFX1 to IFX2. Timbre 1 is being processed by IFX1: 001: Stereo Dyna Compressor and IFX2: 048: Stereo

Flanger effects. Timbre 2 is being processed by the IFX2: 048: Stereo Flanger effect. The Routing Map area of the diagram (Fig. 2–1a) shows these settings. (With these settings, IFX3–12 are not being used.)

Fig. 2–2b

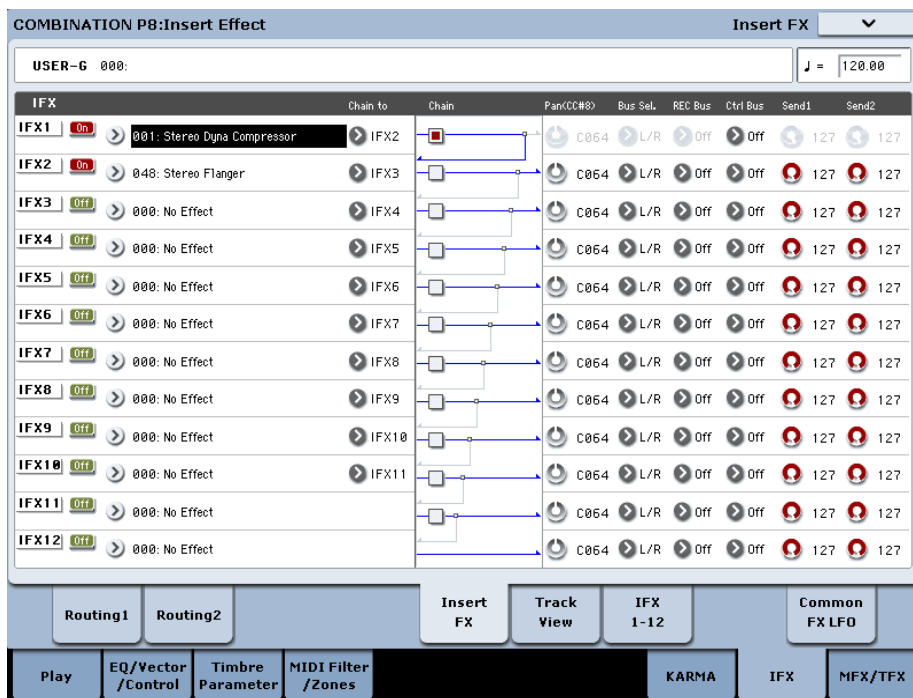

### Drum Programs in Combination and Sequencer modes

If a drum program (**Oscillator Mode = Drums**) is selected for a timbre (Combination) or track (Sequencer), the DKit check box is available (Fig. 2–2c).

**Checking** this check box will enable the **Bus Select** settings etc. of each key in the drum kit, letting you specify the bus to which each drum instrument will be sent. For example you can send snare sounds to IFX1, kick sounds to IFX2, and other drum sounds to L/MONO and R.

If this check box is **unchecked**, all drum instruments will be output according to the **Bus Select** setting of each timbre/track (the P8 - Routing page of each mode). This lets you apply an insert effect to all of the drum instruments in that drum kit.

#### Drum Kit IFX Patch

If “Bus Select DKit” is checked, you can select the **Drum Kit IFX Patch** page menu command by selecting a timbre parameter or by pressing Timbre Number (the blue area in the display for each timbre).

This option allows you to change the routing of the Insert Effects temporarily by changing **Bus Select** for each key.

For example, assume that the DrumKit key assignment is set so that a snare sound is routed to IFX1 and a kick sound is routed to IFX2 etc., IFX1–5. In this case, if you wish to assign IFX 1 and 2 to the Programs used by other timbres and tracks, you can view the routing so that these DrumKit sounds are routed to IFX3 and IFX7 respectively.

Patching is possible only if the **Bus Select** (Global 5–3b) setting of each key in the drum kit is assigned to an insert effect. The state of these settings is also shown in

the Routing Map. Make the desired settings for “DrumKit IFX Patch,” and press the OK button to execute.

If you want to revert to the original settings of the drum kit, execute **Drum Kit IFX Patch** with the settings IFX1 → IFX1, IFX2 → IFX2, IFX3 → IFX3, IFX4 → IFX4, IFX5 → IFX5, IFX6 → IFX6, IFX7 → IFX7, IFX8 → IFX8, IFX9 → IFX9, IFX10 → IFX10, IFX11 → IFX11, and IFX12 → IFX12. You can also revert to the original settings by pressing the RESET button.

In diagram (Fig. 2–2c) below, Drum Program is assigned to Timbre 1, and normal Programs are assigned to Timbres 2 and 3. **Bus Select** is set to DKit for Timbre 1, IFX1 for Timbre 2, and IFX2 for Timbre 3. With Timbre 1, the **Bus Select** (Global 5–2b) for DrumKit setting becomes effective.

Fig. 2–2d: DrumKit IFX Patch dialog

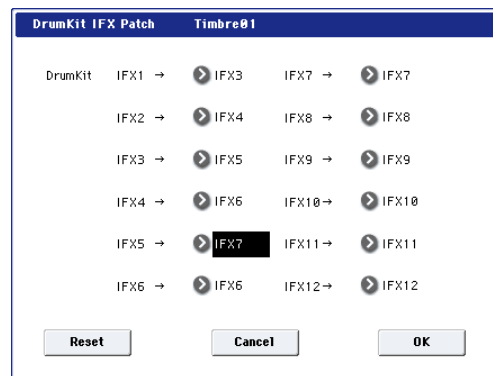

Use the **Drum Kit IFX Patch** page menu command if you want the drum program to use effects other than timbres 2 and 3. Choose **Drum Kit IFX Patch** from the page menu, and temporarily send the drum kit IFX1 to IFX3, IFX2 to IFX4, IFX3 to IFX5, IFX4 to IFX6, and IFX5 to IFX7 (Fig. 2–2d). Executing with these settings will temporarily change the effects to which the drum kit is being sent (Fig. 2–2e).

Fig. 2–2c

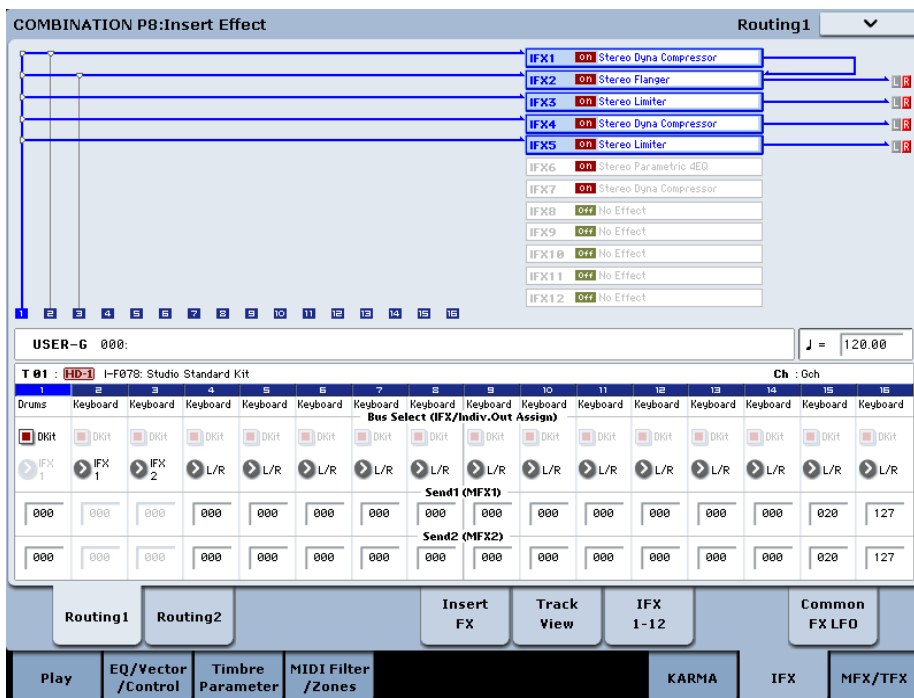

Fig. 2-2e

COMBINATION P8:Insert Effect Routing1

IFX1  Stereo Dyna Compressor  
 IFX2  Stereo Flanger  
 IFX3  Stereo Limiter  
 IFX4  Stereo Dyna Compressor  
 IFX5  Stereo Limiter  
 IFX6  Stereo Parametric 4EQ  
 IFX7  Stereo Dyna Compressor  
 IFX8  No Effect  
 IFX9  No Effect  
 IFX10  No Effect  
 IFX11  No Effect  
 IFX12  No Effect

USER-G 000: J = 120.00

T 01 : HD-1 I-F078: Studio Standard Kit Ch : Gch

1	2	3	4	5	6	7	8	9	10	11	12	13	14	15	16
Drums	Keyboard	Keyboard	Keyboard	Keyboard	Keyboard	Keyboard	Keyboard	Keyboard	Keyboard	Keyboard	Keyboard	Keyboard	Keyboard	Keyboard	Keyboard
DKit	DKit	DKit	DKit	DKit	DKit	DKit	DKit	DKit	DKit	DKit	DKit	DKit	DKit	DKit	DKit
IFX 1	IFX 1	IFX 2	L/R	L/R	L/R	L/R	L/R	L/R	L/R	L/R	L/R	L/R	L/R	L/R	L/R
000	000	000	000	000	000	000	000	000	000	000	000	000	000	020	127
000	000	000	000	000	000	000	000	000	000	000	000	000	000	020	127

Routing1 Routing2 Insert FX Track View IFX 1-12 Common FX LFO

Play EQ/Vector/Control Timbre Parameter MIDI Filter/Zones KARMA IFX MFX/TFX

### Sampling mode

The analog, S/P DIF, and USB audio inputs can be processed by the insert effects, master effects, or total effects then sampled. You can also apply insert effects to the samples assigned to a multisample, and resample the result.

The **Bus Select** settings in the P0– Audio Input page specify the buses to which the external inputs will be sent. You can choose from L/R, IFX1–12, 1–4, 1/2–3/4, or Off. If you want to apply an insert effect while sampling, choose IFX1–12.

Using either the internal CD-R/W drive, or a USB CD drive, you can also sample from an audio CD while applying insert , master , or total effects. Use the CD-R/W Drive Audio Input (5–1b) setting in the P5: Audio CD-Ripping page to set up the effects busing.

In the example shown in the diagram (Fig. 2–3a), the signal from AUDIO INPUT 1 and 2 is being sent to IFX1. Use the P8: Insert Effect page to select an insert effect, and edit its parameters.

The following diagram (Fig. 2–3b) shows an example of bus settings in which the samples assigned to a multisample are resampled with IFX1 applied. Set **Bus Select** (Sampling 8–1b) to IFX1.

⚠ When sampling ends, L/R will automatically be selected as the **Bus Select** setting. Please be aware of this if you continue sampling.

For more details on any of these sampling methods, please see “Sampling (Open Sampling System)” on page 123 of the Operation Guide.

Fig. 2–3a

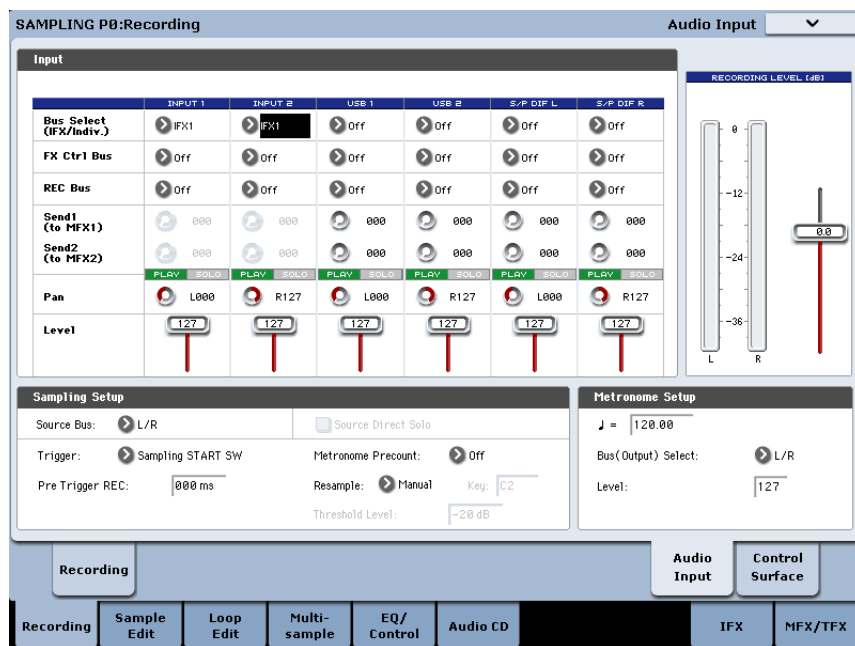
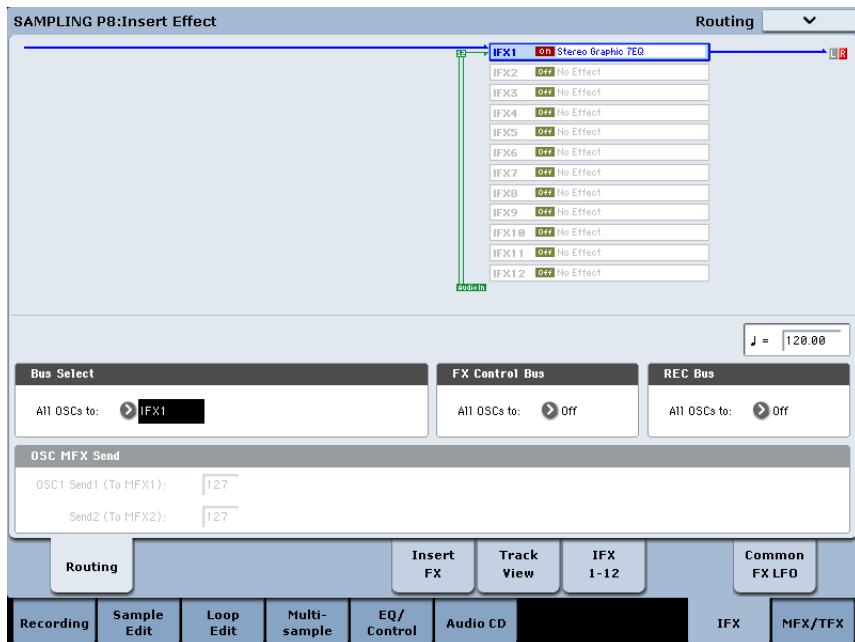

Fig. 2–3b



## Analog, USB, and S/P DIF inputs

In Program, Combination, Sequencer, and Disk modes, external audio sources from the analog, S/P DIF, and USB inputs can be processed by insert effects, master effects, and total effects just as they can in Sampling mode.

You can sample while applying the KRONOS's effects to the external audio sources from these jacks, or use the KRONOS as a 6-in (analog, S/P DIF, and USB) 6-out effect processor. You can also use an external mic input to control a vocoder effect (026: Vocoder) applied to internal sounds.

In Sequencer mode you can also use the effects when recording external audio sources to audio tracks.

In each mode, use "Audio Input" (P0- Audio Input/Sampling page) to make settings for the audio inputs. Alternatively, you can check **Use Global Settings** and use the Global mode "Audio" settings.

Set **Bus Select** to specify the bus to which the external audio input will be sent. You can select L/R, IFX1-12, 1-4, 1/2-3/4, or Off. If you want to apply an insert effect, select IFX1-12.

**Send1 (to MFX1)** and **Send2 (to MFX2)** become effective only when **Bus Select** is set to L/R or Off. If IFX1-12 is selected, use P8: Insert Effect page **Send1** and **Send2** for the post-IFX signal.

The diagram (Fig. 2-4a) shows an example in which the input from INPUT 1 and 2 is panned to left and right, and sent to insert effect 1.

 In Disk mode, effects will use the settings of the mode in which you previously were.

Fig. 2-4a



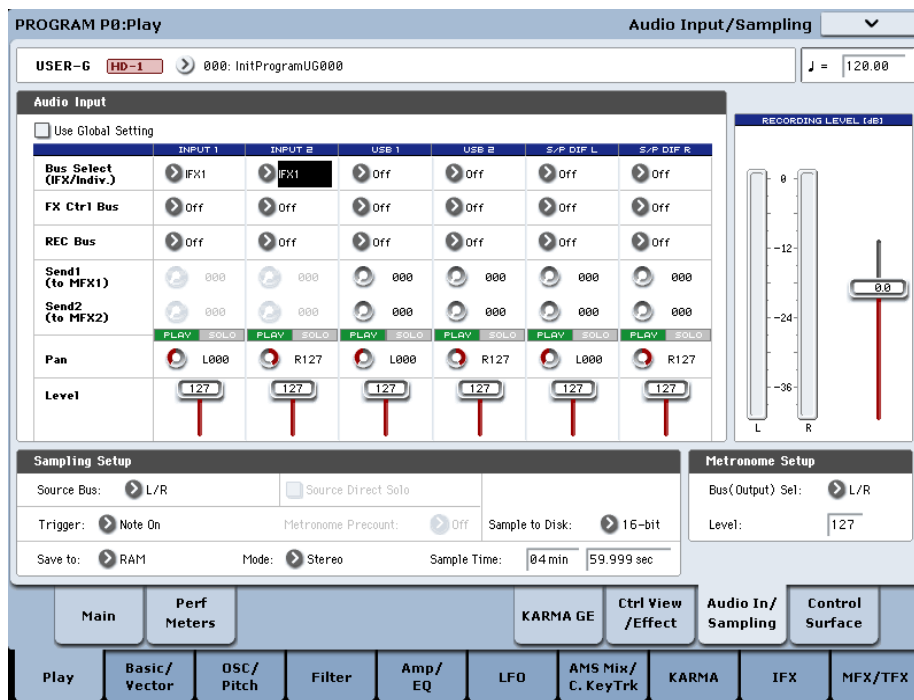

## Audio CD

In Sampling mode, the sound from an audio CD in a USB external CD drive can be processed by the insert effects, master effects, and total effects.

Use the **Bus Select** setting in the P5: Audio CD - Ripping page to specify the bus to which the CD audio will be sent. You can choose from L/R, IFX1-12, 1-4, 1/2-3/4, or Off. If you want to apply an insert effect, choose IFX1-12.

Fig. 2-5a

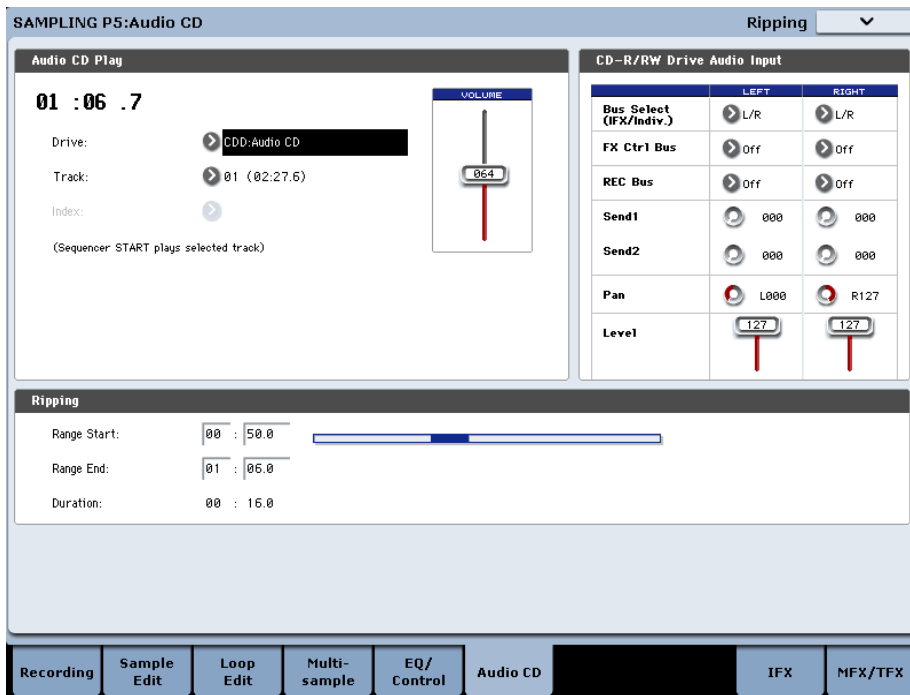

The **Send1 (to MFX1)** and **Send2 (to MFX2)** settings which specify the send levels to the master effects are valid if **Bus Select** is set to L/R or Off. If **Bus Select** is set to IFX1-12, use the post-IFX **Send1** and **Send2** settings to specify the send levels.

The diagram (Fig. 2-5a) shows an example in which the input from a USB-connected external CD drive is panned to left and right, and sent to insert effect 1.

## Disk mode

In Disk mode P1: Play Audio CD as well you can play back an audio CD and process the sound through the insert effects, master effects, and total effects. **Bus Select**, **Send1**, **Send2**, **FX Ctrl Bus**, **REC Bus**, **Pan**, and **Level** are linked with the settings of Sampling mode.

 In Disk mode, effects will use the settings of the mode in which you previously were.

# Mixer

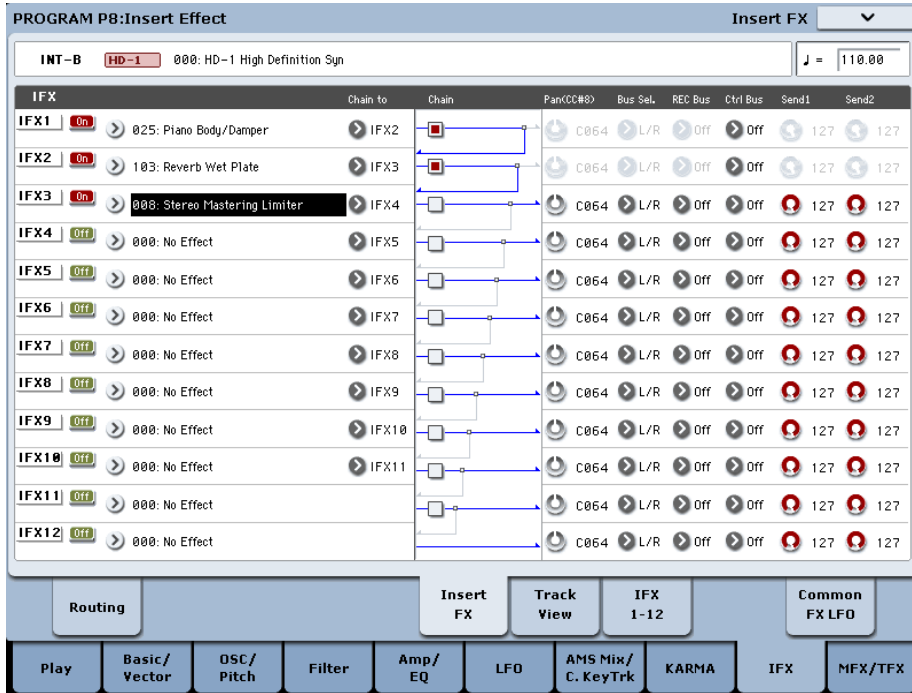

In Program, Combination, and Sequencer modes, the P8 - Insert FX page lets you set “Pan (CC#8)” (post-IFX panning), “Bus Sel. (Bus Select),” “Ctrl Bus” (FX control bus), **REC Bus**, and **Send1** and **Send2** levels to the master effects.

If you have checked the **Chain** to connect the Insert Effects in series, these parameters “Pan (CC#8)” – **Send2** for the post-IFX (last Insert Effect in the chain) signal become effective.

## Pan (CC#8)

This parameter enables you to set the pan of the post-IFX signal.

If you are using the stereo-in/stereo-out Insert Effects, set this parameter to “C064” to enable the **Pan** settings for the oscillators (Program 4–1c, 4–5), timbres (Combination 0–1b), tracks, and audio inputs.

If you are using mono-in/stereo-out or mono-in/mono-out Insert Effects, the **Pan** settings for the oscillators, timbres, tracks and audio inputs are

ignored, and they are set to Center. Use the “Pan (CC#8)” parameter (P8: “Insert FX” page) to set the pan. “L000” is hard left, and “R127” is hard right.

For more about effect types such as stereo-in/stereo-out, see “In/Out” on page 864.

**MIDI** You can control these parameters via CC#8.

## Bus Sel. (Bus Select)

This parameter enables you to specify the destination bus for the post-IFX signals.

“L/R” is a common setting to send signals to the Total Effects (TFX1, TFX2) before they are routed to the OUTPUT (MAIN) L/MONO and R outputs.

Select 1...4 or 1/2...3/4 to route the signals to one of the Individual Outputs. If this is set to 1–4, the output will be monaural. If set to 1/2–3/4, the post-IFX pan settings will be valid, and the output will be stereo. If set to **Off**, the signal will not be sent to the L/R bus or buses 1–4.

Insert Effect = Stereo In - Stereo Out

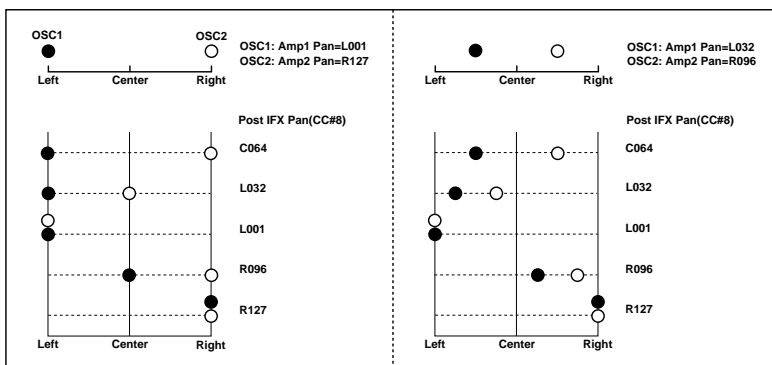

Insert Effect = Mono In - Stereo Out  
Mono In - Mono Out

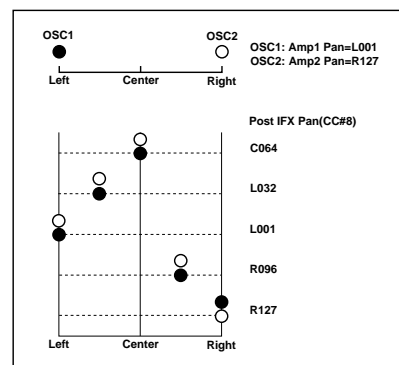

Choose this setting if you want to use the **Send1** or **Send2** levels to route the signal through a master effect in series (i.e., not as a send effect).

### Ctrl Bus (FX Control Bus)

This specifies the FX Control bus that follows the insert effect. The FX Control buses (FX Control 1, 2) are stereo two-channel buses.

The KRONOS provides two (stereo two-channel) effect control buses, giving you a wide range of ways to control effects.

FX Control buses can be used with vocoder, compressor, and gate-type effects.

For details on the effects that be used with FX Control buses, see “FX Control Buses” on page 860.

As an example, here’s how you can use the FX Control bus following an insert effect.

*Example: Gated Reverb*

When using a gate effect with reverberant sound, using the reverberant sound to control the gate may not produce the desired results because the reverb extends the duration of the sound. Normally, you will use the un-reverberated sound to control the gate, as shown in the diagram below.

In this example, we send the sound from the OSC etc. to IFX1 and process it through an equalizer. IFX1 is sent via **Chain** to IFX2 and also sent via “Ctrl Bus” (FX Control Bus) to FX Control 1. The Envelope **Source** of IFX3: Stereo Gate is set to FX Control 1. This allows the gate to be triggered by a signal other than its input (the reverberant sound).

### REC Bus

KRONOS provides two stereo recording (REC) buses: REC 1/2 and REC 3/4.

Using the REC busses, you can isolate one or more sounds for recording or sampling—even if the sounds are also being mixed into the main outputs. For example, you can play a guitar through KRONOS IFX while listening to a KARMA drum phrase, and record the processed guitar without recording the drums.

Individual Programs, Combi Timbres, Sequencer Tracks (both MIDI and Audio), audio inputs, and Insert Effects can all be routed to the REC busses, in addition to their main output/IFX bus settings.

If you don’t need to use the REC bus for a particular sound, turn it **Off**.

Setting the REC bus to 1, 2, 3, or 4 lets you record up to four mono signals simultaneously. Setting it to 1/2 or 3/4 lets you record stereo signals, including the effects of the “Pan (CC#08)” setting.

### Send1, Send2

These parameters enable you to set the send level of the signals routed to Master Effects MFX1 and MFX2. The signal is sent in stereo to master effects MFX1 and MFX2. This is valid when **Bus Select** is L/R or Off.

If you are not using any Insert Effects, use **Send1** and **Send2** of the P8: “Routing” page in Program, Combination, Sequencer, and Song play modes to set the Master Effect send level (Use the P0: Audio Input (/Sampling) page in each mode to set the send level for the audio inputs.).

**MIDI** **Send1** responds to CC#93 and **Send2** responds to CC#91.

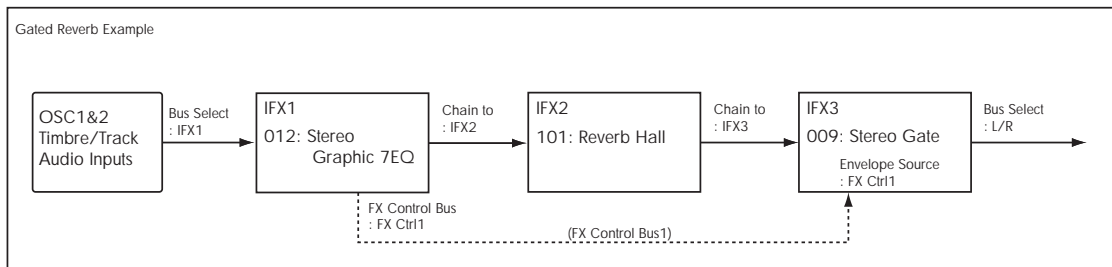

## Controlling the Insert Effects via MIDI

Using the Dynamic Modulation (Dmod) function enables you to control all effect parameters in real-time during performance from the controllers of the KRONOS or a connected MIDI sequencer. You can also control the **Pan (CC#8)**, **Send1**, and **Send2** parameters in the same way.

### Program and Sampling modes

You can control the parameters on the global **MIDI channel**.

### Combination mode

The P8 - IFX1-12 page lets you specify the control channel **Ch** (Control Channel) for IFX1-12. You can choose from CH01-16, Gch, or All Routed.

**Ch01-16:** Select this when you want to control each insert effect from a different channel. An "\*" symbol will be displayed at the right of the MIDI channel Ch01-16 of the timbre that is routed to each insert effect. If the routed timbres have different MIDI channel settings, this parameter is used to specify the channel that will control the insert effect.

**Gch:** Select this option if you wish to control the parameters on the global **MIDI channel**. This is a common setting.

**All Routed:** Select this option to control the parameters on all the channels (channels 1-16 that have a "\*" mark) that are routed to the corresponding Insert Effects.

-  If you've checked "Bus Select DKit" (8-1c) for a timbre for which a drum program is selected, the MIDI channel of that timbre will be valid if any IFX1-12 is set to All Routed, regardless of the drum kit's **Bus Select** settings and the settings of the **Drum Kit IFX Patch** page menu command.

### Sequencer mode

Use "Ch" parameters of the "P8-IFX1-12" pages to set up the control channels for IFX1-12. Select an appropriate option from Ch01-16 and All Routed.

**Ch01-16:** Select this when you want to control each insert effect from a different channel. An "\*" symbol will be displayed at the right of the MIDI channel Ch01-16 of the track that is routed to each insert effect. If two or more tracks with differing MIDI channels Ch01-16 are being sent to a single insert effect, this parameter is used to specify the one track that will control the insert effect.

**All Routed:** Select this option to control the parameters on all the channels (channels 1-16 that have a "\*" mark) that are routed to the corresponding Insert Effects. "All Routed" is a typical option. If you wish to control the parameters on a single channel, you may select it from Ch01-16.

-  If you've checked "Bus Select DKit" for a track for which a drum program is selected, the MIDI channel of that track will be valid if any IFX1-12 is

set to All Routed, regardless of the drum kit's **Bus Select** settings and the settings of the **Drum Kit IFX Patch** page menu command.

*Note:* Since Sequencer mode lets you record and play exclusive messages and edit tracks that include System Exclusive events, you can use them to switch effects or modify effect parameter values during song playback.

# Master Effects (MFX1, 2)

## In/Out

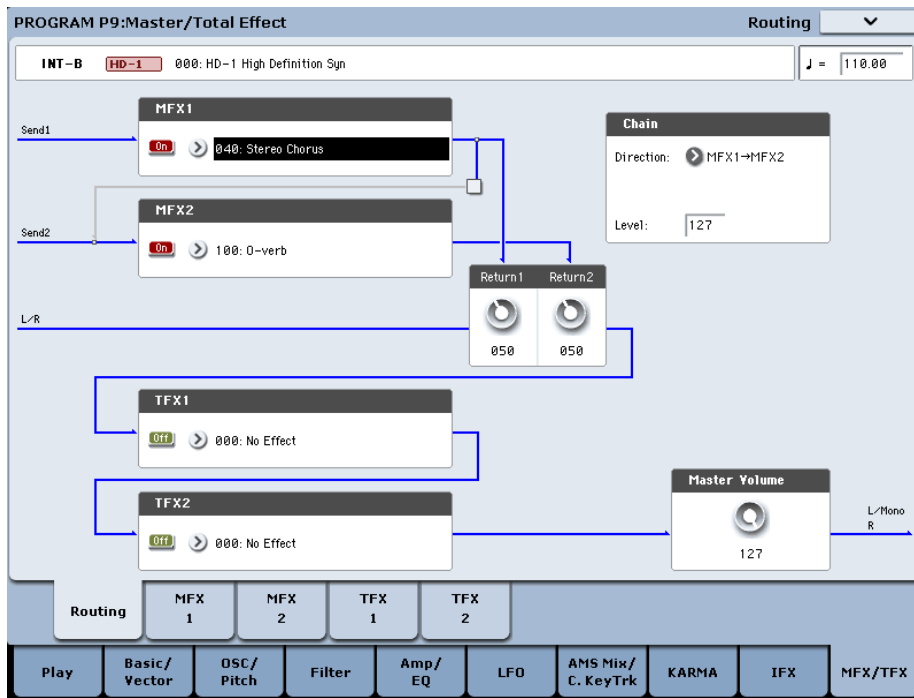

The I/Os of Master Effects MFX1 and MFX2 are stereo-in/stereo-out. **Send1** and **Send2** determine the send level to the Master Effects. (For Send1 and 2, see “Routing” and “Mixer.”)

Master effects will not output the Dry (unprocessed) signal specified in **Wet/Dry** (P9 - MFX1, 2 page). Only the Wet (processed) signal will be output. The output signals from the Master Effects are routed to the L/R bus with the output level specified by **Return1** and “Return2.” These output signals are mixed with the output signals from the bus specified by **Bus Select** (P8: “Routing” page in each mode) L/R, or with the output signals from the bus specified by **Bus Select** (“Insert FX” page in each mode) L/R, then routed to the Master EQ.

Selecting “000: No Effect” will mute the output. The processed signal will be output in one of the following ways, according to the type of effects 001–185.

Wet	Mono In - Mono Out	
	Mono In - Stereo Out	
	Stereo In - Stereo Out	

### Mono-Mono Parallel

141: P4EQ//P4EQ-185: Mt.BPM Dly//Mt.BPM Dly

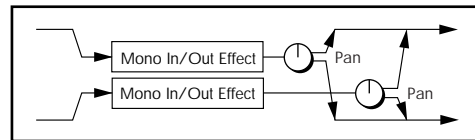

These effects are typically stereo-in/stereo-out, but they have a special structure. The L channel and R channel of the stereo input each have their own independent mono effect. Each mono output can then be panned to the desired position in the stereo field. Normally, you will use these as insert effects, but you can also use them as master effects. For details, see “Mono-Mono Parallel Effects” on page 864.

Pressing the ON/OFF button for MFX1 and 2 of the P9: Routing page in each mode will toggle between ON and OFF. When OFF is selected, the output signals will be muted.

**MIDI** Separately from the setting of this ON/OFF button, MFX1 and MFX2 can be switched off by receiving a MIDI control change CC#94. Value 0 will turn them off, and value 1–127 will turn them on. You can also use “Effect Global SW” (Global 0–1b) to turn MFX1 and 2 on and off. This MIDI control is performed on the global **MIDI channel**.

## Routing

Master effects MFX1 and MFX2 can both be used in any mode. If you are not using any Insert Effects in any mode, the Master Effects send levels are determined by the **Send1 (to MFX1)** and **Send2 (to MFX2)** parameters specified independently for the oscillators (Program/Sampling mode), timbres (Combination mode), tracks (Sequencer mode), and audio inputs (in all modes).

For example, since you can adjust the master effect send levels for each timbre/track, you can make settings so that reverb is applied deeply to the piano, lightly to the strings, and not at all to the bass.

If you're using insert effects, use the post-IFX **Send1** and **Send2** to adjust the send amounts.

### Program mode

Use the **Send1 (to MFX1)** and **Send2 (to MFX2)** parameters of the P8: "Routing" page, or the **Send1** and **Send2** parameters of the P8: "Insert FX" page for the post-IFX1–12 signals, to set the Master Effect send level.

If you have set **Bus Select** to L/R or Off, **Send1 (to MFX1)** and **Send2 (to MFX2)** of the Routing page are effective. These parameters can be set for oscillators 1 and 2 individually. (Fig. 2–1a)

*Note:* You can use the control surface to control Send 1 and 2. For details, see "8–1f: OSC MFX Send" on page 136.

If you have set **Bus Select** to IFX1–12, **Send1** and **Send2** of the Insert FX page for the post-P8-IFX1–12 signals are effective. If you are using the Insert Effects in chain (series), the **Send1** and **Send2** parameters for the post-IFX (last IFX) are effective (Fig 2–1b, 2–1c).

If you have set **Bus Select** to 1–4 or 1/2–3/4, the oscillator signals are output directly to AUDIO OUTPUT (INDIVIDUAL) 1–4.

In this case the Send 1 and Send 2 settings are ignored, and the Master Effects will not be applied (see "Individual Outputs" on page 885).

**MIDI** Send1 responds to CC#93 and Send2 responds to CC#91 on the global MIDI channel. At this time, the actual send level uses the value of the Send 1 and 2 settings for Oscillators 1 and 2, multiplied by the Send 1 and 2 values received via MIDI.

If the Program's **Oscillator Mode** is set to Drums, the "Use DKit Setting" box (Program 8–1b) becomes available. If you check this box, Send1 and Send2 levels for each key of the selected DrumKit become effective. If **Bus Select** is set to L/R or Off for a drum instrument key, **Send1 (to MFX1)** and **Send2(toMFX2)** become effective.

If **Bus Select** is set to IFX1–12, the post-IFX1–12 **Send1** and **Send2** (Program 8–5a) become effective.

If this is unchecked, **Send1 (to MFX1)** and **Send2 (to MFX2)** (Program 8–1f), and the post IFX1–12 **Send1** and **Send2** (Program 8–5a) will be valid for all drum instruments, in the same way as when **Oscillator Mode** is Single or Double, or for EXi programs.

### Combination and Sequencer modes

Use **Send1 (to MFX1)** and **Send2 (to MFX2)** (P8: "Routing" page) for timbres (Combination) and tracks (Sequencer) to set the Send1 and 2 levels for each timbre and track. As with Program mode, if **Bus Select** is set to L/R or Off, **Send1 (to MFX1)** and **Send2 (to MFX2)** become effective.

Fig. 2–1a

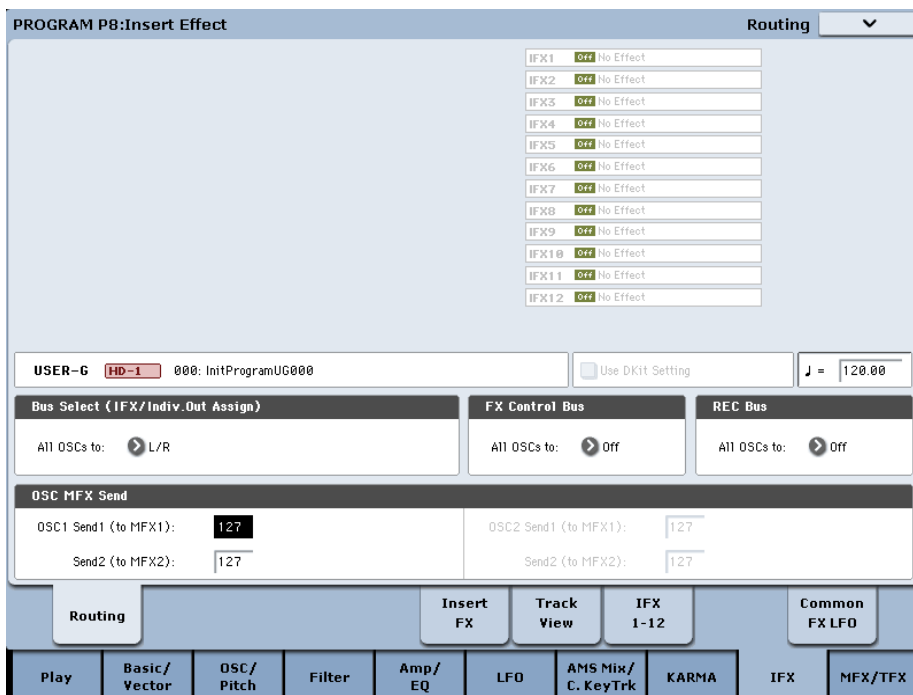

Fig. 2-1b

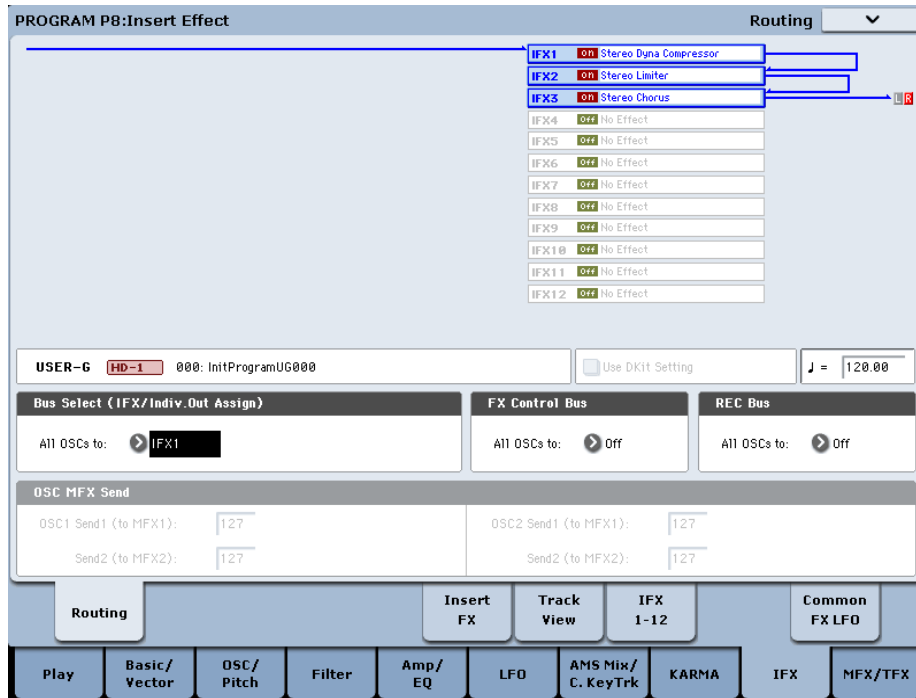
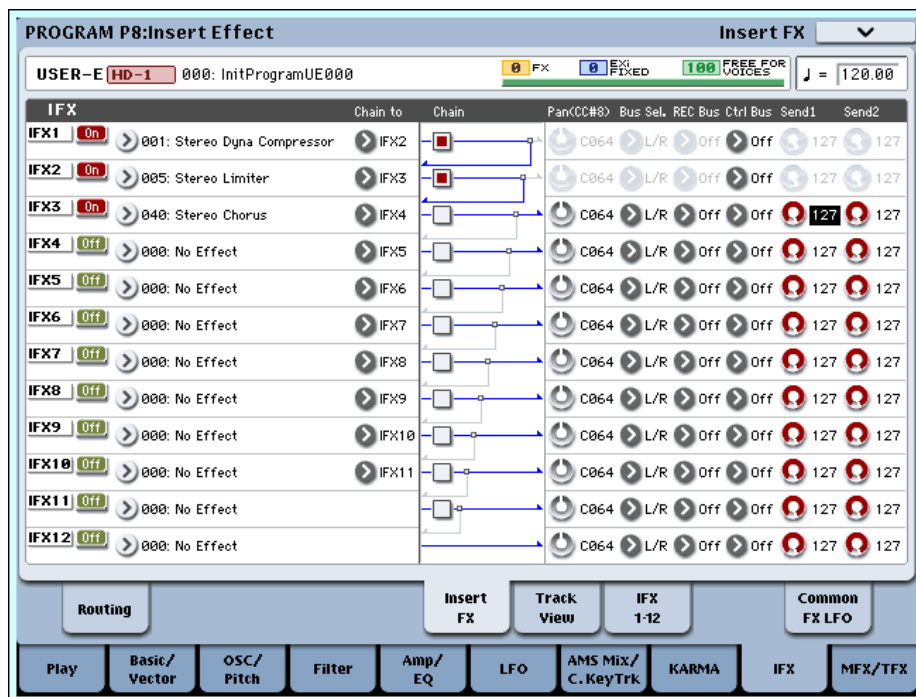

Fig. 2-1c



The actual levels use these Send1 and 2 level values, multiplied by the send level values of oscillators 1 and 2 of the Program P8: "Routing" page.

**Send level**

For example if you set the program's OSC1 Send1 (to MFX1) to 127, Send2 (to MFX2) to 064, OSC2 Send1 (to MFX1) to 064, Send2 (to MFX2) to 127, and the combination's Send1 (to MFX1) to 064 and Send2 (to MFX2) to 127, the actual send levels of the combination will be as follows.

- OSC1/EXi1 Send1=127 (100%) \*064 (50%)=064 (50%)
- OSC1/EXi1 Send2=064 (50%) \*127 (100%)=064 (50%)
- OSC2/EXi2 Send1=064 (50%) \*064 (50%)=032 (25%)

OSC2/EXi2 Send2=127 (100%) \*127 (100%)=127 (100%)

If IFX1-12 is selected for **Bus Select**, use the **Send1** and **Send2** parameters for the post-IFX signals. If 1-4 or 1/2-3/4 is selected instead, these Send1 and 2 settings are ignored and the Master Effect is not applied.



Send1 responds to CC#93, and Send2 responds to CC#91. If **Send1 (to MFX1)** and **Send2 (MFX2)** for each timbre/track are effective, the parameter will be controlled on the MIDI channels set for the corresponding timbres and tracks. If the **Send1** and **Send2** parameters for the post-IFX1-12 signals are effective, they can be controlled on the MIDI channels assigned to IFX1-12.



*Note:* You can use the control surface to control Send1 and 2. For details, see “8–1f: OSC MFX Send” on page 136.

An example for Combination mode is given below. In the upper figure (Fig. 2–2a), **Bus Select** is set so that Timbre 1 is routed to IFX1, Timbre 2 to IFX2, Timbre 3 to IFX3, Timbre 4 to IFX4, Timbres 5 and 6 to IFX5, and Timbres 7 and 16 to L/R. In this case, use **Send1** and **Send2** for the post-IFX1 (001:St. Dyna Compressor) signal to set the send level of the Timbre 1 routed to the Master Effect. (In this example they are set to 032 and 127.) In the same way, use **Send1** and **Send2** for the post-IFX2, 3, and 4 signals to set the send levels of Timbres 2, 3, and 4, and use the **Send1** and **Send2** parameters for the post-IFX5 signal to set the send levels of Timbres 5 and 6. For Timbres 7 and 16, the settings of **Send1** (to **MFX1**) and **Send2** (to **MFX2**) will be effective. (At this time, the actual send levels use these Send 1 and 2 values multiplied by the Send1 and 2 settings for Program oscillators 1 and 2.)

“Bus Select DKit” is valid if you’ve selected a drum track for a Timbre (Combination) or Track (Sequencer).

Fig. 2–2a

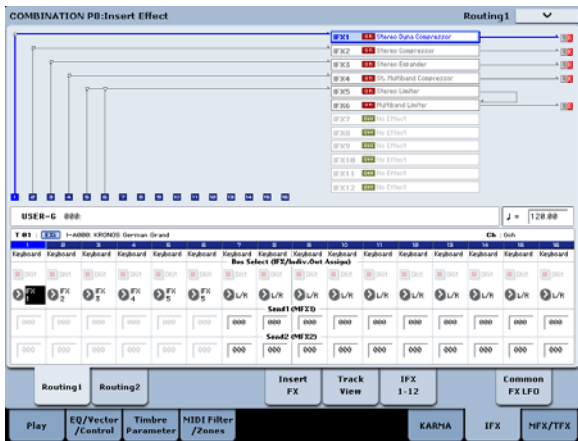

If you select **DKit**, the **Bus Select** settings for each key become effective, and each drum instrument sound will be routed to the corresponding buses. At this time, the actual send levels use these Send 1 and 2 values, multiplied by the Send1 and 2 settings for each DrumKit key.

If a drum kit’s **Bus Select** is set to L/R or Off, the levels will be these Send 1 and 2 settings multiplied by the send levels you specify in Program P8: Routing page for OSC1 **Send1** (to **MFX1**) and **Send2** (to **MFX2**) (Program 8–1d), just as in other cases (**Oscillator Mode** Single or Double).

If **Bus Select** is set to IFX1–12, use **Send1** and **Send2** for the post-IFX signal. If **Bus Select** is set to 1–4 or 1/2–3/4, the Send 1 and 2 settings will be ignored.

Fig. 2–2b

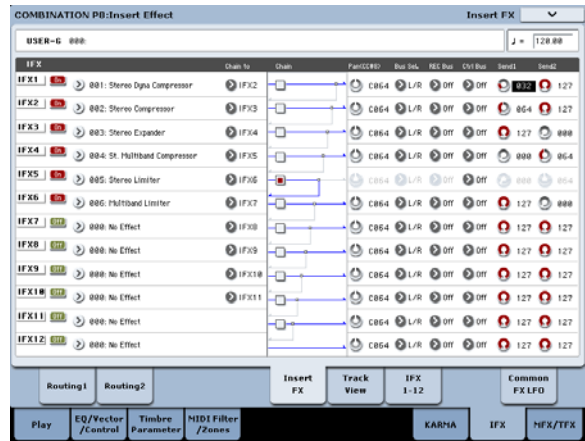

### Sampling mode

You can apply insert effects, master effects, and total effects to an external audio source (analog, S/P DIF, or USB), and sample the result. You can also apply insert effects, master effects, and total effects to samples assigned to a multisample, and resample the result.

Use the P0– Audio Input page to make settings for external audio sources.

The **Bus Select** setting for each jack specifies the bus to which the external input source will be sent. You can choose from L/R, IFX1–12, 1–4, 1/2–3/4, or Off. If **Bus Select** is set to L/R or Off, use **Send1** (to **MFX1**) and **Send2** (to **MFX2**) to adjust the send levels to the master effects. If **Bus Select** is set to IFX1–12, use the post-IFX **Send1** and **Send2** to adjust the send levels to the master effects.

If you want to apply the master effects to the samples of a multisample and play or resample the result, use the P8 - Routing page settings **Send1** (to **MFX1**) and **Send2** (to **MFX2**) or the P8 - Insert FX page settings post-IFX1–12 **Send1** and **Send2** settings to adjust the send levels to the master effects.

**MIDI** Send1 can be controlled by receiving CC#93, and Send2 by receiving CC#91. These parameters are controlled on the global **MIDI channel**.

*Note:* You can use the control surface to control Send 1 and 2. For details, see “8–1f: OSC MFX Send” on page 136.

### Audio Input, S/P DIF IN

In Program, Combination, Sequencer, and Disk modes, external audio sources from the audio inputs (analog, S/P DIF, and USB) can be processed by insert effects, master effects, and total effects just as they can in Sampling mode.

In the P0– Audio Input/Sampling page of each mode, the **Use Global Settings** parameter makes settings for all of the audio inputs (analog, S/P DIF, and USB).

Set **Bus Select** to specify the bus to which the external audio input will be sent. You can select L/R, IFX1–12, 1–4, 1/2–3/4, or Off. If **Bus Select** (Global P0: 0–3a) is set to L/R or Off, adjust the send levels to the master effects using **Send1** (to **MFX1**) and **Send2** (to **MFX2**). If

**Bus Select** is set to IFX1–12, use the post-IFX **Send1** and **Send2**. If this is set to individual outputs 1–4 or 1/2–3/4, the signal will not be sent to the master effects.

 In Disk mode, effects will use the settings of the mode in which you previously were.

*Note:* You can use the control surface to control Send 1 and 2. For details, see “8–1f: OSC MFX Send” on page 136.

## Audio CD

In Sampling mode you can apply the insert effects, master effects, and total effects to the sound of an audio CD from the internal CD-R/W or a USB-connected external CD drive.

In the P5: Audio CD page, use “Drive Select” to select the drive from which you want to input CD audio, and use **Bus Select** to select the bus to which you want to

send the CD audio. You can choose from L/R, IFX1–12, 1–4, 1/2–3/4, and Off. If you want to send the CD audio to the master effects and **Bus Select** is set to L/R or Off, adjust **Send1 (to MFX1)** and **Send2 (to MFX2)**. If **Bus Select** is set to IFX1–12, adjust the post-IFX **Send1** and **Send2**. If **Bus Select** is set to 1–4 or 1/2–3/4, the CD audio will not be sent to the master effect.

## Disk mode

In the Disk mode P1– Play Audio CD page as well, you can play back an audio CD and apply the insert effects, master effects, and total effects to the playback. **Bus Select**, **Send1 (to MFX1)**, **Send2 (to MFX2)**, **FX Ctrl Bus**, **REC Bus**, **Pan**, and **Level** are linked with the settings of Sampling mode.

 In Disk mode, effects will use the settings of the previously selected mode.

## Mixer

The input levels to the master effects are determined by the send levels. In the P9: Routing page of each mode, you can specify the output level and chaining (series connection) between the two master effects.

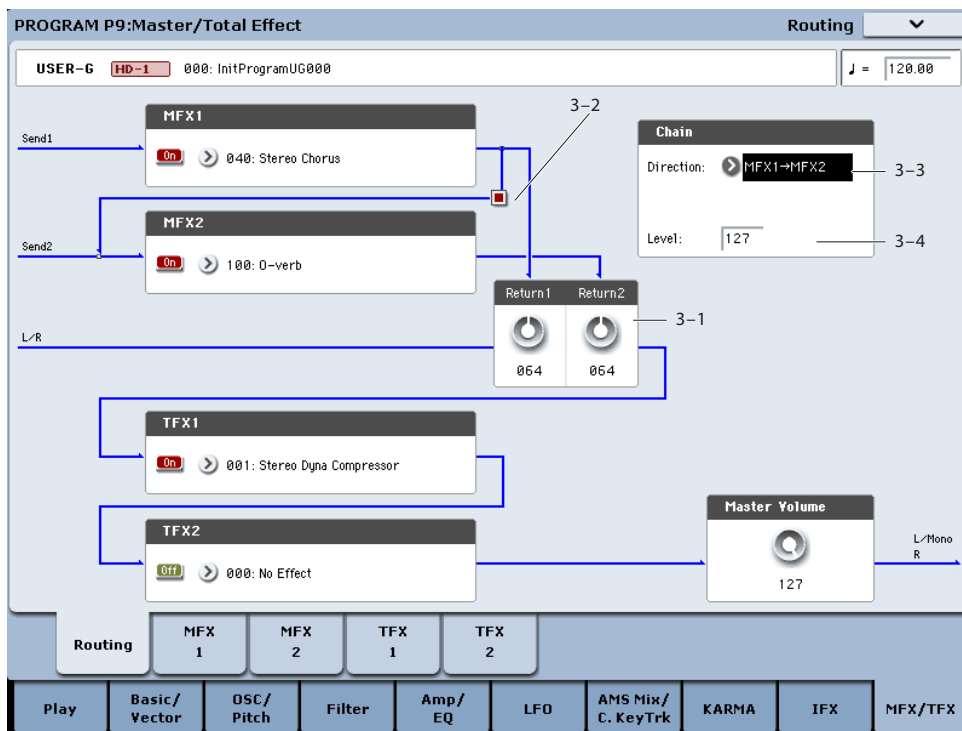

## Return1, Return2

These adjust the amount of signal that is returned from the master effects MFX1 and MFX2 outputs to the L/R bus.

The left-side value of the **Wet/Dry** parameter for the MFX1 or 2 effect is the output level of that master effect. (In other words if **Wet/Dry** is 25:75, the output level is 75%. It is 100% if Wet, and 0% if Dry.) The **Wet/Dry** value multiplied by the **Return1** or **Return2**

value is sent to the L/R bus and mixed with the P8 - Routing page **Bus Select** L/R or Insert FX page **Bus Select** L/R output.

For example, with MFX1 **Wet/Dry** set to 50:50 (50%) and **Return1** set to 64 (50%), the resultant effect level will be 25%. The effect level is maximum (100%) when **Wet/Dry** is set to “Wet” and **Return1** is set to 127.

---

### Chain check box

Press this box to chain MFX1 and MFX2 to each other. In the example shown in the preceding page, the output of MFX1 (Stereo Chorus) is added to the input of MFX2 (Reverb Hall).

---

### Chain Direction

If you have checked the **Chain** box, you can set the direction of the connection here. You can also visually confirm the direction on the LCD.

---

### Chain Level

This parameter determines the level of signals routed from one MFX to the other MFX in a chain connection.

---

## Controlling the Master Effects via MIDI

In the same way as for insert effects, parameters of the master effects can also be controlled in realtime via Dynamic Modulation (Dmod) from the KRONOS's controllers or an external MIDI device during performance or from the sequencer.

---

### Program and Sampling modes

Effect parameters are controlled on the global **MIDI channel**.

---

### Combination and Sequencer modes

In Combination and Sequencer modes, the control channel for MFX1 and MFX2 are specified by the **Ch** (Control Channel) setting in the MFX1 and 2 pages. You can choose Ch01–16 or Gch.

**Ch01–16:** Select this option if you wish to control the parameters for each Master Effect on different channels.

**Gch:** Select this option if you wish to control the parameters on the global **MIDI channel**. This is the normal setting.

*Note:* Since Sequencer mode lets you record and play exclusive messages and edit tracks that include System Exclusive events, you can use them to switch effects or modify effect parameter values during song playback.

# Total Effects (TFX1, 2)

## In/Out

The total effects TFX1 and TFX2 are stereo-in and stereo-out. The Dry (unprocessed) side of the **Wet/Dry** parameter sends the stereo input sound directly to the stereo output. The way in which the Wet (processed) side is output depends on the type of effect, as follows.

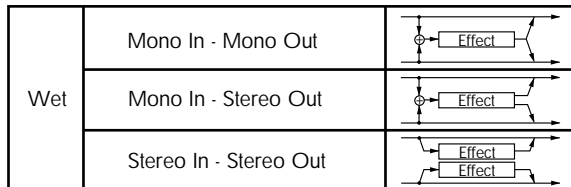

### Mono-Mono Parallel

141: P4EQ/P4EQ-185: Mt.BPM Dly//Mt.BPM Dly

For details, see “Mono-Mono Parallel Effects” on page 864.

If you select 000:No Effect, the stereo input will be passed to the stereo output without any processing.

You can switch the effects on/off using the MFX1 or 2 ON/OFF buttons or the P9 - Routing settings in each mode. When off, the effect will be bypassed. The stereo input will be passed to the stereo output without any processing, just as if 000:No Effect is selected.

**MIDI** Separately from this ON/OFF button, MIDI control change CC#95 can be received to turn TFX1 and TFX2 off. A control change value of 0 turns them off, and a value of 1–127 restores them to the prior setting. You can also use “Effect Global SW” to turn off TFX1 and TFX2 in the same way. This is controlled on the global **MIDI channel**.

## Routing

The total effects TFX1 and TFX2 are placed immediately before the AUDIO OUTPUT (MAIN) L/MONO and R outputs. Both effects (TFX1 and 2) are available in all modes.

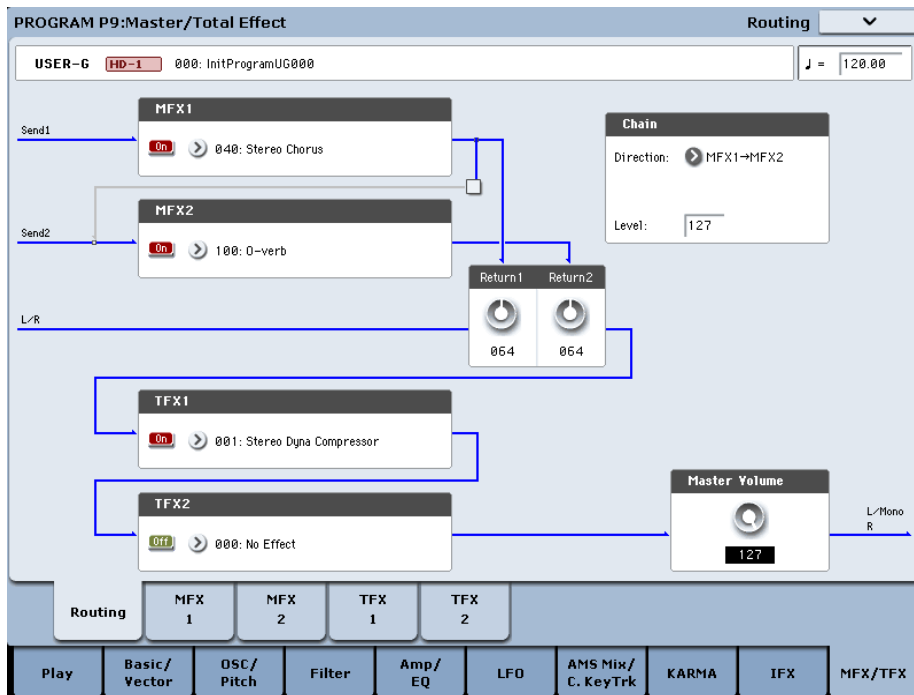

If the **Bus Select** setting for an oscillator (Program/Sampling modes), timbre (Combination mode), track (Sequencer mode), or audio input (in all modes) or the post-insert **Bus Select** is set to L/R, the signal will be output from the AUDIO OUTPUT (MAIN) L/MONO and R jacks.

The sound from MFX1 and 2 is routed through TFX1 and TFX2, and then output to AUDIO OUTPUT (MAIN) L/MONO and R.

---

## Mixer

---

### Master Volume

This sets the level of the final output after passing through the total effects.

*Note:* You can use the control surface to control the master volume. Master volume can also be controlled from the P0- Control Surface page.

---

## Using MIDI to control the Total Effects

In the same way as for Insert and Master Effects, the Total Effects can be controlled in realtime via Dynamic Modulation (Dmod). You can use either the built-in KRONOS's controllers or an external MIDI device, during live performance or from a sequencer.

---

### Program and Sampling modes

Effect parameters are controlled on the global MIDI channel.

---

### Combination and Sequencer modes

In Combination and Sequencer modes, the control channel for TFX1 and TFX2 are specified by the **Ch** (Control Channel) setting in the TFX1 and 2 pages. You can choose Ch01-16 or Gch.

**Ch01-16:** Choose from these settings if you want to control each total effect on a separate channel.

**Gch:** Choose this setting if you want to control the total effects on the global **MIDI channel**.

*Note:* In Sequencer mode, you can record and play back exclusive messages, and edit tracks that include System Exclusive events. This lets you switch effects or vary the value of effect parameters while a song plays.

## Outputs

---

### Main Outputs

The main L/MONO and R outputs of the KRONOS are output from the AUDIO OUTPUT (MAIN) L/MONO and R jacks, the S/P DIF OUT (MAIN) jack, and the headphone jack.

---

### Individual Outputs

The KRONOS is equipped with four individual audio outputs, which can be used as individual mono outputs, stereo pairs, or any combination of the two. Almost any signal source can be routed to these outputs, including:

- Each note in a Drum Kit
- Insert Effect outputs
- Each Program in a Combination or Song
- Audio tracks
- Audio inputs

You can use these to isolate or group together sounds for recording, or for complex live performance setups.

If the signal is going through one or more insert effects, the output is set at the last IFX in the chain, via the **Bus Select** parameter on the P8-5 Insert Effects page.

If a Program, Timbre, or Track is *not* going through any insert effects, the output is set using the **Bus Select** parameters on the P8-1 or 8-2 Routing page.

To assign audio inputs directly to outputs, use **Bus Select** parameters in the P0– Audio Input (Sampling) page.

In Global mode, the Audio page **L/R Bus Indiv. Assign** setting lets you mirror the MAIN stereo L/R output on any pair of individual outputs. You can use this to create a private monitoring setup in live and studio environments. For more information, see “L/R Bus Indiv. Assign” on page 761 of the Parameter Guide.

*Note:* You can't use the VOLUME knob to adjust the volume of the individual outputs.

# Effect/Mixer Block Diagrams

Program mode

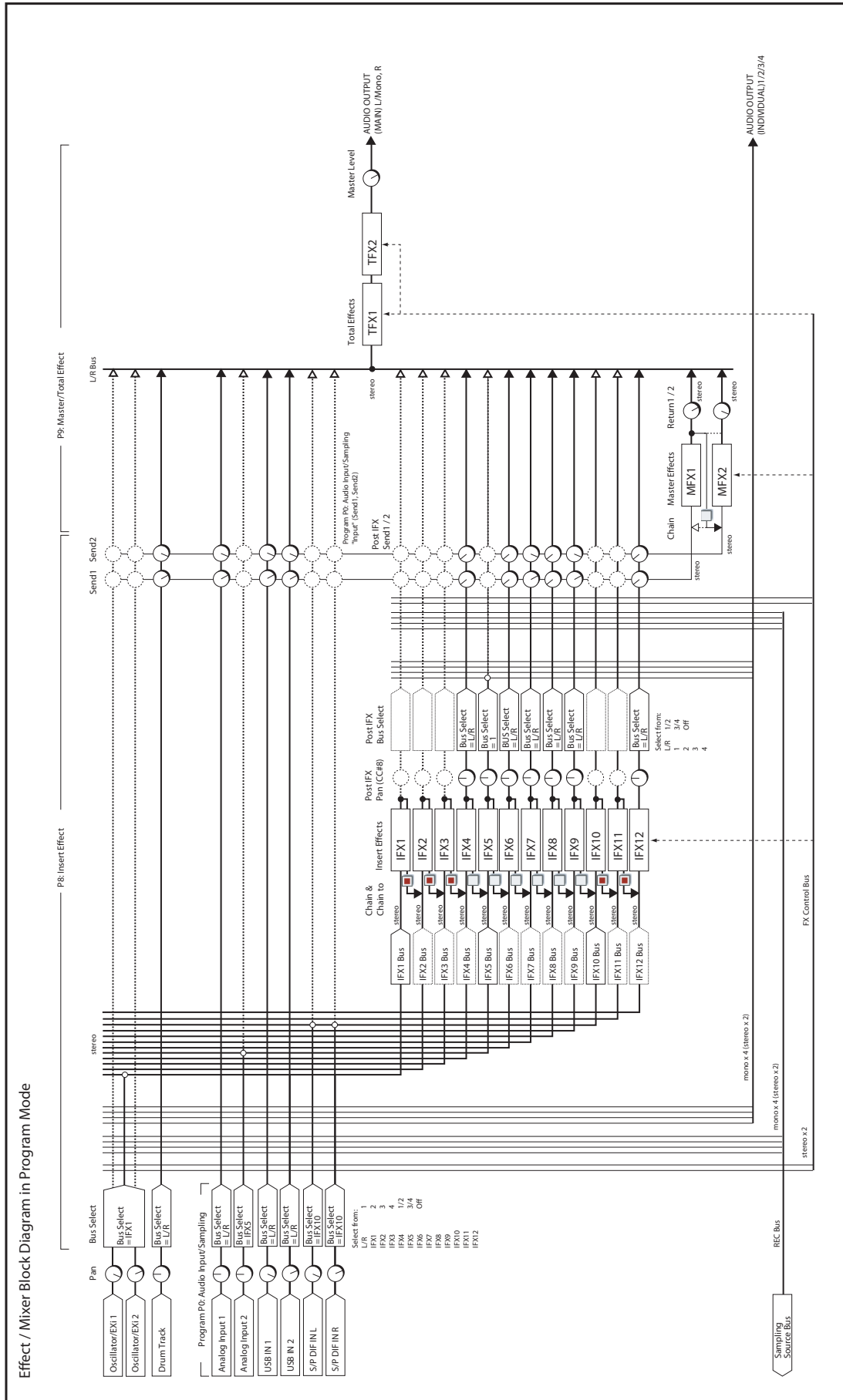



Combination mode, Sequencer mode

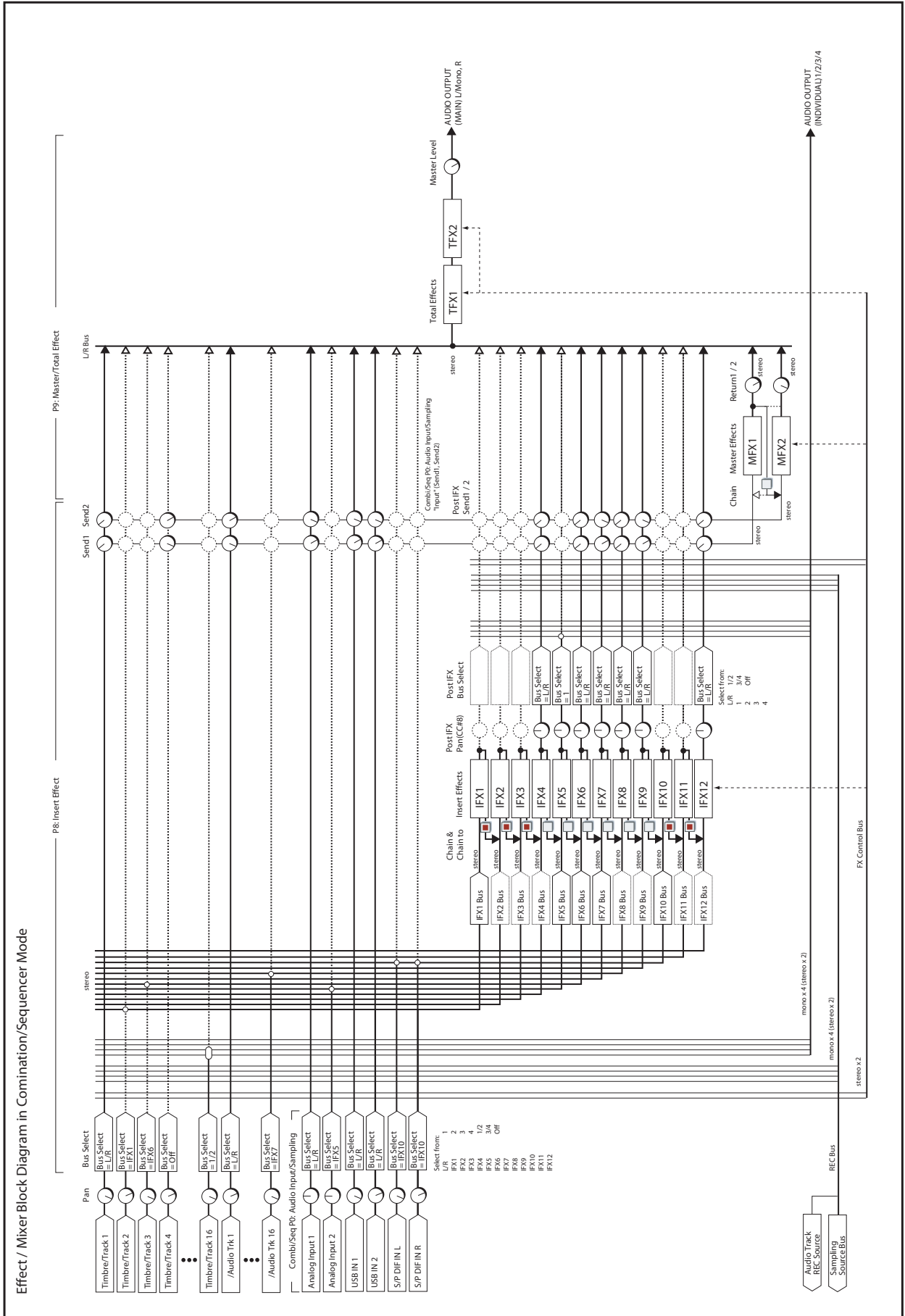

Sampling mode

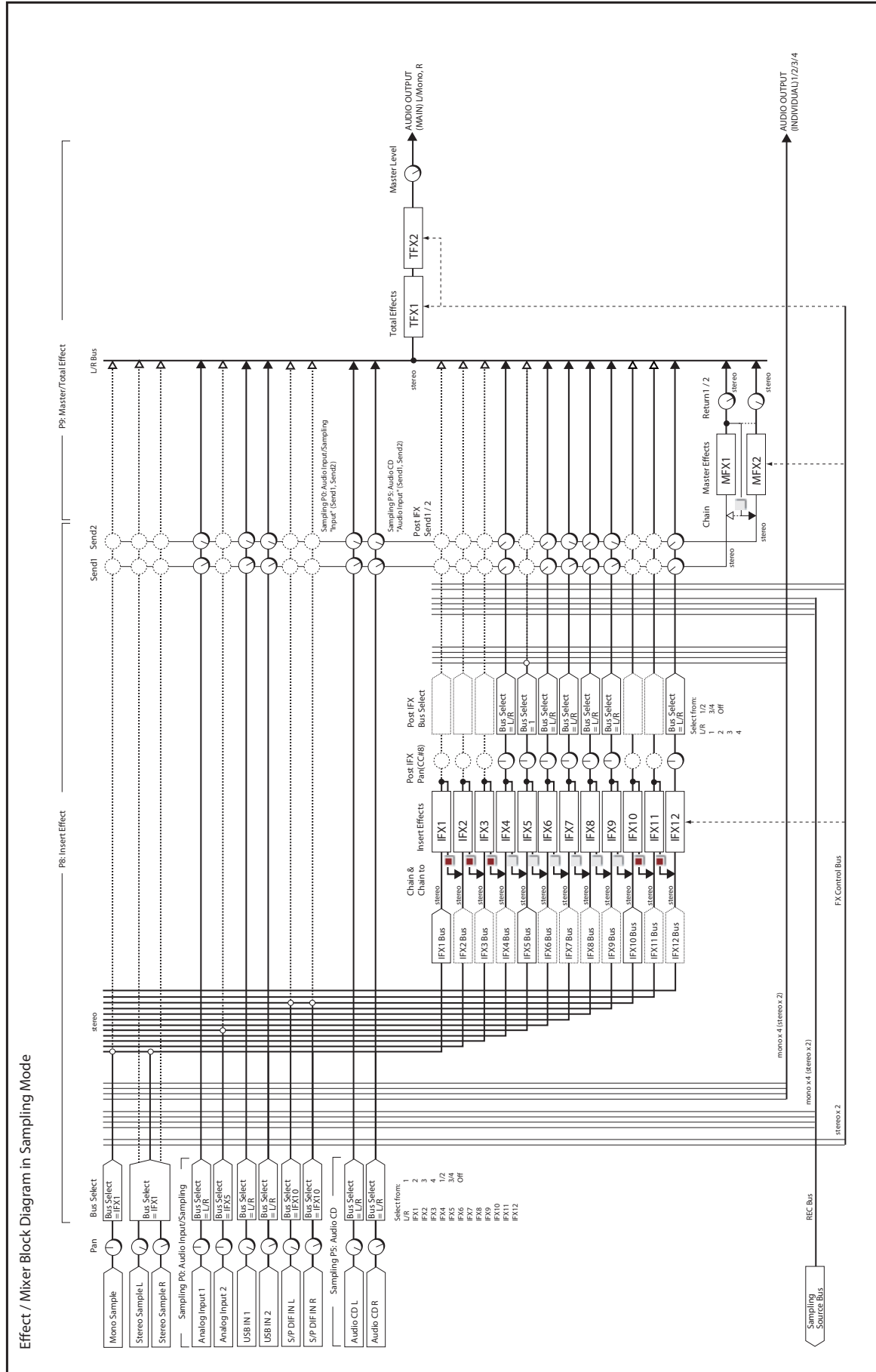

## Dynamics

### 000: No Effect

Choose this option when you are not using the selected effects slot. This frees up processing resources for other effects and/or synth voices.

When a slot is set to **No Effect**:

- Insert Effects and Total Effects pass through the dry, unprocessed signal
- Master Effects mute their outputs

### 001: Stereo Dyna Compressor

*On-screen graphic, 001 Stereo Dyna Compressor*

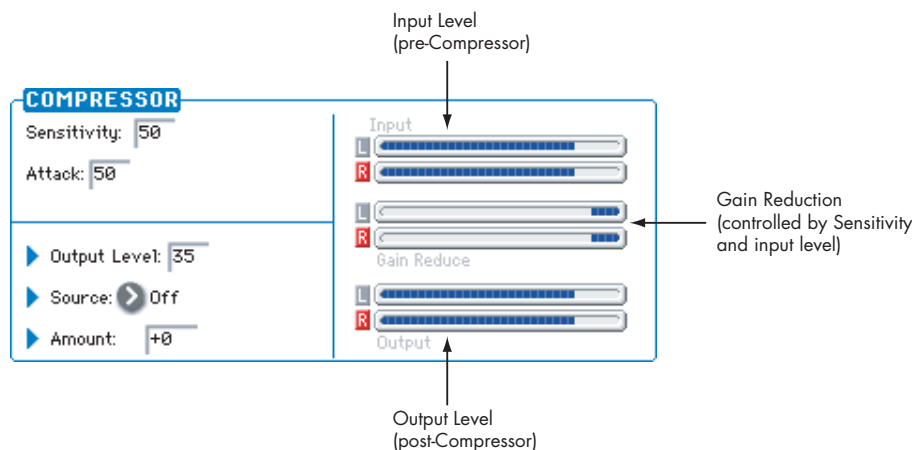

This effect reduces the dynamic range of the input signal, to regulate the level and give a “punchy” effect. It is useful for guitar, piano, and drum sounds. This is a true stereo effect; you can link the left and right channels, or use each channel separately.

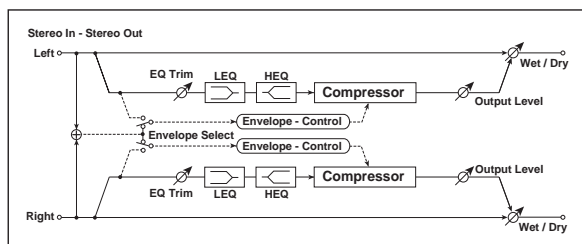

#### ENVELOPE

##### Select [L/R Mix, L/R Individually]

This determines how the left and right channels of the selected **Source** are used for controlling the compressor. Note that this applies only to the control signal; the effect always processes both channels of the input signal in stereo.

**L/R Mix** is generally the best choice for stereo signals; this compresses both channels equally, based on the combined volumes of the left and right channels.

**L/R Individually** splits the effect into two separately controlled mono compressors. When processing stereo signals, this will cause the stereo image to shift.

#### Pre EQ

##### Trim [0...100]

This sets the input level for the EQ.

##### LEQ Fc [Low, Mid-Low]

Selects the frequency of the EQ's low band.

##### LEQ Gain [dB] [-15.0...+15.0]

Sets the gain of the Low EQ.

##### HEQ Fc [High, Mid-High]

Selects the frequency of the EQ's high band.

##### HEQ Gain [dB] [-15.0...+15.0]

Sets the gain of the High EQ.

#### COMPRESSOR

##### Sensitivity [1...100]

This controls the amount of compression. Increasing the value boosts lower level sounds, and raises the overall volume.

To adjust the final volume, use the **Output Level** parameter.

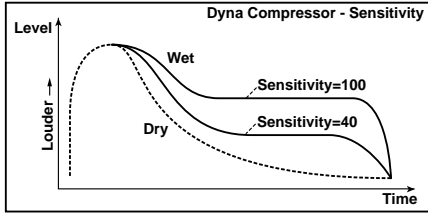

**Attack** [1...100]

This controls the onset time of the compressor.

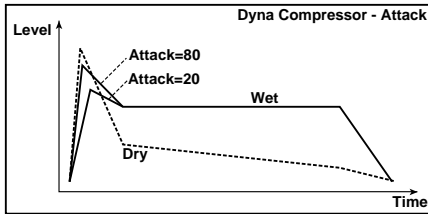

**Output Level**  $D_{mod}$  [0...100]

Sets the output level of the compressor.

**Source** [Off...Tempo]

Selects the modulation source for the **Output Level**.

**Amount** [+/-100]

Sets the modulation amount for the **Output Level**.

**OUTPUT**

**Wet/Dry**  $D_{mod}$  [Dry, 1:99...99:1, Wet]

Sets the balance between the “wet” processed sound and the dry input.

**Source** [Off...Tempo]

Selects a modulation source for **Wet/Dry**.

**Amount** [+/-100]

Sets the modulation amount for **Wet/Dry**.

**002: Stereo Compressor**

On-screen graphic, 002 Stereo Compressor

The yellow line shows the output level, relative to the input level. This will change according to the Ratio, Threshold, and Soft Knee Width.

These lights show the relation of the control input to the Threshold and Soft Knee, in real-time. Under (green) means the input is below the Soft Knee area, and so no compression is occurring. Knee (yellow) means that the input is within the Soft Knee range. Within this range, as the signal gets louder, the amount of compression will gradually increase towards the Ratio setting. Over (red) means that the input is above the Soft Knee range, and the full Ratio is being applied.

This is a sophisticated stereo compressor that allows you to make detailed settings, such as the level detection method and the compression curve.

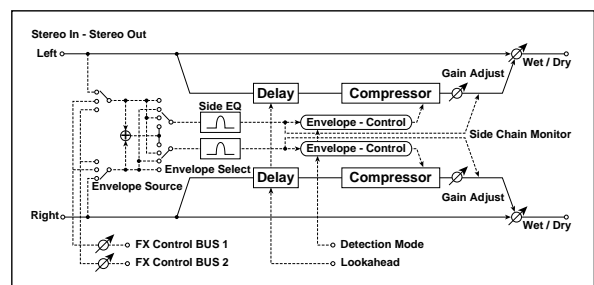

## ENVELOPE

**Source** [Input, FX Control 1, FX Control 2]

The action of the compressor is controlled by the level of the selected **Source**.

**Input** is the normal setting, in which the level of the input signal controls the compressor.

**FX Control 1** or **2** let you process the input signal with the compressor, while using a completely different signal to control it. For instance, you might use a different **Timbre** or **Track** to duck the input signal. For more information, please see “FX Control Buses” on page 860.

**Select** [L/R Mix, Left, Right, L/R Individually]

This determines how the left and right channels of the selected **Source** are used for controlling the compressor. Note that this parameter applies only to the control signal; the effect always processes both channels of the input signal in stereo.

**L/R Mix** is generally the best choice for stereo signals; this compresses both channels equally, based on the combined volumes of the left and right channels.

**L Only** and **R Only** use only the selected channel for controlling the limiter; the other channel is ignored.

**L/R Individually** splits the effect into two separately controlled mono compressors. When processing stereo signals, this will cause the stereo image to shift.

**Fx Control Trim** [0...100]

This adjusts the level of the FX Control Bus inputs.

**Detection Mode** [RMS, Peak]

**RMS** bases the amount of compression on the average level, which tends to sound more natural in most cases.

**Peak** does not do this averaging, and so the compressor responds more quickly to sudden jumps in level.

Choose **RMS** if you want to make the overall volume more consistent, or choose **Peak** if you want to be sure that even sudden peaks are suppressed.

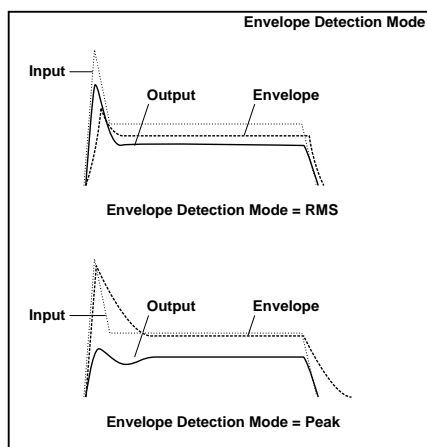

**Side Chain Monitor** [Check-box]

When this is **On**, you'll hear the control signal (as selected by the **Source** parameter) through the sidechain EQ, instead of the output of the limiter. This can be helpful when you're tuning the EQ to emphasize or de-emphasize specific frequencies.

To hear the output of the limiter, set this to **Off**.

## SIDE CHAIN EQ

This multimode filter applies only to the control signal, and not to the main audio path. Use it to alter the response of the compressor so that it reacts (or does not react) only to specific frequencies.

For instance, if you want the compressor to ignore cymbal crashes, adjust the sidechain EQ to reduce the gain of frequencies specific to the cymbals. While doing so, it may help to turn on the **Side Chain Monitor** switch, so that you can listen as you hone in on the desired frequencies.

**EQ On** [Check-box]

Switches the EQ on and off.

**Type** [Low Pass, Band Pass, High Pass, Band Reject]

Selects the type of filter for the sidechain. For more information, see “Filter Type” on page 70.

**Frequency [Hz]** [20...20.00k]

Sets the filter's cutoff frequency.

**Q** [0.5...10.0]

Sets the bandwidth of the EQ.

## COMPRESSOR

**Ratio** [1.0:1...50.0:1, Inf:1]

This determines how strong the effect of the compressor will be, expressed by how many dB in input level over the **Threshold** is required for a 1dB change in output level.

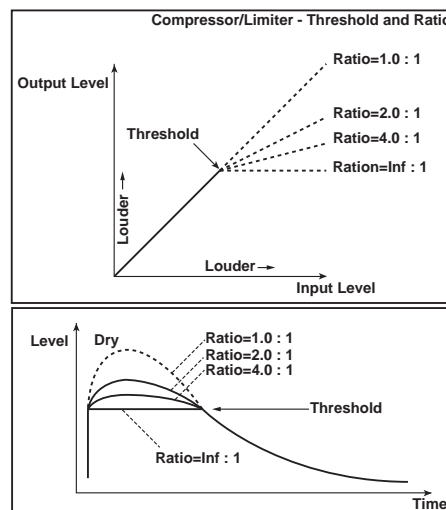

At **1.0:1**, the compressor has no effect. At **20.00:1**, a 20dB increase in the input level (over the **Threshold**) results in only a 1dB change in output. At **Inf:1**, the

compressor becomes a brick-wall limiter; once the signal hits the **Threshold**, the output level will no longer increase, regardless of the input level.

**Threshold [dB]** [-40...0]

Compression happens only when the input signal exceeds this level. Input levels above the threshold will be compressed, and input levels below the threshold will not be compressed.

**Soft Knee Width [dB]** [0...30]

Increasing this value will produce a more gentle volume change around the Threshold level.

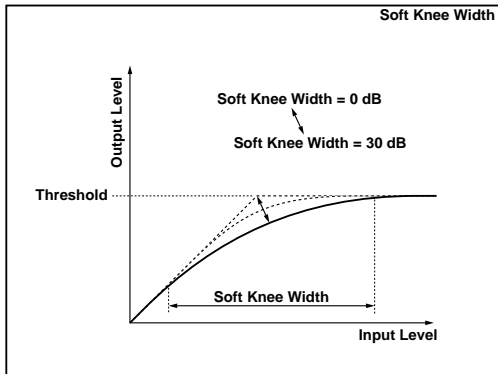

**Attack [msec]** [0.45...500.0]

This determines how quickly the compressor will take affect after the signal crosses above the threshold.

**Release [msec]** [5...5000]

This controls how quickly the compressor will stop reducing volume level after the signal falls below the threshold.

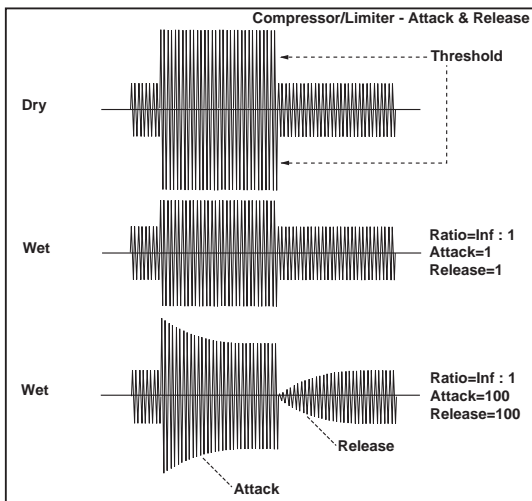

**Lookahead** [Check-box]

If this is on, the input signal to the compressor is delayed so that the level will be detected from the trigger input before the input signal is actually processed. This allows compression to accurately follow changes in the trigger input.

**Gain Adjust [dB]**  $D_{mod}$  [-Inf, -38...+24]

Sets the output gain. It's often useful to increase the gain, since compression causes the entire level to be reduced.

**Source** [Off...Tempo]

Selects the modulation source for the output gain.

**Amount** [-63...+63]

Sets the amount of output gain modulation.

**OUTPUT**

This is the standard effects output section, with modulatable control over wet/dry balance. For more information, see "OUTPUT" on page 890.

## 003: Stereo Expander

On-screen graphic, 003 Stereo Expander

The yellow line shows the output level, relative to the input level. This will change according to the Ratio, Threshold, and Soft Knee Width. The expander lowers the level when the input signal is below the Threshold, to the left of the gray area. In the example shown here, a -30 dB input results in -40 dB output, while a -5 dB input passes through unchanged.

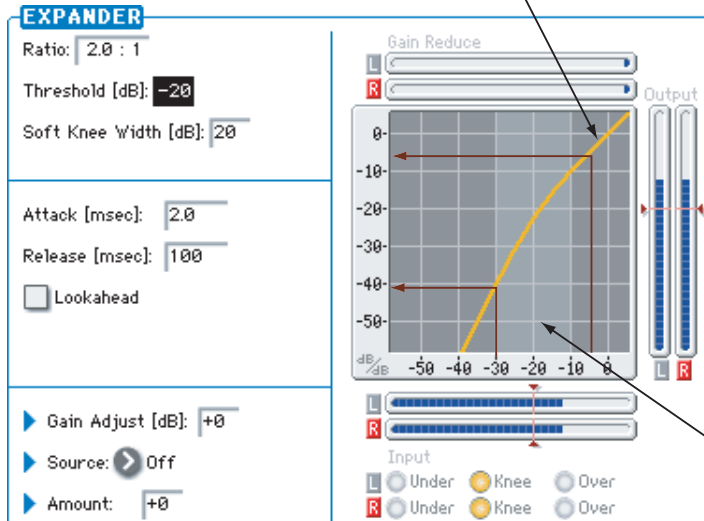

Please see the description of the Stereo Compressor for more information on the graphic display.

The light gray area shows the Soft Knee Width. Notice how the slope of the yellow line changes as it passes through this range.

An expander is like the opposite of a compressor: it makes quiet signals more quiet. You can use this to increase dynamic range, emphasizing the differences between soft and loud.

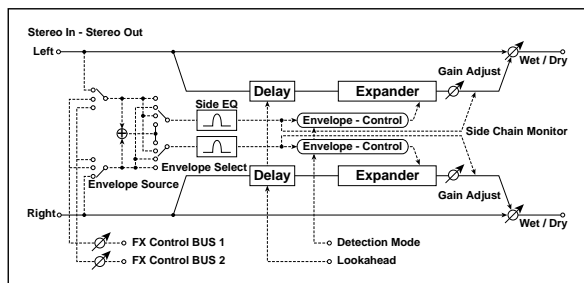

### ENVELOPE

This part of the effect allow you to select and listen to the control signal, adjust the input level of the FX Control Buses, and select between RMS and Peak detection modes. The parameters are the same as for the Stereo Compressor; for more information, see "ENVELOPE" on page 891.

### SIDE CHAIN EQ

This multimode filter applies only to the control signal, and not to the main audio path. Use it to alter the response of the expander so that it reacts (or does not react) only to specific frequencies. The parameters are the same as for the Stereo Compressor; for more information, see "SIDE CHAIN EQ" on page 891.

### EXPANDER

**Ratio** [1.0:1...10.0:1]

Sets the signal compression ratio.

**Threshold [dB]** [-40...0]

Sets the level above which the compressor is applied. For more information, see "Threshold [dB]" on page 892.

**Soft Knee Width [dB]** [0...30]

Sets the curve at which compression is applied. p.892.

**Attack [msec]** [0.45...500.0]

Sets the attack time. For more information, see "Attack [msec]" on page 892.

**Release [msec]** [5...5000]

Sets the release time. For more information, see "Release [msec]" on page 892.

**Lookahead** [Check-box]

Switches level detection look-ahead (expander input delay) on/off. For more information, see "Lookahead" on page 892.

**Gain Adjust [dB]** [-Inf, -38...+24]

Sets the output gain.

**Source** [Off...Tempo]

Selects the modulation source for the output gain.

**Amount** [-63...+63]

Sets the modulation amount of the output gain.



## OUTPUT

This is the standard effects output section, with modulatable control over wet/dry balance. For more information, see “OUTPUT” on page 890.

## 004: St.Multiband Compressor

On-screen graphic, 004 St. Multiband Compressor crossover

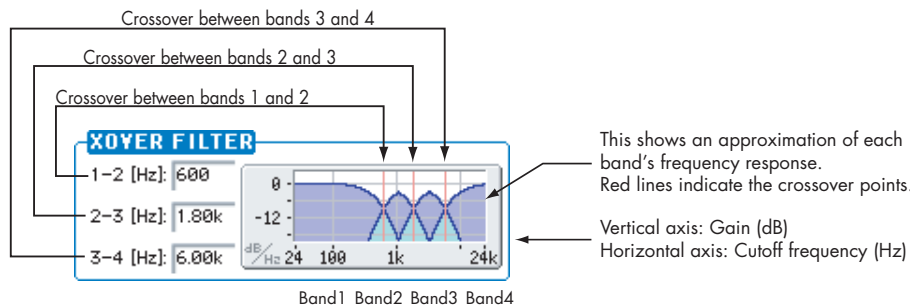

This stereo effect divides the input signal into four bands, low through high, with separate dynamics control of each band. While it’s named a “compressor,” it’s actually much more than that. It can be used as a compressor, expander, gate, or EQ—with each band performing a different function, if desired.

The dynamics processing works somewhat differently than a standard compressor/expander. For more information, see “Range [dB],” below.

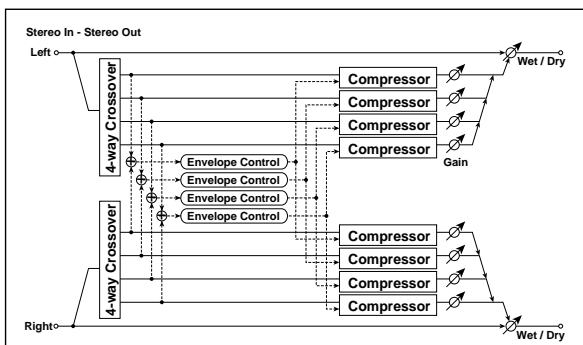

### XOVER FILTER

**Slope** [6dB Oct, 12dB Oct, 18dB Oct, 24dB Oct]

Selects the steepness of the crossover filters.

**Frequency 1-2 [Hz]** [40...240]

Sets the frequency at which bands 1 and 2 are divided.

**Frequency 2-3 [Hz]** [100...6.00k]

Sets the frequency at which bands 2 and 3 are divided.

**Frequency 3-4 [Hz]** [2.00k...16.00k]

Sets the frequency at which bands 3 and 4 are divided.

### ADJUST

**Knee** [Soft, 0.01...0.74, Hard]

This effectively controls both the onset/offset shape of the dynamics processing, and (in conjunction with **Range**), the compression/expansion ratio.

For more information, see “Range [dB],” below.

**Output Gain [dB]** [-18.0...+18.0]

Sets the overall output gain.

### Bands 1-4

Each of the four bands has identical parameters.

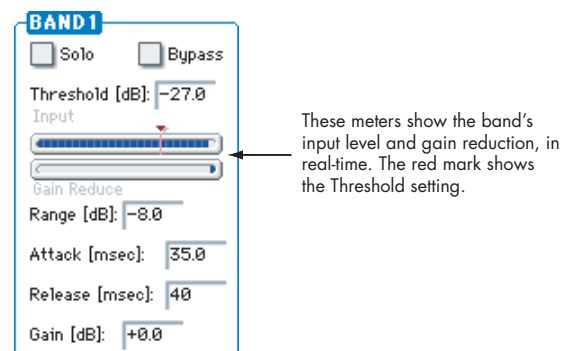

These meters show the band’s input level and gain reduction, in real-time. The red mark shows the Threshold setting.

**Solo** [Check-box]

Use this setting to audition the processed sound of each band.

If this is On, the output of other bands will be muted. If this is On for more than one band, only the bands for which this is On will be heard. Normally, this should be turned Off for all bands.

**Bypass** [Check-box]

You can bypass compression for each band individually.

When this is On, you’ll hear the band’s un-compressed signal.

**Threshold [dB]** [-80.0...0.0]

The compression/expansion functions only in a range around the **Threshold** level. Signals outside of this range are not affected.

For more information, see "Range [dB]," below.

**Range [dB]** [-24.0...+18.0]

The combination of **Threshold** and **Range** controls the band's basic functionality (traditional compressor, low-level expander, etc.), and the combination of **Range** and **Knee** creates the band's compression/expansion.

To create a traditional compressor action, set the **Threshold** around 0.0, and the **Range** to a negative value.

To create a low-level expander (raising lower volume levels, while leaving higher levels untouched), set the **Threshold** to a low level, and the **Range** to a positive value.

You can also create special compression effects, such as compressing (or expanding) only the middle range of levels. For more information, see the diagram below.

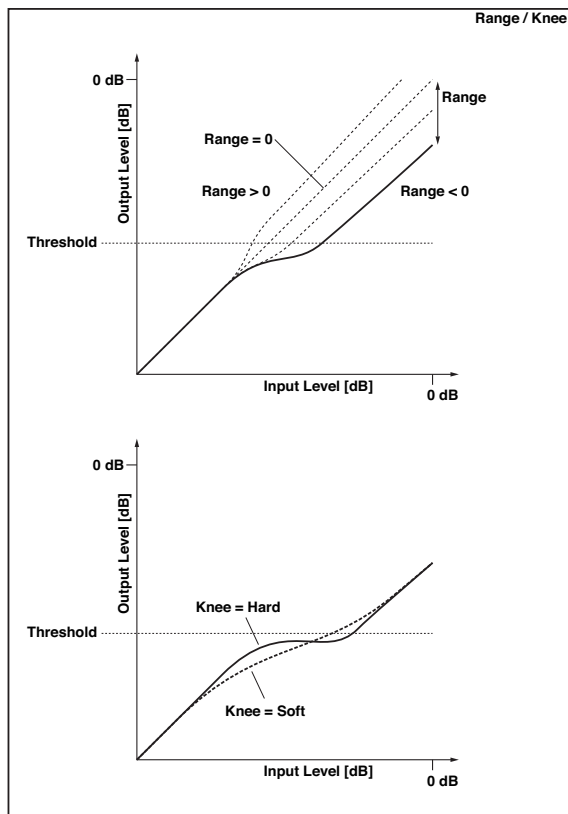

**Attack [msec]** [0.60...500.0]

Sets the band's attack time. For more information, see "Attack [msec]" on page 892.

**Release [msec]** [5...5000]

Sets the band's release time.

**Gain [dB]** [-18.0...+18.0]

Sets the band's output gain.

**OUTPUT**

This is the standard effects output section, with modulatable control over wet/dry balance. For more information, see "OUTPUT" on page 890.

# 005: Stereo Limiter

On-screen graphic, 005 Stereo Limiter

The yellow line shows the output level, relative to the input level. This will change according to the Ratio and Threshold settings. Input above the Threshold will be compressed. In the example shown here, a -10 dB input will result in -20 dB output.

This meter shows the amount of gain reduction, in real-time. To show that the gain is being reduced, the meter moves in the opposite direction from the Input meter.

This meter shows the output level, in real-time.

The red marks show the Threshold setting.

Vertical axis: Output from the limiter  
Horizontal axis: Input to the envelope control

This meter shows the control signal, in real-time, including the effect of the Side Chain EQ.

The red marks show the Threshold setting.

These lights show the relation of the control input to the Threshold, in real-time. Under (green) means the input is below the Threshold, and so the signal will pass through unchanged. Over (red) means that the input is above the Threshold, and so the signal will be limited.

The Limiter regulates the input signal level. It is similar to the Compressor, except that the Limiter compresses only signals that exceed the specified level to lower unnecessary peak signals. The Limiter applies a peaking-type EQ to the trigger signal (which controls the degree of the Limiter effect), allowing you to set any band width to be covered. This is a true stereo effect; you can link left and right channels, or use each channel individually.

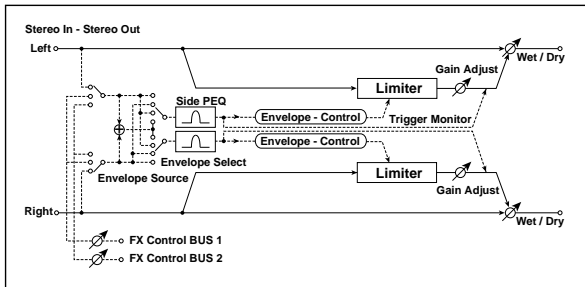

## ENVELOPE

**Source** [Input, FX Control 1, FX Control 2]

This selects the control signal for the limiter: the input signal, FX Control Bus 1, or FX Control Bus 2. For more information, see "Source" on page 891.

**Select** [L/R Mix, L Only, R Only, L/R Individually]

This determines how the left and right channels of the selected **Source** are used. Note that this parameter applies only to the control signal; the effect always processes both channels of the input signal in stereo. For more information, see "Select" on page 891.

**L/R Mix** is generally the best choice for stereo signals; this will cause the limiting to be applied equally to both channels, based on the combined volumes of the left and right channels.

**L Only** and **R Only** use only the selected channel for controlling the limiter; the other channel is ignored.

**L/R Individually** essentially splits the stereo limiter into two separately controlled mono limiters. When processing stereo signals, this will cause the stereo image to shift.

**FX Control Trim** [0...100]

This adjusts the level of the FX Control Bus inputs.

**Side Chain Monitor** [Check-box]

This lets you listen directly to the control signal (as selected by the **Source** parameter) through the sidechain EQ. See "Side Chain Monitor" on page 891.

## SIDE CHAIN EQ

This EQ applies only to the control signal, and not to the main audio path. Use it to alter the response of the limiter so that it reacts (or does not react) only to specific frequencies.

For instance, if you want the limiter to ignore cymbal crashes, adjust the sidechain EQ to reduce the gain of frequencies specific to the cymbals. While doing so, it may help to turn on the **Side Chain Monitor** switch, so that you can listen as you hone in on the desired frequencies.

**Side PEQ On** [Check-box]

This lets you enable and disable the sidechain EQ—handy for comparing its effect.

**Fc [Hz]** [20...12.00k]

Sets the EQ center frequency for the control signal.

**Q** [0.5...10.0]

Sets the EQ bandwidth for the control signal.

**Gain [dB]** [-18.0...+18.0]

Sets the EQ gain for the control signal.

**LIMITER**

**Ratio** [1.0:1...50.0:1, Inf:1]

Sets the signal compression ratio. For more information, see “Ratio” on page 891.

**Threshold [dB]** [-40...0]

Sets the level above which the compressor is applied. For more information, see “Threshold [dB]” on page 892.

**Attack** [1...100]

Sets the attack time. For more information, see “Attack [msec]” on page 892.

**Release** [1...100]

Sets the release time. For more information, see “Release [msec]” on page 892.

**Gain Adjust [dB]** [-Inf, -38...+24]

Sets the output gain. For more information, see “Gain Adjust [dB]” on page 892.

**Source** [Off...Tempo]

Selects the modulation source for the output gain.

**Amount** [-63...+63]

Sets the modulation amount of the output gain.

**OUTPUT**

This is the standard effects output section, with modulatable control over wet/dry balance. For more information, see “OUTPUT” on page 890.

**006: Multiband Limiter**

On-screen graphic, 006 Multiband Limiter

The yellow line shows the output level, relative to the input level. This will change according to the Ratio and Threshold settings.

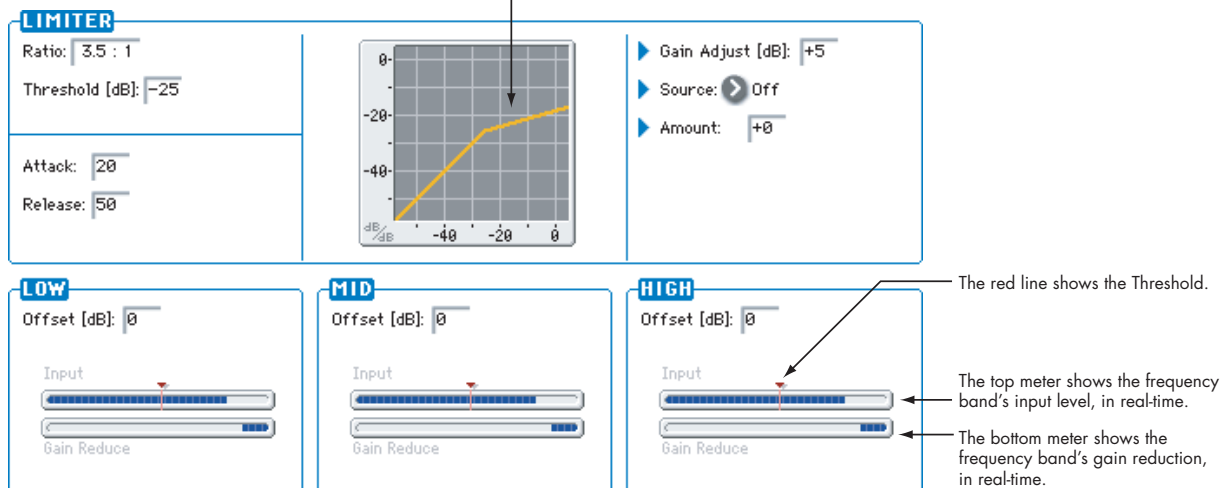

This mono effect provides separate limiters for the low, mid, and high frequencies. You can control the dynamics for each range to adjust the relative levels of the low, mid, and high ranges, with very different results from EQ.

**Threshold Offsets**

The three bands share common settings for ratio, attack and release times, and output gain adjust. The difference is in the threshold settings. In addition to the

overall **Threshold** parameter, each band has a threshold **Offset**, which makes the band more or less sensitive to the input signal.

For example, if you do not want to apply limiting to the high range, reduce the **High Offset** so that it is lower than the **Threshold**. This means that the high range limiter will not respond, and so the high band will pass through unaffected.

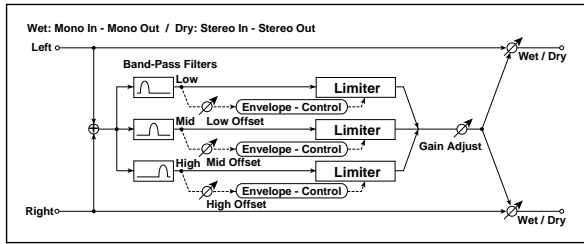

**LIMITER**

**Ratio** [1.0:1...50.0:1, Inf:1]

Sets the signal compression ratio. For more information, see "Ratio" on page 891.

**Threshold [dB]** [-40...0]

Sets the overall level above which the limiter is applied. Each band's Offset parameter then works as an offset for this parameter.

For more information, see "Threshold [dB]" on page 892.

**Attack** [1...100]

Sets the attack time. For more information, see "Attack [msec]" on page 892.

**Release** [1...100]

Sets the release time. For more information, see "Release [msec]" on page 892.

**Gain Adjust [dB]**  $D_{mod}$  [-Inf, -38...+24]

Sets the output gain. For more information, see "Gain Adjust [dB]" on page 892.

**Source** [Off...Tempo]

Selects the modulation source for the output gain.

**Amount** [-63...+63]

Sets the modulation amount of the output gain.

**LOW**

**Offset [dB]** [-40...0]

This adjusts the **Threshold** level for the low range.

**MID**

**Offset [dB]** [-40...0]

This adjusts the **Threshold** level for the mid range.

**HIGH**

**Offset [dB]** [-40...0]

This adjusts the **Threshold** level for the high range.

**OUTPUT**

This is the standard effects output section, with modulatable control over wet/dry balance. For more information, see "OUTPUT" on page 890.

**007: Stereo Multiband Limiter**

This is a true-stereo multiband limiter. For more information, see the mono version, "006: Multiband Limiter," above.

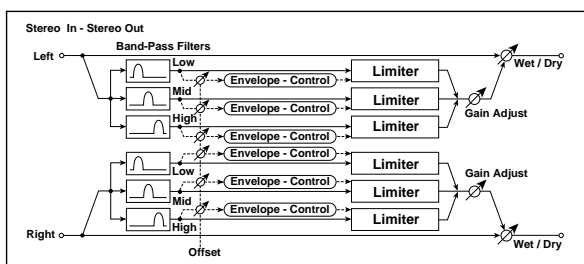

**LIMITER**

**Ratio** [1.0:1...50.0:1, Inf:1]

Sets the signal compression ratio. For more information, see "Ratio" on page 891.

**Threshold [dB]** [-40...0]

Sets the level above which the compressor is applied. For more information, see "Threshold [dB]" on page 892.

**Attack** [1...100]

Sets the attack time. For more information, see "Attack [msec]" on page 892.

**Release** [1...100]

Sets the release time. p.892.

**Gain Adjust [dB]**  $D_{mod}$  [-Inf, -38...+24]

Sets the output gain. p.892.

**Source** [Off...Tempo]

Selects the modulation source for the output gain.

**Amount** [-63...+63]

Sets the modulation amount of the output gain.

**LOW**

**Offset [dB]** [-40...0]

This adjusts the **Threshold** level for the low range. For more information, see "Threshold Offsets" on page 897.

**MID**

**Offset [dB]** [-40...0]

This adjusts the **Threshold** level for the mid range.

**HIGH****Offset [dB]** [-40...0]This adjusts the **Threshold** level for the high range.**OUTPUT**

This is the standard effects output section, with modulatable control over wet/dry balance. For more information, see "OUTPUT" on page 890.

**008: Stereo Mastering Limiter**

This stereo limiter is optimized for mastering full mixes. It uses a short look-ahead delay (1.3 ms) for zero-overshoot performance, and automatically optimizes the output level to a specified maximum.

For a description of the on-screen graphics, see "005: Stereo Limiter" on page 896.

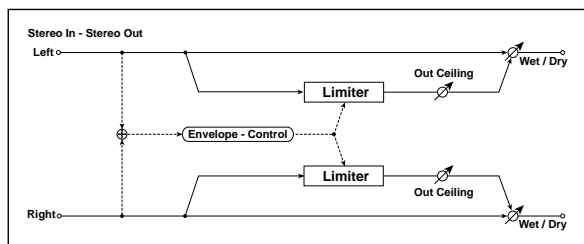
**LIMITER****Threshold [dB]** [-30.0...0.0]

This affects both the limiting threshold and the output gain.

Signals above the **Threshold** will be limited; signals below this level will not be limited, but will still benefit from any increase in output gain (see below).

The output gain is automatically increased by the difference between the **Threshold** and the **Out Ceiling**. For instance, if the **Threshold** is -9.0dB and the **Out Ceiling** is -3.0dB, gain will be increased by 6dB.

**Out Ceiling [dB]** [-30.0...0.0]

This controls the maximum output level. In general, it's best to set this slightly below 0.0, in order to accommodate the less-than-optimal output stages which are sometimes found in consumer audio devices.

An aggressive setting would be -0.3dB; a conservative setting, to avoid clipping on some older CD players, would be -3dB.

**Release [msec]** [0.65...1000.0]

This controls how long it takes the limiter to allow the gain to rise again after the signal is no longer above the threshold. Generally, settings between 1.0 and 5.0 milliseconds will be most effective. For more information, see "Release [msec]" on page 892.

**OUTPUT****Wet/Dry** [Dry, 1:99...99:1, Wet]

Sets the balance between the effect and the dry input.

**Important:** The look-ahead delay will cause phasing effects if this is set to any in-between values (1:99...99:1). Only completely **Wet** or **Dry** will sound correct.

**Source** [Off...Tempo]

Selects a modulation source for Wet/Dry.

**Amount** [+/-100]

Sets the modulation amount for Wet/Dry.

**Using the Stereo Mastering Limiter**

Careful compression and limiting are great mastering tools. Here are some simple instructions which should produce good results with most material:

1. Go to the TFX/MFX page.
2. For TFX2, select 008: Stereo Mastering Limiter  
The limiter should be the last effect before the output.
3. Set the **Out Ceiling** to a value between -0.3dB and -3dB.
4. Leave the **Release** at the default setting.
5. Make sure that **Wet/Dry** is set to **Wet**, with no modulation.
6. Go to the loudest part of the song.
7. While playing the song, adjust the **Threshold**, and watch the gain reduction meter. Set the **Threshold** so that the gain reduction meter rarely if ever shows more than 6dB of limiting.

You could also use a compressor in TFX1, before the limiter, such as 002: Stereo Compressor or 004: St. Multiband Compressor.

Above all, remember to be gentle; the more you increase the volume, the more likely you are to add distortion.

## 009: Stereo Gate

On-screen graphic, 009 Stereo Gate

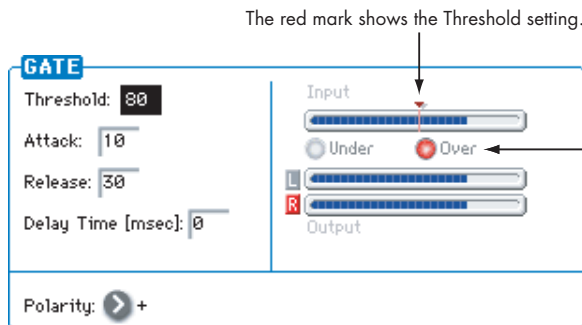

These lights show the relation of the control input to the Threshold, in real-time. Under (green) means the input is below the Threshold, and Over (red) means that it is above the Threshold. Going above the Threshold may make the gate open or close, depending on the Polarity setting.

This effect mutes the input signal when it falls below a specified level. You can also invert the on/off status of the gate, or use note-on/off messages to turn the gate on/off directly.

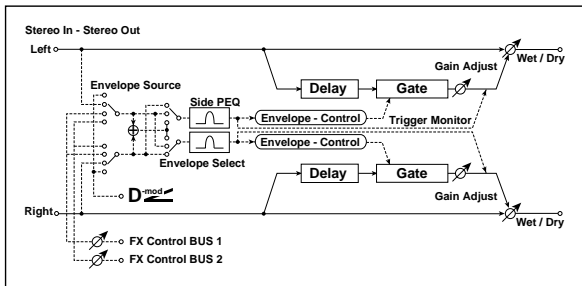

### GATE

**Threshold** [0...100]

Sets the level at which gating is applied.

Note that this does not apply when the ENVELOPE Source is set to Dmod.

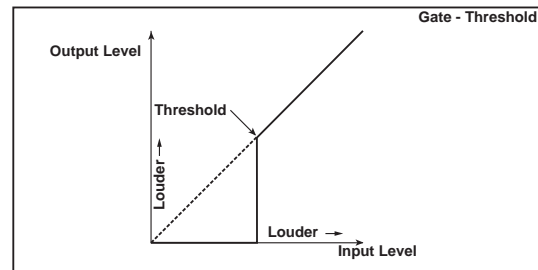

### ENVELOPE

**Source** [Dmod, Input, FX Control 1, FX Control 2]

Selects the source to control the gate: Dmod control, or use the input signal or FX Control Bus 1 or 2 as a trigger. See "Source" on page 891.

**Dmod Control**  $D_{mod}$  [Off...Tempo]

Selects the source that will control the gate when Envelope Source = Dmod.

**Select** [L/R Mix, L Only, R Only]

Selects the control signal: left and right linked, left only, or right only. See "Select" on page 891.

**Fx Control Trim** [0...100]

This adjusts the level of the FX Control Bus inputs.

**Side Chain Monitor** [Check-box]

Switches between monitoring the effect output and the trigger signal. For more information, see "Side Chain Monitor" on page 896.

**Attack** [1...100]

Sets the attack time.

**Release** [1...100]

Sets the release time.

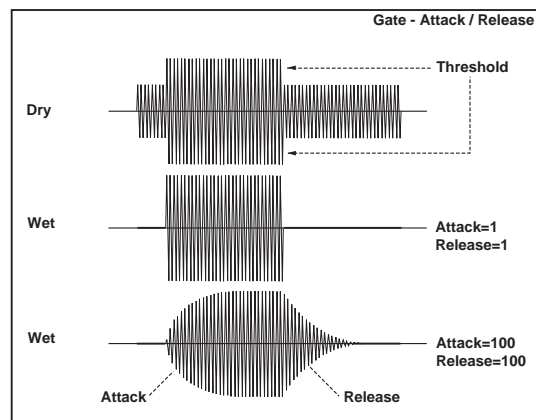

### SIDE CHAIN EQ

This band of fully parametric EQ applies only to the control signal, and not to the main audio path. Use it to alter the response of the limiter so that it reacts (or does not react) only to specific frequencies. Its parameters are identical to those in the Stereo Limiter; for more information, see "SIDE CHAIN EQ" on page 896.

**Delay Time [msec]** [0...100]

This sets the delay time for the input to the gate. When using shorter Attack Time settings, you can lengthen the Delay Time so that the sound is input after the gate opens.



**Polarity** [+ , -]

This controls the way that the gate opens and closes in response to the input signal.

+: This is the default setting, for normal gate behavior. The gate will open when the input is above the Threshold, and close when the input falls below it.

-: This reverses the normal operation. The gate will *close* when the input is above the Threshold, and *open* when the input falls below it.

With -, the direction in which the modulation source opens or closes the gate is reversed as well.

**OUTPUT**

This is the standard effects output section, with modulatable control over wet/dry balance. For more information, see "OUTPUT" on page 890.

**010: Stereo Noise Reduction**

This effect minimizes obtrusive noise by reducing the volume when the signal is at a low level. You can use this if a guitar or mic signal from the audio input contains noise.

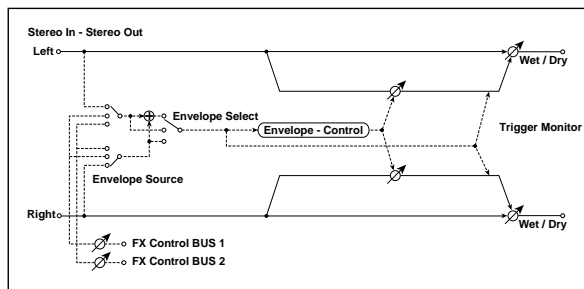

On-screen graphic, 010 Stereo Noise Reduction

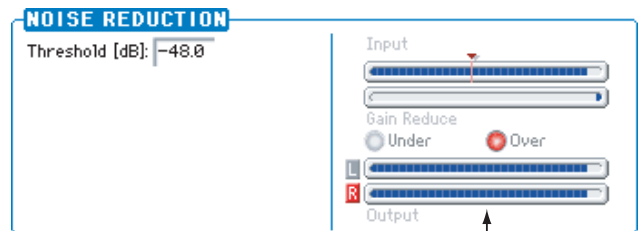

This is a realtime indication of the control input signal level (Input), the gain reduction produced by the control input signal (Gain Reduce), and the output signal level (Output). Noise Reduction reduces the noise level below the Threshold.

**ENVELOPE**

**Envelope Source** [Input, FX Control 1, FX Control 2]

Selects the trigger source to use: the input signal, FX Control Bus 1, or FX Control Bus 2. p.891.

**Envelope Select** [L/R Mix, Left, Right]

Selects whether the compressor is linked between left/right, controlled only by the left signal, only by the right signal, or independently for left and right. p.891.

**Fx Control Trim** [0...100]

This adjusts the level of the FX Control Bus inputs.

**NOISE REDUCTION**

**Trigger Monitor** [Check-box]

Switches between monitoring the effect output and the trigger signal. p.896.

**Threshold [dB]** [-72.0...-22.0]

Sets the noise level

**OUTPUT**

This is the standard effects output section, with modulatable control over wet/dry balance. For more information, see "OUTPUT" on page 890.

## EQ and Filters

### 011: Stereo Parametric 4EQ

On-screen graphic, 011 Stereo Parametric 4EQ

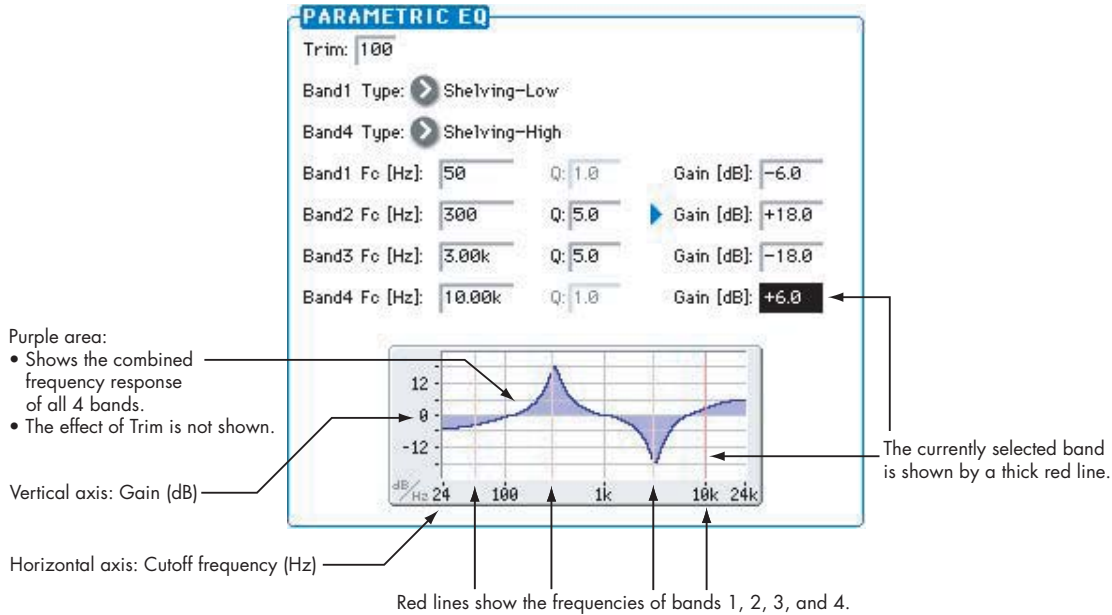

This is a stereo 4-band parametric equalizer. Bands 1 and 4 can be set to either peaking or shelving modes, and you can modulate the gain of Band 2 in real-time.

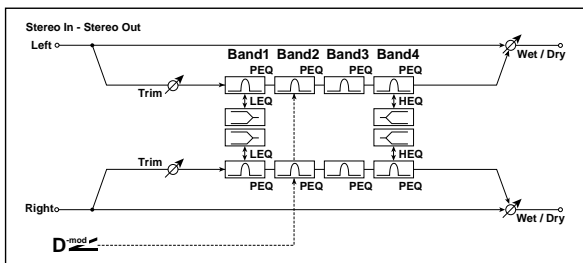

#### PARAMETRIC EQ

**Trim** [0...100]

Sets the input level.

**Band1 Type** [Peaking, Shelving-Low]

**Peaking** creates a bell shape around a center frequency.

**Shelving** creates a slope up to a "shelf," which then extends all the way to the bottom or top of the frequency range.

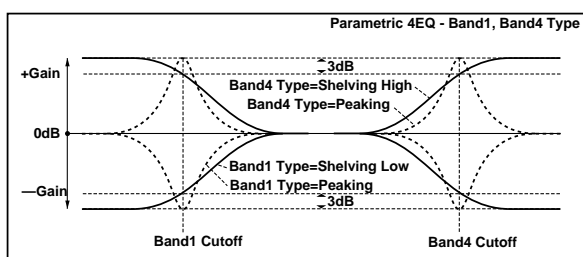

**Band4 Type** [Peaking, Shelving-High]

Selects the EQ type for Band 4. See "Band1 Type," above.

**Band1 Fc [Hz]** [20...1.00k]

Sets the center frequency of Band 1.

**Q** [0.5...10.0]

Sets the bandwidth of Band 1. The higher the value, the narrower the band becomes.

**Gain [dB]** [-18.0...+18.0]

Sets the gain of Band 1.

**Band2 Fc [Hz]** [50...10.00k]

Sets the center frequency of Band 2.

**Q** [0.5...10.0]

Sets the bandwidth of Band 2.

**Gain [dB]** [-18.0...+18.0]

Sets the gain of Band 2.

**Band3 Fc [Hz]** [300...10.00k]

Sets the center frequency of Band 3.

**Q** [0.5...10.0]

Sets the bandwidth of Band 3.

**Gain [dB]** [-18.0...+18.0]

Sets the gain of Band 3.

**Band4 Fc [Hz]** [500...20.00k]

Sets the center frequency of Band 4.

**Q** [0.5...10.0]  
Sets the bandwidth of Band 4.

**Gain [dB]** [-18.0...+18.0]  
Sets the gain of Band 4.

**Band2 Source** [Off...Tempo]  
Selects the modulation source for the Band 2 gain.

**Amount [dB]** [-18.0...+18.0]  
Sets the modulation amount for the Band 2 gain.

**GAIN MOD**

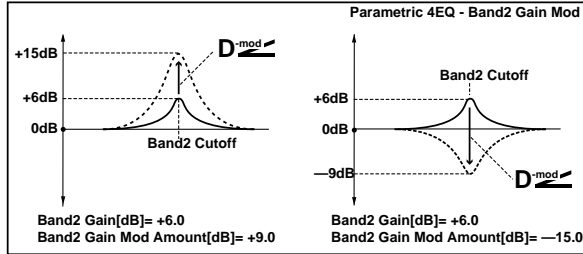

**OUTPUT**

This is the standard effects output section, with modulatable control over wet/dry balance. For more information, see "OUTPUT" on page 890.

**012: Stereo Graphic 7EQ**

On-screen graphic, 012: Stereo Graphic 7EQ

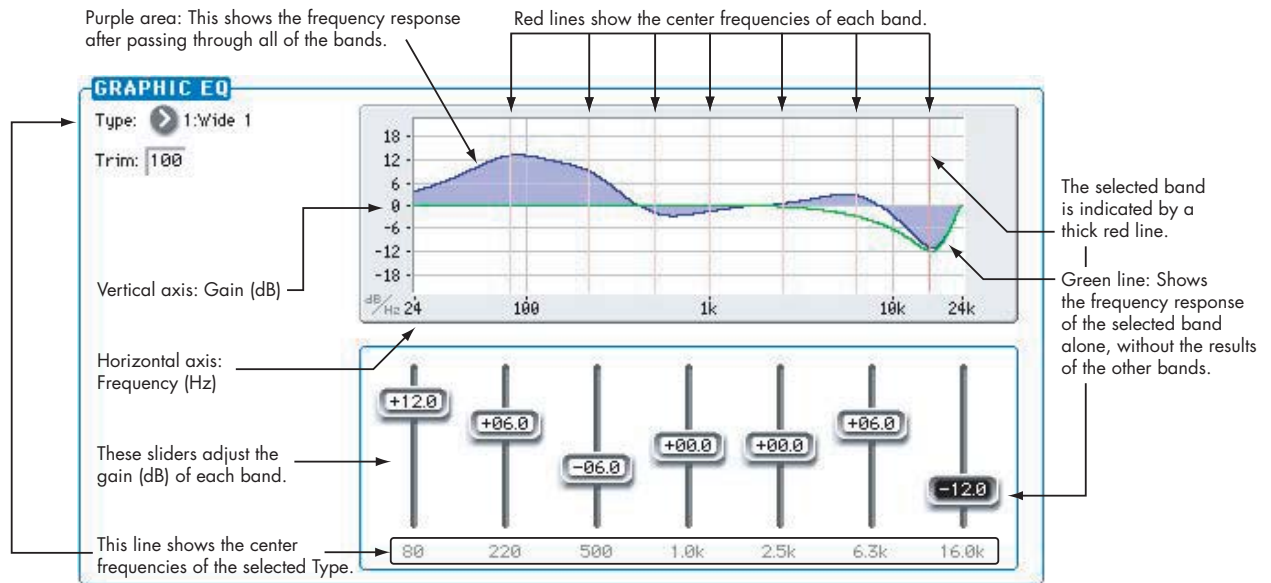

This is a stereo 7-band graphic equalizer. The bar graph of the gain setting for each band gives you a clear, visual idea of frequency responses. You can select a center frequency setting for each band from twelve types, according to the sound.

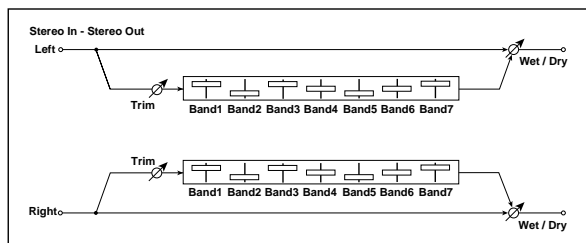

**GRAPHIC EQ**

**Type** [1:Wide 1, 2:Wide 2, 3:Wide 3, 4:Half Wide 1, 5:Half Wide 2, 6:Half Wide 3, 7:Low, 8:Wide Low, 9:Mid, 10:Wide Mid, 11:High, 12:Wide High]

This parameter selects a combination of center frequencies for each band. Each center frequency is shown on the bottom of the Gain slider.

You can configure a 21-Band Graphic EQ ranging from 80Hz to 18kHz if you route three Graphic 7Band EQ effects in series, with a setting of 7:Low, 9:Mid, and 11:High for each EQ.

**Trim** [0...100]

Sets the input level

**(Band1...8 Gain [dB])** [-18.0...+18.0]

These controls set the gain for each of the eight bands.

## OUTPUT

This is the standard effects output section, with modulatable control over wet/dry balance. For more information, see “OUTPUT” on page 890.

## 013: Stereo Master 3EQ

This is a stereo three-band equalizer, with sweepable low and high shelving and a fully parametric mid-band. The low and high gains can be controlled in real-time. You can use this as a TFX to make final adjustments to the sound.

For a description of the on-screen EQ graphic, see “011: Stereo Parametric 4EQ” on page 902.

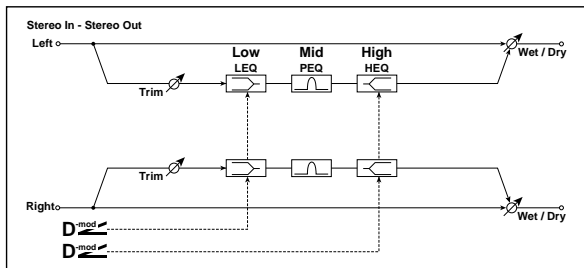

## PARAMETRIC EQ

**Trim** [0...100]

Sets the input level.

**Low Fc [Hz]** [0...980]

Sets the cutoff frequency of the Low EQ (shelving type).

**Gain [dB]**  $D_{mod} \leq$  [-18.0...+18.0]

Sets the gain of the Low EQ.

**Mid Cutoff [Hz]** [100...10.00k]

Sets the cutoff frequency of the Mid EQ (peaking type).

**Q** [0.5...10.0]

Sets the bandwidth of the Mid EQ

**Gain [dB]** [-18.0...+18.0]

Sets the gain of the Mid EQ.

**High Cutoff [Hz]** [500...20.00k]

Sets the cutoff frequency of the High EQ (shelving type).

**Gain [dB]**  $D_{mod} \leq$  [-18.0...+18.0]

Sets the gain of the High EQ.

## GAIN MOD

**Low Source** [Off...Tempo]

Selects the source that will modulate the Low Gain.

**Amount [dB]** [-36.5...+36.0]

Sets the amount by which the Low Gain will be modulated.

**High Source** [Off...Tempo]

Selects the source that will modulate the High Gain.

**Amount [dB]** [-36.5...+36.0]

Sets the amount by which the High Gain will be modulated.

## OUTPUT

This is the standard effects output section, with modulatable control over wet/dry balance. For more information, see “OUTPUT” on page 890.

## 014: Stereo Exciter/Enhncr

This effect is a combination of the Exciter, which adds a punch to the sound and the Enhancer, which adds spread and presence.

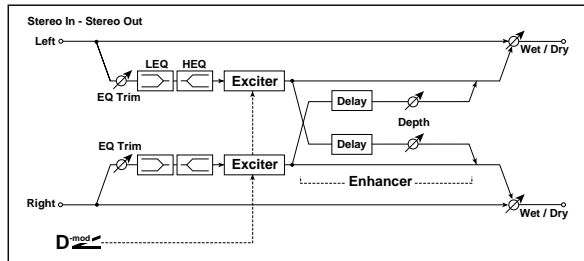

### Pre EQ

**Trim** [0...100]

Sets the 2-band EQ input level.

**LEQ Fc** [Low, Mid-Low]

Selects the cutoff frequency (low or mid-low) of the low-range equalizer.

**LEQ Gain [dB]** [-15.0...+15.0]

Sets the gain of the Low EQ.

**HEQ Fc** [High, Mid-High]

Selects the cutoff frequency (high or mid-high) of the high-range equalizer.

**HEQ Gain [dB]** [-15.0...+15.0]

Sets the gain of the High EQ.

### EXCITER

**Emphasis Frequency** [0...70]

This parameter sets the frequency to be emphasized. Higher values will emphasize lower frequencies.

**Source** [Off...Tempo]

Selects the modulation source for the Emphasis Frequency.

**Amount** [-70...+70]

Sets the amount of modulation of the frequency to be emphasized

**Blend** [+/-100]

This parameter sets the depth (intensity) of the Exciter effect. Positive values give a frequency pattern (to be emphasized) different from negative values.

**Source** [Off...Tempo]

Selects the modulation source for the Exciter intensity.

**Amount** [+/-100]

Sets the modulation amount for the Exciter intensity.

### ENHANCER

**L Delay Time [msec]** [0.0...50.0]

The L and R Delay Time parameters set the delay times for the Enhancer's left and right channels. Specifying slightly different delay times for the left and right channels will add a stereo image, depth, and width to the sound.

**R Delay Time [msec]** [0.0...50.0]

Sets the delay time for the Enhancer's right channel. For more information, see "L Delay Time [msec]," above.

**Depth** [0...100]

Sets the determines to what degree the Enhancer effect is applied.

**Source** [Off...Tempo]

Selects the modulation source of the Enhancer width.

**Amount** [+/-100]

Sets the modulation amount of the Enhancer width.

### OUTPUT

This is the standard effects output section, with modulatable control over wet/dry balance. For more information, see "OUTPUT" on page 890.

## 015: Stereo Isolator

This is a stereo effect that separates the input signal into low, mid, and high-frequency bands, and controls the volume of each band independently. For example you can separately boost or cut the kick, snare, and hi-hat sounds from a drum signal in realtime.

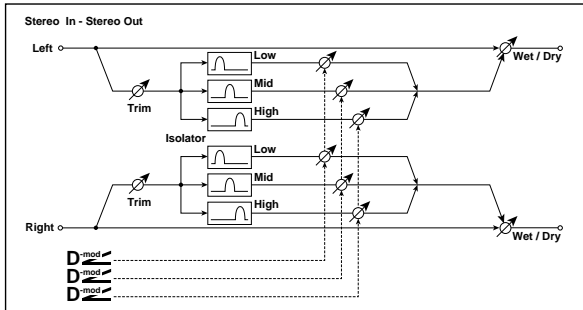

### XOVER FILTER

For a description of the on-screen Crossover Filter graphic, see "004: St.Multiband Compressor" on page 894.

**Trim** [0...100]

Sets the input level.

**Frequency Low-Mid [Hz]** [100...500]

Sets the frequency at which the low and mid bands are divided.

**Frequency Mid-High [Hz]** [2000...6000]

Sets the frequency at which the mid and high bands are divided.

### ISOLATOR

**Low Gain [dB]** [-Inf, -59...+12]

Sets the low-frequency gain.

**Source** [Off...Tempo]

Selects the source that will modulate low-frequency gain.

**Amount** [-72...+72]

Sets the amount by which the low-frequency gain will be modulated.

**Mid Gain [dB]** [-Inf, -59...+12]

Sets the mid-frequency gain.

**Source** [Off...Tempo]

Selects the modulation source for mid-frequency gain.

**Amount** [-72...+72]

Sets the amount by which the mid-frequency gain will be modulated.

**High Gain [dB]** [-Inf, -59...+12]

Sets the high-frequency gain.

**Source** [Off...Tempo]

Selects the modulation source for high-frequency gain.

**Amount** [-72...+72]

Sets the amount by which the high-frequency gain will be modulated.

### OUTPUT

This is the standard effects output section, with modulatable control over wet/dry balance. For more information, see "OUTPUT" on page 890.

## 016: Stereo Wah/Auto Wah

This stereo wah effect allows you to create sounds from vintage wah pedal simulation to auto-wah simulation, and much broader range settings.

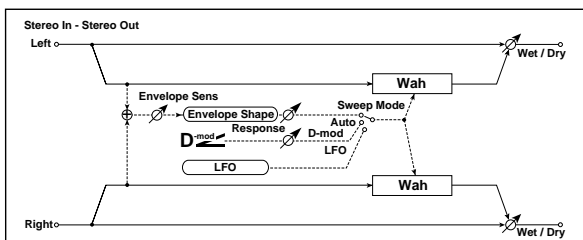

### CONTROL

**Sweep Mode** [Auto, Dmod, LFO]

This parameter selects how the wah will be controlled.

**Auto** makes the sweeps follow the input signal's volume envelope. Auto-wah is frequently used for funk guitar parts and clav sounds.

**Dmod** lets you control the filter directly via a modulation source, just like a wah pedal.

**LFO** uses an LFO to create cyclic sweeps.

**Source** [Off...Tempo]

Selects the modulation source for the wah when **Sweep Mode** is set to **Dmod**.

**Response** [0...100]

Sets the response speed when **Sweep Mode** is set to **Auto** or **Dmod**.

**Envelope Sens** [0...100]

This parameter sets the sensitivity of auto-wah. Increase the value if the input signal is too low to sweep. Reduce the value if the input signal is so high that the filter is stopped temporarily.

**Envelope Shape**

[+/-100]

This parameter determines the sweep curve for the auto-wah.

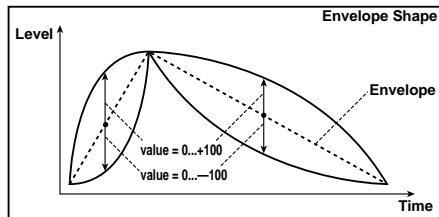
**LFO****Frequency****Frequency [Hz]** [0.02...20.00]

This sets the LFO speed, in Hz. It applies only when MIDI/Tempo Sync, below, is Off.

**Source** [Off...Tempo]

This selects a modulation source for the Frequency.

**Amount** [-20.00...+20.00]

This sets the Frequency modulation amount, in Hz.

**MIDI/Tempo Sync****MIDI/Tempo Sync** [Check-box]

**On (checked):** When MIDI/Tempo Sync is On, the LFO will synchronize to tempo as set by BPM, below. The LFO speed will be controlled by the Base Note and Times parameters, below. All settings for Frequency and Frequency Source and Amount will be ignored.

**Off (unchecked):** When MIDI/Tempo Sync is Off, the Frequency settings will determine the speed of the LFO, and the BPM, Base Note, and Times settings will have no effect.

**BPM** [MIDI, 40.00...300.00]

MIDI syncs to the system tempo. 40-240 sets the tempo manually for this individual effect.

**Base Note** [...]

This sets the basic speed of the LFO, relative to the BPM setting. The values range from a 32nd note to a whole note, including triplets.

**Times** [x1...x32]

This multiplies the length of the Base Note. For instance, if the Base Note is set to a sixteenth note, and Times is set to 3, the LFO will cycle over a dotted eighth note.

**LFO Type****Type** [Individual, Common1, Common2]

**Individual:** the LFO uses the Frequency and MIDI/Tempo Sync parameters, above.

**Common 1 or 2:** the LFO uses the frequency or tempo sync of the selected Common LFO, so that you can synchronize multiple LFO-based effects together.

For more information, see "Common FX LFOs" on page 860.

**Common LFO Phase Offset [degrees]** [+/-180]

This specifies the phase difference relative to the selected Common FX LFO. It applies only when Type is set to Common 1 or Common 2.

**WAH****Frequency Bottom** [0...100]

This sets the wah frequency when the modulation signal (selected by Sweep Mode) is at its minimum level.

To reverse the sweep direction, you can set this to be higher than the Frequency Top, below.

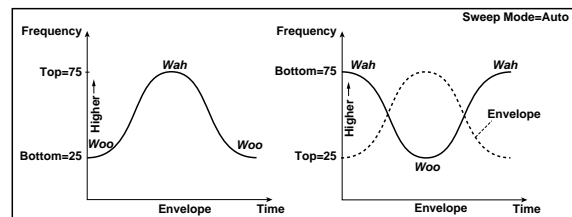
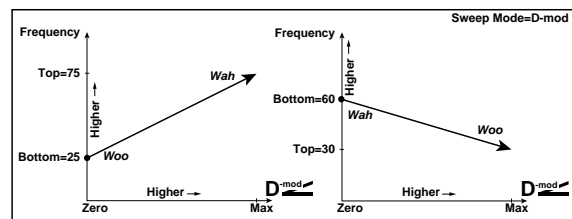
**Frequency Top** [0...100]

This sets the wah frequency when the modulation signal (selected by Sweep Mode) is at its maximum level.

**Resonance** [0...100]

Sets the resonance amount.

**Low Pass Filter** [Check-box]

Switches the wah low pass filter on and off.

**Output Level** [0...100]

Sets the output level of the effect sound.

**Source** [Off...Tempo]

Selects the modulation source that will control the effect output level.

**Amount** [+/-100]

Sets the modulation amount of the effect output level.

**OUTPUT**

This is the standard effects output section, with modulatable control over wet/dry balance. For more information, see "OUTPUT" on page 890.



## 017: St. Vintage/Custom Wah

This effect models the tonal character of a vintage wah pedal. You can customize the tone and range settings.

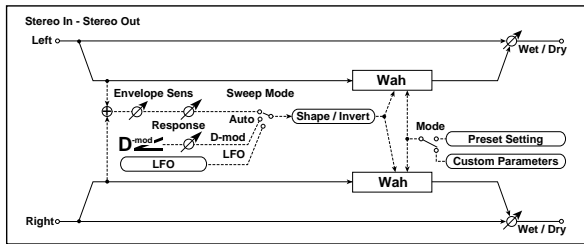

### CONTROL

**Sweep Mode** [Auto, Dmod, LFO]

Selects the control from auto-wah, modulation source, and LFO. For more information, see “Sweep Mode” on page 906.

**Source** [Off...Tempo]

Selects the modulation source for the wah when **Sweep Mode** is set to **Dmod**.

**Manual** [0...100]

Sets the center frequency when **Sweep Mode** is set to **Dmod** and **Source** is set to **Off**.

**Response** [0...100]

Sets the speed of response when **Sweep Mode** is set to **Auto** or **Dmod**.

**Envelope Sens** [0...100]

Sets the auto-wah sensitivity.

### LFO

**Frequency [Hz]** [0.02...20.00]

This sets the LFO speed, in Hz. It applies only when **MIDI/Tempo Sync**, below, is **Off**.

**Source** [Off...Tempo]

This selects a modulation source for the **Frequency**.

**Amount** [-20.00...+20.00]

This sets the **Frequency** modulation amount, in Hz.

**MIDI/Tempo Sync** [Check-box]

**BPM** [MIDI, 40.00...300.00]

**Base Note** [♪...♩]

**Times** [x1...x32]

When **MIDI/Tempo Sync** is **On**, the LFO speed is set by **BPM**, **Base Note**, and **Times**, instead of **Frequency**. For more information, see “MIDI/Tempo Sync” on page 907.

**Type** [Individual, Common1, Common2]

This controls whether the effect uses its individual LFO, or one of the Common FX LFOs. For more information, see “LFO Type” on page 907.

**Common LFO Phase Offset [degrees]** [+/-180]

When **Type** is set to **Common FX LFO 1** or **2**, this lets you offset the phase from the master LFO.

### WAH

**Mode** [Preset, Custom]

Selects either preset or custom settings.

**Frequency Bottom** [0...100]

Sets the lower limit of the wah center frequency when **Mode** is set to **Custom**. p.907.

**Frequency Top** [0...100]

Sets the upper limit of the wah center frequency when **Mode** is set to **Custom**. p.907.

**Resonance Bottom** [0...100]

Sets the lower limit of resonance amount when **Mode** is set to **Custom**.

**Resonance Top** [0...100]

Sets the upper limit of resonance amount when **Mode** is set to **Custom**.

**Shape** [+/-100]

This parameter specifies the sweep curve of the wah. It applies to all control via auto-wah, Dmod, and LFO, and lets you adjust subtle nuances of the wah effect.

**Invert** [Check-box]

Inverts the polarity of the sweep.

**Output Level** [0...100]

Sets the output level of the effect sound.

**Source** [Off...Tempo]

Selects the modulation source that will control the effect output level.

**Amount** [+/-100]

Sets the modulation amount of the effect output level.

### OUTPUT

This is the standard effects output section, with modulatable control over wet/dry balance. For more information, see “OUTPUT” on page 890.

## 018: Stereo Random Filter

This stereo band pass filter is modulated by an LFO, using either a step-shape waveform and or a sample-and-hold shape. The filter will also self-resonate, for creating special effects.

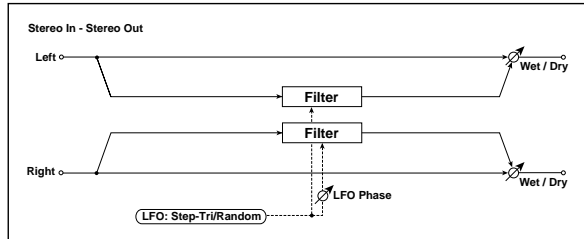

### FILTER

**Manual** [0...100]

Sets the filter's center frequency, before LFO modulation.

**Depth**  $D_{mod}$  [0...100]

The LFO modulates the filter's frequency; this sets the intensity of the LFO modulation.

**Source** [Off...Tempo]

Selects a source to modulate the LFO Depth.

**Amount** [+/-100]

Sets the intensity of the Depth modulation.

**Resonance** [0...100]

Resonance emphasizes the audio around the filter's center frequency.

At 0, there is no emphasis, and frequencies outside the center will simply diminish smoothly.

At medium settings, the resonance will alter the timbre of the filter, making it sound more nasal or extreme.

At very high settings, the resonance can be heard as a separate, whistling pitch. At 100, the filter will self-oscillate (after being fed an initial burst of input).

### LFO

#### Waveform and Phase

**Waveform** [Step-Tri, Random]

**Step-Tri** creates a steppy triangle waveform (see the diagram below). The **LFO Frequency** parameter sets the original triangle waveform speed, and the **LFO Step Freq** parameter adjusts the width of the steps.

**Random** produces a sample-and-hold waveform, with the speed controlled by the **Step Freq**.

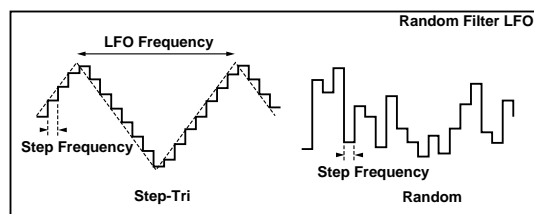

**Phase [degrees]** [-18...+18]

This sets the LFO phase difference between the left and right, in steps of 10 degrees. Offsetting the left and right phases alters how modulation is applied to the left and right channels, creating a swelling effect.

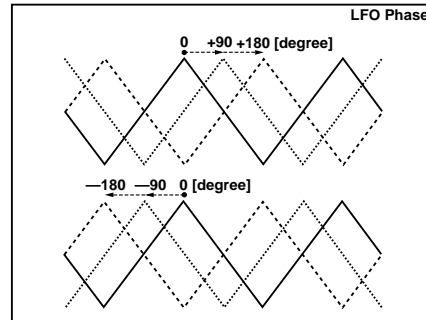

#### Frequency

These parameters apply when **MIDI/Tempo Sync** is Off (un-checked).

**Frequency [Hz]**  $D_{mod}$  [0.02...20.00]

This sets the speed of the triangle waveform, in Hz.

**Step Frequency [Hz]**  $D_{mod}$  [0.05...50.00]

This sets the speed of the steps, in Hz.

**Source** [Off...Tempo]

This selects a modulation source for both the **Frequency** and the **Step Frequency**. You can set the modulation amounts individually, below.

**Amount** [-20.00...+20.00]

Sets the **Frequency** modulation amount, in Hz.

**Step Amount** [-50.00...+50.00]

Sets the **Step Frequency** modulation amount, in Hz.

#### MIDI/Tempo Sync

**MIDI/Tempo Sync**  $\text{MIDI}$  [Check-box]

When this is on, the LFO speed is set by **BPM**, **Base Note**, and **Times**, instead of **Frequency**. For more information, see "MIDI/Tempo Sync" on page 907.

**BPM** [MIDI, 40.00...300.00]

MIDI syncs to the system tempo. 40-240 sets the tempo manually for this individual effect.

**Base Note** [♩...♩]

**Times** [x1...x32]

These set triangle waveform's base note and multiplier. For more information, see "MIDI/Tempo Sync" on page 907.

**Step Note**  $\text{MIDI}$  [♩...♩]

**Times** [x1...x32]

These set the step's base note and multiplier. For more information, see "MIDI/Tempo Sync" on page 907.

### Step LFO type

**Type (Step)** [Individual, Common1, Common2]

This controls the LFO source for the steps. It does not affect the triangle LFO.

**Individual:** the steps use the Frequency and MIDI/Tempo Sync parameters, above.

**Common 1 or 2:** the steps use the frequency or tempo sync of the selected Common LFO, so that you can synchronize multiple LFO-based effects together.

**Common LFO Phase Offset [degrees]** [+/-180]

Sets the phase offset when Type = Common 1 or Common 2. p.907.

## 019: Multi Mode Filter

This multi-mode filter includes low pass, high pass, band pass, and band reject modes. You can modulate the cutoff frequency and resonance from either an LFO or dynamic modulation.

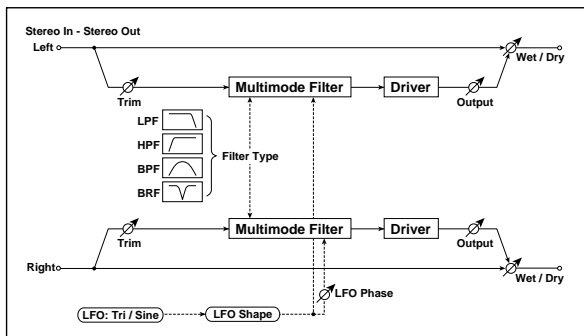

### MULTIMODE FILTER

**Trim** [0...100]

Sets the input level.

**Type** [LPF, HPF, BPF, BRF]

Selects the type of filter. For more information, see "Filter Type" on page 70.

**Cutoff Frequency**  $D_{mod}$  [0...100]

Sets the cutoff frequency (center frequency).

**Source** [Off...Tempo]

Selects the modulation source of the cutoff.

**Amount** [+/-100]

Sets the modulation amount of the cutoff.

**Depth** [0...100]

Sets the depth to which the LFO will modulate the cutoff frequency.

**Resonance**  $D_{mod}$  [0...100]

Sets the resonance amount.

**Source** [Off...Tempo]

Selects the source that will modulate the amount of resonance.

### OUTPUT

**Wet/Dry**  $D_{mod}$  [-Wet, -99:1...-1:99, Dry, 1:99...99:1, Wet]

This sets the balance between the effect and the dry input. From -Wet to -1:99, the effect sound's phase will be reversed.

**Source** [Off...Tempo]

This selects a modulation source for Wet/Dry.

**Amount** [+/-100]

This sets the modulation amount for Wet/Dry.

**Amount** [+/-100]

Sets the amount by which the resonance will be modulated.

### DRIVER

**Bypass** [Check-box]

Switches distortion on/off within the filter.

**Gain** [0...100]

Sets the distortion amount.

**Low Boost** [0...100]

Sets the amount of low-range boost.

**Output** [0...100]

Sets the output level.

### LFO

**Waveform** [Triangle, Sine]

Selects the LFO Waveform.

**Shape** [+/-100]

This changes the curvature of the LFO Waveform, which emphasizes or de-emphasizes the peaks, as shown below.

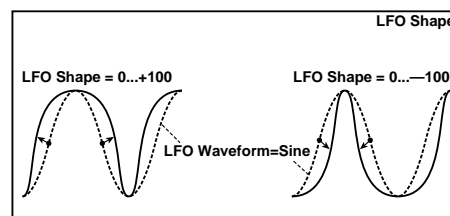

**Phase [degrees]** [-180...+180]

Sets the LFO phase difference between the left and right. See "Phase [degrees]" on page 909.

**Frequency [Hz]**  $D_{mod}$  [0.02...20.00]

This sets the LFO speed, in Hz. It applies only when MIDI/Tempo Sync, below, is Off.

**Source** [Off...Tempo]This selects a modulation source for the **Frequency**.**Amount** [-20.00...+20.00]This sets the **Frequency** modulation amount, in Hz.**MIDI/Tempo Sync**  [Check-box]**BPM** [MIDI, 40.00...300.00]**Base Note** [♪...♭]**Times** [x1...x32]When **MIDI/Tempo Sync** is on, the LFO speed is set by **BPM**, **Base Note**, and **Times**, instead of **Frequency**. For more information, see “MIDI/Tempo Sync” on page 907.**Type** [Individual, Common1, Common2]

This controls whether the effect uses its individual LFO, or one of the Common FX LFOs. For more information, see “LFO Type” on page 907.

**Common LFO Phase Offset [degrees]** [+/–180]When **Type** is set to **Common FX LFO 1** or **2**, this lets you offset the phase from the master LFO.

## OUTPUT

This is the standard effects output section, with modulatable control over wet/dry balance. For more information, see “OUTPUT” on page 890.

## 020: Stereo Sub Oscillator

This effect adds very low frequencies to the input signal. It's useful for creating powerful sub-bass effects, such as deep, rumbling drum sounds. You can also adjust the oscillator frequency to follow incoming MIDI notes, for use as an octaver.

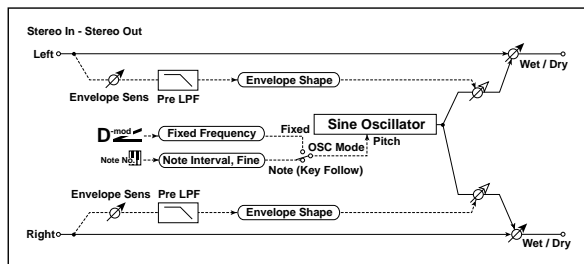

### ENVELOPE

**Pre LPF** [1...100]

This parameter sets the upper limit of the frequency range to which very low harmonics are added. Adjust this parameter if you do not want to add lower harmonics to the higher range.

**Sensitivity** [0...100]

Sets the sensitivity with which very low harmonics are added.

**Shape** [+/–100]

Sets the oscillator's volume envelope curve.

### SUB OSCILLATOR

**OSC Mode** [Note (Key Follow), Fixed]

This determines whether the oscillator frequency follows the note number, or stays at a fixed value.

**Note (Key Follow)**: The oscillator's frequency is based on MIDI note number (on the effect's MIDI channel), allowing you to use it as an octaver. The **Note Interval** parameter, below, sets the pitch offset from the original note, in semitones.**Fixed**: the oscillator uses the manually-set **Fixed Frequency**, below.**Note Interval** [–48...0]This sets a pitch offset from the received MIDI note number, in semitones. It applies only when **OSC Mode** is set to **Note (Key Follow)**.**Note Fine** [+/–100]This adjusts the frequency in cents (1/100 of a semitone). It applies only when **OSC Mode** is set to **Note (Key Follow)**.**Fixed Frequency [Hz]**  [10.0...80.0]Sets the oscillator frequency when **OSC Mode** is set to **Fixed**.**Source** [Off...Tempo]Selects the modulation source for the oscillator frequency when **OSC Mode** is set to **Fixed**.**Amount** [–80...+80]Sets the oscillator frequency modulation amount when **OSC Mode** is set to **Fixed**.

## OUTPUT

This is the standard effects output section, with modulatable control over wet/dry balance. For more information, see “OUTPUT” on page 890.

## 021: Talking Modulator

This effect adds an unusual character, like a human voice, to the input signal. Modulating the tone via dynamic modulation, you can create an interesting effect that sounds as if the guitar or synthesizer is talking.

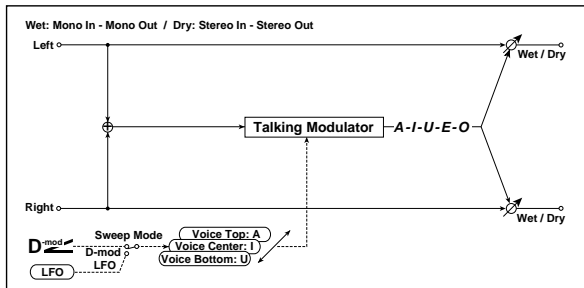

### CONTROL

**Sweep Mode** [Dmod, LFO]

Switches between modulation source control and LFO control.

**Source** [Off...Tempo]

Selects the modulation source that controls the voice pattern.

**Manual Voice Control** [Bottom, 1...49, Center, 51...99, Top]

Voice pattern control.

### TALKING MODULATOR

The **Voice Top**, **Center**, and **Bottom** parameters assign vowels to the top, center, and bottom positions of the Dmod controller or LFO.

For instance, when **Voice Top** is set to **A**, **Voice Center** is set to **I**, and **Voice Bottom** is set to **U**:

If **Sweep Mode** is set to **Dmod** and **Ribbon** is selected as the modulation **Source**, moving your finger from the right to left of the ribbon controller will change the sound from “a” to “i,” then “u.”

If **Sweep Mode** is set to **LFO**, the sound will change cyclically from “a” to “i,” “u,” “i,” then “a.”

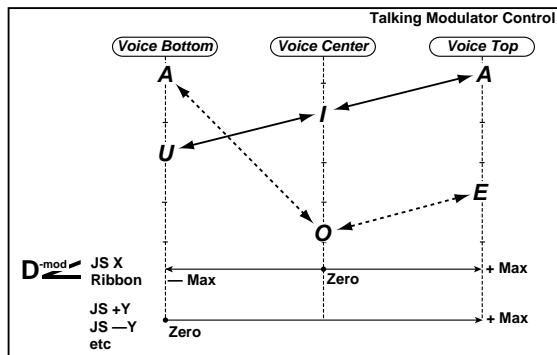

**Voice Top** [A, I, U, E, O]

Selects a vowel sound at the maximum modulation value.

**Voice Center** [A, I, U, E, O]

Selects a vowel sound at the center modulation value.

**Voice Bottom** [A, I, U, E, O]

Selects a vowel sound at the minimum modulation value.

**Formant Shift** [+/-100]

Sets the frequency to which the effect is applied.

This parameter adjusts the frequency level to which the effect is applied. If you wish to apply the effect to a higher-range sound, set this parameter to a higher value; to apply the effect to a lower-range sound, set this to a lower value.

**Resonance** [0...100]

Sets the Level of resonance of the voice pattern. This parameter sets the intensity of resonance for the voice pattern. A larger value will add more character to the sound.

### LFO

**Frequency [Hz]** [0.02...20.00]

This sets the LFO speed, in Hz. It applies only when **MIDI/Tempo Sync**, below, is **Off**.

**Source** [Off...Tempo]

This selects a modulation source for the **Frequency**.

**Amount** [-20.00...+20.00]

This sets the **Frequency** modulation amount, in Hz.

**MIDI/Tempo Sync** [Check-box]

**BPM** [MIDI, 40.00...300.00]

**Base Note** [♭...♯]

**Times** [x1...x32]

When **MIDI/Tempo Sync** is on, the LFO speed is set by **BPM**, **Base Note**, and **Times**, instead of **Frequency**. For more information, see “MIDI/Tempo Sync” on page 907.

**Type** [Individual, Common1, Common2]

This controls whether the effect uses its individual LFO, or one of the Common FX LFOs. For more information, see “LFO Type” on page 907.

**Common LFO Phase Offset [degrees]** [+/-180]

When **Type** is set to **Common FX LFO 1** or **2**, this lets you offset the phase from the master LFO.

### OUTPUT

This is the standard effects output section, with modulatable control over wet/dry balance. For more information, see “OUTPUT” on page 890.

## 022: Stereo Decimator

This effect creates a rough sound like a cheap sampler by lowering the sampling frequency, reducing the bit depth, and creating aliasing.

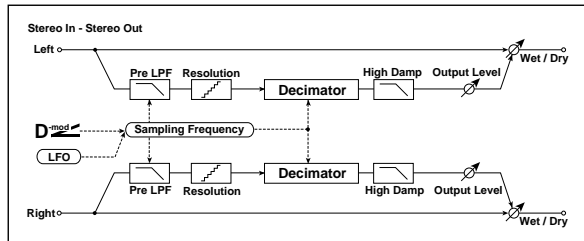

### DECIMATOR

**Pre LPF** [Check-box]

If a sampler (or other digital audio device) tries to record a pitch higher than half the sampling frequency, this generates a particular kind of pitched noise, called aliasing. Reducing the sampling frequency will tend to increase the amount of aliasing.

Set **Pre LPF** to ON to prevent aliasing, or leave it OFF to create aliasing artifacts.

To create a sound similar to a ring modulator, set the **Sampling Freq** to about 3kHz and set **Pre LPF** to OFF.

**Sampling Frequency [Hz]**  $D_{mod}$  [1.00k...48.00k]

Sets the sampling frequency.

**Source** [Off...Tempo]

Selects the modulation source of the sampling frequency.

**Amount** [-48.00k...+48.00k]

Sets the modulation amount of the sampling frequency.

**Depth**  $D_{mod}$  [0...100]

Sets the depth of the sampling frequency LFO modulation.

**Source** [Off...Tempo]

Selects the LFO modulation source of the sampling frequency.

**Amount** [+/-100]

Sets the LFO modulation amount of the sampling frequency.

**High Damp [%]** [0...100]

Sets the amount of high-frequency attenuation.

### BIT SHAPE

**Resolution [bits]** [4...24]

Sets the data bit length. With lower settings, the sound may be distorted, and the volume may increase. You can use the **Output Level** parameter, below, to adjust the volume as necessary.

**Output Level**  $D_{mod}$  [0...100]

Sets the output level.

**Source** [Off...Tempo]

Selects the modulation source for the output level.

**Amount** [+/-100]

Sets the modulation amount of the output level.

### LFO

**Frequency [Hz]**  $D_{mod}$  [0.02...20.00]

This sets the LFO speed, in Hz. It applies only when **MIDI/Tempo Sync**, below, is Off.

**Source** [Off...Tempo]

This selects a modulation source for the **Frequency**.

**Amount** [-20.00...+20.00]

This sets the **Frequency** modulation amount, in Hz.

**MIDI/Tempo Sync**  $D_{mod}$  [Check-box]

**BPM** [MIDI, 40.00...300.00]

**Base Note** [♩...♩]

**Times** [x1...x32]

When **MIDI/Tempo Sync** is on, the LFO speed is set by **BPM**, **Base Note**, and **Times**, instead of **Frequency**. For more information, see "MIDI/Tempo Sync" on page 907.

**Type** [Individual, Common1, Common2]

This controls whether the effect uses its individual LFO, or one of the Common FX LFOs. For more information, see "LFO Type" on page 907.

**Common LFO Phase Offset [degrees]** [+/-180]

When **Type** is set to **Common FX LFO 1** or **2**, this lets you offset the phase from the master LFO.

### OUTPUT

This is the standard effects output section, with modulatable control over wet/dry balance. For more information, see "OUTPUT" on page 890.

## 023: Stereo Analog Record

This effect simulates the noise caused by scratches and dust on analog records. It also reproduces some of the modulation caused by a warped turntable.

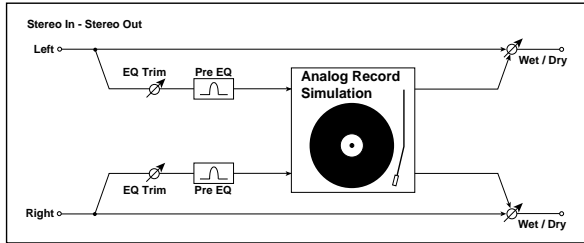

### Pre EQ

**Trim** [0...100]  
Sets the EQ input level.

**Fc [Hz]** [300...10.00k]  
Sets the EQ center frequency.

**Q** [0.5...10.0]  
Sets the EQ band width.

**Gain [dB]** [-18.0...+18.0]  
Sets the EQ gain.

### ANALOG RECORD

**Speed [RPM]** [33 1/3, 45, 78]  
Sets the rotation speed of the record.

**Flutter** [0...100]  
This parameter enables you to set the depth of the modulation caused by a warped turntable.

This parameter enables you to set the depth of the modulation caused by a warped turntable.

### NOISE

**Density** [0...100]  
Sets the noise density.

**Tone** [0...100]  
Sets the noise tone.

**Level**  $D_{mod}$  [0...100]  
Sets the noise level.

**Source** [Off...Tempo]  
Selects the modulation source for the noise level.

**Amount** [+/-100]  
Sets the modulation amount of the noise level.

### CLICK

**Level**  $D_{mod}$  [0...100]  
This parameter enables you to set the level of the click noise that occurs once every rotation of the turntable.

This simulation reproduces record noise, and the noise generated after the music on a vinyl record finishes.

**Source** [Off...Tempo]  
Selects the modulation source for the click noise level.

**Amount** [+/-100]  
Sets the modulation amount of the click noise level.

### OUTPUT

This is the standard effects output section, with modulatable control over wet/dry balance. For more information, see "OUTPUT" on page 890.

## 024: Stereo Wave Shaper

This is a stereo effect that reshapes the waveform of the input signal, generating numerous overtones that were not present in the original signal.

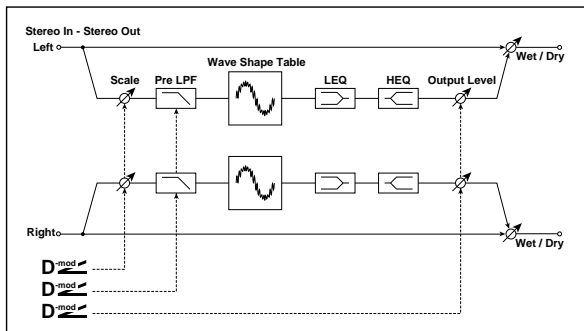

### WAVE SHAPER

**Wave Shape Table** [Sine...Wurly]  
The table determines the basic timbre of the effect.

Wave Shape Tables

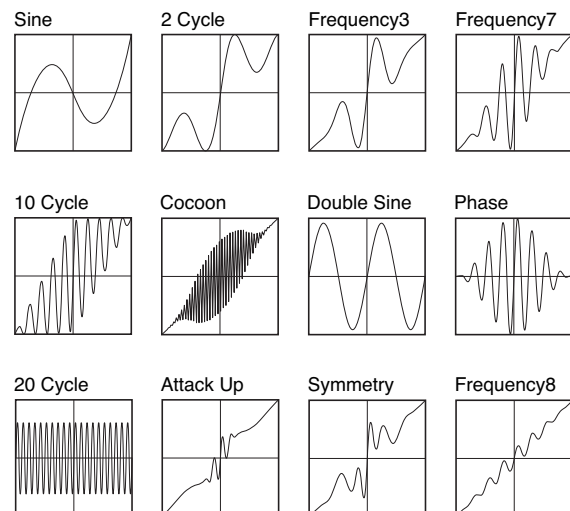



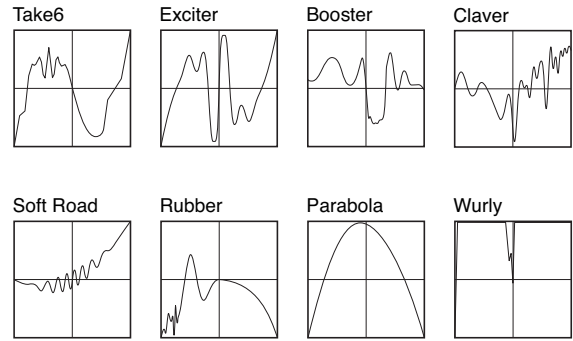
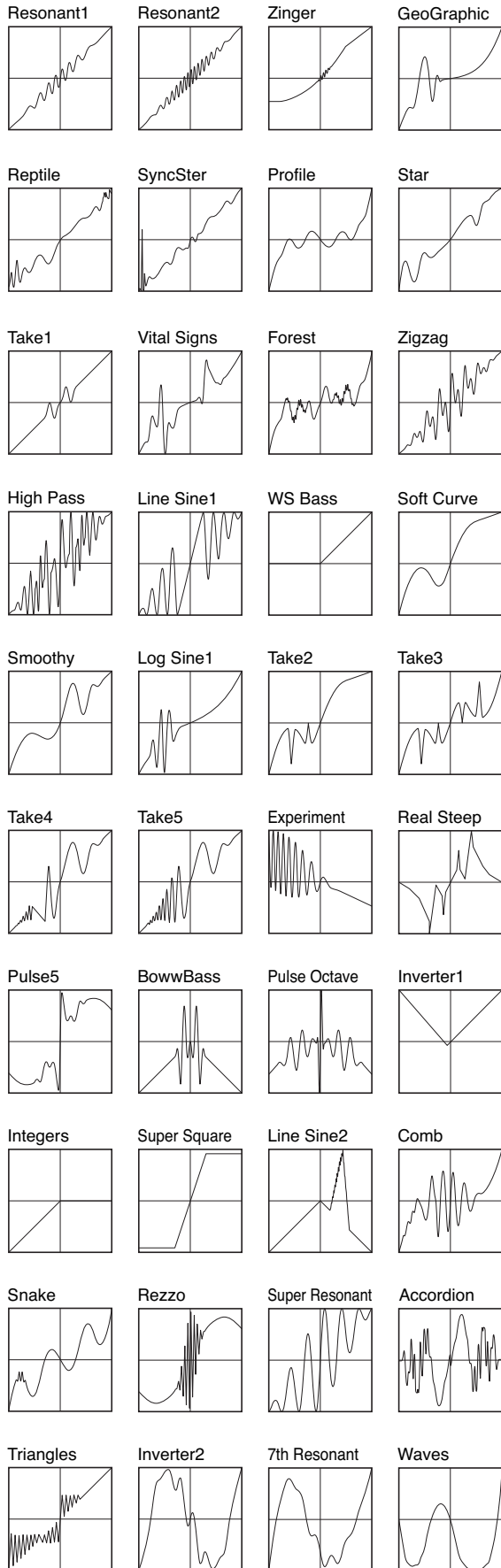

**Pre LPF**  $D_{mod}$  [0...100]

Sets the damping amount in the high range.

**Source** [Off...Tempo]

Selects the source that will modulate the amount of high range damping.

**Amount** [+/-100]

Sets the depth by which the amount of high range damping will be modulated.

**Scale [dB]**  $D_{mod}$  [-36...+36]

This sets the input level to the wave shape table. Even for the same waveform, changing the input level will dramatically modify the output waveform and the tone.

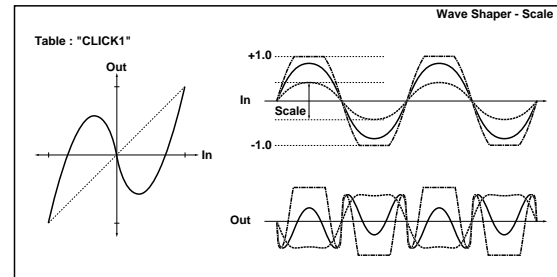

**Source** [Off...Tempo]

Selects the modulation source for the Scale.

**Amount** [-72...+72]

Selects the modulation amount for the Scale.

## EQ

**LEQ Fc** [Low, Mid-Low]

Selects the cutoff frequency (low or mid-low) of the low-range equalizer.

**LEQ Gain [dB]** [-15.0...+15.0]

Sets the gain of the Low EQ.

**HEQ Fc** [High, Mid-High]

Selects the cutoff frequency (high or mid-high) of the high-range equalizer.

**HEQ Gain [dB]** [-15.0...+15.0]

Sets the gain of the High EQ.

**Output Level**  $D_{mod}$  [0...100]

Sets the output level.

**Source** [Off...Tempo]

Selects the modulation source for the **Output Level**.

**Amount** [+/-100]

Sets the modulation amount for the **Output Level**.

**OUTPUT**

This is the standard effects output section, with modulatable control over wet/dry balance. For more information, see "OUTPUT" on page 890.

**025: Piano Body/Damper**

This effect simulates the resonance of the piano sound board caused by the string vibration, and also simulates the resonance of other strings that are not being played when you press the damper pedal. It will create a very realistic sound when applied to acoustic piano sounds.

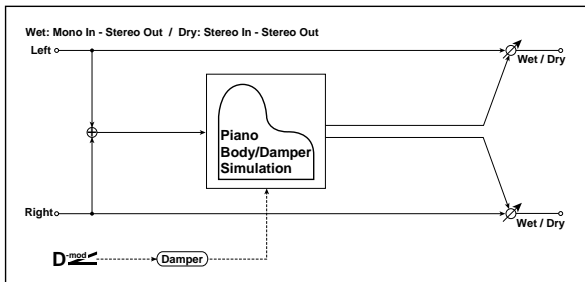

**SOUND BOARD**

**Depth** [0...100]

This parameter sets the intensity of the soundboard's resonance.

**DAMPER**

**Depth** [0...100]

This parameter sets the resonance intensity of the other strings created when the damper pedal is pressed. The **Source** parameter, below, selects the modulation source from which the damper effect is applied. Usually, select Damper (CC# 64).

**Source** [Off...Tempo]

Selects the modulation source of damper effect.

The effect is off when a value for the modulation source specified for the **Source** parameter is 63 or smaller, and the effect is on when the value is 64 or higher.

**TONE**

**Tone** [1...100]

This controls the brightness of the soundboard resonance.

**Mid Shape** [0...36]

This controls the mid-range frequencies of the resonance. Higher values **decrease** the amount of mid-range frequencies.

**Tune** [-50...+50]

This controls the fine-tuning of the resonance. Since this effect simulates the resonance of the strings, the sound varies depending on the pitch. If you have changed tuning using the "Master Tune" (Global P0), adjust this parameter value.

**OUTPUT**

This is the standard effects output section, with modulatable control over wet/dry balance. For more information, see "OUTPUT" on page 890.

**026: Vocoder**

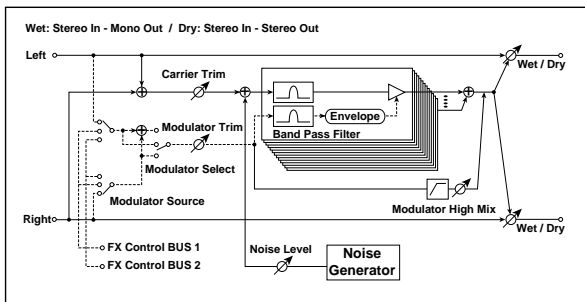

**Vocoder overview**

Vocoder effects superimpose the timbre of one signal (the modulator) onto that of a second signal (the carrier). The first vocoders were intended mostly for speech effects. For instance, you can produce the classic "talking synthesizer" sound by using a voice as a modulator and a bright synthesizer pad as a carrier.

This is only part of the effect's potential, however. You can use vocoders to combine practically any two sounds, as long as the frequency ranges overlap sufficiently. Drums make particularly good modulators, for instance.

A vocoder is essentially a combination of a multi-band frequency analyzer and a multi-band dynamic EQ. The modulator signal is divided up into a number of frequency bands, and the levels of each of these bands are measured in real time. A multi-band dynamic EQ is slaved to the analyzer, following the changes in each band of the modulator with similar changes in the EQ of the carrier. This causes the carrier to assume some of the timbre of the modulator.

It's best for the carrier to contain a wide range of frequencies. If there is little or no material in some of the bands to begin with, the EQ will have nothing to alter, and the vocoder's effect will be less distinct. If you want to use a particular sound as the carrier, but it

doesn't seem to have a sufficient frequency range, try using the **Noise Level** parameter to mix in some of the vocoder's built-in noise generator.

For instance, bright synthesizer sounds, distorted guitars, noise, or strings all make good carrier signals.

For more information on using vocoders, see "Vocoder (Program mode)" on page 861 and "Rhythmic Vocoder (Combination mode)" on page 862.

---

## Using the vocoder with a mic input

To use a voice from a microphone as a modulator:

1. **Connect a mic to Audio Input 1 or 2, and set the Input's LEVEL switch to MIC.**
2. **Go to the Global P0: Basic Setup-Audio page.**
3. **For the Audio Input to which you connected the mic, temporarily set Bus Select to L/R.**

This lets you listen to the mic input while adjusting the LEVEL control.

4. **While talking into the mic, use the LEVEL knob to adjust the level as high as possible without distortion.**

After adjusting the LEVEL, you can change the bus settings for use with the vocoder:

5. **For the Audio Input to which you connected the mic, turn Bus Select Off, and set FX Ctrl Bus Select to 1.**
6. **In the Vocoder effect, set the MODULATOR Source to FX Control Bus 1.**
7. **Route a synth sound into the Vocoder effect.**

With these settings, the sound from the mic will be used as the modulator. While you play, speak into the mic; it will sound as though the instrument is talking.

If the sound is distorted, adjust the **CARRIER Trim** and/or **MODULATOR Trim**.

---

## CARRIER

Note that the left and right inputs are always summed into the Carrier, regardless of the **MODULATOR Select** parameter below. To use a separate signal (such as a mic input) as the Modulator, route it through **FX Control Bus 1** or **2**.

**Trim** [0...100]

Sets the Carrier input level.

**Noise Level**  [0...100]

This controls the level of the built-in noise generator. You can mix this with the Carrier input, or set the Carrier Trim to 0 and use only the noise, if desired. You can also modulate the **Noise Level** using Dmod, controlled by the **Source** and **Amount** parameters below.

**Source** [Off...Tempo]

Selects the modulation source for the **Noise Level**.

**Amount** [+/-100]

Sets the modulation amount for the **Noise Level**.

---

## MODULATOR

**Trim** [0...100]

This controls the input level of the Modulator.

**Source** [Input, FX Control 1, FX Control 2]

Selects the signal to use as the Modulator input.

**Input** uses the input to the Vocoder effect. This is good when you want the input to "vocode" itself.

**FX Control 1** and **2** use the signal from the FX Control Buses. For classic vocoding effects, such as a mic input as the modulator and a synth as the carrier, you **must** use one of these buses.

**Select** [L/R Mix, L Only, R Only]

Selects whether to use the left/right mix, only the left channel, or only the right channel of the Modulator input.

---

## VOCODER

**Formant Shift** [-2...+2]

This lets you offset the Carrier filters, so that they are either higher or lower than the Modulator filters. This produces effects similar to transposing a sample, and produces significant changes in the overall character.

**Response** [0...100]

This controls how quickly the vocoder responds to changes in the Modulator. The default of 60 generally works well for most purposes.

Lower values produce slower response times, which can produce interesting sweeping effects. Higher values are useful for percussion, but can cause jittery response with smoother Modulator signals.

**Low Gain [dB]** [-12...+12]

Sets the low-range output level of the vocoder.

**High Gain [dB]** [-12...+12]

Sets the high-range output level of the vocoder.

**Modulator High Mix** [0...100]

This lets you mix a highpass-filtered version of the Modulator directly to the output, bypassing the main vocoder effect. When using a voice as the modulator, this can increase intelligibility.

---

## OUTPUT

This is the standard effects output section, with modulatable control over wet/dry balance. For more information, see "OUTPUT" on page 890.

## Overdrive, Amp models, and Mic models

### 027: OD/Hi-Gain Wah

This versatile effect offers two different-sounding distortion modes (Overdrive and Hi-Gain), a modulatable wah-wah filter, a speaker simulation, and 3-band EQ. It's suitable for guitars, organs, and general sonic mayhem.

For a description of the on-screen EQ graphic, see “011: Stereo Parametric 4EQ” on page 902.

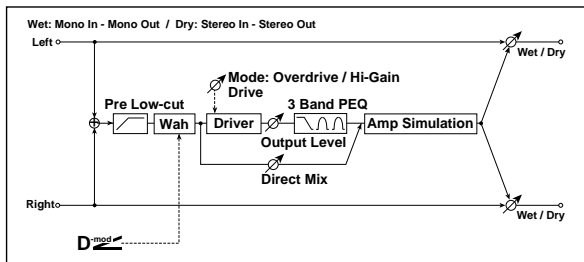

#### WAH

##### Wah Switch

**Wah Switch** [Off, On]

This turns the Wah effect on and off.

**Source** [Off...Tempo]

Selects the modulation source that switches the Wah on and off.

**Mode** [Toggle, Moment]

This parameter controls how the modulation source switches the overdrive on and off.

When **Mode** = **Toggle**, the overdrive turns on or off each time you press the pedal or move the joystick. Via MIDI, overdrive turns on or off each time the modulation amount exceeds 64.

When **Mode** = **Moment** (short for Momentary), the overdrive is normally off, and turns on only when you press the pedal or move the joystick. Via MIDI, modulation values above 64 turn it on, and values below 64 turn it off.

##### Wah Sweep

**Sweep Range** [-10...+10]

This controls the width of the Wah's sweep, from the minimum to maximum values of the modulation **Source** selected below.

Negative values reverse the sweep's direction, from high to low instead of low to high.

**Source** [Off...Tempo]

This selects a modulation source to control the Wah.

#### DRIVE

**Pre Low-cut** [0...10]

This attenuates low frequencies before the signal enters the distortion. Use this to create a sharper tone.

**Drive Mode** [Overdrive, Hi-Gain]

This switches between two different distortion timbres: overdrive and hi-gain distortion.

**Drive** [1...100]

The amount of distortion is determined by the combination of the input level and the **Drive** setting. Higher input levels, and/or higher **Drive** settings, mean more distortion.

Raising the **Drive** setting will also increase the volume; you can compensate for this by lowering the **Output Level** parameter, below.

**Direct Mix** [0...50]

Sets the amount of the dry sound mixed to the distortion.

**Speaker Simulation** [Check-box]

Switches the speaker simulation on/off.

**Output Level** [0...50]

This controls the output volume from the Drive section into the 3-band EQ. You can use this to reduce the volume to compensate for high Drive settings, or to prevent clipping in the EQ.

**Source** [Off...Tempo]

Selects the modulation source for the output level.

**Amount** [-50...+50]

Sets the modulation amount for the output level.

#### EQ

**Low Fc [Hz]** [20...1.00k]

Sets the center frequency for Low EQ (shelving type).

**Gain [dB]** [-18...+18]

Sets the gain of the Low EQ.

**Mid1 Fc [Hz]** [300...10.00k]

Sets the center frequency for Mid EQ 1 (peaking type).

**Q** [0.5...10.0]

Sets the band width of Mid EQ 1. p.902.

**Gain [dB]** [-18...+18]

Sets the gain of Mid EQ 1.

**Mid2 Fc [Hz]** [500...20.00k]

Sets the center frequency for Mid EQ 2 (peaking type).

**Q** [0.5...10.0]  
Sets the band width of Mid EQ 2. See "Q" on page 902.

**Gain [dB]** [-18...+18]  
Sets the gain of Mid EQ 2.

## 028: OD/HyperGain Wah

This distortion effect has two modes: overdrive and hyper-gain that produces a strong distortion. A higher high-gain setting is required for this effect relative to a normal-size effect.

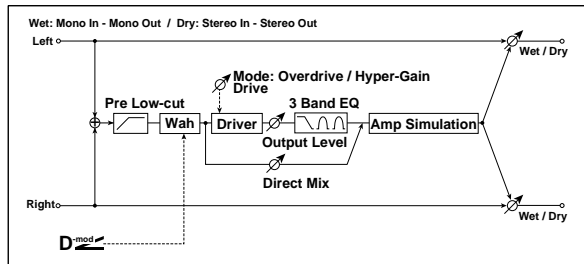

### WAH

**Wah Switch** [Off, On]

**Source** [Off...Tempo]

**Mode** [Toggle, Moment]

These parameters let you turn the Wah on and off from either the LCD or a controller, and determine how the controller works. For more information, see "Wah Switch" on page 918.

**Sweep Range** [-10...+10]

**Source** [Off...Tempo]

These parameters set the modulation source and amount for the Wah. For more information, see "Wah Sweep" on page 918.

### DRIVE

**Pre Low-cut** [0...10]

This attenuates low frequencies before the signal enters the distortion. Use this to create a sharper tone.

**Drive Mode** [Overdrive, Hyper-Gain]

Switches between overdrive and hyper-gain mode.

**Drive** [1...120]

Sets the degree of distortion. For more information, see "DRIVE" on page 918.

**Direct Mix** [0...50]

Amount of the dry sound mixed to the distortion.

**Speaker Simulation** [Check-box]

Speaker simulation on/off.

**Output Level** [0...50]

Sets the output level. For more information, see "DRIVE" on page 919.

### OUTPUT

This is the standard effects output section, with modulatable control over wet/dry balance. For more information, see "OUTPUT" on page 890.

**Source** [Off...Tempo]

Selects the modulation source for the output level.

**Amount** [-50...+50]

Sets the modulation amount of the output level.

### EQ

**Low Fc [Hz]** [20...1.00k]

Sets the center frequency for Low EQ (shelving type).

**Gain [dB]** [-18...+18]

Sets the gain of the Low EQ.

**Mid1 Fc [Hz]** [300...10.00k]

Sets the center frequency for Mid/High EQ 1 (peaking type).

**Q** [0.5...10.0]

Sets the band width of Mid/High EQ 1. See "Q" on page 902.

**Gain [dB]** [-18...+18]

Sets the gain of Mid/High EQ 1.

**Mid2 Fc [Hz]** [500...20.00k]

Sets the center frequency for Mid/High EQ 2 (peaking type).

**Q** [0.5...10.0]

Sets the band width of Mid/High EQ 2.

**Gain [dB]** [-18...+18]

Sets the gain of Mid/High EQ 2.

### OUTPUT

This is the standard effects output section, with modulatable control over wet/dry balance. For more information, see "OUTPUT" on page 890.

## 029: Stereo Guitar Cabinet

This simulates the acoustical character of a guitar amp's speaker cabinet.

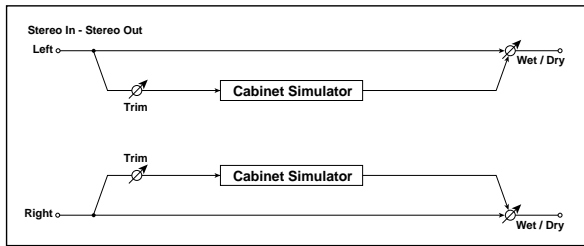

### CABINET SIMULATOR

**Trim** [0...100]

Sets the input level.

## 030: Guitar Amp Model +P4EQ

This combines a guitar amp simulation (which even faithfully replicates the distortion and tone control circuitry) with a four-band equalizer.

For a description of the EQ graphic, see "011: Stereo Parametric 4EQ" on page 902.

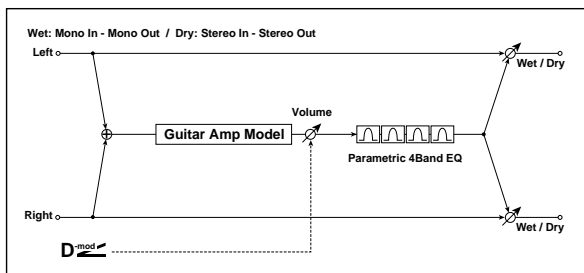

### GUITAR AMP MODEL

**Type** [AC15, AC15TB, AC30, AC30TB, UK BLUES, UK 70'S, UK 80'S, UK 90'S, UK MODERN, US MODERN, US HIGAIN, BOUTIQUE OD, BOUTIQUE CL, BLACK 2x12, TWEED 1x12, TWEED 4x10]

Selects the type of the amplifier. For more information, see "Type" on page 921.

**Gain** [0...100]

Sets the input gain.

**Volume** [0...100]

Sets the output level.

**Source** [Off...Tempo]

Selects the modulation source for the output level.

**Amount** [+/-100]

Sets the modulation amount of the output level.

**Bass** [0...100]

Sets the bass (low range) level.

**Type** [TWEED 1x12, TWEED 4x10, BLACK 2x10, BLACK 2x12, AC15, AC30, AD412, UK H30, UK T75, US V30]

Selects the type of the cabinet. See "031: Guitar Amp Model +Cabinet" on page 921.

**Air** [0...100]

Sets the mic position.

### OUTPUT

This is the standard effects output section, with modulatable control over wet/dry balance. For more information, see "OUTPUT" on page 890.

**Middle** [0...100]

Sets the middle (mid range) level.

**Treble** [0...100]

Sets the treble (high range) level.

**Cut / Presence** [0...100]

This controls the high-frequency tone.

If the **Type** is AC15...AC30TB, the **Cut** (high frequency attenuation) parameter is available. For other **Type** settings, the **Presence** (high frequency boost) parameter is available.

### PARAMETRIC EQ

**Band1 Fc [Hz]** [20...1.00k]

Sets the center frequency of Band 1.

**Q** [0.5...10.0]

Sets Band 1's bandwidth.

**Gain [dB]** [-18...+18]

Sets the gain of Band 1.

**Band2 Fc [Hz]** [50...5.00k]

Sets the center frequency of Band 2.

**Q** [0.5...10.0]

Sets Band 2's bandwidth.

**Gain [dB]** [-18...+18]

Sets the gain of Band 2.

**Band3 Fc [Hz]** [300...10.00k]

Sets the center frequency of Band 3.

**Q** [0.5...10.0]

Sets Band 3's bandwidth.

**Gain [dB]** [-18...+18]

Sets the gain of Band 3.

- Band4 Fc [Hz]** [500...20.00k]  
Sets the center frequency of Band 4.
- Q** [0.5...10.0]  
Sets Band 4's bandwidth.
- Gain [dB]** [-18...+18]  
Sets the gain of Band 4.

## 031: Guitar Amp Model +Cabinet

This simulates a guitar amp and speaker cabinet.

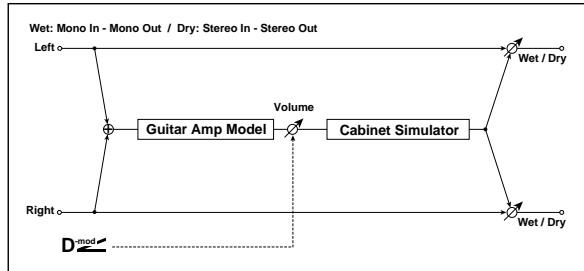

### GUITAR AMP MODEL

**Type** [AC15, AC15TB, AC30, AC30TB, UK BLUES, UK 70'S, UK 80'S, UK 90'S, UK MODERN, US MODERN, US HIGAIN, BOUTIQUE OD, BOUTIQUE CL, BLACK 2x12, TWEED 1x12, TWEED 4x10]

Selects the type of the amplifier. For more information, see "Recommended Combinations of Guitar Amp Models and Cabinet Simulators" on page 922.

**AC15:** VOX AC15 manufactured in 1962.

**AC15TB:** VOX AC15TB (an AC15 modified by the addition of a top boost circuit).

**AC30:** Normal channel of a VOX AC30TB.

**AC30TB:** Brilliant channel of a VOX AC30TB.

**UK BLUES:** UK-manufactured vintage stack amp head.

**UK 70'S:** High treble channel of a UK-manufactured 100W amp head from 1969.

**UK 80'S:** UK-manufactured 100 Watt head from 1983.

**UK 90'S:** Lead channel of a 100W dual channel head.

**UK MODERN:** UK-manufactured 100W modern amp.

**US MODERN:** High-gain amp with metal plate.

**US HIGAIN:** 1991 model 100W amp head covered in snake- skin.

**BOUTIQUE OD:** Overdrive channel of a high-end 100W hand made amp.

**BOUTIQUE CL:** Clean channel of a high-end, hand-made 100W amp.

**BLACK 2x12:** 2x12 combo amp indispensable for country or blues players.

**TWEED 1x12:** Combo amp covered in tweed cloth.

**TWEED 4x10:** 4x10 combo amp designed for bass guitar.

### OUTPUT

This is the standard effects output section, with modulatable control over wet/dry balance. For more information, see "OUTPUT" on page 890.

- Gain** [0...100]  
Sets the input gain.
- Volume** [0...100]  
Sets the output level.
- Source** [Off...Tempo]  
Selects the modulation source for the output level.
- Amount** [+/-100]  
Sets the modulation amount of the output level.
- Bass** [0...100]  
Sets the bass (low range) level.
- Middle** [0...100]  
Sets the middle (mid range) level.
- Treble** [0...100]  
Sets the treble (high range) level.
- Cut / Presence** [0...100]  
Sets the presence (high-frequency tone). p.920.
- Cabinet Sim SW** [Check-box]  
Switches the cabinet simulator on/off.

### CABINET SIMULATOR

- Type** [See Below]  
Selects the type of the cabinet. p.922.
- TWEED 1x12:** Open-back cabinet with one 12" speaker, typically used for blues.
- TWEED 4x10:** Open-back cabinet with four 10" speakers.
- BLACK 2x10:** Open-back cabinet with two 10" speakers.
- BLACK 2x12:** American open-back cabinet with two 12" speakers.
- AC15:** Vox open-back cabinet with one 12" "Blue" speaker.
- AC30:** Vox open-back cabinet with two 12" "Blue" speakers.
- AD412:** VOX AD412 closed-back cabinet with four 12" speakers.
- UK H30:** Closed-back classic cabinet with four 30W 12" speakers.
- UK T75:** Closed-back cabinet with four 75W 12" speakers.



**US V30:** Closed-back cabinet with four 30W 12" speakers.

**Air** [0...100]

Sets the mic position.

**OUTPUT**

This is the standard effects output section, with modulatable control over wet/dry balance. For more information, see "OUTPUT" on page 890.

**Recommended Combinations of Guitar Amp Models and Cabinet Simulators**

AMP MODEL	CABINET
AC15	AC15
AC15TB	AC15
AC30	AC30
AC30TB	AC30
UK BLUES	UK H30
UK 70'S	UK H30
UK 80'S	UK T75

AMP MODEL	CABINET
UK 90'S	UK T75
UK MODERN	UK T75, US V30
US MODERN	US V30
US HIGAIN	US V30, UK T75
BOUTIQUE OD	UK H30
BOUTIQUE CL	UK H30
BLACK 2x12	BLACK 2x12
TWEED 1x12	TWEED 1x12
TWEED 4x10	TWEED 4x10

**032: Stereo Bass Cabinet**

This simulates the acoustical character of a bass amp's speaker cabinet.

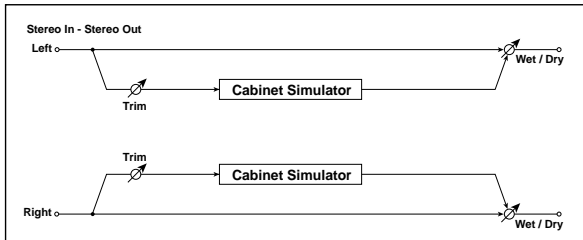

**CABINET SIMULATOR**

**Trim** [0...100]

Sets the input level.

**Type** [LA 4x10, MDN 4x10, MTL 4x10, CLS 8x10, UK 4x12, STD 1x15, JAZ 1x15, AC 2x15, US 2x15, UK 4x15, LA 1x18, COMBI]

Selects the cabinet type. See "034: Bass Amp Model +Cabinet" on page 923.

**OUTPUT**

This is the standard effects output section, with modulatable control over wet/dry balance. For more information, see "OUTPUT" on page 890.

**033: Bass Amp Model**

This simulates a bass amp.

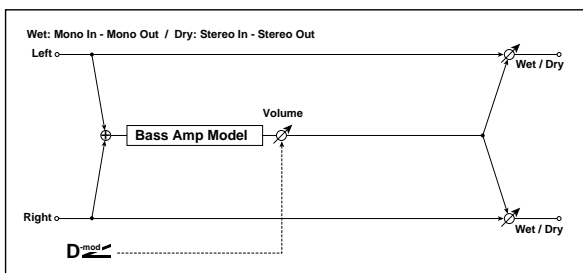

**BASS AMP MODEL**

**Type** [LA STUDIO, JAZZ, GOLD PANEL, SCOOPED, VALVE2, VALVE, CLASSIC]

Selects the type of the amplifier. For more information, see "034: Bass Amp Model +Cabinet" on page 923.

**Volume** [0...100]

Sets the output level.

**Source** [Off...Tempo]

Selects the modulation source for the output level.

<b>Amount</b>	[+/-100]
Sets the modulation amount of the output level.	
<b>Bass</b>	[0...100]
Sets the bass (low range) level.	
<b>Middle</b>	[0...100]
Sets the middle (mid range) level.	
<b>Mid Range</b>	[0...4]
Sets the mid-frequency range.	

<b>Treble</b>	[0...100]
Sets the treble (high range) level.	
<b>Presence</b>	[0...100]
Sets the presence (high-frequency tone).	

---

**OUTPUT**

This is the standard effects output section, with modulatable control over wet/dry balance. For more information, see "OUTPUT" on page 890.

---

**034: Bass Amp Model +Cabinet**

This simulates a bass amp and speaker cabinet.

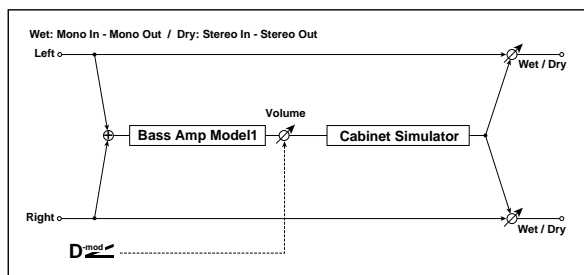

---

**BASS AMP MODEL**

**Type** [LA STUDIO, JAZZ, GOLD PANEL, SCOOPED, VALVE2, VALVE, CLASSIC]

Selects the amplifier type. See "Recommended Combinations of Bass Amp Models and Cabinets" on page 924.

**LA STUDIO:** An amp typical of the LA sound.

**JAZZ:** A combo amp favored by jazz bassists.

**GOLD PANEL:** An amp distinctive for its eye-catching gold panel and clean sound.

**SCOOPED:** An amp typical of 80's sounds.

**VALVE2:** A tube amp suitable for rock.

**VALVE:** A tube amp with the ULTRA LO switch turned ON.

**CLASSIC:** A tube amp whose basic character changes according to the setting of the value dial.

**Volume** [0...100]

Sets the output level.

**Source** [Off...Tempo]

Selects the modulation source for the output level.

**Amount** [+/-100]

Sets the modulation amount of the output level.

**Bass** [0...100]

Sets the bass (low range) level.

**Middle** [0...100]

Sets the middle (mid range) level.

**Mid Range** [0...4]

Sets the mid-frequency range.

**Treble** [0...100]

Sets the treble (high range) level.

**Presence** [0...100]

Sets the presence (high-frequency tone).

---

**CABINET SIMULATOR**

**Cabinet Sim SW** [Check-box]

Switches the cabinet simulator on/off.

**Type** [LA 4x10, MDN 4x10, MTL 4x10, CLS 8x10, UK 4x12, STD 1x15, JAZ 1x15, AC 2x15, US 2x15, UK 4x15, LA 1x18, COMBI]

Selects the cabinet type. See "Recommended Combinations of Bass Amp Models and Cabinets" on page 924.

**LA 4x10:** Four 10" speakers; LA sound.

**MDN 4x10:** Four 10" speakers; modern cabinet.

**MTL 4x10:** Four 10" aluminum-cone speakers; modern cabinet.

**CLS 8x10:** Eight 10" speakers; classic cabinet.

**UK 4x12:** Four 12" speakers; UK-manufactured cabinet.

**STD 1x15:** One 15" speaker; studio combo cabinet.

**JAZ 1x1:** One 15" speaker; jazz combo cabinet.

**AC 2x15:** Two 15" speakers; cabinet for AC100.

**US 2x15:** Two 15" speakers; US-manufactured cabinet.

**UK 4x15:** Four 15" speakers; UK-manufactured cabinet.

**LA 1x18:** One 18" speaker; LA sound.

**COMBI:** One 12" and one 18" speaker combination cabinet.

---

**OUTPUT**

This is the standard effects output section, with modulatable control over wet/dry balance. For more information, see "OUTPUT" on page 890.

## Recommended Combinations of Bass Amp Models and Cabinets

AMP MODEL	CABINET
LA STUDIO	LA 4X10 or LA 1X18
JAZZ	JAZ 1X15
GOLD PANEL	MDN 4X10
SCOOPED	MTL 4X10
VALVE2	CLS 8X10
VALVE	CLS 8X10
CLASSIC	COMBI

### 035: Bass Amp TubeDrive +Cab

This simulates a bass amp (with gain and drive) and speaker cabinet.

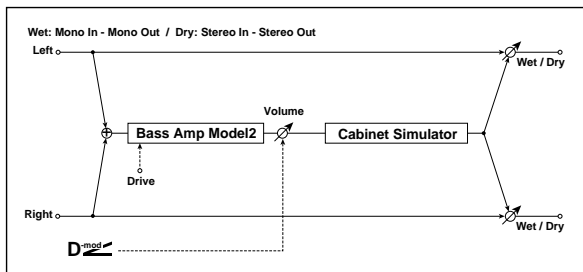

#### BASS AMP MODEL

**Amplifier Type** [STUDIO, AC100, UK MAJOR]

Selects the type of the amplifier. p.924.

**STUDIO:** A tube combo ideal for the Motown sound.

**AC100:** A 100W tube amp made by Vox.

**UK MAJOR:** A 200W tube amp made in the UK.

**Gain** [0...100]

Sets the input gain.

**Volume** [0...100]

Sets the output level.

**Source** [Off...Tempo]

Selects the modulation source for the output level.

**Amount** [+/-100]

Sets the modulation amount of the output level.

**Bass** [0...100]

Sets the bass (low range) level.

**Middle** [0...100]

Sets the middle (mid range) level.

**Treble** [0...100]

Sets the treble (high range) level.

**Presence** [0...100]

Sets the presence (high-frequency tone).

#### CABINET SIMULATOR

**Cabinet Sim SW** [Check-box]

Switches the cabinet simulator on/off.

**Cabinet Type** [LA 4x10, MDN 4x10, MTL 4x10, CLS 8x10, UK 4x12, STD 1x15, JAZ 1x15, AC 2x15, US 2x15, UK 4x15, LA 1x18, COMBI]

Selects the cabinet type. See "034: Bass Amp Model +Cabinet" on page 923, and "Recommended Combinations of Bass Amp Models and Cabinets" on page 924.

#### OUTPUT

This is the standard effects output section, with modulatable control over wet/dry balance. For more information, see "OUTPUT" on page 890.

#### Recommended Combinations of Bass Amp Models and Cabinets

AMP MODEL	CABINET
STUDIO	STD 1X15
AC100	AC 2X15
UK MAJOR	UK 4X15, UK 4X12

## 036: Tube PreAmp Modeling

This effect simulates a two-stage vacuum tube preamp. You can make individual settings for two vacuum tubes connected in series. This lets you create the warm sound typical of vacuum tubes.

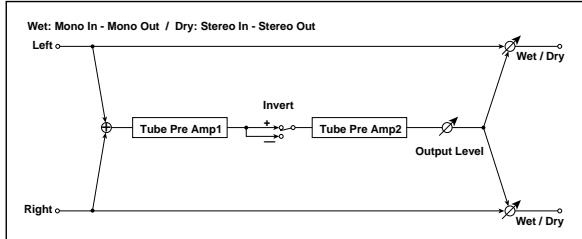

### TUBE PREAMP1

**Low Cut [Hz]** [Thru, 21...8.00k]

Sets the cutoff frequency for the low cut filter of stage 1.

**High Cut [Hz]** [53...20.00k, Thru]

Sets the cutoff frequency for the high cut filter of stage 1.

**Gain [dB]** [-Inf, -38...+24]

Sets the input gain for stage 1.

**Saturation [%]** [0...100]

Sets the input/output response for stage 1. See "Saturation [%]" on page 926.

**Bias** [0...100]

Sets the bias voltage for stage 1. See "Bias" on page 926.

**Phase** [Normal, Wet Invert]

Turns phase reversal on/off.

With the Wet Invert setting, the phase of the signal will be inverted between stage 1 and stage 2. Since "Bias" is applied to the inverted signal in stage 2, this will change the tonal character.

### TUBE PREAMP2

**Low Cut [Hz]** [Thru, 21...8.00k]

**High Cut [Hz]** [53...20.00k, Thru]

**Gain [dB]** [-24.0...+24.0]

**Saturation [%]** [0...100]

**Bias** [0...100]

These parameters are identical to those for "TUBE PREAMP1," above.

**Output Level [dB]** [-48.0...+0.0]

Sets the output level.

### OUTPUT

**Wet/Dry** [Dry, 1:99...99:1, Wet]

Sets the balance between the effect and the dry input.

**Source** [Off...Tempo]

Selects a modulation source for Wet/Dry.

**Amount** [+/-100]

Sets the modulation amount for Wet/Dry.

## 037: St. Tube PreAmp Modeling

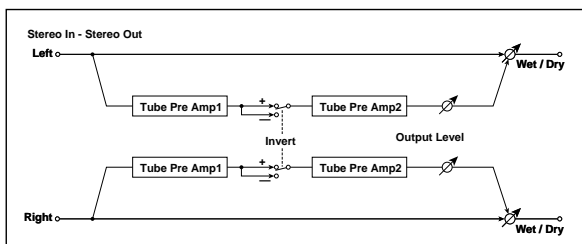

This is similar to "036: Tube PreAmp Modeling", but in stereo.

For more information, see "036: Tube PreAmp Modeling" on page 925.

## 038: Mic Modeling +PreAmp

This effect simulates a mic and vacuum tube preamp. You can choose from various types of mic and positions to create differing sonic characters.

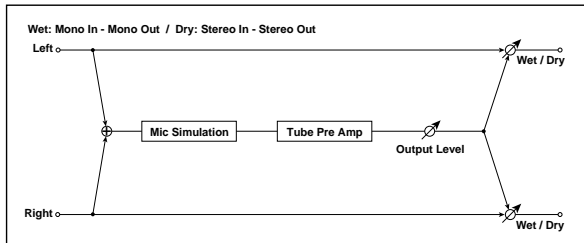

### MIC SIMULATOR

**Type** [Vnt.Dy/55SH, Mlt.Cn/C414, Pc.Cn/C451, Whale/MD421, Vo.Dy/SM58, Mlt.Dy/SM57, Vo.Cn/U87, Vo.Tube/U47, BDr.Dy/RE20]

Selects the type of mic.

**Position** [Close, On, Off, Far]

This expresses the effect that the mic position has on the sound. The Close setting is the closest mic position, and the Far setting is the farthest.

### TUBE PREAMP

**Low Cut [Hz]** [Thru, 21...8.00k]

Sets the frequency of the low cut filter.

**High Cut [Hz]** [53...20.00k, Thru]

Sets the frequency of the high cut filter.

**Gain [dB]** [-24.0...+24.0]

Sets the input gain to the vacuum tube preamp.

**Saturation [%]** [0...100]

Sets the input/output response of the preamp.

At higher settings, the waveform will change at high gain levels, tending to cause distortion. Lower settings will produce linear response.

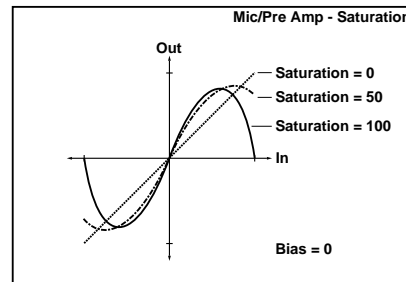

### Bias

[0...100]

This expresses the effect that changes in vacuum tube bias have on the distortion of the waveform. Higher settings of this value will produce distortion even at low gain levels. Since this will also change the overtone structure, you can use it to control the tonal character.

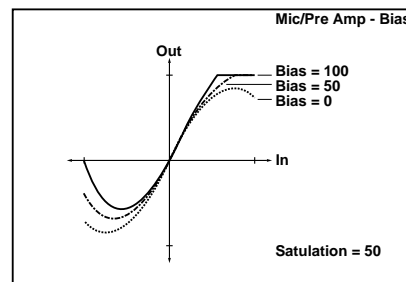

### Output Level [dB]

[-48.0...+0.0]

Sets the output level of the preamp.

### OUTPUT

This is the standard effects output section, with modulatable control over wet/dry balance. For more information, see "OUTPUT" on page 890.

## 039: St. Mic Modeling +PreAmp

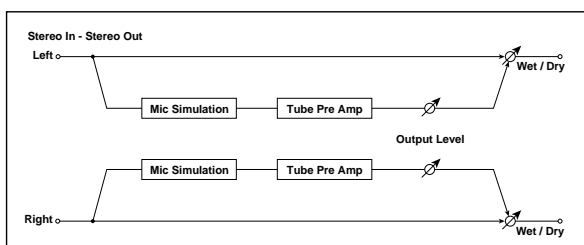

This is similar to "038: Mic Modeling +PreAmp", but in stereo. For example, you might use this to simulate micing of a stereo source such as a rotary speaker.

For more information, see "038: Mic Modeling +PreAmp" on page 926.

## Chorus, Flanger, and Phaser

### 040: Stereo Chorus

This effect adds thickness and warmth to the sound by modulating the delay time of the input signal. You can add spread to the sound by offsetting the phase of the left and right LFOs from each other.

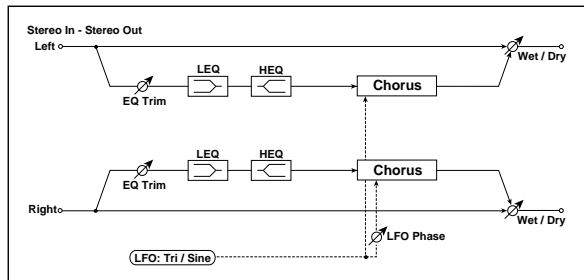

#### Pre EQ

**Trim** [0...100]

Sets the EQ input level.

**LEQ Fc** [Low, Mid-Low]

Selects the cutoff frequency (low or mid-low) of the low-range equalizer.

**LEQ Gain [dB]** [-15.0...+15.0]

Sets the gain of the Low EQ.

**HEQ Fc** [High, Mid-High]

Selects the cutoff frequency (high or mid-high) of the high-range equalizer.

**HEQ Gain [dB]** [-15.0...+15.0]

Sets the gain of the High EQ.

#### LFO

**Waveform** [Triangle, Sine]

Selects the LFO Waveform.

**Phase [degrees]** [-180...+180]

Sets the LFO phase difference between the left and right. See "Phase [degrees]" on page 909.

**Frequency [Hz]**  $D_{mod}$  [0.02...20.00]

This sets the LFO speed, in Hz. It applies only when **MIDI/Tempo Sync**, below, is **Off**.

**Source** [Off...Tempo]

This selects a modulation source for the **Frequency**.

**Amount** [-20.00...+20.00]

This sets the **Frequency** modulation amount, in Hz.

**MIDI/Tempo Sync**  $D_{mod}$  [Check-box]

**BPM** [MIDI, 40.00...300.00]

**Base Note** [Musical Note]

**Times** [x1...x32]

When **MIDI/Tempo Sync** is on, the LFO speed is set by **BPM**, **Base Note**, and **Times**, instead of **Frequency**. For more information, see "MIDI/Tempo Sync" on page 907.

**Type** [Individual, Common1, Common2]

This controls whether the effect uses its individual LFO, or one of the Common FX LFOs. For more information, see "LFO Type" on page 907.

**Common LFO Phase Offset [degrees]** [+/-180]

When **Type** is set to **Common FX LFO 1** or **2**, this lets you offset the phase from the master LFO.

#### CHORUS

**L Pre Delay [msec]** [0.0...50.0]

Sets the delay time for the left channel. Setting the left and right delay times to slightly different values allows you to control the stereo image.

**R Pre Delay [msec]** [0.0...50.0]

Sets the delay time for the right channel.

**Depth**  $D_{mod}$  [0...100]

Sets the depth of LFO modulation.

**Source** [Off...Tempo]

Selects the modulation source for the LFO modulation depth.

**Amount** [+/-100]

Sets the modulation amount of the LFO modulation depth.

#### OUTPUT

This is the standard effects output section, with modulatable control over wet/dry balance. For more information, see "OUTPUT" on page 890.

## 041: Stereo Harmonic Chorus

This effect applies chorus only to higher frequencies. This can be used to apply a chorus effect to a bass sound without making the sound thinner. You can also use feedback to turn the chorus into a flanger.

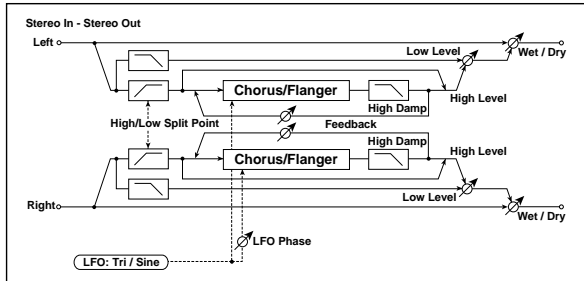

### CHORUS

**Pre Delay [msec]** [0.0...50.0]

Sets the delay time from the original sound.

**Depth** D<sub>mod</sub> [0...100]

Sets the depth of LFO modulation.

**Source** [Off...Tempo]

Selects the modulation source of the LFO modulation depth.

**Amount** [+/-100]

Sets the modulation amount of the LFO modulation depth.

**Feedback** [+/-100]

Sets the feedback amount for the chorus. Increasing the feedback turns the chorus into a flanger.

**High Damp [%]** [0...100]

Sets the amount of high-frequency attenuation for the chorus.

**High/Low Split Point** [1...100]

This sets the frequency split point between the low and high ranges. Only the high range will be processed through the chorus.

**Low Level** [0...100]

Sets the low range output level.

**High Level** [0...100]

Sets the high range (chorus) output level.

### LFO

**Waveform** [Triangle, Sine]

Selects the LFO Waveform.

**Phase [degrees]** [-180...+180]

Sets the LFO phase difference between the left and right. See "Phase [degrees]" on page 909.

**Frequency [Hz]** D<sub>mod</sub> [0.02...20.00]

This sets the LFO speed, in Hz. It applies only when **MIDI/Tempo Sync**, below, is **Off**.

**Source** [Off...Tempo]

This selects a modulation source for the **Frequency**.

**Amount** [-20.00...+20.00]

This sets the **Frequency** modulation amount, in Hz.

**MIDI/Tempo Sync** D<sub>mod</sub> [Check-box]

**BPM** [MIDI, 40.00...300.00]

**Base Note** [ ]

**Times** [x1...x32]

When **MIDI/Tempo Sync** is on, the LFO speed is set by **BPM**, **Base Note**, and **Times**, instead of **Frequency**. For more information, see "MIDI/Tempo Sync" on page 907.

**Type** [Individual, Common1, Common2]

This controls whether the effect uses its individual LFO, or one of the Common FX LFOs. For more information, see "LFO Type" on page 907.

**Common LFO Phase Offset [degrees]** [+/-180]

When **Type** is set to **Common FX LFO 1** or **2**, this lets you offset the phase from the master LFO.

### OUTPUT

This is the standard effects output section, with modulatable control over wet/dry balance. For more information, see "OUTPUT" on page 890.



## 042: St. Bi-phase Modulation

This stereo chorus effect adds two different LFOs together. You can set the Frequency and Depth parameters for each LFO individually. Depending on the setting of these LFOs, very complex waveforms will create an analog-type, unstable modulated sound.

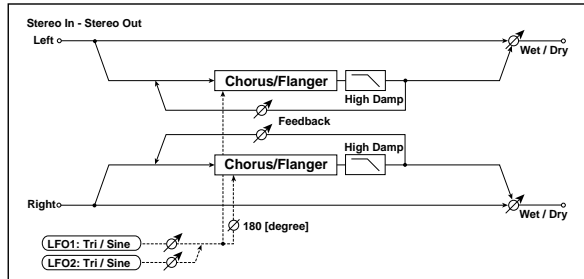

### MODULATION

**L Pre Delay [msec]** [0.0...50.0]

Sets the delay time for the left channel. p.927.

**R Pre Delay [msec]** [0.0...50.0]

Sets the delay time for the right channel. p.927.

**Depth1** D<sup>mod</sup> [0...100]

Sets the depth of LFO1 modulation.

**Depth2** D<sup>mod</sup> [0...100]

Sets the depth of LFO2 modulation.

**Source** [Off...Tempo]

Selects the modulation source of LFO1&2 modulation depth.

**Amount1** [+/-100]

Sets the modulation amount of LFO1 modulation depth.

**Amount2** [+/-100]

Sets the modulation amount of LFO2 modulation depth.

**Feedback** [+/-100]

Sets the feedback amount. See "Feedback" on page 928.

**High Damp [%]** [0...100]

Sets the amount of high-frequency attenuation.

### LFO1/2

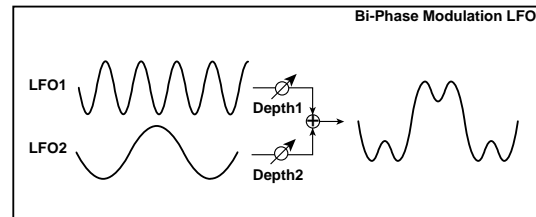

**LFO1 Waveform** [Triangle, Sine]

Selects the waveform for LFO1.

**LFO2 Waveform** [Triangle, Sine]

Selects the waveform for LFO2.

**Phase Sw** [0 degree, 180 degree]

This lets you invert the LFO phase between the left and right channels.

**LFO1 Frequency [Hz]** D<sup>mod</sup> [0.02...30.00]

This sets the speed of LFO1, in Hz.

**LFO2 Frequency [Hz]** D<sup>mod</sup> [0.02...30.00]

This sets the speed of LFO2, in Hz.

**Source** [Off...Tempo]

Selects a source to modulate the speeds of LFO1 & 2.

**LFO1 Amount** [-30.00...+30.00]

This sets the LFO1 Frequency modulation amount, in Hz.

**LFO2 Amount** [-30.00...+30.00]

This sets the LFO2 Frequency modulation amount, in Hz.

**LFO1 Type** [Individual, Common1, Common2]

This controls whether the effect uses its individual LFO1, or one of the Common FX LFOs. For more information, see "LFO Type" on page 907.

**Common LFO Phase Offset [degrees]** [+/-180]

When **Type** is set to **Common FX LFO 1** or **2**, this lets you offset the phase from the master LFO.

**LFO2 Type** [Individual, Common1, Common2]

This controls whether the effect uses its individual LFO2, or one of the Common FX LFOs. For more information, see "LFO Type" on page 907.

**Common LFO Phase Offset [degrees]** [+/-180]

When **Type** is set to **Common FX LFO 1** or **2**, this lets you offset the phase from the master LFO.

### OUTPUT

This is the standard effects output section, with modulatable control over wet/dry balance. For more information, see "OUTPUT" on page 890.

## 043: Multitap Cho/Delay 4Taps

This effect has four chorus blocks, each with a different LFO phase. You can create a complex stereo image by setting each block's delay time, depth, output level, and pan individually. You can also fix some of the chorus blocks to combine the chorus and delay effects.

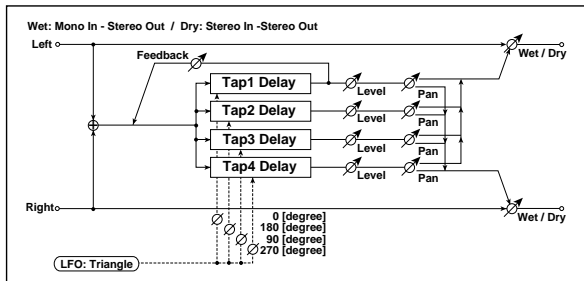

### MOD DELAY

#### Taps 1-4

There are four delay taps, each with separate settings for delay time, chorus depth, level, and pan. The chorus LFO phases are different for each tap:

- Tap 1 = 0 degrees
- Tap 2 = 180 degrees
- Tap 3 = 90 degrees
- Tap 4 = 270 degrees

**Tap 1...4 [msec]** [0...1000]

This sets the tap's delay time.

**Depth 1...4** [0...30]

This sets the tap's chorus depth.

**Level 1...4** [0...30]

This sets the tap's output level.

**Pan 1...4** [L6...L1, C, R1...R6]

This sets the tap's stereo position.

#### Tap 1 Feedback

**Tap 1 Feedback  $D_{mod}$**  [+/-100]

Sets the Tap1 feedback amount.

**Source** [Off...Tempo]

Selects the modulation source of Tap1 feedback amount and effect balance.

**Amount** [+/-100]

Sets the Tap1 feedback amount and modulation amount.

### LFO

**Frequency [Hz]** [0.02...13.00]

This sets the LFO speed, in Hz.

**LFO Type** [Individual, Common1, Common2]

This controls whether the effect uses its individual LFO, or one of the Common FX LFOs. For more information, see "LFO Type" on page 907.

**Common LFO Phase Ofs [deg]** [-180...+180]

When Type is set to **Common FX LFO 1** or **2**, this lets you offset the phase from the master LFO.

### OUTPUT

This is the standard effects output section, with modulatable control over wet/dry balance. For more information, see "OUTPUT" on page 890.

## 044: Multitap Cho/Delay 6Taps

This effect has six chorus blocks with different LFO phases. You can produce a complex stereo image by setting a different delay time and depth for each block. You can control the delay output level via a modulation source.

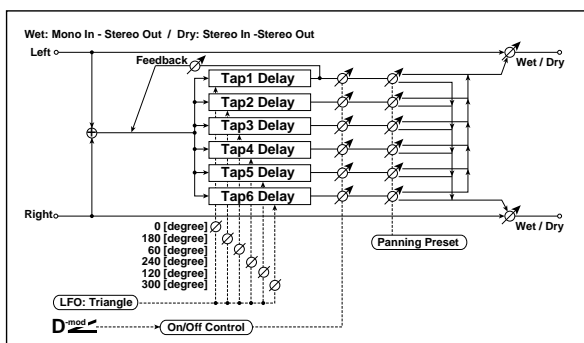

### MODULATION DELAY

#### Taps 1-6

There are six delay taps, each with separate settings for delay time, chorus depth, and on/off/modulation status. The chorus LFO phases are different for each tap:

- Tap 1 = 0 degrees
- Tap 2 = 180 degrees
- Tap 3 = 60 degrees
- Tap 4 = 240 degrees
- Tap 5 = 120 degrees
- Tap 6 = 300 degrees

**Tap 1...6 [msec]** [0...2000]

This sets the tap's delay time.

**Depth 1...6** [0...30]

This sets the tap's chorus depth.

**Status 1...6** [Always On, Always Off, On Off (Dmod), Off On (Dmod)]

This turns the tap on or off, or allows its output level to be modulated by the selected Dmod source.

**Always On:** Output is always on. (No modulation)

**Always Off:** Output is always off. (No modulation)

**On→Off (Dmod):** Output level fades from on to off via the modulation source.

**Off→On (Dmod):** Output level fades from off to on via the modulation source.

Combining these parameters, you can change from 4-phase chorus to two-tap delay by crossfading them gradually via the modulation source during a performance.

**Tap 1 Feedback**

**Tap1 Feedback**  $D_{mod}$  [+/-100]

Sets the amount of feedback from Tap1.

**Source** [Off...Tempo]

This selects a modulation source to modulate the tap output levels (as set by **Status**, above) and the **Tap 1 Feedback** amount.

**Amount** [+/-100]

Sets the modulation amount for the **Tap 1 Feedback**.

**Panning Preset** [1: L 1 2 3 4 5 6 R, 2: L 1 3 5 2 4 6 R, 3: L 1 3 5 2 4 6 R, 4: L 1 4 5 6 3 2 R]

This selects combinations of stereo panning patterns for the tap outputs.

**LFO**

**Frequency [Hz]** [0.02...13.00]

This sets the LFO speed, in Hz.

**OUTPUT**

This is the standard effects output section, with modulatable control over wet/dry balance. For more information, see "OUTPUT" on page 890.

**045: Bi Chorus**

This effect lets you place two independent chorus/flanger units in series or in parallel. If placed in series, feedback can be applied to the sound that has passed through the two chorus modules, creating even more complex modulation.

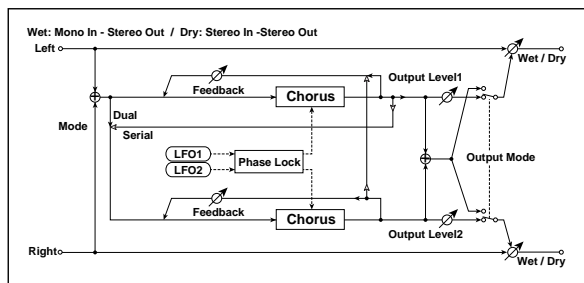

**CHORUS1**

**Manual** [0...100]

Sets the delay time for chorus 1.

**LFO1 Depth**  $D_{mod}$  [0...100]

Sets the LFO modulation depth for chorus 1.

**Source** [Off...Tempo]

Selects the modulation source that will control LFO modulation depth.

**Amount** [+/-100]

Sets the amount by which the chorus 1 LFO modulation depth will be controlled.

**Feedback** [0...100]

Sets the feedback amount for chorus 1.

**CHORUS2**

**Manual** [0...100]

Sets the delay time for chorus 2.

**LFO2 Depth**  $D_{mod}$  [0...100]

Sets the LFO modulation depth for chorus 2.

**Amount** [+/-100]

Sets the amount by which the chorus 2 LFO modulation depth will be controlled.

**Feedback** [0...100]

Sets the feedback amount for chorus 2. When **Routing** is set to Serial, this feeds back into Chorus 1, and Chorus 1's own **Feedback** setting is ignored.

**LFO1/2**

**LFO1/2 Lock** [Unlock, Lock-LFO1, Lock-Common1, Lock-Common2]

This selects the LFO(s) used by the two choruses.

**Unlock:** LFO 1 and LFO 2 will operate independently.

**Lock-LFO 1:** both choruses will use LFO 1, with an optional phase offset for LFO 2 (see "LFO2 Phase [degrees]," below).

**Lock-Common 1** or **Lock Common 2:** both choruses will use the selected FX Common LFO, with an optional phase offset for LFO 2.

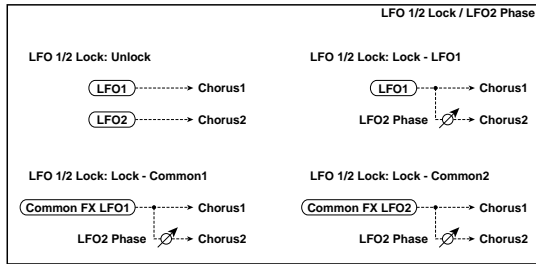

**LFO2 Phase [degrees]** [-180...+180]

Sets the phase difference between LFO1 and LFO2, when **LFO 1/2 Lock** is set to anything other than **Unlock**.

**LFO1 Frequency [Hz]** [0.02...20.00]

Sets the LFO 1 speed. This applies only if **LFO 1/2 Lock** is set to **Unlock** or **Lock-LFO1**.

**LFO2 Frequency [Hz]** [0.02...20.00]

Sets the LFO 2 speed. This applies only if **LFO 1/2 Lock** is set to **Unlock**.

**Source** [Off...Tempo]

Selects a source to modulate the speeds of LFO1 & 2.

**LFO1 Amount** [-20.00...+20.00]

This sets the **LFO1 Frequency** modulation amount, in Hz.

**LFO2 Amount** [-20.00...+20.00]

This sets the **LFO2 Frequency** modulation amount, in Hz.

**MIDI/Tempo Sync** [Check-box]

**BPM** [MIDI, 40.00...300.00]

**LFO1 Note** [Musical Note Icon]

**Times** [x1...x32]

**LFO2 Note** [Musical Note Icon]

**Times** [x1...x32]

When **MIDI/Tempo Sync** is on, the LFO speeds are set by **BPM**, **Note**, and **Times**, instead of **Frequency**. The two LFOs each have their own settings for **Note** and **Times**. For more information, see "MIDI/Tempo Sync" on page 907.

**MODE**

Chorus 1 and 2 are connected as shown in the diagram.

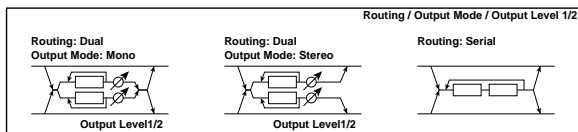

**Routing** [Dual, Serial]

Selects parallel or serial connection for chorus 1 and 2.

If **Routing** is set to **Serial**, the **Chorus 1 Output Level**, **Chorus 2 Output Level**, and **Chorus 2 Feedback** settings are ignored.

**Output Mode** [Mono, Stereo]

This applies only when **Routing** is set to **Dual**.

**Mono**: The outputs of both chorus 1 and 2 are summed together and panned to the center.

**Stereo**: Chorus 1 goes to the left output, and chorus 2 goes to the right output.

**Chorus1 Output Level** [0...100]

Sets the output level for chorus 1.

**Chorus2 Output Level** [0...100]

Sets the output level for chorus 2.

**OUTPUT**

This is the standard effects output section, with modulatable control over wet/dry balance. For more information, see "OUTPUT" on page 890.

## 046: Ensemble

This Ensemble effect has three chorus blocks that use LFO to create subtle shimmering, and gives three dimensional depth and spread to the sound, because the signal is output from the left, right, and center.

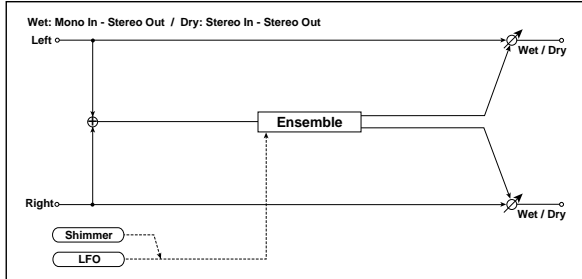

### ENSEMBLE

**Depth**  $D_{mod}$  [0...100]

Sets the depth of the LFO modulation.

**Source** [Off...Tempo]

Selects the modulation source for the LFO depth.

**Amount** [+/-100]

Sets the modulation amount of the LFO modulation depth.

### LFO

**Speed**  $D_{mod}$  [1...100]

Sets the LFO speed.

**Source** [Off...Tempo]

Selects a modulation source for LFO speed.

**Amount** [+/-100]

Sets the modulation amount of LFO speed.

**Shimmer** [0...100]

This parameter sets the amount of shimmering of the LFO waveform. Increasing this value adds more shimmering, making the chorus effect more complex and richer.

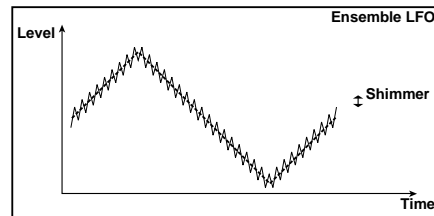

### OUTPUT

This is the standard effects output section, with modulatable control over wet/dry balance. For more information, see "OUTPUT" on page 890.

## 047: Polysix Ensemble

This models the ensemble effect built into the classic Korg PolySix programmable polyphonic synthesizer.

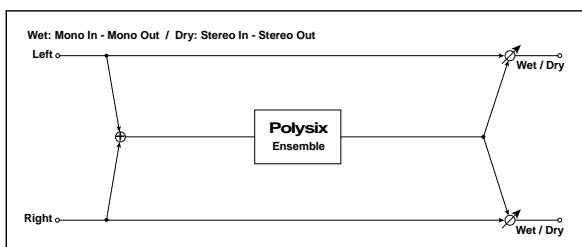

### POLYSIX ENSEMBLE

**Depth**  $D_{mod}$  [0...100]

Sets the depth of the effect.

**Source** [Off...Tempo]

Selects the modulation source that will control the effect depth.

**Amount** [+/-100]

Sets the amount by which the effect depth will be modulated.

### OUTPUT

This is the standard effects output section, with modulatable control over wet/dry balance. For more information, see "OUTPUT" on page 890.

## 048: Stereo Flanger

This effect gives a significant swell and movement of pitch to the sound. It is more effective when applied to a sound with a lot of harmonics. This is a stereo flanger. You can add spread to the sound by offsetting the phase of the left and right LFOs from each other.

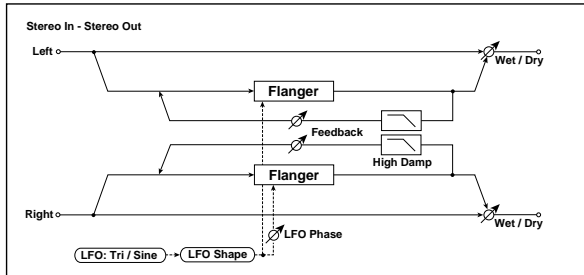

### FLANGER

**Delay Time [msec]** [0.0...50.0]

Sets the delay time from the original sound.

**Depth** [0...100]

Sets the depth of LFO modulation.

**Feedback** [+/-100]

This controls the intensity of the flanger effect. Positive and negative values create different timbres.

Mixing the processed and dry signals via **Wet/Dry** will enhance the effect. For maximum intensity, set **Feedback** and **Wet/Dry** so that they are either both positive or both negative; this emphasizes the flanger's harmonic peaks.

**High Damp [%]** [0...100]

This sets the amount of high-frequency attenuation in the flanger's feedback loop. Increasing the value will reduce high-frequency harmonics.

### LFO

**Waveform** [Triangle, Sine]

Selects the LFO Waveform.

**Shape** [+/-100]

Changes the curvature of the LFO Waveform. p.910.

**Phase [degrees]** [-180...+180]

Sets the LFO phase difference between the left and right. See "Phase [degrees]" on page 909.

**Frequency [Hz]** D<sub>mod</sub> [0.02...20.00]

This sets the LFO speed, in Hz. It applies only when **MIDI/Tempo Sync**, below, is **Off**.

**Source** [Off...Tempo]

This selects a modulation source for the **Frequency**.

**Amount** [-20.00...+20.00]

This sets the **Frequency** modulation amount, in Hz.

**MIDI/Tempo Sync** D<sub>mod</sub> [Check-box]

**BPM** [MIDI, 40.00...300.00]

**Base Note** [♪...♩]

**Times** [x1...x32]

When **MIDI/Tempo Sync** is on, the LFO speed is set by **BPM**, **Base Note**, and **Times**, instead of **Frequency**. For more information, see "MIDI/Tempo Sync" on page 907.

**Type** [Individual, Common1, Common2]

This controls whether the effect uses its individual LFO, or one of the Common FX LFOs. For more information, see "LFO Type" on page 907.

**Common LFO Phase Offset [degrees]** [+/-180]

When **Type** is set to **Common FX LFO 1** or **2**, this lets you offset the phase from the master LFO.

### OUTPUT

**Wet/Dry** D<sub>mod</sub> [-Wet...-1:99, Dry, 1:99...Wet]

Sets the balance between the "wet" processed sound and the dry input. Negative values invert the phase of the wet signal. This interacts with **Feedback**; for more information, see "Feedback" on page 934.

**Source** [Off...Tempo]

Selects a modulation source for **Wet/Dry**.

**Amount** [+/-100]

Sets the modulation amount for **Wet/Dry**.

## 049: Stereo Random Flanger

The stereo effect uses a step-shape waveform and random LFO for modulation, creating a unique flanging effect.

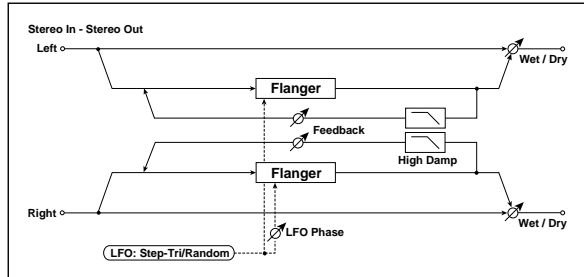

### FLANGER

**Delay Time [msec]** [0.0...50.0]

Sets the delay time from the original sound.

**Depth** [0...100]

Sets the depth of LFO modulation.

**Feedback** [+/-100]

This controls the intensity of the flanger. For more information, see “Feedback” on page 934.

**High Damp [%]** [0...100]

This sets the amount of high-frequency attenuation in the flanger’s feedback loop. Increasing the value will reduce high-frequency harmonics.

### LFO

These parameters control the shape and speed of the step LFO. They are identical to those in the Stereo Random Filter; for more information, see “LFO” on page 909.

### OUTPUT

**Wet/Dry** [-Wet...-1:99, Dry, 1: 99...Wet]

Sets the balance between the “wet” processed sound and the dry input. Negative values invert the phase of the wet signal. This interacts with **Feedback**; for more information, see “Feedback” on page 934.

**Source** [Off...Tempo]

Selects a modulation source for Wet/Dry.

**Amount** [+/-100]

Sets the modulation amount for Wet/Dry.

## 050: Stereo Envelope Flanger

This Flanger uses a MIDI-triggerable envelope generator for modulation. This lets you create sequences with flanger sweeps which always happen on the same beat, for instance. You can also control the Flanger directly using a modulation source.

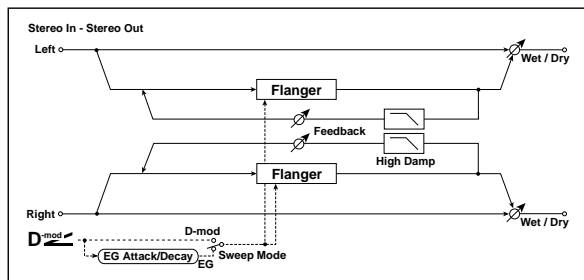

### CONTROL

**Sweep Mode** [EG, Dmod]

When **Sweep Mode** is set to EG, the envelope generator controls the flanger. Note that this is the effect’s own EG, and isn’t related to the Program’s other EGs (Filter, Amp, etc.).

The **Source** parameter, below, selects the source that starts the envelope generator. If you select Gate, for example, the envelope will be triggered by note-ons.

The EG is triggered when the MIDI source’s value changes from 63 or smaller to 64 or higher.

When **Sweep Mode** is set to **Dmod**, the modulation source directly controls the flanger. Select the modulation source using the **Source** parameter, below.

**Source** [Off...Tempo]

Selects the modulation source that triggers the EG (when **Sweep Mode** = EG), or the modulation source that causes the flanger to sweep (when **Sweep Mode** = Dmod).

### EG

**Attack** [1...100]

Sets the EG attack time. For more information Attack and Release, see the graphic under “Attack [msec]” on page 892.

**Decay** [1...100]

Sets the EG decay time.

### FLANGER

**L Delay Bottom [msec]** [0.0...50.0]

Sets the lower limit of the left-channel delay time. For more information on the Bottom and Top settings, see the graphic under “Frequency Bottom” on page 907.

**L Delay Top [msec]** [0.0...50.0]

Sets the upper limit of the left-channel delay time.



**R Delay Bottom [msec]** [0.0...50.0]

Sets the lower limit of the right-channel delay time.

**R Delay Top [msec]** [0.0...50.0]

Sets the upper limit of the right-channel delay time.

**Feedback** [+/-100]

This controls the intensity of the flanger. For more information, see "Feedback" on page 934.

**High Damp [%]** [0...100]

This sets the amount of high-frequency attenuation in the flanger's feedback loop. Increasing the value will reduce high-frequency harmonics.

## 051: Stereo Phaser

This effect creates a swell by shifting the phase. It is very effective on electric piano sounds. You can add spread to the sound by offsetting the phase of the left and right LFOs from each other

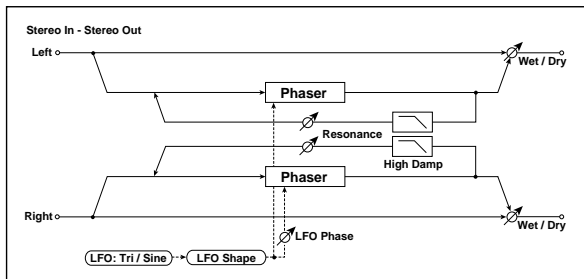

### PHASER

**Manual** [0...100]

Sets the phaser's center frequency.

**Depth** D<sub>mod</sub> [0...100]

Sets the depth of LFO modulation.

**Source** [Off...Tempo]

Selects the modulation source for the LFO modulation depth.

**Amount** [+/-100]

Sets the modulation amount of the LFO modulation depth.

**Resonance** [+/-100]

This controls the intensity of the phaser effect. Positive and negative values create different timbres.

Mixing the processed and dry signals via **Wet/Dry** will enhance the effect. For maximum intensity, set **Resonance** and **Wet/Dry** so that they are either both positive or both negative; this emphasizes the phaser's harmonic peaks.

**High Damp [%]** [0...100]

This sets the amount of high-frequency attenuation in the phaser's feedback loop. Increasing the value will reduce high-frequency harmonics.

### OUTPUT

**Wet/Dry** D<sub>mod</sub> [-Wet...-1:99, Dry, 1: 99...Wet]

Sets the balance between the "wet" processed sound and the dry input. Negative values invert the phase of the wet signal. This interacts with **Feedback**; for more information, see "Feedback" on page 934.

**Source** [Off...Tempo]

Selects a modulation source for Wet/Dry.

**Amount** [+/-100]

Sets the modulation amount for Wet/Dry.

### LFO

**Waveform** [Triangle, Sine]

Selects the LFO Waveform.

**Shape** [+/-100]

Changes the curvature of the LFO Waveform. p.910.

**Phase [degrees]** [-180...+180]

Sets the LFO phase difference between the left and right. See "Phase [degrees]" on page 909.

**Frequency [Hz]** D<sub>mod</sub> [0.02...20.00]

This sets the LFO speed, in Hz. It applies only when **MIDI/Tempo Sync**, below, is **Off**.

**Source** [Off...Tempo]

This selects a modulation source for the **Frequency**.

**Amount** [-20.00...+20.00]

This sets the **Frequency** modulation amount, in Hz.

**MIDI/Tempo Sync** D<sub>mod</sub> [Check-box]

**BPM** [MIDI, 40.00...300.00]

**Base Note** [♪...♩]

**Times** [x1...x32]

When **MIDI/Tempo Sync** is on, the LFO speed is set by **BPM**, **Base Note**, and **Times**, instead of **Frequency**. For more information, see "MIDI/Tempo Sync" on page 907.

**Type** [Individual, Common1, Common2]

This controls whether the effect uses its individual LFO, or one of the Common FX LFOs. For more information, see "LFO Type" on page 907.

**Common LFO Phase Offset [degrees]** [+/-180]

When **Type** is set to **Common FX LFO 1** or **2**, this lets you offset the phase from the master LFO.

## OUTPUT

**Wet/Dry**  [-Wet...-1:99, Dry, 1: 99...Wet]

Sets the balance between the “wet” processed sound and the dry input. Negative values invert the phase of the wet signal. This interacts with **Resonance**; for more information, see “Resonance” on page 936.

## 052: Stereo Random Phaser

This is a stereo phaser. The effect uses a step-shape waveform and random LFO for modulation, creating a unique phasing effect.

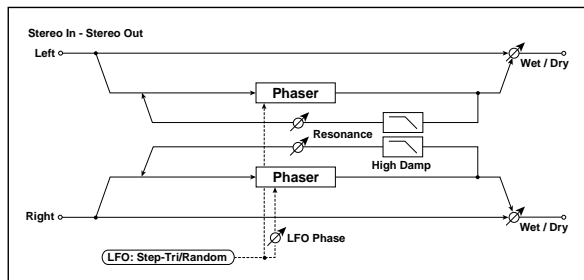

## PHASER

**Manual** [0...100]

Sets the frequency to which the effect is applied.

**Depth** [0...100]

Sets the depth of LFO modulation.

**Resonance** [+/-100]

This controls the intensity of the phaser. For more information, see “Resonance” on page 936.

**High Damp [%]** [0...100]

This sets the amount of high-frequency attenuation in the phaser’s feedback loop. Increasing the value will reduce high-frequency harmonics.

## LFO

**Waveform** [Step-Tri, Step-Sin, Random]

Selects the LFO Waveform. For more information, see “Waveform” on page 909.

**Phase [degrees]** [-180...+180]

Sets the LFO phase difference between the left and right. See “Phase [degrees]” on page 909.

**Frequency [Hz]**  [0.02...20.00]

**Step Frequency [Hz]**  [0.05...50.00]

**Source** [Off...Tempo]

**Amount** [-20.00...+20.00]

**Step Amount** [-50.00...+50.00]

These parameters control the speed of the LFO when **MIDI/Tempo Sync** is **Off**. For more information, see “Frequency” on page 909.

**Source** [Off...Tempo]

Selects a modulation source for Wet/Dry.

**Amount** [+/-100]

Sets the modulation amount for Wet/Dry.

**MIDI/Tempo Sync**  [Check-box]

**BPM** [MIDI, 40.00...300.00]

**Base Note**  [♩... ♪]

**Times** [x1...x32]

**Step Note**  [♩... ♪]

**Times** [x1...x32]

These parameters control the speed of the LFO when **MIDI/Tempo Sync** is **On**. For more information, see “Frequency” on page 909.

**Type (Step)** [Individual, Common1, Common2]

**Common LFO Phase Offset [degrees]** [+/-180]

These parameters control the LFO source for the steps; they do not affect the triangle or sine LFOs. For more information, see “Step LFO type” on page 910.

## OUTPUT

**Wet/Dry**  [-Wet...-1:99, Dry, 1: 99...Wet]

Sets the balance between the “wet” processed sound and the dry input. Negative values invert the phase of the wet signal. This interacts with **Resonance**; for more information, see “Resonance” on page 936.

**Source** [Off...Tempo]

Selects a modulation source for Wet/Dry.

**Amount** [+/-100]

Sets the modulation amount for Wet/Dry.

## 053: Stereo Envelope Phaser

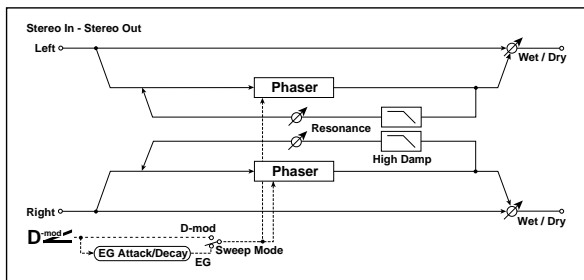

This stereo phaser uses an envelope generator for modulation. You will obtain the same pattern of phasing each time you play. You can also control the Phaser directly using the modulation source.

### PHASER

#### L Manual Bottom [0...100]

Sets the lower limit of the left-channel phaser's sweep.

For more information on the Bottom and Top settings, see the graphic under "Frequency Bottom" on page 907.

#### L Manual Top [0...100]

Sets the upper limit of the left-channel phaser's sweep.

#### R Manual Bottom [0...100]

Sets the lower limit of the right-channel phaser's sweep.

#### R Manual Top [0...100]

Sets the upper limit of the right-channel phaser's sweep.

### CONTROL

#### Sweep Mode [EG, Dmod]

Determines whether the phaser is controlled by the envelope generator or by the modulation source. For more information, see "Sweep Mode" on page 935.

#### Source $D_{mod}$ [Off...Tempo]

Selects the modulation source that triggers the EG (when EG is selected for Sweep Mode), or modulation source that causes the phaser to sweep (when Dmod is selected for Sweep Mode). For more information, see "Source" on page 935.

### EG

#### Attack [1...100]

Sets the EG attack time. For more information Attack and Release, see the graphic under "Attack [msec]" on page 892.

#### Decay [1...100]

Sets the EG decay time.

### PHASER

#### Resonance [+/-100]

This controls the intensity of the phaser. For more information, see "Resonance" on page 936.

#### High Damp [%] [0...100]

This sets the amount of high-frequency attenuation in the phaser's feedback loop. Increasing the value will cut high-range harmonics.

### OUTPUT

#### Wet/Dry $D_{mod}$ [-Wet...-1:99, Dry, 1: 99...Wet]

Sets the balance between the "wet" processed sound and the dry input. Negative values invert the phase of the wet signal. This interacts with **Resonance**; for more information, see "Resonance" on page 936.

#### Source [Off...Tempo]

Selects a modulation source for Wet/Dry.

#### Amount [+/-100]

Sets the modulation amount for Wet/Dry.

## 054: Bi Phaser

This effect provides two independent phasers that can be connected in series or in parallel.

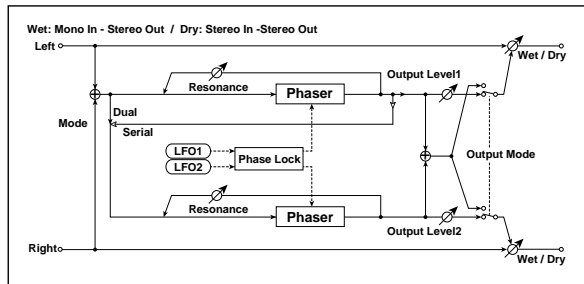

### PHASER1

**Manual** [0...100]

Sets the frequency of phaser 1.

**LFO1 Depth**  $D_{mod}$  [0...100]

Sets the LFO modulation depth of phaser 1.

**Source** [Off...Tempo]

Selects a source to control LFO modulation depth of both phasers.

**Amount** [+/-100]

Sets the amount by which the phaser 1 LFO modulation depth will be controlled.

**Resonance** [0...100]

This controls the intensity of Phaser 1. For more information, see "Resonance" on page 936.

### PHASER2

**Manual** [0...100]

Sets the frequency of phaser 2.

**LFO2 Depth**  $D_{mod}$  [0...100]

Sets the LFO modulation depth of phaser 2.

**Amount** [+/-100]

Sets the amount by which the phaser 2 LFO modulation depth will be controlled.

**Resonance** [0...100]

This controls the intensity of Phaser 1. For more information, see "Resonance" on page 936.

### LFO1/2

These are the parameters for the two LFOs, which are identical to those in the Bi Chorus effect. For more information, see "LFO1/2" on page 931.

### MODE

**Routing** [Dual, Serial]

Selects whether the phasers are connected in parallel or in series. If **Routing** is set to **Serial**, the **Phaser 1 Output Level** and **Phaser 2 Output Level** settings are ignored.

**Output Mode** [Mono, Stereo]

Selects whether phaser 1 and 2 will be routed separately to the left and right channels, or summed to mono.

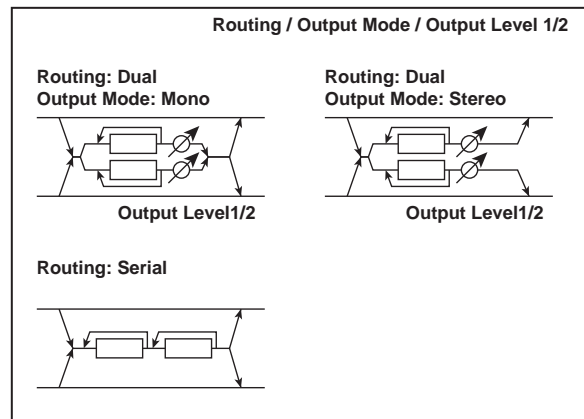

**Phaser1 Output Level** [0...100]

Sets the output level for phaser 1. This applies only if **Routing** is set to **Dual**.

**Phaser2 Output Level** [0...100]

Sets the output level for phaser 2. This applies only if **Routing** is set to **Dual**.

### OUTPUT

**Wet/Dry**  $D_{mod}$  [-Wet...-1:99, Dry, 1: 99...Wet]

Sets the balance between the "wet" processed sound and the dry input. Negative values invert the phase of the wet signal. This interacts with **Resonance**; for more information, see "Resonance" on page 936.

**Source** [Off...Tempo]

Selects a modulation source for Wet/Dry.

**Amount** [+/-100]

Sets the modulation amount for Wet/Dry.

## Modulation and Pitch Shift

### 055: Stereo Vibrato

This effect modulates the pitch of the input signal to create a shimmering timbre. AutoFade allows you to increase or decrease the vibrato speed.

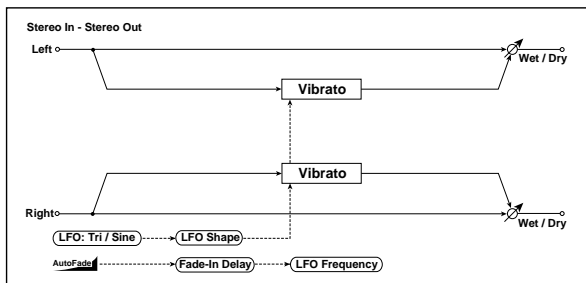

#### AUTOFADE

Autofade lets you modulate the LFO Frequency via a simple envelope, triggered by a Dmod source. This is enabled by setting **LFO Frequency Mod** to **AUTOFADE**, and can only be used when **BPM/Tempo Sync** is **Off**.

The intensity of the autofade's effect is controlled by the normal **Amount** parameter, under **Frequency**.

#### Autofade example

The diagram below shows a setup with note-ons triggering the autofade, causing the LFO to speed up from 1.0Hz to 4.0Hz.

The **AUTOFADE Source** is set to **Gate1**, **LFO Frequency Mod** is set to **AUTOFADE**, **LFO Frequency [Hz]** is set to **1.0**, and the modulation **Amount** is set to **3.0**.

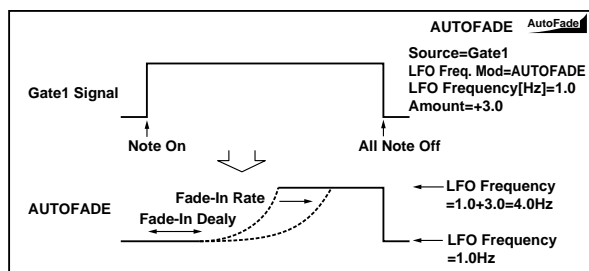

#### Source D<sub>mod</sub> [Off...Tempo]

Selects the trigger source for the Autofade.

Autofade is triggered when the Dmod value changes from 63 or smaller to 64 or higher, and turns off again when the Dmod value goes below 64.

#### Rate [1...100]

Sets the speed of the fade-in. Higher values are faster.

#### Fade-In Delay [msec] [00...2000]

This sets the time from the trigger source turning on (going above a value of 63) until the fade-in starts.

#### LFO Frequency Mod [Dmod, AUTOFADE]

This selects whether the LFO will be modulated by the normal Frequency Dmod source, or by the Autofade envelope.

#### VIBRATO

#### Depth D<sub>mod</sub> [0...100]

Sets the depth of LFO modulation

#### Source [Off...Tempo]

Selects the modulation source of the LFO modulation depth.

#### Amount [+/-100]

Sets the modulation amount of the LFO modulation depth.

#### LFO

#### Waveform [Triangle, Sine]

Selects the LFO Waveform.

#### Shape [+/-100]

Changes the curvature of the LFO Waveform. For more information, see "Shape" on page 910.

#### Frequency [Hz] D<sub>mod</sub> [0.02...20.00]

This sets the LFO speed, in Hz. It applies only when **MIDI/Tempo Sync**, below, is **Off**.

#### Source [Off...Tempo]

This selects a modulation source for the **Frequency**.

#### Amount [-20.00...+20.00]

This sets the **Frequency** modulation amount, in Hz.

#### MIDI/Tempo Sync D<sub>mod</sub> [Check-box]

#### BPM [MIDI, 40.00...300.00]

#### Base Note [♩...]

#### Times [x1...x32]

When **MIDI/Tempo Sync** is on, the LFO speed is set by **BPM**, **Base Note**, and **Times**, instead of **Frequency**. For more information, see "MIDI/Tempo Sync" on page 907.

#### Type [Individual, Common1, Common2]

This controls whether the effect uses its individual LFO, or one of the Common FX LFOs. For more information, see "LFO Type" on page 907.

#### Common LFO Phase Offset [degrees] [+/-180]

When **Type** is set to **Common FX LFO 1** or **2**, this lets you offset the phase from the master LFO.

## OUTPUT

This is the standard effects output section, with modulatable control over wet/dry balance. For more information, see “OUTPUT” on page 890.

## 056: Stereo Auto Fade Mod.

This stereo chorus/flanger effect enables you to control the LFO speed and effect balance using auto fade, and you can spread the sound by offsetting the phase of the left and right LFOs from each other.

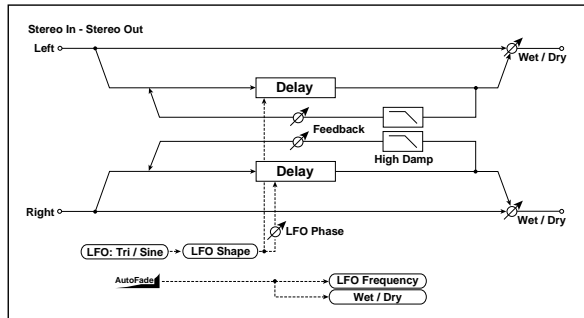

## AUTOFADE

For more information on the Autofade parameters, see “AUTOFADE” on page 940.

**Source** [Off...Tempo]  
Selects the modulation source that starts AutoFade.

**Rate** [1...100]  
Sets the rate of fade-in.

**Fade-In Delay [msec]** [00...2000]  
Sets the fade-in delay time.

**LFO Frequency Mod** [Dmod, AUTOFADE]  
Switches between D-mod and AUTOFADE for the LFO frequency modulation.

**Wet/Dry Mod** [Dmod, AUTOFADE]  
Switches between D-mod and AUTOFADE for the effect balance modulation.

## MOD DELAY

**L Delay Time [msec]** [0.0...500.0]  
Sets the left channel delay time.

**R Delay Time [msec]** [0.0...500.0]  
Sets the right channel delay time.

**Depth** [0...200]  
Sets the depth of LFO modulation.

**Feedback** [+/-100]  
Sets the feedback amount. See “Feedback” on page 928.

**High Damp [%]** [0...100]  
Sets the amount of high-frequency attenuation for the feedback path.

## LFO

**Waveform** [Triangle, Sine]  
Selects the LFO Waveform.

**Shape** [+/-100]  
Changes the curvature of the LFO Waveform. For more information, see “Shape” on page 910.

**Phase [degrees]** [-40...+40]  
Sets the LFO phase difference between the left and right. See “Phase [degrees]” on page 909.

**Frequency [Hz]** [0.02...20.00]  
This sets the LFO speed, in Hz.

**Source** [Off...Tempo]  
This selects a modulation source for the Frequency.

**Amount** [-20.00...+20.00]  
This sets the Frequency modulation amount, in Hz.

**Type** [Individual, Common1, Common2]  
This controls whether the effect uses its individual LFO, or one of the Common FX LFOs. For more information, see “LFO Type” on page 907.

**Common LFO Phase Offset [degrees]** [+/-180]  
When Type is set to **Common FX LFO 1** or **2**, this lets you offset the phase from the master LFO.

## OUTPUT

This is the standard effects output section, with modulatable control over wet/dry balance. For more information, see “OUTPUT” on page 890.

## 057: 2-Voice Resonator

This effect includes two independent resonators, which each resonate at a specified pitch in response to the input signal. You can use this to add a unique character to a string sound by emphasizing certain harmonics, for instance, or to introduce a pitched element into a drum loop. The resonance intensity can be controlled via an LFO or Dmod.

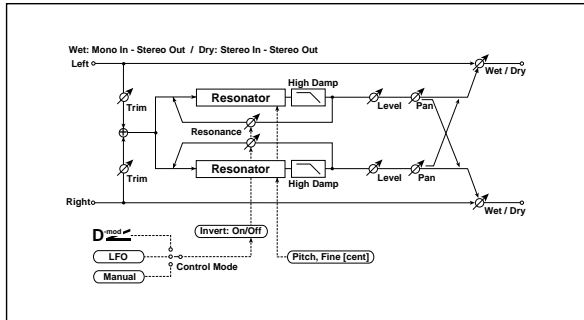

### CONTROL

**Trim** [0...100]

This sets the input level for the effect.

**Control Mode** [Manual, LFO, Dmod]

This sets the way that the Resonance is controlled.

**Manual:** the **Resonance** parameter controls the intensity of the effect.

**LFO:** the intensity of resonance is controlled by the LFO. As the LFO sways between positive and negative values, the resonators alternate between octaves of the specified pitch.

**Dmod:** the resonance is controlled by the dynamic modulation source. If you use a bipolar modulation source, such as JS X or Ribbon, you can modulate the resonance so that the resonance sounds in both the high and low octaves, similar to the LFO.

**LFO/Dmod Invert** [Check-box]

This applies only when **Control Mode** is set to **LFO** or **Dmod**.

Enabling **LFO/Dmod Invert** reverses the **Resonance** modulation for Voice 2. As the Dmod or LFO increases, Voice 1's Resonance will be positive, but Voice 2's will be negative (and thus resonate at the lower octave).

**Source** <sup>Dmod</sup> [Off...Tempo]

Selects a modulation source to control **Resonance** intensity.

**Modulation Depth** [+/-100]

Sets the amount of resonance intensity modulation. This applies to both LFO and Dmod.

### LFO

**Frequency [Hz]** <sup>Dmod</sup> [0.02...20.00]

This sets the LFO speed, in Hz. It applies only when **MIDI/Tempo Sync**, below, is **Off**.

**MIDI/Tempo Sync** <sup>Dmod</sup> [Check-box]

**BPM** [MIDI, 40.00...300.00]

**Base Note** [Musical Note Icon...]

**Times** [x1...x32]

When **MIDI/Tempo Sync** is on, the LFO speed is set by **BPM**, **Base Note**, and **Times**, instead of **Frequency**. For more information, see "MIDI/Tempo Sync" on page 907.

**Type** [Individual, Common1, Common2]

Selects either (individual) LFO, Common FX LFO1, or Common LFO2. See "LFO Type" on page 907.

**Common LFO Phase Offset [degrees]** [-180...+180]

Sets the phase offset when Type = Common 1 or Common 2. See "Common LFO Phase Offset [degrees]" on page 907.

### VOICE1

**Pitch** [C0...B8]

This sets the tuning of Voice 1, by note name.

**Fine [cents]** [-50...+50]

This adjusts the fine-tuning of Voice 1, in cents.

**Resonance** [ +/-100]

This applies only when **Control Mode** is set to **Manual**.

Negative settings change the harmonic content, and also make the resonance one octave lower.

**High Damp [%]** [0...100]

This sets the amount of damping for the high frequencies of the resonant sound. Lower values mean less damping, creating a metallic sound with stronger harmonics.

**Level** [0...100]

This sets the output level for Voice 1.

**Pan** [L6...L1, C, R1...R6]

This sets the stereo position of Voice1.

### VOICE2

The parameters for Voice 2 are the same as those for "VOICE1," above.

### OUTPUT

This is the standard effects output section, with modulatable control over wet/dry balance. For more information, see "OUTPUT" on page 890.



## 058: Doppler

This effect simulates the “Doppler effect” of a moving sound with a changing pitch, like the siren of a passing ambulance. Mixing the effect sound with the dry sound will create a unique chorus effect.

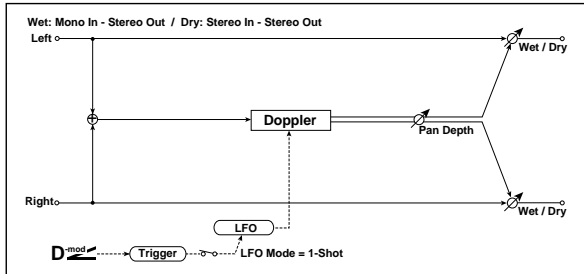

### DOPPLER

**Pitch Depth** D<sup>mod</sup> [0...100]

With the Doppler effect, the pitch is raised as the sound approaches, and the pitch is lowered as the sound goes away. This parameter controls the amount of this pitch variation.

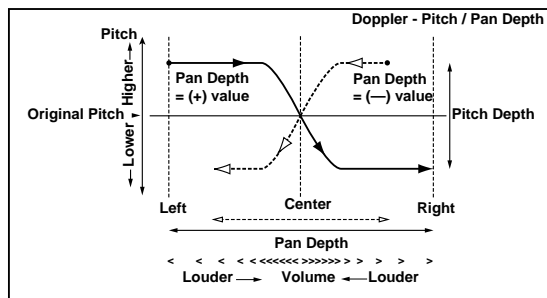

**Source** [Off...Tempo]

Selects the modulation source of pitch variation.

**Amount** [+/-100]

Sets the modulation amount of pitch variation.

**Pan Depth** D<sup>mod</sup> [+/-100]

This sets the width of the stereo image of the effect sound. With larger values, the sound seems to come and go from much further away. With positive values, the sound moves from left to right; with negative values, it moves from right to left.

**Source** [Off...Tempo]

Selects the modulation source of panning.

**Amount** [+/-100]

Sets the modulation amount of panning.

### LFO

**Mode** [Loop, 1-Shot]

This selects whether the Doppler effect repeats continuously (**Loop**), or cycles once and then stops (**1-Shot**).

When **Mode** is set to **Loop**, and **Dmod Sync** is set to **On**, you can reset the LFO via Dmod (as specified by the **Source** parameter, below).

When **Mode** is set to **1-Shot**, the Doppler effect happens only once when triggered, and then stops until it is triggered again. The trigger source is specified by the **Source** parameter, below. Note that this requires you to manually trigger the effect; otherwise, you won't hear the Doppler at all.

**Dmod Sync** [Check-box]

When this is **On**, and **Mode** is set to **Loop**, you can reset the LFO via Dmod (as specified by the **Source** parameter, below).

**Source** D<sup>mod</sup> [Off...Tempo]

Selects the LFO reset modulation source.

**MIDI** The effect is triggered when the MIDI value changes from 63 or smaller to 64 or higher.

**Frequency [Hz]** D<sup>mod</sup> [0.02...20.00]

This sets the LFO speed, in Hz. It applies only when **MIDI/Tempo Sync**, below, is **Off**.

**Source** [Off...Tempo]

This selects a modulation source for the **Frequency**.

**Amount** [-20.00...+20.00]

This sets the **Frequency** modulation amount, in Hz.

**MIDI/Tempo Sync** D<sup>mod</sup> [Check-box]

**BPM** [MIDI, 40.00...300.00]

**Base Note** [♪...♩]

**Times** [x1...x32]

When **MIDI/Tempo Sync** is on, the LFO speed is set by **BPM**, **Base Note**, and **Times**, instead of **Frequency**. For more information, see “MIDI/Tempo Sync” on page 907.

**Type** [Individual, Common1, Common2]

This controls whether the effect uses its individual LFO, or one of the Common FX LFOs. For more information, see “LFO Type” on page 907.

**Common LFO Phase Offset [degrees]** [+/-180]

When **Type** is set to **Common FX LFO 1** or **2**, this lets you offset the phase from the master LFO.

### OUTPUT

This is the standard effects output section, with modulatable control over wet/dry balance. For more information, see “OUTPUT” on page 890.

## 059: Scratch

This effect simulates the sound of scratching on a turntable, by recording the input and then modulating the playback.

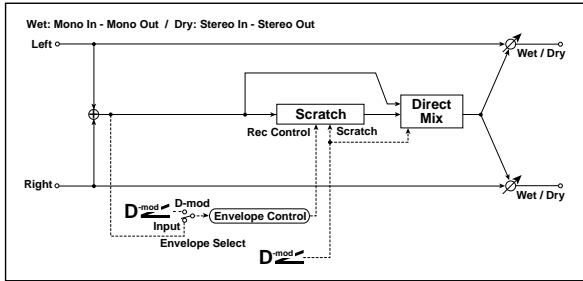

### RECORD

#### Envelope Select [Dmod, Input]

Selects whether the start and end of recording is controlled via the modulation source or the input signal level.

**Dmod:** the input signal will be recorded only when the modulation value is 64 or higher.

**Input:** the input signal will be recorded only when its level is over the **Threshold** value.

The maximum recording time is 2,730msec. If this is exceeded, the recorded data will start being erased from the top.

#### Source [Off...Tempo]

Selects the modulation source that controls recording when **Envelope Select** is set to Dmod.

#### Threshold [0...100]

Sets the recording start level when **Envelope Select** is set to Input.

#### Response [0...100]

This sets the speed of the response to the end of recording. Set a smaller value when you are recording a phrase or rhythm pattern, and set a higher value if you are recording only one note.

### PLAYBACK

#### Scratch Source [Off...Tempo]

This selects the modulation source for the "scratch." The modulation value corresponds to the playback position.

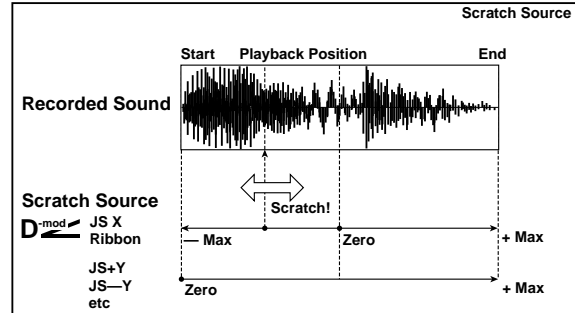

#### Response [0...100]

This controls how fast the effect responds to the **Scratch Source**.

#### Direct Mix [Always On, Always Off, Cross Fade]

This controls how the dry sound is mixed with the effected sound. To use this parameter effectively, set **Wet/Dry** to Wet.

**Always On:** The dry sound is always heard at the output, and the scratch effect is layered on top.

**Always Off:** Only the scratch effect is heard at the output. If you're not scratching, there won't be any sound.

**Cross Fade:** Normally, the dry sound is heard at the output. When you start to scratch, the dry sound is muted; when you stop scratching, the dry sound reappears.

### OUTPUT

This is the standard effects output section, with modulatable control over wet/dry balance. For more information, see "OUTPUT" on page 890.

## 060: Grain Shifter

This effect cuts extremely short samples ("grains") from the input signal waveform and plays them repeatedly, giving a mechanical character to the sound.

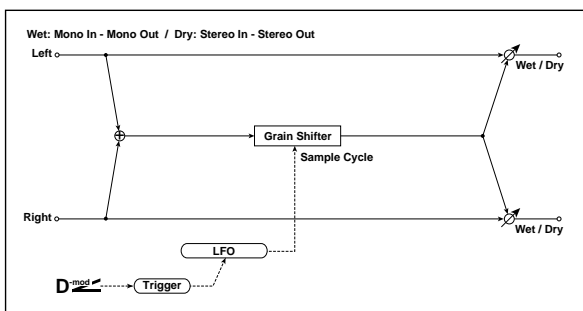

### GRAIN SHIFTER

#### Duration [0...100]

**Duration** sets the length of the sampled grain, and the **LFO Sample Cycle** controls how often a new grain is sampled. In between Sample Cycles, the current grain is repeated continuously.

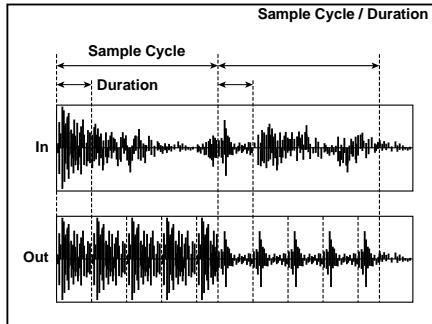

**Source** [Off...Tempo]

Selects the source that will modulate the duration of the grain.

**Amount** [+/-100]

Sets the amount by which the grain duration will be modulated.

**LFO**

**Sync Source** [Off...Tempo]

Selects the modulation source that will reset the LFO.

**Sample Cycle [Hz]** [0.02...20.00]

Sets the frequency at which the grain will be switched. For more information, see "Duration," above.

**Source** [Off...Tempo]

Selects a modulation source for LFO speed.

**Amount** [-20.00...+20.00]

Sets the modulation amount of LFO speed.

**MIDI/Tempo Sync** [Check-box]

**BPM** [MIDI, 40.00...300.00]

**Base Note** [Musical Notation]

**Times** [x1...x32]

When **MIDI/Tempo Sync** is on, the LFO speed is set by **BPM**, **Base Note**, and **Times**, instead of **Frequency**. For more information, see "MIDI/Tempo Sync" on page 907.

**Type** [Individual, Common1, Common2]

This controls whether the effect uses its individual LFO, or one of the Common FX LFOs. For more information, see "LFO Type" on page 907.

**Common LFO Phase Offset [degrees]** [+/-180]

When **Type** is set to **Common FX LFO 1** or **2**, this lets you offset the phase from the master LFO.

**OUTPUT**

This is the standard effects output section, with modulatable control over wet/dry balance. For more information, see "OUTPUT" on page 890.

**061: Stereo Tremolo**

This effect modulates the volume level of the input signal. The effect is stereo, and offsetting the LFO of the left and right phases from each other produces a tremolo effect between left and right.

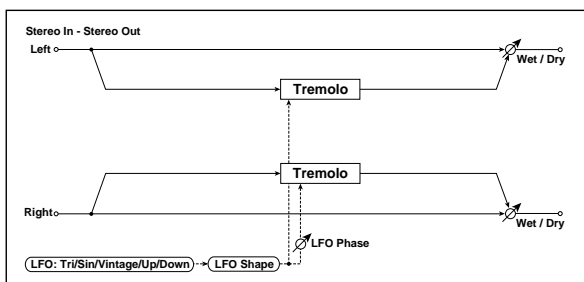

**LFO**

**Waveform** [Triangle, Sine, Vintage, Up, Down]

This parameter sets the basic shape of the LFO. The **Vintage** waveform models classic guitar-amp tremolo.

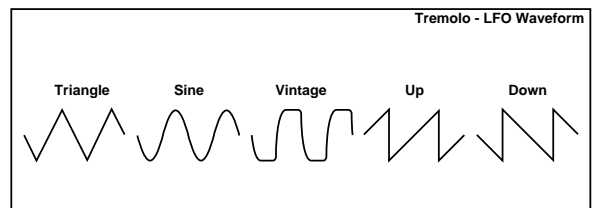

**Shape** [+/-100]

Changes the curvature of the LFO Waveform. p.910.

**Phase [degrees]** [-180...+180]

This parameter determines the difference between the left and right LFO phases. Higher values create an auto-pan effect, the sound moving between left and right.

**Frequency [Hz]** [0.02...20.00]

This sets the LFO speed, in Hz. It applies only when **MIDI/Tempo Sync**, below, is **Off**.

**Source** [Off...Tempo]

This selects a modulation source for the **Frequency**.

**TREMOLO**

**Depth** [0...100]

Sets the depth of LFO modulation.

**Source** [Off...Tempo]

Selects the modulation source of the depth of modulation.

**Amount** [+/-100]

Sets the modulation amount of the depth of modulation.

**Amount** [-20.00...+20.00]

This sets the **Frequency** modulation amount, in Hz.

**MIDI/Tempo Sync**  [Check-box]

**BPM** [MIDI, 40.00...300.00]

**Base Note**  ... ]

**Times** [x1...x32]

When **MIDI/Tempo Sync** is on, the LFO speed is set by **BPM**, **Base Note**, and **Times**, instead of **Frequency**. For more information, see “MIDI/Tempo Sync” on page 907.

**Type** [Individual, Common1, Common2]

This controls whether the effect uses its individual LFO, or one of the Common FX LFOs. For more information, see “LFO Type” on page 907.

**Common LFO Phase Offset [degrees]** [+/-180]

When **Type** is set to **Common FX LFO 1** or **2**, this lets you offset the phase from the master LFO.

**OUTPUT**

This is the standard effects output section, with modulatable control over wet/dry balance. For more information, see “OUTPUT” on page 890.

**062: Stereo Envelope Tremolo**

This effect uses the input signal level to modulate a stereo tremolo (LFO volume modulation). For instance, you can create a tremolo effect that becomes deeper and faster as the input gets more quiet.

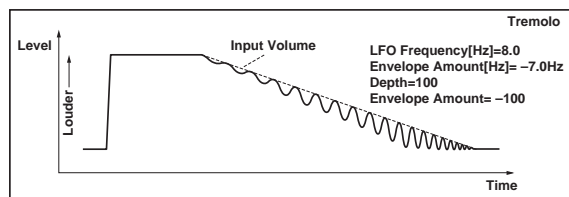
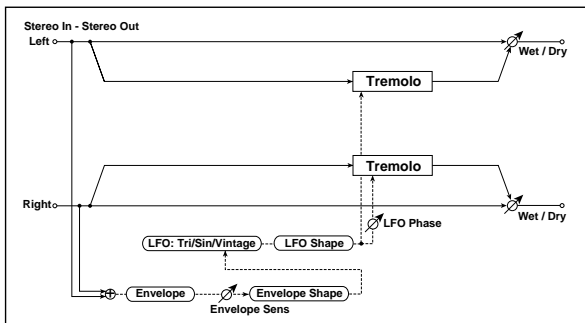

**ENVELOPE**

**Sensitivity** [0...100]

Sets the envelope’s sensitivity to the input signal.

**Shape** [+/-100]

Sets the envelope’s curvature.

**TREMOLO**

**Depth** [0...100]

Sets the initial amount of tremolo.

**Envelope Amount** [+/-100]

Sets the amount added to or subtracted from the **Depth** when the envelope is at maximum.

**Modulation Example**

The graphic below shows an example of tremolo modulation with negative modulation of both **Depth** and **Frequency**. At the start of the note, the input is at maximum volume. This slows down the LFO **Frequency** to 1.0Hz, but also modulates the **Depth** to 0—so the tremolo doesn’t have any effect.

As the input volume dies down, the **Frequency** speeds up; the **Depth** also increases, making the tremolo effect increasingly audible. When the input volume approaches silence, the **Depth** is at its maximum (100) and **Frequency** is at 8Hz.

**LFO**

**Waveform** [Triangle, Sine, Vintage]

Selects the LFO Waveform.

**Shape** [+/-100]

Changes the curvature of the LFO Waveform. p.910.

**Phase [degrees]** [-180...+180]

Sets the LFO phase difference between the left and right. p.945.

**Frequency [Hz]** [0.02...20.00]

Sets initial speed of the LFO. p.946.

**Envelope Amount [Hz]** [-20.00...+20.00]

Sets the amount added to or subtracted from the **Frequency** when the envelope is at maximum. p.946.

**OUTPUT**

This is the standard effects output section, with modulatable control over wet/dry balance. For more information, see “OUTPUT” on page 890.

## 063: Stereo Auto Pan

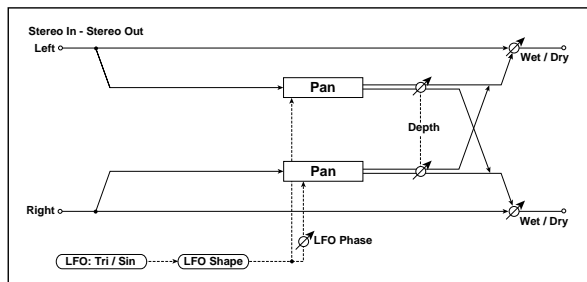

This is a stereo-in, stereo-out auto-panner. The Phase and Shape parameters lets you create various panning effects, such as making the left and right inputs seem to chase each other around the stereo field.

### AUTO PAN

**Depth** D<sup>mod</sup> [0...100]

Sets the depth of LFO modulation.

**Source** [Off...Tempo]

Selects the modulation source of the depth of modulation.

**Amount** [+/-100]

Sets the modulation amount of the depth of modulation.

### LFO

**Waveform** [Triangle, Sine]

Selects the LFO Waveform.

**Shape** [+/-100]

This changes the curvature of the LFO Waveform, which controls the way that the audio moves around the stereo field.

**Phase [degrees]** [-180...+180]

This determines the phase difference between the left and right LFOs. When you gradually change the value away from 0, the sounds from the left and right channels will seem to chase each other around. If you set the parameter to +180 or -180, the sounds from each channel will cross over each other.

You'll only hear the effect of this parameter if the input is true stereo, with different signals in the left and right channels.

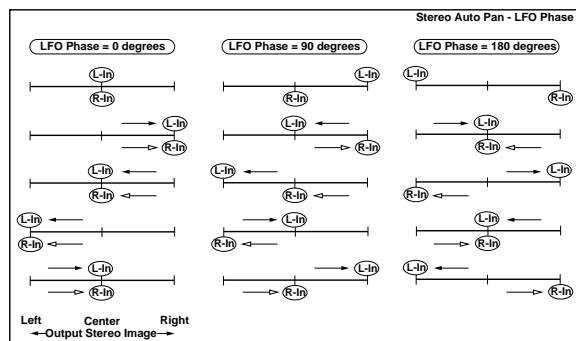

**Frequency [Hz]** D<sup>mod</sup> [0.02...20.00]

This sets the LFO speed, in Hz. It applies only when MIDI/Tempo Sync, below, is Off.

**Source** [Off...Tempo]

This selects a modulation source for the Frequency.

**Amount** [-20.00...+20.00]

This sets the Frequency modulation amount, in Hz.

**MIDI/Tempo Sync** D<sup>mod</sup> [Check-box]

**BPM** [MIDI, 40.00...300.00]

**Base Note** [♩...♩]

**Times** [x1...x32]

When MIDI/Tempo Sync is on, the LFO speed is set by BPM, Base Note, and Times, instead of Frequency. For more information, see "MIDI/Tempo Sync" on page 907.

**Type** [Individual, Common1, Common2]

This controls whether the effect uses its individual LFO, or one of the Common FX LFOs. For more information, see "LFO Type" on page 907.

**Common LFO Phase Offset [degrees]** [+/-180]

When Type is set to Common FX LFO 1 or 2, this lets you offset the phase from the master LFO.

### OUTPUT

This is the standard effects output section, with modulatable control over wet/dry balance. For more information, see "OUTPUT" on page 890.

## 064: Stereo Phaser+Tremolo

This effect combines a stereo phaser and tremolo, with linked LFOs. Swelling phaser modulation and tremolo effects synchronize with each other, creating a soothing modulation effect particularly suitable for electric piano.

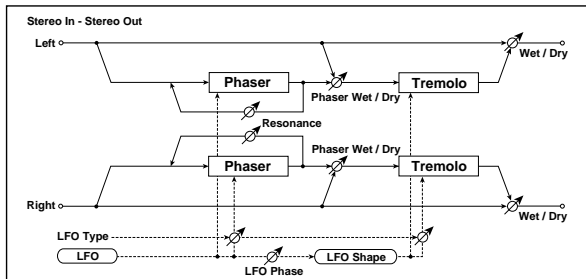

### PHASER

**Manual** [0...100]

Sets the phaser frequency range.

**Depth**  $D_{mod}$  [0...100]

Sets the phaser modulation depth.

**Source** [Off...Tempo]

Selects the modulation source for the phaser modulation depth.

**Amount** [+/-100]

Sets the modulation amount for the phaser modulation depth.

**Resonance** [+/-100]

Sets the phaser resonance amount.

**Wet/Dry** [-Wet, -2:98...Dry...2:98, Wet]

Sets the balance between the phaser effect and the dry sound, feeding into the tremolo. Values are in steps of two (2:98, 4:96 etc). Note that the OUTPUT section's **Wet/Dry** parameter controls the overall wet/dry balance.

### TREMOLO

**Shape** [+/-100]

Sets the degree of the tremolo LFO shaping. p.910.

**Depth**  $D_{mod}$  [0...100]

Sets the tremolo modulation depth.

**Source** [Off...Tempo]

Selects the modulation source for the tremolo modulation depth.

**Amount** [+/-100]

Sets the modulation amount of the tremolo modulation depth.

### LFO

**L/R Phase Type**

[Phaser - Tremolo,  
Phaser - Tremolo Spin,  
Phaser LR - Tremolo,  
Phaser LR - Tremolo Spin,  
Phaser LR - Tremolo LR]

The phaser and the tremolo are both stereo, and each has its own stereo LFO. This parameter controls the stereo phase relationships of the LFOs within the individual effects.

There are two options for the Phaser, and three options for the Tremolo, as described below. The menu selections set both simultaneously.

**Phaser:** the phaser's left and right LFOs are in phase with one another.

**Phaser LR:** the phaser's left and right LFOs are 180 degrees out of phase, enhancing the stereo effect.

**Tremolo:** the tremolo's left and right LFOs are in phase with one another, causing simple amplitude modulation without stereo panning.

**Tremolo Spin:** the tremolo's left and right LFOs are offset, causing the sound to appear to spin around the listener.

**Tremolo LR:** the tremolo's left and right LFOs are 180 degrees out of phase, causing the signal to pan between the left and right channels.

**Phaser/Tremolo Phase [degrees]** [-180, -90, 0, +90, +180]

This lets you offset the phase between the phaser's LFOs and the tremolo's LFOs. The result is that the peaks of the phaser and the amplitude modulation or panning of the tremolo will overlap in different ways, altering the sensations of movement and rotation in the sound.

**Frequency [Hz]**  $D_{mod}$  [0.02...20.00]

This sets the LFO speed, in Hz. It applies only when **MIDI/Tempo Sync**, below, is **Off**.

**Source** [Off...Tempo]

This selects a modulation source for the **Frequency**.

**Amount** [-20.00...+20.00]

This sets the **Frequency** modulation amount, in Hz.

**MIDI/Tempo Sync**  $D_{mod}$  [Check-box]

**BPM** [MIDI, 40.00...300.00]

**Base Note** [♭ ... ♯]

**Times** [x1...x32]

When **MIDI/Tempo Sync** is on, the LFO speed is set by **BPM**, **Base Note**, and **Times**, instead of **Frequency**. For more information, see "MIDI/Tempo Sync" on page 907.

**Type** [Individual, Common1, Common2]

This controls whether the effect uses its individual LFO, or one of the Common FX LFOs. For more information, see “LFO Type” on page 907.

**Common LFO Phase Offset [degrees]** [+/-180]

When Type is set to **Common FX LFO 1** or **2**, this lets you offset the phase from the master LFO.

## 065: Stereo Ring Modulator

This effect creates a metallic sound by applying the oscillators to the input signal. Use the LFO or Dynamic Modulation to modulate the oscillator to create a radical modulation. Matching the oscillator frequency with a note number will produce a ring modulation effect in specific key ranges.

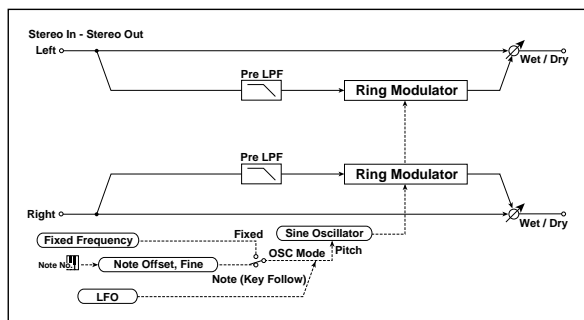

### RING MODULATOR

**Pre LPF** [0...100]

If the input is very bright, the ring modulator may sound harsh or noisy. If this occurs, you can smooth out the effect by increasing the **Pre LPF** (Low Pass Filter) setting, to cut out some of the input’s high frequencies. The higher the setting, the more the high frequencies will be cut.

**OSC Mode** [Fixed, Note (Key Follow)]

This determines whether the oscillator frequency follows the note number, or stays at a fixed value.

**Note (Key Follow):** The oscillator’s frequency is based on MIDI note number (on the effect’s MIDI channel), allowing you to use it as an octaver. The **Note Interval** parameter, below, sets the pitch offset from the original note, in semitones. Matching the oscillator frequency with the note number produces a more gentle ring modulation effect, in the correct key.

**Fixed:** the oscillator uses the manually-set **Fixed Frequency**, below.

**Fixed Frequency [Hz]** [0...12.00k]

This controls the oscillator frequency when **OSC Mode** is set to **Fixed**.

**Source** [Off...Tempo]

Selects the modulation source for the oscillator frequency when **OSC Mode** is set to **Fixed**.

**Amount** [-12.00k...+12.00k]

Sets the oscillator frequency modulation amount when **OSC Mode** is set to **Fixed**.

### OUTPUT

This is the standard effects output section, with modulatable control over wet/dry balance. For more information, see “OUTPUT” on page 890.

**Note Offset** [-48...+48]

This sets a pitch offset from the received MIDI note number, in semitones. It applies only when **OSC Mode** is set to **Note (Key Follow)**.

Try using offsets of octaves (+/-12, 24, etc.) or fifths (+7, +19, -5, etc.).

**Note Fine** [+/-100]

This adjusts the frequency in cents (1/100 of a semitone). It applies only when **OSC Mode** is set to **Note (Key Follow)**.

**LFO Depth** [0...100]

Sets the depth of LFO modulation for the oscillator frequency.

**Source** [Off...Tempo]

Selects the modulation source of the depth of modulation.

**Amount** [+/-100]

Sets the modulation amount of the depth of modulation.

### LFO

**Frequency [Hz]** [0.02...20.00]

This sets the LFO speed, in Hz. It applies only when **MIDI/Tempo Sync**, below, is **Off**.

**Source** [Off...Tempo]

This selects a modulation source for the **Frequency**.

**Amount** [-20.00...+20.00]

This sets the **Frequency** modulation amount, in Hz.

**MIDI/Tempo Sync** [Check-box]

**BPM** [MIDI, 40.00...300.00]

**Base Note** [Musical Note]

**Times** [x1...x32]

When **MIDI/Tempo Sync** is on, the LFO speed is set by **BPM**, **Base Note**, and **Times**, instead of **Frequency**. For more information, see “MIDI/Tempo Sync” on page 907.

**Type** [Individual, Common1, Common2]

This controls whether the effect uses its individual LFO, or one of the Common FX LFOs. For more information, see “LFO Type” on page 907.



**Common LFO Phase Offset [degrees] [+/-180]**

When Type is set to **Common FX LFO 1** or **2**, this lets you offset the phase from the master LFO.

**066: Stereo Frequency Shifter**

This is a stereo effect that shifts the frequency of the input signal. You can use LFO modulation and delay to produce a wide range of pitch-change effects.

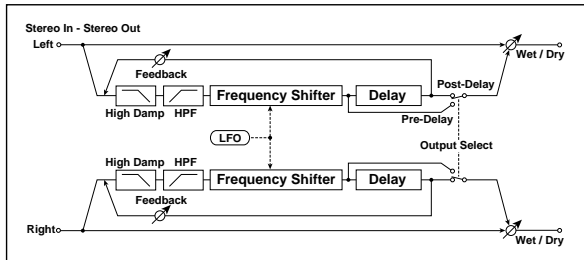

**FREQUENCY SHIFTER**

**High Damp [%] [0...99]**

Sets the high-frequency attenuation of the delayed sound.

**HPF Fc [Hz] [20...11.90k]**

Sets the cutoff frequency for the high pass filter.

**Frequency Shift [Hz] <sup>D<sub>mod</sub></sup> [-6.00k...+6.00k]**

Sets the amount of frequency shift.

**Source [Off...Tempo]**

Selects the modulation source that will control frequency shift.

**Amount [-6.00k...+6.00k]**

Sets the modulation amount for controlling frequency shift.

**LFO Depth [Hz] <sup>D<sub>mod</sub></sup> [-6.00k...+6.00k]**

Sets the depth by which the LFO will modulate the frequency shift.

**Source [Off...Tempo]**

Selects the modulation source that will control LFO modulation of frequency shift.

**Amount [-6.00k...+6.00k]**

Sets the amount by which the modulation source will control LFO modulation of the frequency shift.

**LFO**

**Frequency [Hz] <sup>D<sub>mod</sub></sup> [0.02...20.00]**

This sets the LFO speed, in Hz. It applies only when **MIDI/Tempo Sync**, below, is **Off**.

**Source [Off...Tempo]**

This selects a modulation source for the **Frequency**.

**OUTPUT**

This is the standard effects output section, with modulatable control over wet/dry balance. For more information, see "OUTPUT" on page 890.

**Amount [-20.00...+20.00]**

This sets the **Frequency** modulation amount, in Hz.

**MIDI/Tempo Sync <sup>D<sub>mod</sub></sup> [Check-box]**

**BPM [MIDI, 40.00...300.00]**

**Base Note [♩...♩]**

**Times [x1...x32]**

When **MIDI/Tempo Sync** is on, the LFO speed is set by **BPM**, **Base Note**, and **Times**, instead of **Frequency**. For more information, see "MIDI/Tempo Sync" on page 907.

**Type [Individual, Common1, Common2]**

This controls whether the effect uses its individual LFO, or one of the Common FX LFOs. For more information, see "LFO Type" on page 907.

**Common LFO Phase Offset [degrees] [+/-180]**

When Type is set to **Common FX LFO 1** or **2**, this lets you offset the phase from the master LFO.

**DELAY**

**Delay Time [msec] [0.0...2730.0]**

Sets the delay time.

**Feedback <sup>D<sub>mod</sub></sup> [+/-100]**

Sets the feedback amount.

**Source [Off...Tempo]**

Selects the modulation source of feedback amount.

**Amount [+/-100]**

Sets the depth by which feedback amount will be modulated.

**Output Select [pre-delay, post-delay]**

Selects whether the pre-delay or the post-delay sound will be output.

**OUTPUT**

This is the standard effects output section, with modulatable control over wet/dry balance. For more information, see "OUTPUT" on page 890.

## 067: Detune

This effect offsets the pitch slightly from the input signal. Compared to a chorus, this can be used to create a more subtle thickening effect,

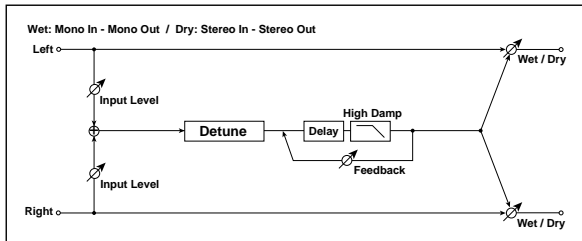

### INPUT

**Input Level Dmod [%]**  $D_{mod}$  [+/-100]

Sets the modulation amount for the input level.

**Source** [Off...Tempo]

Selects the modulation source for the input level.

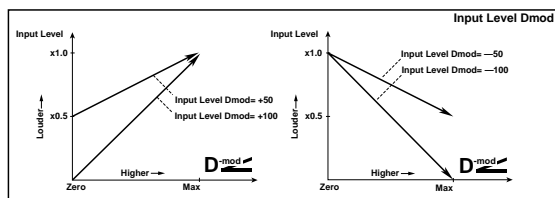

### PITCH SHIFTER

**Pitch Shift [cents]**  $D_{mod}$  [+/-100]

Sets the pitch difference from the input signal.

**Source** [Off...Tempo]

Selects a modulation source for pitch shift.

**Amount** [+/-100]

Sets the modulation amount for pitch shift.

### DELAY

**Delay Time [msec]** [0...1000]

Sets the delay time.

**Feedback** [+/-100]

Sets the feedback amount.

**High Damp [%]** [0...100]

Sets the amount of high-frequency attenuation for the feedback path.

### OUTPUT

This is the standard effects output section, with modulatable control over wet/dry balance. For more information, see "OUTPUT" on page 890.

## 068: Pitch Shifter

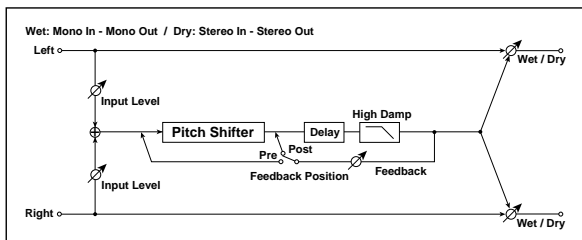

This effect changes the pitch of the input signal. The built-in 2-second delay can be fed back through the pitch shifter, for classic, spiraling effects.

### INPUT

**Input Level Dmod [%]**  $D_{mod}$  [+/-100]

Sets the modulation amount of the input level. See "Input Level Dmod [%]" on page 951.

**Source** [Off...Tempo]

Selects the modulation source for the input level.

### PITCH SHIFTER

**Mode** [Slow, Medium, Fast]

This controls the basic operation of the pitch shifter.

**Slow** preserves the tonal quality of the input, but adds a fixed amount of delay. This generally works best with moderate **Pitch Shift** settings.

**Fast** provides a quick response time, but may change the tone. This generally works best with extreme **Pitch Shift** settings.

**Medium** is in-between these two.

**Pitch Shift [1/2 steps]**  $D_{mod}$  [-24...+24]

This sets the basic amount of pitch shifting, in semitones. You can also make precise adjustments using **Fine [cents]**, below.

**Fine [cents]**  $D_{mod}$  [+/-100]

This adjusts the pitch shift in cents (1/100 of a semitone).

**Source** [Off...Tempo]

This selects the modulation source for **Pitch Shift**. As with **Pitch Shift** itself, you can set the amount of modulation in both semitones and cents.

**Pitch Shift Amount** [-24...+24]

This sets the basic amount of modulation, in semitones. You can also make precise adjustments using **Fine Amount**, below.

**Fine Amount** [+/-100]

This adjusts the amount of modulation in cents (1/100 of a semitone).

**DELAY**

**Delay Time [msec]** [0...2000]

Sets the delay time.

**Feedback Position** [Pre, Post]

**Pre** feeds the delay back through the pitch shifter. Each time the feedback repeats, the pitch will get increasingly lower or higher.

**Post** means that the feedback does not go through the pitch shifter, so that the pitch stays the same through successive repeats.

**Feedback** [+/-100]

Sets the feedback amount.

**High Damp [%]** [0...100]

Sets the amount of high-frequency attenuation for the feedback path.

**OUTPUT**

This is the standard effects output section, with modulatable control over wet/dry balance. For more information, see "OUTPUT" on page 890.

**069: Stereo Pitch Shifter**

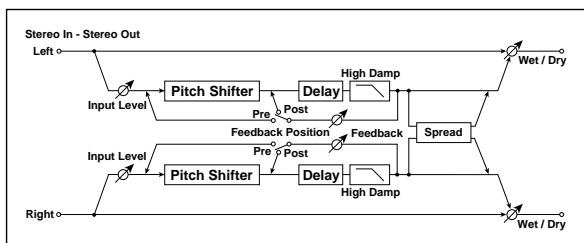

This is a stereo pitch shifter. The pitch shift amount for the left and right channels can be reversed from each other.

**INPUT**

**Input Level Dmod [%]** [+/-100]

Sets the modulation amount of the input level. See "Input Level Dmod [%]" on page 951.

**Source** [Off...Tempo]

Selects the modulation source for the input level.

**PITCH SHIFTER**

**Mode** [Slow, Medium, Fast]

This controls whether the pitch shift will preserve tonal quality but have a longer delay time (**Slow**), or be fast but with lower quality (**Fast**). For details, see "Mode" on page 951.

**L/R Pitch** [Normal, Up/Down]

Determines whether or not the L/R pitch shift amount is inverted.

**Normal:** The pitches of the left and right channels shift together.

**Up/Down:** the pitch shift amount for the right channel will be reversed. If the pitch shift amount is positive, the pitch of the left channel is raised, and the pitch of the right channel is lowered.

**Pitch Shift [1/2 steps]** [-24...+24]

This sets the basic amount of pitch shifting, in semitones. You can also make precise adjustments using **Fine [cents]**, below.

**Fine [cents]** [+/-100]

This adjusts the pitch shift in cents (1/100 of a semitone).

**Source** [Off...Tempo]

This selects the modulation source for **Pitch Shift**. As with **Pitch Shift** itself, you can set the amount of modulation in both semitones and cents.

**Pitch Shift Amount** [-24...+24]

This sets the basic amount of modulation, in semitones. You can also make precise adjustments using **Fine Amount**, below.

**Fine Amount** [+/-100]

This adjusts the amount of modulation in cents (1/100 of a semitone).

**DELAY**

**L Delay Time [msec]** [0...2000]

Sets the delay time for the left channel.

**R Delay Time [msec]** [0...2000]

Sets the delay time for the right channel.

**Feedback Position** [Pre, Post]

**Pre** feeds the delay back through the pitch shifter. Each time the feedback repeats, the pitch will get increasingly lower or higher.

**Post** means that the feedback does not go through the pitch shifter, so that the pitch stays the same through successive repeats.

**Feedback** [+/-100]

Sets the feedback amount.

**High Damp [%]** [0...100]

Sets the amount of high-frequency attenuation for the feedback path.

**Spread** [+/-100]

Sets the width of the stereo image of the effect sound. See "Spread" on page 961.

## OUTPUT

This is the standard effects output section, with modulatable control over wet/dry balance. For more information, see "OUTPUT" on page 890.

## 070: Pitch Shifter BPM

This pitch shifter enables you to set the delay time to match the song tempo.

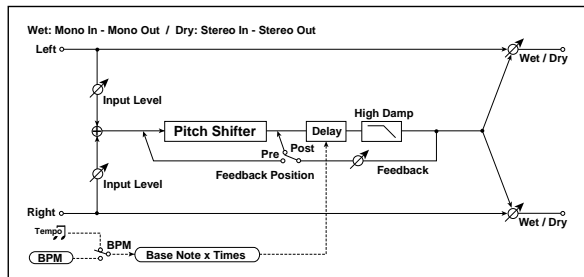

## INPUT

**Input Level Dmod [%]** D<sub>mod</sub> [+/-100]

Sets the modulation amount of the input level. See "Input Level Dmod [%]" on page 951.

**Source** [Off...Tempo]

Selects the modulation source for the input level.

## PITCH SHIFTER

**Mode** [Slow, Medium, Fast]

This controls whether the pitch shift will preserve tonal quality but have a longer delay time (**Slow**), or be fast but with lower quality (**Fast**). For details, see "Mode" on page 951.

**Pitch Shift [1/2 steps]** D<sub>mod</sub> [-24...+24]

Sets the pitch shift amount in steps of a semitone. p.951

**Fine [cents]** D<sub>mod</sub> [+/-100]

Sets the pitch shift amount in steps of one cent. p.951

**Source** [Off...Tempo]

Selects the modulation source for both **Pitch Shift** and **Fine**.

**Pitch Shift Amount** [-24...+24]

Sets the modulation amount for **Pitch Shift**.

**Fine Amount** [+/-100]

Sets the modulation amount for **Fine**.

## DELAY

**BPM** BPM [MIDI, 40.00...300.00]

MIDI syncs to the system tempo; 40-240 sets the tempo manually for this individual effect.

**Time Over?>** [---, OVER!]

The maximum delay time is 2,000msec. If the channel's combination of **BPM**, **Base Note**, and **Times** exceeds this limit, the error message "OVER!" will appear. If this occurs, change the delay time parameters so that this message no longer appears.

**Base Note** BPM [♪...o]

This sets the basic delay length, relative to the **BPM** setting. The values range from a 32nd note to a whole note, including triplets.

**Times** [x1...x32]

This multiplies the length of the **Base Note**. For instance, if the **Base Note** is set to a sixteenth note, and **Times** is set to 3, result will be a dotted eighth note.

**Feedback Position** [Pre, Post]

Switches the feedback connection. p.952.

**Feedback** [+/-100]

Sets the feedback amount. p.952.

**High Damp [%]** [0...100]

Sets the amount of high-frequency attenuation for the feedback path.

## OUTPUT

This is the standard effects output section, with modulatable control over wet/dry balance. For more information, see "OUTPUT" on page 890.

## 071: Stereo Pitch Shifter BPM

This stereo pitch shifter enables you to set the delay time to match the song tempo.

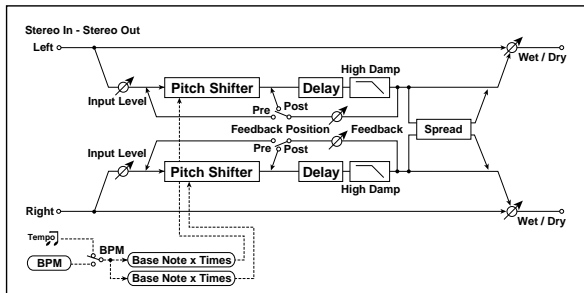

### INPUT

**Input Level Dmod [%]** [+/-100]

Sets the modulation amount of the input level. p.951.

**Source** [Off...Tempo]

Selects the modulation source for the input level. p.951.

### PITCH SHIFTER

**Mode** [Slow, Medium, Fast]

Switches Pitch Shifter mode. p.951.

**L/R Pitch** [Normal, Up/Down]

Determines whether or not the L/R pitch shift amount is inverted. p.952.

**Pitch Shift [1/2 steps]** [-24...+24]

Sets the pitch shift amount in steps of a semitone. p.951

D<sup>mod</sup>

**Fine [cents]** [+/-100]

Sets the pitch shift amount in steps of one cent. p.951

D<sup>mod</sup>

**Source** [Off...Tempo]

Selects the modulation source of pitch shift amount. p.951.

**Pitch Shift Amount** [-24...+24]

Sets the modulation amount of pitch shift amount. p.951.

**Fine Amount** [+/-100]

Sets the modulation amount of pitch shift amount Sets the modulation amount of pitch shift amount. p.951.

### DELAY

**BPM** [MIDI, 40.00...300.00]

MIDI syncs to the system tempo; 40-240 sets the tempo manually for this individual effect. p.953.

**Time Over? L >** [---, OVER!]

Display the error message if the left channel delay time exceeds the upper limit. p.953.

**Time Over? R >** [---, OVER!]

Display the error message if the right channel delay time exceeds the upper limit. p.953.

**L Base Note** [♪...o]

Selects the type of notes to specify the left channel delay time. p.953.

**Times** [x1...x32]

Sets the number of notes to specify the left channel delay time. p.953.

**R Base Note** [♪...o]

Selects the type of notes to specify the right channel delay time. p.953.

**Times** [x1...x32]

Sets the number of notes to specify the right channel delay time. p.953.

**Feedback Position** [Pre, Post]

Switches the feedback connection. p.952.

**Feedback** [+/-100]

Sets the feedback amount. p.952.

**High Damp [%]** [0...100]

Sets the amount of high-frequency attenuation for the feedback path.

**Spread** [+/-100]

Sets the width of the stereo image of the effect sound.

### OUTPUT

This is the standard effects output section, with modulatable control over wet/dry balance. For more information, see "OUTPUT" on page 890.

## 072: Pitch Shift Mod.

This effect uses an LFO to modulate the pitch shift amount, and lets you adjust the panning and stereo width between the effected and dry sounds.

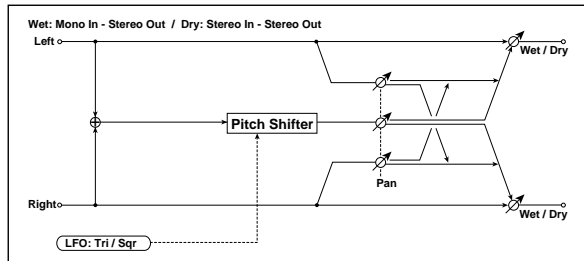

### PITCH SHIFTER

**Pitch Shift [cents]** [+/-100]

Sets the pitch difference from the input signal.

**Depth  $D_{mod}$**  [+/-100]

Sets the LFO modulation depth for pitch shift amount.

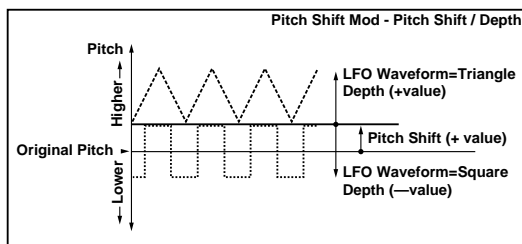

**Source** [Off...Tempo]

Selects the modulation source of the depth of modulation.

**Amount** [+/-100]

Sets the modulation amount of the depth of modulation.

**Pan** [L, 1:99...99:1, R]

This simultaneously controls the panning and stereo width for the pitch-shifted and dry sounds. The value is shown for the pitch-shifted signal, and the dry signal is always at the opposite side of the stereo field.

For instance, when **Pan** is set to L, the effected sound is panned all the way to the left, and the dry sound is panned all the way to the right. When **Pan** is set to R, the panning is reversed.

Intermediate values decrease the stereo width, so that at 50:50, both sounds are centered.

### LFO

**Waveform** [Triangle, Square]

Selects the LFO Waveform.

**Frequency [Hz]  $D_{mod}$**  [0.02...20.00]

Sets the LFO speed, in Hz.

**Source** [Off...Tempo]

Selects a modulation source for LFO speed.

**Amount** [-20.00...+20.00]

Sets the modulation amount of LFO speed.

**MIDI/Tempo Sync  $D_{mod}$**  [Check-box]

**BPM** [MIDI, 40.00...300.00]

**Base Note** [♪...♭]

**Times** [x1...x32]

When **MIDI/Tempo Sync** is on, the LFO speed is set by **BPM**, **Base Note**, and **Times**, instead of **Frequency**. For more information, see "MIDI/Tempo Sync" on page 907.

**LFO Type** [Individual, Common1, Common2]

Selects either (individual) LFO, Common FX LFO1, or Common LFO2. p.907.

**Common LFO Phase Offset [degrees]** [+/-180]

Sets the phase offset when Type = Common 1 or Common 2. p.907.

### OUTPUT

**Wet/Dry  $D_{mod}$**  [Dry, 1:99...99:1, Wet]

Sets the balance between the effect and the dry input. Unlike most effects, when this is set to Wet, the dry and effected signals will be heard at equal volume.

**Source** [Off...Tempo]

Selects a modulation source for Wet/Dry.

**Amount** [+/-100]

Sets the modulation amount for Wet/Dry.

## 073: Organ Vibrato/Chorus

This effect simulates the chorus and vibrato circuitry of a vintage organ. The modulation speed and depth can be customized.

This effect works the same as the Chorus/Vibrato included in the CX-3. For more information, see “7-1c: Vibrato/Chorus” on page 238.

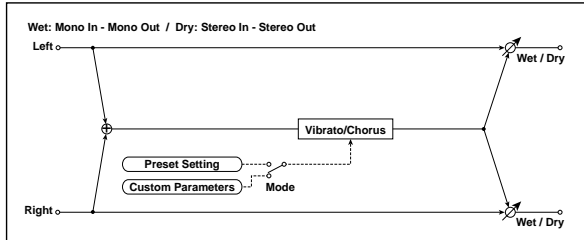

### CONTROL

**Input Trim** [0...100]

Sets the input level.

**Mode** [Preset, Custom]

Selects either preset or custom settings.

### PRESET

**Type** [V1, C1, V2, C2, V3, C3]

Selects the effect type when Mode=Preset.

V1/V2/V3 are variations of vibrato, and C1/C2/C3 are variations of chorus.

**Source** [Off...Tempo]

Selects the modulation source that will change the effect type.

**Amount** [-5...+5]

Sets the modulation amount for changing the effect type.

### CUSTOM

**Mix** [0...100]

Sets the mix level of the direct sound when Mode=Preset.

**Source** [Off...Tempo]

Selects the modulation source that will control the mix level of the direct sound.

**Amount** [+/-100]

Sets the modulation amount for controlling the mix level of the direct sound.

**Depth** [0...100]

Sets the vibrato depth.

**Source** [Off...Tempo]

Selects the modulation source that will control vibrato depth.

**Amount** [+/-100]

Sets the modulation amount for controlling the vibrato depth.

**Speed [Hz]** [0.02...20.00]

Sets the vibrato speed.

**Source** [Off...Tempo]

Selects the modulation source for controlling the vibrato speed.

**Amount** [-20.00...+20.00]

Sets the modulation amount for controlling the vibrato speed.

### OUTPUT

This is the standard effects output section, with modulatable control over wet/dry balance. For more information, see “OUTPUT” on page 890.



## 074: Rotary Speaker

This effect simulates a rotary speaker, and obtains a more realistic sound by simulating the rotor in the low range and the horn in the high range separately. The effect also simulates the stereo microphone settings.

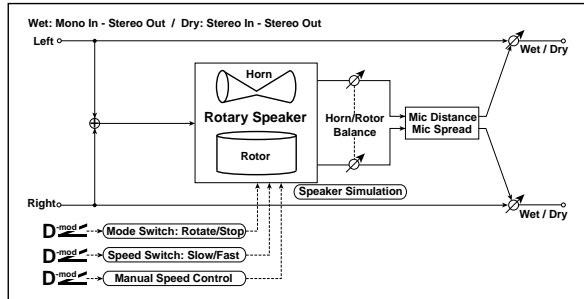

### CONTROL

**Mode Switch**  $D_{mod}$  [Rotate, Stop]

Switches between speaker rotation and stop.

**Source** [Off...Tempo]

Selects a modulation source for Rotate/Stop.

**Mode** [Toggle, Moment]

This parameter controls how the modulation source switches between rotation and stop.

When **Mode** = **Toggle**, the speaker rotates or stops alternately each time you press the pedal or move the joystick. Via MIDI, rotation will switch between start and stop each time the modulation amount exceeds 64.

When **Mode** = **Moment**, the speaker rotates by default, and stops only when you press the pedal or move the joystick. Via MIDI, modulation values above 64 make the speaker rotate, and values below 64 make it stop.

**Speed Switch**  $D_{mod}$  [Slow, Fast]

Switches the speaker rotation speed between slow and fast.

**Source** [Off...Tempo]

Selects a modulation source for Slow/Fast.

**Mode** [Toggle, Moment]

This parameter controls how the modulation source switches the rotation speed between slow and fast.

When **Mode** = **Toggle**, the speed will switch between slow and fast each time you press the pedal or move the joystick. Via MIDI, the speed will switch each time the modulation amount exceeds 64.

When **Mode** = **Moment** (short for Momentary), the speed is usually slow. It becomes fast only when you press the pedal or move the joystick. Via MIDI, modulation values above 64 set the speed to **Fast**, and values below 64 set it to **Slow**.

**Manual Speed**  $D_{mod}$  [Off...Tempo]

This lets you control the rotation speed manually from a selected modulation source, instead of just switching between Slow and Fast. If you don't want to use manual control, set this to **Off**.

### HORN

**Ratio** [Stop, 0.50...2.00]

Adjusts the horn rotation speed, which affects the high frequencies. 1.00 is the default setting. Selecting "Stop" will stop the rotation.

**Acceleration** [0...100]

On a real rotary speaker, the rotation accelerates or decelerates gradually when you switch between slow and fast, or stop and start. This parameter adjusts how quickly the Horn speeds up and slows down.

### ROTOR

**Ratio** [Stop, 0.50...2.00]

Adjusts the rotor speed, which affects the low frequencies. 1.00 is the default setting. Selecting "Stop" will stop the rotation.

**Acceleration** [0...100]

This parameter adjusts how quickly the Rotor speeds up and slows down; see "Acceleration," above.

**Horn/Rotor Balance** [Rotor, 1...99, Horn]

Sets the level balance between the high-frequency horn and low-frequency rotor. See "Acceleration" on page 957.

### MIC

These settings model a pair of stereo microphones, recording the rotary speaker.

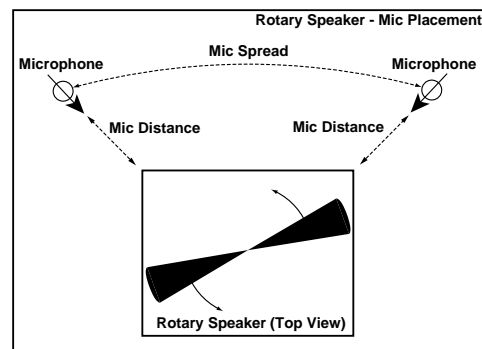

**Distance** [0...100]

This adjusts the distance between the rotary speaker and the microphones. Lower values bring the mics closer to the speaker.

**Spread** [0...100]

Sets the angle between the left and right microphones. Higher settings create a wider stereo effect.

### OUTPUT

This is the standard effects output section, with modulatable control over wet/dry balance. For more information, see "OUTPUT" on page 890.

## 075: Rotary Speaker Pro OD

This is a stereo rotary speaker model, including amp overdrive and speaker simulation.

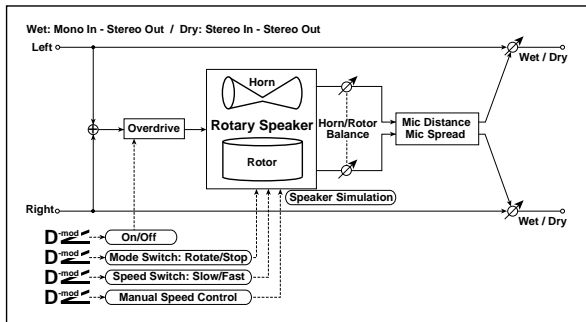

### CONTROL

These parameters set up modulation to start and stop the rotary speaker, and to change its speed. This section is identical to that of the Rotary Speaker effect; for more information, see “CONTROL” on page 957.

### OVERDRIVE

**Switch**  **[Off, On]**

Switches overdrive on/off.

**Source** **[Off...Tempo]**

Selects a modulation source to switch overdrive on/off.

**Mode** **[Toggle, Moment]**

This parameter controls how the modulation source switches the overdrive on and off.

When **Mode = Toggle**, the overdrive turns on or off each time you press the pedal or move the joystick. Via MIDI, overdrive turns on or off each time the modulation amount exceeds 64.

When **Mode = Moment** (short for Momentary), the overdrive is normally off, and turns on only when you press the pedal or move the joystick. Via MIDI, modulation values above 64 turn it on, and values below 64 turn it off.

**Gain** **[0...100]**

Determines the degree of distortion.

**Level** **[0...100]**

Sets the overdrive output level.

**Tone** **[0...15]**

Sets the tonal quality of the overdrive.

### HORN

These parameters control the speed and acceleration of the horn. They are identical to those of the Rotary Speaker effect; for more information, see “HORN” on page 957.

### ROTOR

These parameters control the speed and acceleration of the rotor, the volume balance between the horn and rotor. They are identical to those of the Rotary Speaker effect; for more information, see “ROTOR” on page 957.

### Speaker Simulator

**Speaker Simulator** **[Check-box]**

This part of the effect models the speakers themselves, creating a slightly warmer tone. Use the check-box to turn the speaker simulation on or off.

### MIC

These settings model a pair of stereo microphones recording the rotary speaker. They are identical to those of the Rotary Speaker effect; for more information, see “MIC” on page 957.

### OUTPUT

This is the standard effects output section, with modulatable control over wet/dry balance. For more information, see “OUTPUT” on page 890.

## 076: Rotary Speaker Pro CX

This effect models a vintage rotary speaker, with detailed control over both timbre and behavior. This effect provides the same performance as the Rotary Speaker included in the CX-3. For more information, see “7-2: Rotary Speaker” on page 240.

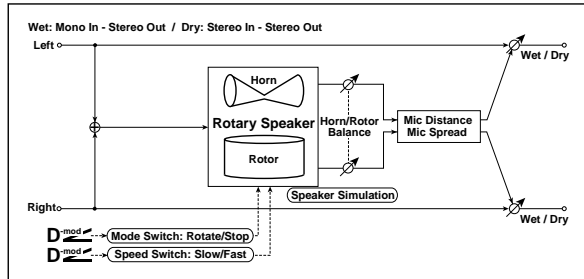

### CONTROL

#### Mode Switch [Rotate, Stop]

This lets you stop the motion of the Rotary Speaker. Even when stopped, the speaker will still affect the timbre.

The horn and rotor can each take different amounts of time to start and stop their rotation. For more information, see the **Start Acceleration** and **Stop Deceleration** parameters under “HORN,” below.

#### Source [Off...Tempo]

This selects a modulation source to start and stop the Rotary Speaker.

#### Mode [Toggle, Moment]

This determines the behavior of the **Mode Switch**. For more information, see “Mode” on page 957.

#### Speed Switch [Slow, Fast]

Switches the speaker rotation speed between slow and fast

#### Source [Off...Tempo]

Selects a modulation source for Slow/Fast.

#### Mode [Toggle, Moment]

This determines the behavior of the **Speed Switch**. For more information, see “Mode” on page 957.

#### Fast Overrides Stop [Check-box]

**On (checked):** setting the **Speed Switch** to **Fast** will make the rotors speed up, even if the **Mode Switch** is set to **Stop**.

**Off (un-checked):** if the **Mode Switch** is set to **Stop**, the rotors will always stay stopped, regardless of the **Speed Switch**.

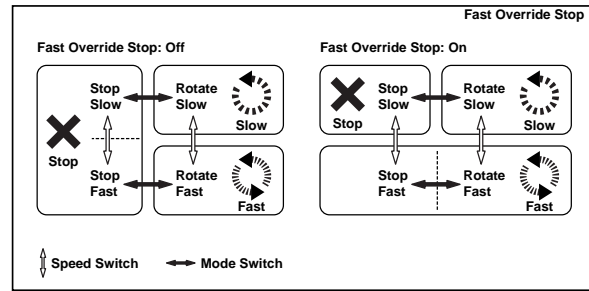

#### Horn Stop Phase [degrees] [Free, -180...+180]

When the **Mode Switch** is set to **Stop**, the Horn gradually comes to rest pointing one way or another. This allows you to control where it will stop.

**Free** lets it come to rest naturally, at a more or less random spot. The other settings,  $-180$  to  $+180$ , let you force it to land in a specific position.

The speaker position has a dramatic effect on the tone, so specifying a fixed position allows you to achieve consistent timbral results.

#### Rotor Stop Phase [degrees] [Free, -180...+180]

This determines where the Rotor will land when the **Mode Switch** is set to **Stop**. For more details, see “Horn Stop Phase [degrees],” above.

### HORN

The horn carries the effect’s high frequencies, while the rotor carries the low frequencies.

#### Fast Speed [0...100]

This specifies the speed of the Horn when the **Speed Switch** is set to **Fast**.

#### Slow Speed [0...100]

This specifies the speed of the Horn when the **Speed Switch** is set to **Slow**.

#### Acceleration [0...100]

This sets how long it takes the Horn to change from the **Slow** speed to the **Fast** speed.

#### Deceleration [0...100]

This sets how long it takes the Horn to change from the **Fast** speed to the **Slow** speed.

#### Start Acceleration [0...100]

This sets how long it takes the Horn to come up to speed after the **Mode Switch** has changed from **Stop** to **Rotate**.

#### Stop Deceleration [0...100]

This sets how long it takes the horn to come to rest after the **Mode Switch** has changed from **Rotate** to **Stop**.

---

**ROTOR**

The rotor carries the low frequencies of the Rotary Speaker. Its parameters are identical to those of the Horn, above.

<b>Fast Speed</b>	<b>[0...100]</b>
<b>Slow Speed</b>	<b>[0...100]</b>
<b>Acceleration</b>	<b>[0...100]</b>
<b>Deceleration</b>	<b>[0...100]</b>
<b>Start Acceleration</b>	<b>[0...100]</b>
<b>Stop Deceleration</b>	<b>[0...100]</b>

***Balance and Tone***

**Horn/Rotor Balance**                    **[Rotor, 1...99, Horn]**

Sets the volume balance between the high-frequency horn and low-frequency rotor.

**Speaker Simulator**                    **[Check-box]**

Switches speaker simulation on/off.

**Match CX-3 Tone**                    **[Off, Amp 1, Amp 2]**

When using this effect on a CX-3 Program, this setting will adjust the tone appropriately for the CX-3's Amp Type. If **AmpType = Type1** or **2**, use the corresponding **Amp1** or **2** setting. If **Amp Type = Pre Amp**, turn this parameter **Off**.

If you're layering two CX-3s together, you may wish to use 133: Rotary Speaker as an IFX (insert effect) for both Programs together, instead of using the Rotary Speakers within the individual Programs. Use this parameter to adjust the tone in such cases.

---

**MIC**

These settings model two pairs of stereo microphones recording the rotary speaker—one pair each for the horn and rotor. In the real world, this would require an elaborate setup, or even splitting the rotary speaker into two—but it's relatively easy in the software world of the KRONOS, and it gives you separate control over the tone and stereo spread of the high and low frequencies.

The other rotary speaker effects have only one pair of mics, but are otherwise similar; for more information, see "MIC" on page 957.

<b>Horn Distance</b>	<b>[0...100]</b>
<b>Horn Spread</b>	<b>[0...100]</b>
<b>Rotor Distance</b>	<b>[0...100]</b>
<b>Rotor Spread</b>	<b>[0...100]</b>

---

**OUTPUT**

This is the standard effects output section, with modulatable control over wet/dry balance. For more information, see "OUTPUT" on page 890.

# Delay

## 077: L/C/R Delay

This multitap delay outputs three Tap signals to the left, right, and center respectively. You can also adjust the stereo width of the delays.

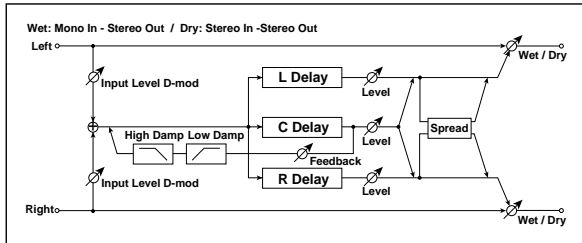

### INPUT

**Input Level Dmod [%]**  $D_{mod}$  [+/-100]

Sets the modulation amount of the input level. p.951.

**Source** [Off...Tempo]

Selects the modulation source for the input level. p.951.

### DELAY

**L Delay Time [msec]** [0...2730]

Sets the delay time of the Left Delay.

**Level** [0...50]

Sets the output level of the Left Delay.

**C Delay Time [msec]** [0...2730]

Sets the delay time of the Center Delay.

**Level** [0...50]

Sets the output level of the Center Delay.

**R Delay Time [msec]** [0...2730]

Sets the delay time of the Right Delay.

**Level** [0...50]

Sets the output level of the Right Delay.

**Feedback (C Delay)**  $D_{mod}$  [+/-100]

Sets the feedback amount of the Center Delay

**Source** [Off...Tempo]

Selects the modulation source of the Center Delay feedback amount.

**Amount** [+/-100]

Sets the modulation amount of the Center Delay feedback amount.

**High Damp [%]** [0...100]

This controls a low-pass filter in the feedback loop, which “damps” (reduces) high frequencies. Higher settings mean more damping, resulting in increasingly darker timbres as the feedback continues.

**Low Damp [%]** [0...100]

This controls a high-pass filter in the feedback loop, which “damps” (reduces) low frequencies. Higher settings mean more damping, resulting in increasingly highpassed, lighter timbres as the feedback continues.

**Spread** [0...50]

This controls the stereo width of the effect. The stereo image is widest with a value of 50, and narrows to mono with a value of 0.

### OUTPUT

This is the standard effects output section, with modulatable control over wet/dry balance. For more information, see “OUTPUT” on page 890.

## 078: L/C/R Long Delay

This multitap delay outputs three Tap signals to left, right and center respectively. You can set a maximum of 5,460msec for the delay time.

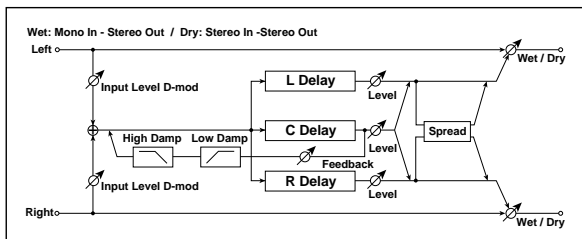

### INPUT

**Input Level Dmod [%]**  $D_{mod}$  [+/-100]

Sets the modulation amount of the input level. p.951.

**Source** [Off...Tempo]

Selects the modulation source for the input level. p.951.

### DELAY

**L Delay Time [msec]** [0...5460]

Sets the delay time of the Left Delay.

**Level** [0...50]

Sets the output level of the Left Delay.

**C Delay Time [msec]** [0...5460]

Sets the delay time of the Center Delay.

**Level** [0...50]

Sets the output level of the Center Delay.

**R Delay Time [msec]** [0...5460]

Sets the delay time of the Right Delay.

**Level** [0...50]

Sets the output level of the Right Delay.

**Feedback (C Delay) D-mod** [+/-100]

Sets the feedback amount of the Center Delay.

**Source** [Off...Tempo]

Selects the modulation source for the Center Delay feedback.

**Amount** [+/-100]

Sets the modulation amount of the Center Delay feedback.

**High Damp [%]** [0...100]

Sets the amount of high-frequency attenuation for the feedback path.

**Low Damp [%]** [0...100]

This controls the low-frequency damping in the feedback loop. See “Low Damp [%]” on page 961.

**Spread** [0...50]

This controls the stereo width of the effect. The stereo image is widest with a value of 50, and narrows to mono with a value of 0.

**OUTPUT**

This is the standard effects output section, with modulatable control over wet/dry balance. For more information, see “OUTPUT” on page 890.

**079: Stereo/Cross Delay**

This is a stereo delay with adjustable feedback routing, high and low damping, modulatable feedback and input level, and up to 1,360msec of delay time.

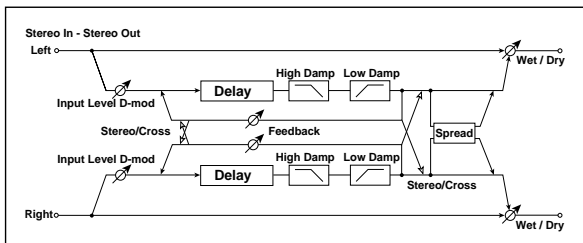

**INPUT**

**Input Level Dmod [%] D-mod** [+/-100]

Sets the modulation amount of the input level. p.951.

**Source** [Off...Tempo]

Selects the modulation source for the input level. p.951.

**DELAY**

**Stereo/Cross** [Stereo, Cross]

Switches between stereo delay and cross-feedback delay.

**L Delay Time [msec]** [0.0...1360.0]

Sets the delay time for the left channel.

**R Delay Time [msec]** [0.0...1360.0]

Sets the delay time for the right channel.

**L Feedback D-mod** [+/-100]

Sets the feedback amount for the left channel.

**R Feedback D-mod** [+/-100]

Sets the feedback amount for the right channel.

**Source** [Off...Tempo]

Selects the modulation source of feedback amount.

**L Amount** [+/-100]

Sets the modulation amount of the left channel feedback.

**R Amount** [+/-100]

Sets the modulation amount of the right channel feedback.

**High Damp [%]** [0...100]

Sets the amount of high-frequency attenuation for the feedback path.

**Low Damp [%]** [0...100]

This controls the low-frequency damping in the feedback loop. See “Low Damp [%]” on page 961.

**Spread** [-50...+50]

This controls the stereo width of the effect. The stereo image is widest with a value of 50, and narrows to mono with a value of 0.

**OUTPUT**

This is the standard effects output section, with modulatable control over wet/dry balance. For more information, see “OUTPUT” on page 890.

## 080: Stereo/Cross Long Delay

This is a stereo delay with adjustable feedback routing, high and low damping, modulatable feedback and input level, and up to 2,730msec of delay time.

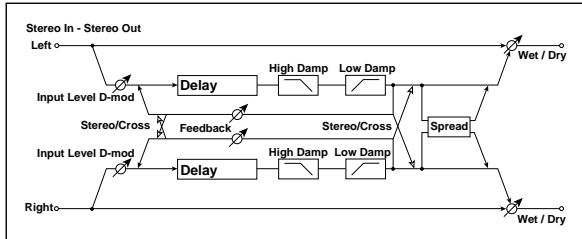

### INPUT

**Input Level Dmod [%]**  $D_{mod}$  [+/-100]

Sets the modulation amount for the input level. For more information, see "Input Level Dmod [%]" on page 951.

**Source** [Off...Tempo]

Selects the modulation source for the input level. For more information, see "Source" on page 951.

### DELAY

**Stereo/Cross** [Stereo, Cross]

This changes the feedback routing.

**Stereo** means that the left and right channels feed back into themselves, preserving the stereo image.

**Cross** makes the left channel feeds back into the right, and vice-versa.

**L Delay Time [msec]** [0.0...] 2730.0

Sets the delay time for the left channel.

**R Delay Time [msec]** [0.0...] 2730.0

Sets the delay time for the right channel.

**L Feedback  $D_{mod}$**  [+/-100]

Sets the feedback amount for the left channel.

**R Feedback  $D_{mod}$**  [+/-100]

Sets the feedback amount for the right channel.

**Source** [Off...Tempo]

Selects the modulation source of feedback amount.

**L Amount** [+/-100]

Sets the modulation amount of the left channel feedback.

**R Amount** [+/-100]

Sets the modulation amount of the right channel feedback.

**High Damp [%]** [0...100]

Sets the amount of high-frequency attenuation for the feedback path.

**Low Damp [%]** [0...100]

This controls the low-frequency damping in the feedback loop. See "Low Damp [%]" on page 961.

**Spread** [-50...+50]

This controls the stereo width of the effect. The stereo image is widest with a value of 50, and narrows to mono with a value of 0.

### OUTPUT

This is the standard effects output section, with modulatable control over wet/dry balance. For more information, see "OUTPUT" on page 890.

## 081: Stereo Multitap Delay

The left and right Multitap Delays have two taps respectively. Changing the routing of feedback and tap output allows you to create various patterns of complex effect sounds.

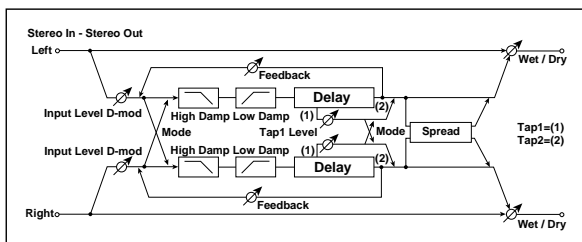

### INPUT

**Input Level Dmod [%]**  $D_{mod}$  [+/-100]

Sets the modulation amount of the input level. See "Input Level Dmod [%]" on page 951.

**Source** [Off...Tempo]

Selects the modulation source for the input level. p.951.

### DELAY

**Mode** [Normal, Cross Feedback, Cross Pan1, Cross Pan2]

This lets you alter the stereo image by switching the inputs and feedback paths of the left and right delays, as shown in the figure below. In order for this to be effective, the input needs to be a true stereo signal.



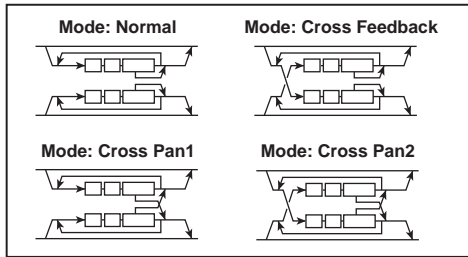

**Tap1 Time [msec]** [0.0...1360.0]

Sets the Tap1 delay time.

**Tap2 Time [msec]** [0.0...1360.0]

Sets the Tap2 delay time.

**Feedback (Tap2) D<sub>mod</sub>** [+/-100]

Sets the Tap2 feedback amount.

**Source** [Off...Tempo]

Selects the modulation source of the Tap2 feedback amount.

**Amount** [+/-100]

Sets the modulation amount of the Tap2 feedback amount.

**Tap1 Level** [0...100]

This lets you adjust the relative volume of Tap1, compared to Tap2 (which is always at the maximum volume). Setting a lower volume for Tap1 can help to create interesting accent patterns.

**High Damp [%]** [0...100]

This controls the high-frequency attenuation in the feedback loop.

**Low Damp [%]** [0...100]

This controls the low-frequency damping in the feedback loop. See “Low Damp [%]” on page 961.

**Spread D<sub>mod</sub>** [+/-100]

This controls the stereo width of the effect. The stereo image is widest with a value of 50, and narrows to mono with a value of 0.

**Source** [Off...Tempo]

Selects the modulation source for Spread.

**Amount** [+/-100]

Sets the modulation amount for Spread.

**OUTPUT**

This is the standard effects output section, with modulatable control over wet/dry balance. For more information, see “OUTPUT” on page 890.

**082: Stereo Modulation Delay**

This stereo delay uses either an LFO or a Dmod source to modulate the delay time. This causes the delay’s pitch to vary, creating an effect which swells and shimmers like a cross between an echo and a chorus.

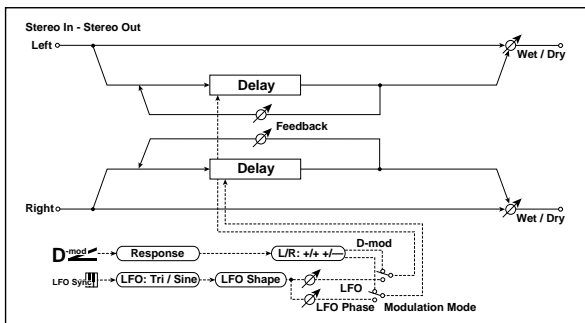

**CONTROL**

**Modulation Mode** [LFO, Dmod]

This selects whether the delay time will be swept by the LFO or by the selected Dmod source.

**Dmod Modulation D<sub>mod</sub>** [L/R: +/+, L/R: +/-]

This applies only if Modulation Mode is set to Dmod.

L/R: +/+ : the Dmod source modulates both left and right delays equally.

L/R: +/- : the Dmod source modulates left and right inversely, for a deeper stereo effect.

**Source** [Off...Tempo]

Selects a modulation source to control the delay time. This applies only if Modulation Mode is set to Dmod.

**Response** [0...30]

This controls how quickly the delay times change in response to the modulation source. Higher values mean faster response times.

**LFO**

All of the LFO controls apply only when the Modulation Mode is set to LFO.

**Waveform** [Triangle, Sine]

Selects the LFO Waveform.

**Shape** [-100...+100]

Changes the curvature of the LFO Waveform. For more information, see “Shape” on page 910.

**L LFO Phase [degrees]** [-180...+180]

This sets the initial phase of the left LFO. The relationship between this and the R LFO Phase controls the depth of the stereo effect and the richness of the pitch changes. As a start, try setting one to +90 and the other to -90.

**R LFO Phase [degrees]** [-180...+180]

This sets the initial phase of the right LFO.

**Dmod Sync**  [Check-box]

This enables reset of the LFOs from a Dmod source, as selected below.

**Source** [Off...Tempo]

If **Dmod Sync** is **On**, this selects the modulation source to reset the LFOs, using the initial phases set by **L LFO Phase** and **R LFO Phase** above.

For example, if you set the **Source** to Gate 2, playing on the keyboard will reset the LFOs so that the modulation sounds the same at the start of each phrase.

**MIDI** The LFOs are reset when the modulation value changes from 63 or smaller to 64 or higher.

**Frequency [Hz]**  [0.02...20.00]

This sets the LFO speed, in Hz.

**MIDI/Tempo Sync**  [Check-box]

**BPM** [MIDI, 40.00...300.00]

**Base Note**  [...]

**Times** [x1...x32]

When **MIDI/Tempo Sync** is on, the LFO speed is set by **BPM**, **Base Note**, and **Times**, instead of **Frequency**. For more information, see “MIDI/Tempo Sync” on page 907.

**Type** [Individual, Common1, Common2]

This controls whether the effect uses its individual LFO, or one of the Common FX LFOs. For more information, see “LFO Type” on page 907.

**Common LFO Phase Offset [degrees]** [ +/-180]

When **Type** is set to **Common FX LFO 1** or **2**, this lets you offset the phase from the master LFO.

### MOD DELAY

**L Delay Time [msec]** [0.0...1000.0]

Sets the delay time for the left channel.

**R Delay Time [msec]** [0.0...1000.0]

Sets the delay time for the right channel.

**L Depth** [0...200]

Sets the amount of pitch modulation for the left channel. 0...100 produce chorus-like effects; over 100 produces more obvious pitch-shifting.

**R Depth** [0...200]

Sets the amount of pitch modulation for the right channel.

**L Feedback** [ +/-100]

Sets the amount of feedback for the left delay. Negative values invert the phase.

**R Feedback** [ +/-100]

Sets the amount of feedback for the right delay.

### OUTPUT

This is the standard effects output section, with modulatable control over wet/dry balance. For more information, see “OUTPUT” on page 890.

## 083: Stereo Dynamic Delay

This stereo delay uses the input signal level to control either the wet/dry mix or the feedback level. You can use this to create:

- Ducked delays, in which the delays get softer when the input is loud (the delays “duck” to get out of the way).
- Gated delays, in which the delays are louder when the input is loud. For instance, you can create a thick, layered lead sound using delays, and then make the level or feedback of the delays reduce automatically when you stop playing.

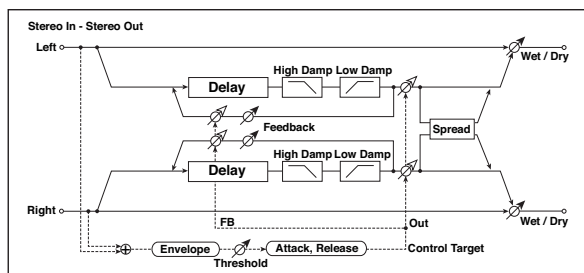

### CONTROL

**Target** [None, Output Level, Feedback]

This selects the modulation target for the input signal.

**Output Level** modulates the **Wet/Dry** mix.

**Feedback** modulates the **Feedback** amount.

**Polarity** [+,-]

+ (**positive**): The modulation applies only when the input signal is *below* the **Threshold**. Use this to lower the effect level when the input signal is quiet.

- (**negative**): The modulation applies only when the input signal is *above* the **Threshold**. Use this to lower the effect level when the input signal is loud (for “ducking”).

**Offset** [0...100]

This controls the amount of modulation for the Target parameter (either **Output Level** or **Feedback**), as a percentage of the parameter’s value.

**Threshold** [0...100]

This sets the input signal level at which the ducking or gating occurs, according to the **Polarity** setting.

**Attack** [1...100]

This controls how fast the gating or ducking starts after the **Threshold** is crossed.

**Release** [1...100]

This controls how fast the gating or ducking stops, after the **Threshold** is crossed in the opposite direction.

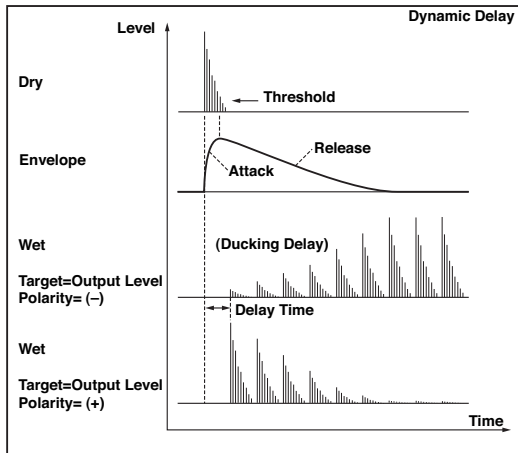

**R Delay Time [msec]** [0.0...1360.0]

Sets the delay time for the right channel.

**Feedback** [+/-100]

Sets the feedback amount.

**High Damp [%]** [0...100]

This controls the high-frequency attenuation in the feedback loop. See "High Damp [%]" on page 961.

**Low Damp [%]** [0...100]

This controls the low-frequency damping in the feedback loop. See "Low Damp [%]" on page 961.

**Spread** [+/-100]

Sets the width of the stereo image of the effect sound. For more information, see "Spread" on page 961.

**OUTPUT**

This is the standard effects output section, with modulatable control over wet/dry balance. For more information, see "OUTPUT" on page 890.

**DELAY**

**L Delay Time [msec]** [0.0...1360.0]

Sets the delay time for the left channel.

**084: Stereo Auto Panning Delay**

This stereo delay effect pans the delay sound left and right using the LFO.

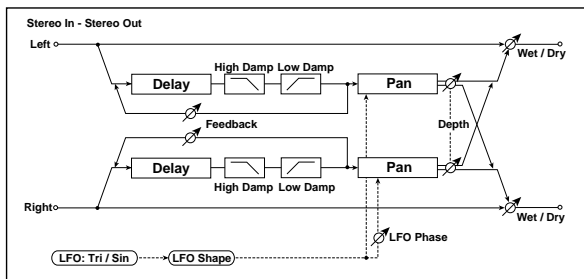

**DELAY**

**L Delay Time [msec]** [0.0...1360.0]

Sets the delay time for the left channel.

**R Delay Time [msec]** [0.0...1360.0]

Sets the delay time for the right channel.

**L Feedback** [+/-100]

Sets the feedback amount for the left channel.

**R Feedback** [+/-100]

Sets the feedback amount for the right channel.

**High Damp [%]** [0...100]

This controls the high-frequency attenuation in the feedback loop. See "High Damp [%]" on page 961.

**Low Damp [%]** [0...100]

This controls the low-frequency damping in the feedback loop. See "Low Damp [%]" on page 961.

**LFO**

**Waveform** [Triangle, Sine]

Selects the LFO Waveform.

**Shape** [+/-100]

Changes the curvature of the LFO Waveform. See "Shape" on page 910.

**Phase [degrees]** [-180...+180]

Sets the LFO phase difference between the left and right. See "Phase [degrees]" on page 945.

**Frequency [Hz]** [0.02...20.00]

This sets the LFO speed, in Hz. It applies only when MIDI/Tempo Sync, below, is Off.

**MIDI/Tempo Sync** [Check-box]

**BPM** [MIDI, 40.00...300.00]

**Base Note** [Musical Notation]

**Times** [x1...x32]

When MIDI/Tempo Sync is on, the LFO speed is set by BPM, Base Note, and Times, instead of Frequency. For more information, see "MIDI/Tempo Sync" on page 907.

**Type** [Individual, Common1, Common2]

This controls whether the effect uses its individual LFO, or one of the Common FX LFOs. For more information, see "LFO Type" on page 907.

**Common LFO Phase Offset [degrees] [+/-180]**

When Type is set to **Common FX LFO 1** or **2**, this lets you offset the phase from the master LFO.

**AUTO PAN**

**Depth  $D_{mod}$  [0...100]**

Sets the panning width.

**Source [Off...Tempo]**

Selects the modulation source for the panning width.

**Amount [+/-100]**

Set the modulation amount of the panning width.

**OUTPUT**

This is the standard effects output section, with modulatable control over wet/dry balance. For more information, see "OUTPUT" on page 890.

**085: Tape Echo**

This effect models a tape echo unit with three playback heads, including the distortion and tonal changes typical of magnetic tape.

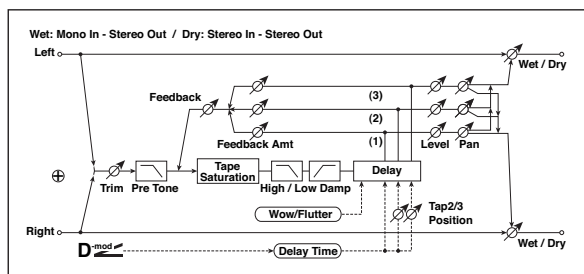

**INPUT**

**Trim [0...100]**

Sets the input gain.

**Pre Tone [0...100]**

This models the reduced high frequencies of an analog tape delay, before the saturation stage. Lower settings create a darker tone.

**WOW & FLUTTER**

This section models the instability of the tape machine's motors. As the speed of the motor fluctuates, the pitch changes slightly. This introduces a pleasant chorus-like effect.

**Frequency [Hz] [0.02...1.00]**

Sets the frequency at which pitch variation occurs.

**Depth [0...100]**

Sets the depth of the pitch change.

**TAPE ECHO**

**Delay Time**

**Delay Time(Tap1) [msec]  $D_{mod}$  [0...2700]**

This parameter sets the delay time of Tap 1.

Also, Taps 2 and 3 are specified as a percentage (%) of this delay time. Taps 2 and 3 always stay in proportion to Tap 1, even when the delay time is modulated.

**Source [Off...Tempo]**

Selects the modulation source for the delay time.

**Amount [-2700...]+2700**

Sets the modulation amount for the delay time.

**Tap2 Position [%] [0...100]**

Sets the delay time of Tap 2, as a percentage of Tap 1's delay time.

**Tap3 Position [%] [0...100]**

Sets the delay time of Tap 3, as a percentage of Tap 1's delay time.

**Level and Pan 1...3**

Each tap has its own controls for level and pan.

**Tap1...3 Level [0...100]**

Sets the tap's output level.

**Pan [L, 1...99, R]**

Sets the tap's stereo position.

**Feedback**

**Tap1...3 Feedback Amount [+/-100]**

Sets the individual tap's feedback level. Negative values invert the phase. These individual levels are summed together, and then the final level is controlled by **Feedback Level**, below.

**Feedback Level  $D_{mod}$  [0...100]**

Sets the overall level of feedback.

**Source [Off...Tempo]**

Selects the modulation source for the **Feedback Level**.

**Amount [+/-100]**

Sets the modulation amount for the **Feedback Level**.

**Tone**

**High Damp [%] [0...100]**

This cuts the high frequencies in both the main output and the feedback. Higher settings create a darker tone.

**Low Damp [%] [0...100]**

This cuts the low frequencies in both the main output and the feedback. Higher settings mean less low-end.

**Saturation [0...100]**

This models the distortion of an analog tape delay.

## OUTPUT

This is the standard effects output section, with modulatable control over wet/dry balance. For more information, see "OUTPUT" on page 890.

## 086: Multiband Mod. Delay

This effect divides the input signal into low, mid, and high-frequency bands, and applies a modulation delay to each band.

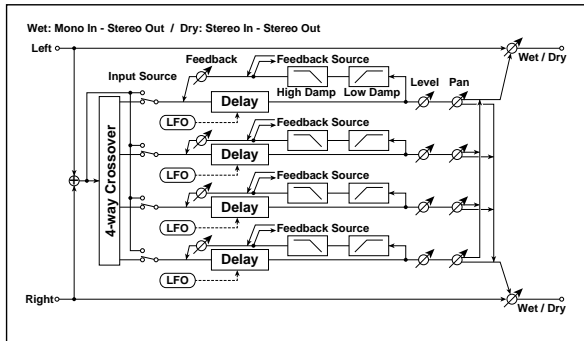

### Dmod

**Input Level [%]  $D_{mod}$**  [ +/-100 ]

Sets the modulation amount of the input level. p.951.

**Src (Source)** [ Off...Tempo ]

Selects the modulation source for the input level. p.951.

**Feedback Src (Source)** [ Off...Tempo ]

Selects the modulation source of feedback amount.

**Output Level Src (Source)** [ Off...Tempo ]

Selects the modulation source for the output level.

### XOVER FILTER

For a description of the on-screen Crossover Filter graphic, see "004: St.Multiband Compressor" on page 894.

**1-2 [Hz]** [ 20...20.00k ]

Sets the frequency at which bands 1 and 2 are divided.

**2-3 [Hz]** [ 20...20.00k ]

Sets the frequency at which bands 2 and 3 are divided.

**3-4 [Hz]** [ 20...20.00k ]

Sets the frequency at which bands 3 and 4 are divided.

### BAND1 DELAY

**Input** [ Xover, Direct ]

Selects the input for band 1: either the signal from the crossover, or the direct signal.

**Feedback Src (Source)** [ Band1, Band2, Band3, Band4 ]

Selects the feedback source for band 1. This lets you connect the feedback of each band to other bands.

**Time [msec]** [ 0.0...1200.0 ]

Sets the delay time for the band 1.

**Pan** [ L, 1...99, R ]

Sets the panning for band 1.

**Feedback  $D_{mod}$**  [ +/-100 ]

Sets the feedback amount for band 1.

**Amt (Feedback Amount)** [ +/-100 ]

Sets the amount of modulation for the band 1 feedback.

**Low Damp [%]** [ 0...100 ]

Sets the amount of low-frequency attenuation for band 1.

**High Damp [%]** [ 0...100 ]

Sets the amount of high-frequency attenuation for band 1.

**Output Level  $D_{mod}$**  [ 0...100 ]

Sets the output level for band 1.

**Amt (Output Level Amount)** [ +/-100 ]

Sets the amount of modulation for band 1's output level.

### BAND2 DELAY

Band 2 has the same parameters as the "BAND1 DELAY," above.

### BAND3 DELAY

Band 3 has the same parameters as the "BAND1 DELAY," above.

### BAND4 DELAY

Band 4 has the same parameters as the "BAND1 DELAY," above.

### BAND1 LFO

**Frequency [Hz]** [ 0.02...20.00 ]

Sets the LFO speed for band 1.

**Depth** [ 0...187 ]

Sets the LFO modulation depth for band 1.

**Type** [ Individ., Cmn1, Cmn2 ]

Selects LFO, Common FX LFO1, or Common LFO2 for band 1. p.907.

**Cmn LFO [deg] (Common LFO Phase Offset [degrees]) [-180...+180]**

Sets the phase offset when Type = Common 1 or Common 2. p.907.

**BAND2 LFO**

Band 2's LFO has the same parameters as the "BAND1 LFO," above.

**BAND3 LFO**

Band 3's LFO has the same parameters as the "BAND1 LFO," above.

**087: Reverse Delay**

This is a delay that plays back the input signal in reverse. You can also continue feedback while alternating playing the signal in reverse and forward directions.

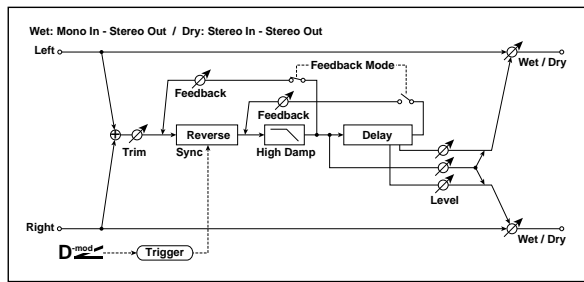

**INPUT**

**Input Level Dmod [%]  $D_{mod}$  [+/-100]**

Sets the modulation amount of the input level.

**Source [Off...Tempo]**

Selects the modulation source for the input level.

**REVERSE DELAY**

**Reverse Time [msec] [0...900]**

Sets the length of the reverse playback (the delay time). For more information, see "Reverse Time and Sync Source," below.

**Level [0...100]**

Sets the output level of the reverse playback.

**L Post-Delay Time [msec] [0...900]**

Sets the delay time of the Left Tap.

**Level [0...100]**

Sets the output level of the Left Tap.

**R Post-Delay Time [msec] [0...900]**

Sets the delay time of the Right Tap.

**Level [0...100]**

Sets the output level of the Right Tap.

**BAND4 LFO**

Band 4's LFO has the same parameters as the "BAND1 LFO," above.

**OUTPUT**

This is the standard effects output section, with modulatable control over wet/dry balance. For more information, see "OUTPUT" on page 890.

**Feedback Mode [Reverse, Reverse/Forward]**

**Reverse:** the feedback plays in reverse.

**Reverse/Forward:** the feedback alternates between playing backwards and forwards, as shown below.

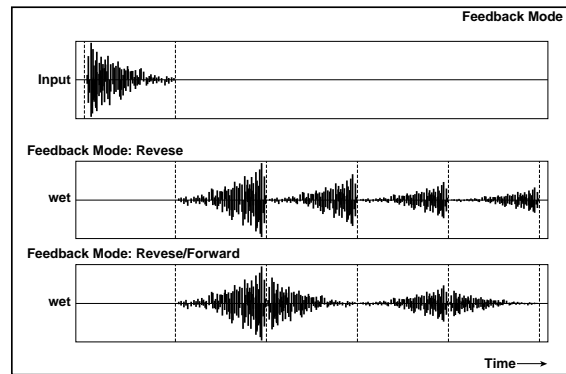

**Feedback  $D_{mod}$  [+/-100]**

Sets the feedback amount.

**Source [Off...Tempo]**

Selects the modulation source of feedback amount.

**Amount [+/-100]**

Sets the feedback amount.

**High Damp [%] [0...100]**

Sets the amount of high-frequency attenuation for the feedback path.

**Sync Source  $D_{mod}$  [Off...Tempo]**

Selects a modulation source to reset the start point of the reverse delay. For more information, see "Reverse Time and Sync Source," below.

**Reverse Time and Sync Source**

The sound will be played in reverse for the duration specified by **Reverse Time**. You can reset the dividing point for reverse playback by specifying a modulation source for **Sync Source**.

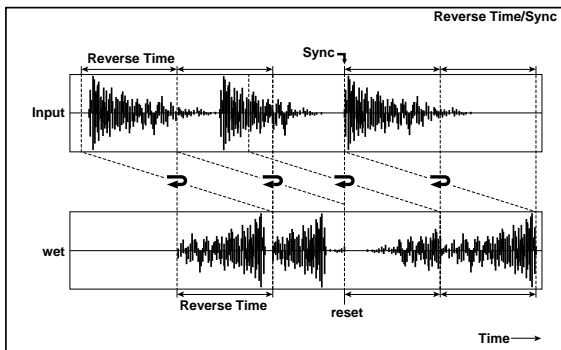

If you set **Sync Source** to Gate1, the delay will be reset at each note-on. This means that you will always hear the reverse playback of the sound that occurs between the note-on and the specified **Reverse Time**.

If you don't specify a **Sync Source**, the location at which reverse playback starts will be indeterminate.

Note: resetting the delay (using **Sync Source**) while reverse playback is still being heard may cause noise artifacts.

For drums or short phrases, you'll need to adjust **Reverse Time** appropriately in order to use this effectively.

## OUTPUT

This is the standard effects output section, with modulatable control over wet/dry balance. For more information, see "OUTPUT" on page 890.

## 088: Hold Delay

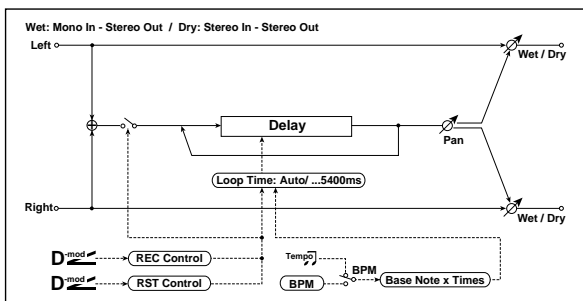

This effect records the input signal and plays it back as a loop, with overdub recording for creating multiple layers. You can use modulation sources to record and clear the loop, for simple real-time performance. The delay can sync to the system tempo, and is long enough for 2 measures of 4/4 at 90 bpm.

### REC CONTROL

You can start recording by using a Dmod source, or by manually pressing the on-screen **Manual Rec Control** check-box. Recording always overdubs with the existing loop; to clear the loop, use "RESET CONTROL," below.

**Source** [Off...Tempo]

This selects a modulation source to enable and disable recording. Modulation values of 64 or higher turn recording on; values of 63 or lower turn it off.

**Manual Rec Control** [Check-box]

This check-box lets you turn on recording manually, without using a controller. Just check the box to start recording, and un-check it to stop.

### RESET CONTROL

Resetting erases the audio from the loop, making it silent and letting you start again from scratch. As with recording, you can reset using a Dmod source or an on-screen check-box.

If the **Loop Time** is set to Auto, it will be reset as well.

**Source** [Off...Tempo]

This selects a modulation source for Reset. Modulation values of 64 or higher will start the Reset; values of 63 or lower have no effect. You don't have to hold the modulation for the entire duration of the loop, but do make sure to hold it for about half a second, to ensure that the loop is completely cleared.

**Manual Reset Control** [Check-box]

This check-box manually resets the loop.

## HOLD DELAY

**Loop Time** [msec] [Auto, 1...5400]

This applies only when **MIDI/Tempo Sync** is off.

With **Auto**, the loop time is automatically set to the length of the recorded phrase, up to a maximum of 5,400msec.

1...5400 sets a specific time in milliseconds.

**MIDI/Tempo Sync** [Check-box]

This specifies whether delay time is set in milliseconds, or as a note value relative to tempo.

**BPM** [MIDI, 40.00...300.00]

MIDI syncs to the system tempo; 40-240 sets the tempo manually for this individual effect.

**Time Over?** > [---, OVER!]

The maximum delay time is 5,400msec. If the combination of **BPM**, **Base Note**, and **Times** exceeds this limit, the error message "OVER!" will appear. If this occurs, change the delay time parameters so that this message no longer appears.

**Base Note** [♪...♩]

This sets the basic length of the loop, relative to the BPM setting. The values range from a 32nd note to a whole note, including triplets.

**Times** [x1...x32]

This multiplies the length of the Base Note. For instance, if the Base Note is set to a whole note, and Times is set to 32 the loop will last for two measures.



**Pan**  [L100...L1, C, R1...R100]

Sets the stereo position of the effect output.

**Source** [Off...Tempo]

Selects the modulation source for **Pan**.

**Amount** [+/-100]

Sets the modulation amount for **Pan**.

## OUTPUT

This is the standard effects output section, with modulatable control over wet/dry balance. For more information, see "OUTPUT" on page 890.

## Using the Hold Delay

Recording layered loops with the Hold Delay is easy. To do so:

1. On the IFX Insert FX page, select the Hold Delay effect.

This is an easy way to get to the default effects settings, which we'll be using:

- **REC Source:** JS +Y: CC#01
- **Reset Source:** JS -Y: CC#02
- **Manual Rec Control:** Off

- **Manual Reset Control:** Off
- **Loop Time [msec]:** Auto
- **MIDI/Tempo Sync:** Off

2. Push the main joystick (not the Vector Joystick) in the +Y direction (away from you).

This starts the recording.

3. Play a phrase.

4. Release the joystick to its original position.

This stops the recording. The phrase will now start to loop. Since **Loop Time** is set to **Auto**, the loop's duration will match that of the recording.

5. Push the main joystick in the +Y direction again.

6. Play another phrase, over the loop.

7. Release the joystick to its original position.

Now, you should hear what you just played layered over the first loop. You can overdub as many passes as you like.

To clear the loop and start over:

8. Pull the joystick in the -Y direction (towards you).

### Hold Delay is mono

The Hold Delay uses a single, long, mono delay line (although you can control the pan of the delay). For best results with stereo effects, such as chorus and reverb, use the stereo effects after the Hold Delay.

## 089: Auto Reverse

This effect records the input signal and automatically plays it in reverse (the effect is similar to a tape reverse sound).

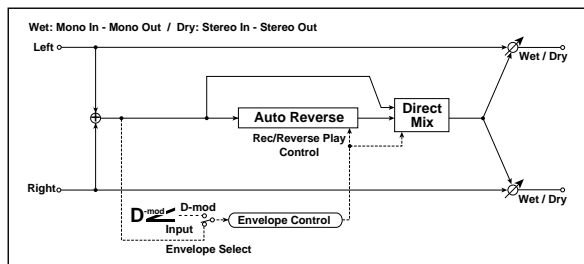

## CONTROL

**Envelope Select**  [Dmod, Input]

This selects whether the start and end of recording is controlled via the modulation source or the input signal level. After recording is completed, the reverse playback starts immediately.

**Dmod:** the input signal will be recorded only when the value of the specified modulation **Source** is 64 or higher.

**Input:** the input signal will be recorded only when its level exceeds the **Threshold** level.

**Source** [Off...Tempo]

Selects the modulation source that controls recording when **Envelope Select** is set to **Dmod**.

**Threshold** [0...100]

Sets the recording start level when **Envelope Select** is set to **Input**.

**Response** [0...100]

This sets the speed of the response to the end of recording. Set a smaller value when you are recording a phrase or rhythm pattern, and set a higher value if you are recording only one note.

## REVERSE

**Mode** [Single, Multi]

When **Mode** is set to **Single**, you can set up to 2,640msec for **Reverse Time**. If recording starts during the reverse playback, the playback will be interrupted.

When **Mode** is set to **Multi**, you can make another recording during the reverse playback. However, the maximum **Reverse Time** is limited to 1,320msec.

If you wish to use this with longer phrases or rhythm patterns, set **Mode** to **Single**. If you don't need a long playback time, and want playback and record to overlap, set **Mode** to **Multi**.

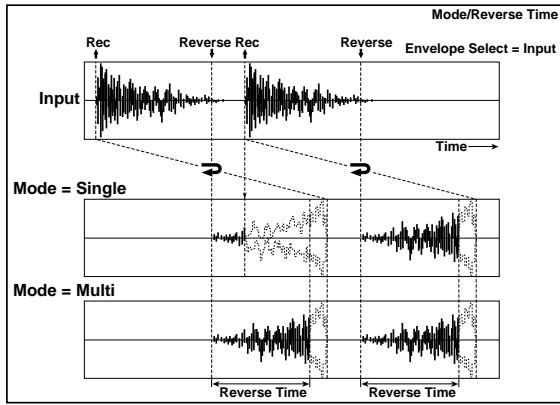

**Reverse Time [msec]** [20...2640]

This specifies the maximum time of the reverse playback. For short, single-note slapback effects, set the **Reverse Time** to a low value.

**Direct Mix [Always On, Always Off, Cross Fade]**

Selects how the dry sound is mixed. For more information, see "Direct Mix" on page 944.

**OUTPUT**

This is the standard effects output section, with modulatable control over wet/dry balance. For more information, see "OUTPUT" on page 890.

**090: Sequence BPM Delay**

This four-tap tempo delay includes a selection of patterns in 16th notes and dotted 8th notes.

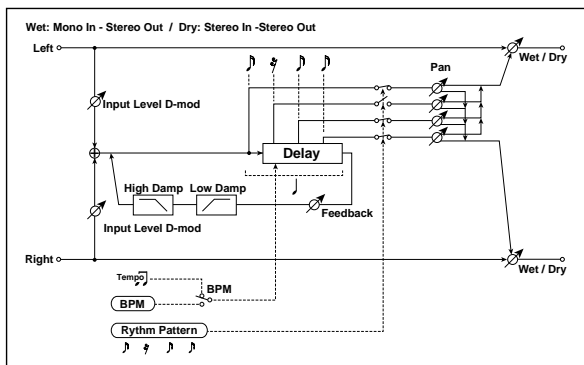

**Tap3 Pan** [L, 1...99, R]

Sets the panning of Tap3.

**Tap4 Pan** [L, 1...99, R]

Sets the panning of Tap4.

**Feedback D<sub>mod</sub>** [+/-100]

Sets the feedback amount. Negative values invert the phase.

**Source** [Off...Tempo]

Selects a Dmod source to modulate **Feedback**.

**Amount** [+/-100]

Sets the modulation amount for **Feedback**.

**High Damp [%]** [0...100]

Sets the amount of high-frequency attenuation for the feedback path.

**Low Damp [%]** [0...100]

Sets the amount of low-frequency damping for the feedback path.

**INPUT**

**Input Level Dmod [%]** D<sub>mod</sub> [+/-100]

Sets the modulation amount of the input level. p.951.

**Source** [Off...Tempo]

Selects the modulation source for the input level. p.951.

**DELAY**

**BPM** [MIDI, 40.00...300.00]

MIDI syncs to the system tempo; 40-240 sets the tempo manually for this individual effect. p.972.

When BPM is set to MIDI, the minimum tempo is 44BPM.

**Rhythm Pattern** [Musical Notation]

This parameter automatically creates rhythmic patterns by controlling the tap delay times and turning individual taps on and off. You can customize the patterns by using the feedback amount and per-tap pan controls, below.

The feedback time is always a quarter-note.

**Tap1 Pan** [L, 1...99, R]

Sets the panning of Tap1.

**Tap2 Pan** [L, 1...99, R]

Sets the panning of Tap2.

**OUTPUT**

This is the standard effects output section, with modulatable control over wet/dry balance. For more information, see "OUTPUT" on page 890.

## 091: L/C/R BPM Delay

The L/C/R delay enables you to match the delay time with the song tempo. You can also synchronize the delay time with the arpeggiator or sequencer. If you program the tempo before performance, you can achieve a delay effect that synchronizes with the song in real-time. Delay time is set by notes.

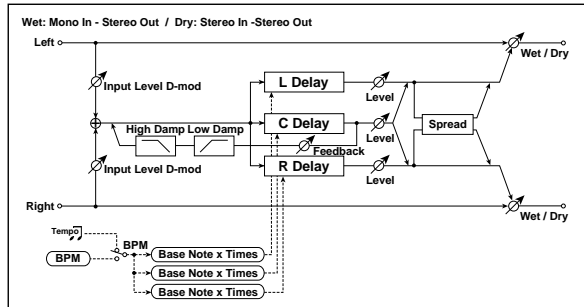

### INPUT

**Input Level Dmod [%]** **[+/-100]**

Sets the modulation amount of the input level. p.951.

**Source** **[Off...Tempo]**

Selects the modulation source for the input level. p.951.

### DELAY

**BPM** **[MIDI, 40.00...300.00]**

MIDI syncs to the system tempo; 40-240 sets the tempo manually for this individual effect.

**Time Over?>** **[---, OVER!]**

The maximum delay time is 2,730msec. If the combination of **BPM**, **Base Note**, and **Times** exceeds this limit, the error message "OVER!" appears in the display. If this occurs, change the delay time parameters so that this message no longer appears.

**L Delay Base Note** **[♪... ]**

This sets the basic length of the Left Delay, relative to the BPM setting. The values range from a 32nd note to a whole note, including triplets.

**Times** **[x1...x32]**

This multiplies the length of the Base Note. For instance, if the Base Note is set to a sixteenth note, and Times is set to 3, the delay length will be a dotted eighth note.

**Level** **[0...50]**

Sets the output level of the Left Delay.

**C Delay Base Note** **[♪... ]**

This sets the basic length of the Center Delay, relative to the BPM setting.

**Times** **[x1...x32]**

This multiplies the length of the Center Delay's Base Note.

**Level** **[0...50]**

Sets the output level of the Center Delay.

**R Delay Base Note** **[♪... ]**

This sets the basic length of the Right Delay, relative to the BPM setting.

**Times** **[x1...x32]**

This multiplies the length of the Right Delay's Base Note.

**Level** **[0...50]**

Sets the output level of the Right Delay.

**Feedback (C Delay)** **[+/-100]**

Sets the amount of feedback from the Center Delay.

**Source** **[Off...Tempo]**

Selects the modulation source for the Center Delay feedback.

**Amount** **[+/-100]**

Sets the modulation amount of the Center Delay feedback.

**High Damp [%]** **[0...100]**

Sets the amount of high-frequency attenuation for the feedback path.

**Low Damp [%]** **[0...100]**

Sets the amount of low-frequency attenuation for the feedback path.

**Spread** **[0...50]**

Sets the width of the stereo image of the effect sound. For more information, see "Spread" on page 961.

### OUTPUT

This is the standard effects output section, with modulatable control over wet/dry balance. For more information, see "OUTPUT" on page 890.

## 092: L/C/R BPM Long Delay

The L/C/R delay enables you to match the delay time with the song tempo. You can set the delay time up to 5,460msec

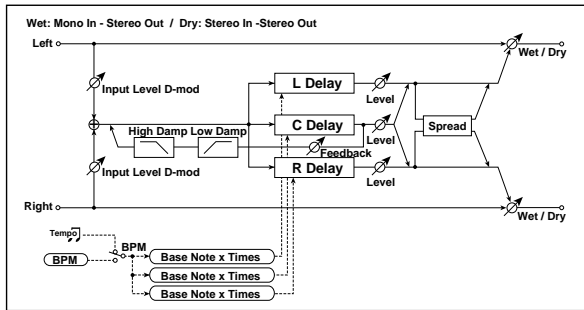

### INPUT

**Input Level Dmod [%]** **[+/-100]**

Sets the modulation amount of the input level. p.951.

**Source** **[Off...Tempo]**

Selects the modulation source for the input level. p.951.

### DELAY

**BPM** **[MIDI, 40.00...300.00]**

MIDI syncs to the system tempo; 40-240 sets the tempo manually for this individual effect.

**Time Over?>** **[---, OVER!]**

The maximum delay time is 5,460msec. If the combination of **BPM**, **Base Note**, and **Times** exceeds this limit, the error message "OVER!" appears in the display. If this occurs, change the delay time parameters so that this message no longer appears.

**L Delay Base Note** **[♪... ]**

This sets the basic length of the Left Delay, relative to the BPM setting. The values range from a 32nd note to a whole note, including triplets.

**Times** **[x1...x32]**

This multiplies the length of the Base Note. For instance, if the Base Note is set to a sixteenth note, and Times is set to 3, the delay length will be a dotted eighth note.

**Level** **[0...50]**

Sets the output level of the Left Tap.

**C Delay Base Note** **[♪... ]**

This sets the basic length of the Center Delay, relative to the BPM setting.

**Times** **[x1...x32]**

This multiplies the length of the Center Delay's Base Note.

**Level** **[0...50]**

Sets the output level of the Center Delay.

**R Delay Base Note** **[♪... ]**

This sets the basic length of the Right Delay, relative to the BPM setting.

**Times** **[x1...x32]**

This multiplies the length of the Right Delay's Base Note.

**Level** **[0...50]**

Sets the output level of the Right Delay.

**Feedback (C Delay)** **[+/-100]**

Sets the feedback amount of the Center Delay.

**Source** **[Off...Tempo]**

Selects a source to modulate the Center Delay feedback.

**Amount** **[+/-100]**

Sets the Center Delay feedback modulation amount.

**High Damp [%]** **[0...100]**

Sets the amount of high-frequency attenuation for the feedback path.

**Low Damp [%]** **[0...100]**

Sets the amount of low-frequency attenuation for the feedback path.

**Spread** **[0...50]**

Sets the width of the stereo image of the effect sound. For more information, see "Spread" on page 961.

### OUTPUT

This is the standard effects output section, with modulatable control over wet/dry balance. For more information, see "OUTPUT" on page 890.

## 093: Stereo BPM Delay

This stereo delay enables you to set the delay time to match the song tempo. Fine adjustment lets you change the rhythmic feel of the delays.

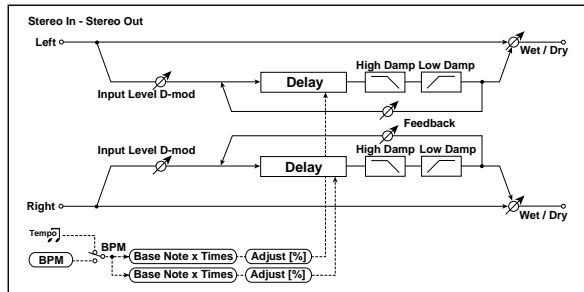

### INPUT

**Input Level Dmod [%]** **[+/-100]**

Sets the modulation amount for the input level. For more information, see "Input Level Dmod [%]" on page 951.

**Source** **[Off...Tempo]**

Selects the modulation source for the input level.

### DELAY

**BPM** **[MIDI, 40.00...300.00]**

MIDI syncs to the system tempo; 40-240 sets the tempo manually for this individual effect.

**Time Over? L >** **[---, OVER!]**

**Time Over? R >** **[---, OVER!]**

The maximum delay time is 1,360msec per channel (left and right). If the channel's combination of **BPM**, **Base Note**, and **Times** exceeds this limit, the error message "OVER!" will appear. If this occurs, change the delay time parameters so that this message no longer appears.

**L Delay Base Note** **[♪... ]**

This sets the basic length of the Left Delay, relative to the BPM setting. The values range from a 32nd note to a whole note, including triplets.

**Times** **[x1...x32]**

This multiplies the length of the Base Note. For instance, if the Base Note is set to a sixteenth note, and Times is set to 3, the delay length will be a dotted eighth note.

**Adjust [%]** **[-2.50...+2.50]**

This adjusts the left channel delay time by up to 2.5% in either direction, for subtle control over the feel of the delay.

**R Delay Base Note** **[♪... ]**

This sets the basic length of the Right Delay, relative to the BPM setting.

**Times** **[x1...x32]**

This multiplies the length of the Right Delay's Base Note.

**Adjust [%]** **[-2.50...+2.50]**

Fine-adjust the right channel delay time.

**L Feedback** **[+/-100]**

Sets the feedback amount for the left channel.

**R Feedback** **[+/-100]**

Sets the feedback amount for the right channel.

**Source** **[Off...Tempo]**

Selects the modulation source of feedback amount.

**L Amount** **[+/-100]**

Sets the modulation amount of the left channel feedback.

**R Amount** **[+/-100]**

Sets the modulation amount of the right channel feedback.

**High Damp [%]** **[0...100]**

Sets the amount of high-frequency attenuation for the feedback path.

**Low Damp [%]** **[0...100]**

Sets the amount of low-frequency attenuation for the feedback path.

### OUTPUT

This is the standard effects output section, with modulatable control over wet/dry balance. For more information, see "OUTPUT" on page 890.

## 094: Stereo BPM Long Delay

The stereo delay enables you to match the delay time with the song tempo. You can set the delay time up to 2,730msec.

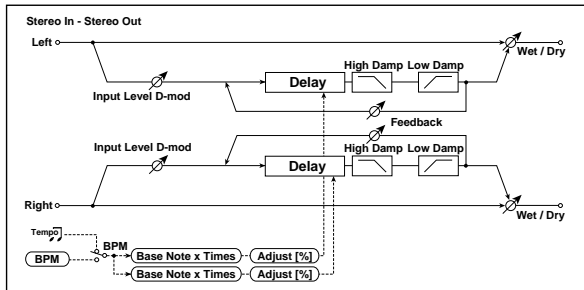

### INPUT

**Input Level Dmod [%]** **[+/-100]**

Sets the modulation amount for the input level. For more information, see “Input Level Dmod [%]” on page 951.

**Source** **[Off...Tempo]**

Selects the modulation source for the input level.

### DELAY

**BPM** **[MIDI, 40.00...300.00]**

MIDI syncs to the system tempo; 40-240 sets the tempo manually for this individual effect.

**Time Over? L >** **[---, OVER!]**

**Time Over? R>** **[---, OVER!]**

The maximum delay time is 2,730msec per channel (left and right). If the channel’s combination of **BPM**, **Base Note**, and **Times** exceeds this limit, the error message “OVER!” will appear. If this occurs, change the delay time parameters so that this message no longer appears.

**L Delay Base Note** **[♪...♩]**

This sets the basic length of the Left Delay, relative to the BPM setting. The values range from a 32nd note to a whole note, including triplets.

**Times** **[x1...x32]**

This multiplies the length of the Base Note. For instance, if the Base Note is set to a sixteenth note, and Times is set to 3, the delay length will be a dotted eighth note.

**Adjust [%]** **[-2.50...+2.50]**

This adjusts the left channel delay time by up to 2.5% in either direction, for subtle control over the feel of the delay.

**R Delay Base Note** **[♪...♩]**

This sets the basic length of the Right Delay, relative to the BPM setting.

**Times** **[x1...x32]**

This multiplies the length of the Right Delay’s Base Note.

**Adjust [%]** **[-2.50...+2.50]**

Fine-adjust the right channel delay time.

**L Feedback** **[+/-100]**

Sets the feedback amount for the left channel.

**R Feedback** **[+/-100]**

Sets the feedback amount for the right channel.

**Source** **[Off...Tempo]**

Selects the modulation source of feedback amount.

**L Amount** **[+/-100]**

Sets the modulation amount of the left channel feedback.

**R Amount** **[+/-100]**

Sets the modulation amount of the right channel feedback.

**High Damp [%]** **[0...100]**

Sets the damping amount in the high range. For more information, see “High Damp [%]” on page 961.

**Low Damp [%]** **[Korg0...100]**

Sets the damping amount in the low range. For more information, see “Low Damp [%]” on page 961.

### OUTPUT

This is the standard effects output section, with modulatable control over wet/dry balance. For more information, see “OUTPUT” on page 890.

## 095: Stereo BPM Multitap Delay

This four-tap delay enables you to select a tempo and rhythm pattern to set up each tap.

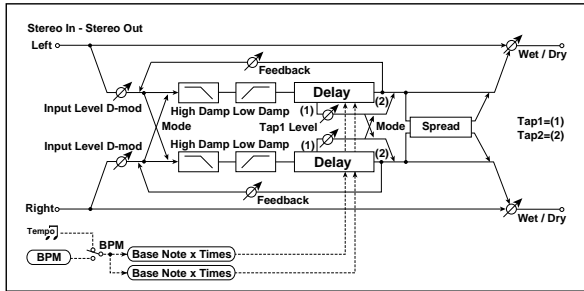

### INPUT

**Input Level Dmod [%]** **[+/-100]**

Sets the modulation amount for the input level. For more information, see "Input Level Dmod [%]" on page 951.

**Source** **[Off...Tempo]**

Selects the modulation source for the input level.

### DELAY

**BPM** **[MIDI, 40.00...300.00]**

MIDI syncs to the system tempo; 40-240 sets the tempo manually for this individual effect.

**Time Over?>** **[---, OVER!]**

The maximum delay time is 1,360msec. If the combination of **BPM**, **Base Note**, and **Times** exceeds this limit, the error message "OVER!" will appear. If this occurs, change the delay time parameters so that this message no longer appears.

**Mode** **[Normal, Cross Feedback, Cross Pan1, Cross Pan2]**

Switches the left and right delay routing. For more information, see "Mode" on page 963.

**Tap 1 Base Note** **[♪... ]**

This sets the basic length of the Tap 1, relative to the BPM setting. The values range from a 32nd note to a whole note, including triplets.

**Times** **[x1...x32]**

This multiplies the length of the Base Note. For instance, if the Base Note is set to a sixteenth note, and Times is set to 3, the delay length will be a dotted eighth note.

**Tap 2 Base Note** **[♪... ]**

This sets the basic length of Tap 2, relative to the BPM setting.

**Times** **[x1...x32]**

This multiplies the length of Tap 2's Base Note.

**Feedback (Tap2)** **[+/-100]**

Sets the Tap 2 feedback amount.

**Source** **[Off...Tempo]**

Selects the modulation source of the Tap 2 feedback amount.

**Amount** **[+/-100]**

Sets the modulation amount of the Tap 2 feedback amount.

**Tap1 Level** **[0...100]**

Sets the Tap1 output level. For more information, see "Tap1 Level" on page 964.

**High Damp [%]** **[0...100]**

Sets the amount of high-frequency attenuation.

**Low Damp [%]** **[0...100]**

Sets the amount of low-frequency attenuation.

**Spread** **[+/-100]**

Sets the width of the stereo image of the effect sound. For more information, see "Spread" on page 961.

**Source** **[Off...Tempo]**

Selects the modulation source of the effect sound's stereo image width.

**Amount** **[+/-100]**

Sets the modulation amount of the effect sound's stereo image width.

### OUTPUT

This is the standard effects output section, with modulatable control over wet/dry balance. For more information, see "OUTPUT" on page 890.



## 096: Stereo BPM Mod. Delay

This stereo tempo delay uses either an LFO or a Dmod source to modulate the delay time. This causes the delay's pitch to vary, creating an effect which swells and shimmers like a cross between an echo and a chorus.

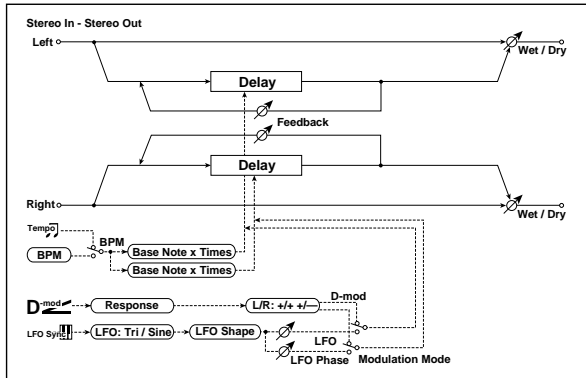

### CONTROL

**Modulation Mode** [LFO, Dmod]

This selects whether the delay time will be swept by the LFO or by the selected Dmod source.

**Dmod Modulation** [L/R: +/+, L/R: +/-]

This applies only if **Modulation Mode** is set to **Dmod**.

**L/R: +/+**: the Dmod source modulates both left and right delays equally.

**L/R: +/-**: the Dmod source modulates left and right inversely, for a deeper stereo effect.

**Source** [Off...Tempo]

Selects a modulation source to control the delay time. This applies only if **Modulation Mode** is set to **Dmod**.

**Response** [0...30]

This controls how quickly the delay times change in response to the modulation source. Higher values mean faster response times.

### LFO

All of the LFO controls apply only when the **Modulation Mode** is set to **LFO**.

**Waveform** [Triangle, Sine]

Selects the LFO Waveform.

**Shape** [+/-100]

Changes the curvature of the LFO Waveform. For more information, see "Shape" on page 910.

**L LFO Phase [degrees]** [-180...+180]

This sets the initial phase of the left LFO. The relationship between this and the **R LFO Phase** controls the depth of the stereo effect and the richness of the pitch changes. As a start, try setting one to +90 and the other to -90.

**R LFO Phase [degrees]** [-180...+180]

This sets the initial phase of the right LFO.

**Dmod Sync** [Check-box]

This enables reset of the LFOs from a Dmod source, as selected below.

**Source** [Off...Tempo]

If **Dmod Sync** is **On**, this selects the modulation source to reset the LFOs, using the initial phases set by **L LFO Phase** and **R LFO Phase** above.

For example, if you set the **Source** to **Gate 2**, playing on the keyboard will reset the LFOs so that the modulation sounds the same at the start of each phrase.

**MIDI** The LFOs are reset when the modulation value changes from 63 or smaller to 64 or higher.

**Frequency [Hz]** [0.02...20.00]

This sets the LFO speed, in Hz. It applies only when **MIDI/Tempo Sync**, below, is **Off**.

**MIDI/Tempo Sync** [Check-box]

**BPM** [MIDI, 40.00...300.00]

**Base Note** [Musical Notation]

**Times** [x1...x32]

When **MIDI/Tempo Sync** is on, the LFO speed is set by **BPM**, **Base Note**, and **Times**, instead of **Frequency**. For more information, see "MIDI/Tempo Sync" on page 907.

**Type** [Individual, Common1, Common2]

This controls whether the effect uses its individual LFO, or one of the Common FX LFOs. For more information, see "LFO Type" on page 907.

**Common LFO Phase Offset [degrees]** [+/-180]

When **Type** is set to **Common FX LFO 1** or **2**, this lets you offset the phase from the master LFO.

### MOD DELAY

**BPM** [MIDI, 40.00...300.00]

MIDI syncs to the system tempo; 40-240 sets the tempo manually for this individual effect.

**Time Over? L >** [---, OVER!]

**Time Over? R >** [---, OVER!]

The maximum delay time is 1,000msec per channel (left and right). If the channel's combination of **BPM**, **Base Note**, and **Times** exceeds this limit, the error message "OVER!" will appear. If this occurs, change the delay time parameters so that this message no longer appears.

**L Delay Base Note** [Musical Notation]

This sets the basic length of the Left Delay, relative to the BPM setting. The values range from a 32nd note to a whole note, including triplets.

**Times** [x1...x32]

This multiplies the length of the Base Note. For instance, if the Base Note is set to a sixteenth note, and Times is set to 3, the delay length will be a dotted eighth note.

**R Delay Base Note** [MIDI Note]

This sets the basic length of the Right Delay, relative to the BPM setting.

**Times** [x1...x32]

This multiplies the length of the Right Delay's Base Note.

**L Depth** [0...200]

Sets the amount of pitch modulation for the left channel. 0...100 produce chorus-like effects; over 100 produces more obvious pitch-shifting.

**R Depth** [0...200]

Sets the amount of pitch modulation for the right channel.

**L Feedback** [+/-100]

Sets the amount of feedback for the left delay. Negative values invert the phase.

**R Feedback** [+/-100]

Sets the amount of feedback for the right delay.

**OUTPUT**

This is the standard effects output section, with modulatable control over wet/dry balance. For more information, see "OUTPUT" on page 890.

**097: St. BPM Auto Panning Dly**

This stereo auto panning delay enables you to set the delay time to match the song tempo.

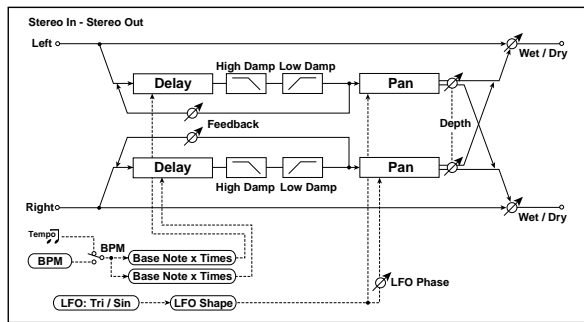

**DELAY**

**BPM** [MIDI, 40.00...300.00]

MIDI syncs to the system tempo; 40-240 sets the tempo manually for this individual effect.

**Time Over? L >** [---, OVER!]

**Time Over? R >** [---, OVER!]

The maximum delay time is 1,360msec per channel (left and right). If the channel's combination of BPM, Base Note, and Times exceeds this limit, the error message "OVER!" will appear. If this occurs, change the delay time parameters so that this message no longer appears.

**L Delay Base Note** [MIDI Note]

This sets the basic length of the Left Delay, relative to the BPM setting. The values range from a 32nd note to a whole note, including triplets.

**Times** [x1...x32]

This multiplies the length of the Base Note. For instance, if the Base Note is set to a sixteenth note, and Times is set to 3, the delay length will be a dotted eighth note.

**R Delay Base Note** [MIDI Note]

This sets the basic length of the Right Delay, relative to the BPM setting.

**Times** [x1...x32]

This multiplies the length of the Right Delay's Base Note.

**L Feedback** [+/-100]

Sets the feedback amount for the left channel.

**R Feedback** [+/-100]

Sets the feedback amount for the right channel.

**High Damp [%]** [0...100]

Sets the amount of high-frequency attenuation.

**Low Damp [%]** [0...100]

Sets the amount of low-frequency attenuation.

**LFO**

**Waveform** [Triangle, Sine]

Selects the LFO Waveform.

**Shape** [+/-100]

Changes the curvature of the LFO Waveform. For more information, see "Shape" on page 910.

**Phase [degrees]** [-180...+180]

Sets the LFO phase difference between the left and right. For more information, see "Phase [degrees]" on page 945.

**Frequency [Hz]** [0.02...20.00]

This sets the LFO speed, in Hz. It applies only when MIDI/Tempo Sync, below, is Off.

**MIDI/Tempo Sync**  **[Check-box]**

**BPM** **[MIDI, 40.00...300.00]**

**Base Note**  **[...]**

**Times** **[x1...x32]**

When **MIDI/Tempo Sync** is on, the LFO speed is set by **BPM**, **Base Note**, and **Times**, instead of **Frequency**. For more information, see “MIDI/Tempo Sync” on page 907.

**Type** **[Individual, Common1, Common2]**

This controls whether the effect uses its individual LFO, or one of the Common FX LFOs. For more information, see “LFO Type” on page 907.

**Common LFO Phase Offset [degrees]** **[+/-180]**

When Type is set to **Common FX LFO 1** or **2**, this lets you offset the phase from the master LFO.

## 098: Tape BPM Echo

This models a tape echo unit with three playback heads—but with the ability to sync to tempo. The distortion and tonal changes typical of magnetic tape are also reproduced.

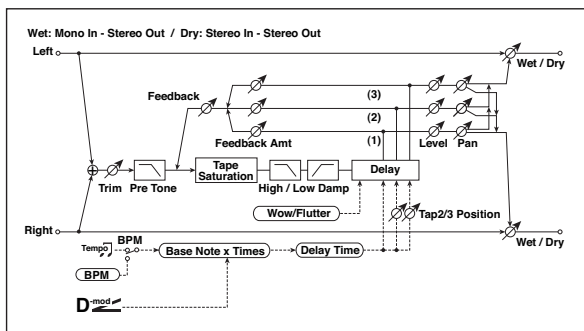

### INPUT

**Trim** **[0...100]**

Sets the input gain.

**Pre Tone** **[0...100]**

This models the reduced high frequencies of an analog tape delay, before the saturation stage. Lower settings create a darker tone.

### WOW & FLUTTER

This section models the instability of the tape machine’s motors. As the speed of the motor fluctuates, the pitch changes slightly. This introduces a pleasant chorus-like effect.

**Frequency [Hz]** **[0.02...1.00]**

Sets the frequency at which pitch variation occurs.

**Depth** **[0...100]**

Sets the depth of the pitch change.

### AUTO PAN

**Depth**  **[0...100]**

Sets the panning width.

**Source** **[Off...Tempo]**

Selects the modulation source for the panning width.

**Amount** **[+/-100]**

Set the modulation amount of the panning width.

### OUTPUT

This is the standard effects output section, with modulatable control over wet/dry balance. For more information, see “OUTPUT” on page 890.

## TAPE ECHO

### Delay Time

**BPM**  **[MIDI, 40.00...300.00]**

MIDI syncs to the system tempo; 40-240 sets the tempo manually for this individual effect. p.953.

**Time Over? >** **[---, OVER!]**

The maximum delay time is 2,700msec. If the combination of **BPM**, **Base Note**, and **Times** exceeds this limit, the error message “OVER!” will appear. If this occurs, change the delay time parameters so that this message no longer appears.

**Delay(Tap1) Note**   **[...]**

This sets the basic delay time of Tap 1, relative to the system tempo. The values range from a 32nd note to a whole note, including triplets.

Also, Taps 2 and 3 are specified as a percentage (%) of this delay time. Taps 2 and 3 always stay in proportion to Tap 1, even when the delay time is modulated.

**Times** **[x1...x32]**

This multiplies the length of the Base Note. For instance, if the Base Note is set to a sixteenth note, and Times is set to 3, the delay time will be a dotted eighth note.

**Source** **[Off...Tempo]**

Selects the modulation source for the delay **Note** and **Times**.

**Dmod Max Note**   **[...]**

Instead of specifying a modulation intensity, you can specify a note (and multiplier) to map to the maximum modulation value. Note that these can each be either longer or shorter than the original **Note** and **Times**.

**Times** **[x1...x32]**

This sets the multiplier for the **Dmod Max Note**.

**Tap2 Position [%]** [0...100]

Sets the delay time of Tap 2, as a percentage of Tap 1's delay time.

**Tap3 Position [%]** [0...100]

Sets the delay time of Tap 3, as a percentage of Tap 1's delay time.

**Level and Pan 1...3**

Each tap has its own controls for level and pan.

**Tap1...3 Level** [0...100]

Sets the tap's output level.

**Pan** [L, 1...99, R]

Sets the tap's stereo position.

**Feedback**

**Tap1...3 Feedback Amount** [+/-100]

Sets the individual tap's feedback level. Negative values invert the phase. These individual levels are summed together, and then the final level is controlled by **Feedback Level**, below.

**Feedback Level**  $D_{mod}$  [0...100]

Sets the overall level of feedback.

**Source** [Off...Tempo]

Selects the modulation source for the **Feedback Level**.

**Amount** [+/-100]

Sets the modulation amount for the **Feedback Level**.

**Tone**

**High Damp [%]** [0...100]

This cuts the high frequencies in both the main output and the feedback. Higher settings create a darker tone.

**Low Damp [%]** [0...100]

This cuts the low frequencies in both the main output and the feedback. Higher settings mean less low-end.

**Saturation** [0...100]

This models the distortion of an analog tape delay.

**OUTPUT**

This is the standard effects output section, with modulatable control over wet/dry balance. For more information, see "OUTPUT" on page 890.

**099: Reverse BPM Delay**

This is a reverse-playback delay that lets you synchronize the delay time to the tempo of the song.

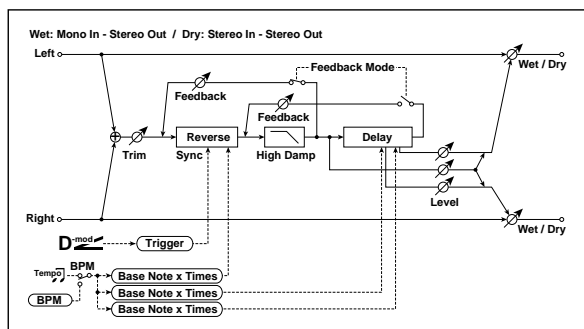

**INPUT**

**Input Level Dmod [%]**  $D_{mod}$  [+/-100]

Sets the modulation amount of the input level.

**Source** [Off...Tempo]

Selects the modulation source for the input level.

**REVERSE DELAY**

**BPM**  $BPM$  [MIDI, 40.00...300.00]

MIDI syncs to the system tempo; 40-240 sets the tempo manually for this individual effect.

**Time Over? >** [---, OVER!]

The maximum delay time is 900msec. If the combination of **BPM**, **Base Note**, and **Times** exceeds this limit, the error message "OVER!" will appear. If this occurs, change the delay time parameters so that this message no longer appears.

**Reverse Base Note**  $B_{rev}$  [♪...♪]

This sets the basic length of the Reverse Delay, relative to the BPM setting. The values range from a 32nd note to a whole note, including triplets.

**Times** [x1...x32]

This multiplies the length of the Base Note. For instance, if the Base Note is set to a sixteenth note, and Times is set to 3, the delay length will be a dotted eighth note.

**Level** [0...100]

Sets the output level of the reverse playback.

**R Delay Base Note**  $B_{R}$  [♪...♪]

This sets the basic length of the Right Delay, relative to the BPM setting.

**Times** [x1...x32]

This multiplies the length of the Right Delay's Base Note.

**L Post-Delay Base Note**  $B_{L}$  [♪...♪]

This sets the basic length of the Left Post-Delay, relative to the BPM setting.

**Times** [x1...x32]

This multiplies the length of the Left Post-Delay's Base Note.

**Level** [0...100]

Sets the output level of the Left Post-Delay.

**R Post-Delay Base Note**  [ ]

This sets the basic length of the Right Post-Delay, relative to the BPM setting.

**Times** [x1...x32]

This multiplies the length of the Right Post-Delay's Base Note.

**Level** [0...100]

Sets the output level of the Right Post-Delay.

**Feedback Mode** [Reverse, Reverse/Forward]

Selects the feedback mode: reverse playback, or alternating reverse and forward playback. For more information, see "Feedback Mode" on page 969.

**Feedback**  [+/-100]

Sets the feedback amount.

**Source** [Off...Tempo]

Selects the modulation source of feedback amount.

**Amount** [+/-100]

Sets the feedback amount.

**High Damp [%]** [0...100]

Sets the amount of high-frequency attenuation.

**Sync Source**  [Off...Tempo]

Selects the modulation source that will reset the point at which the sound is captured for reverse playback. For more information, see "Reverse Time and Sync Source" on page 969.

---

**OUTPUT**

This is the standard effects output section, with modulatable control over wet/dry balance. For more information, see "OUTPUT" on page 890.

# Reverb and Early Reflections

## 100: Overb

The Overb features a high-quality, diffusion-based reverb core. In addition to setting the size of the room, you can model its shape and materials by adjusting the diffusion characteristics of both the initial reflections and the main reverberant wash, and via separate controls for the high, mid, and low decay times. The Overb also includes randomization, for richer and smoother reverb timbres.

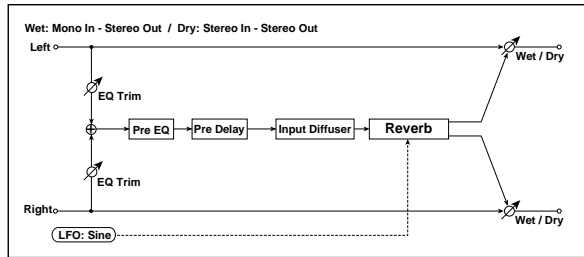

### Pre EQ

There are two fully parametric bands of peaking EQ, for adjusting the reverb timbre. These affect only the reverb, and not the dry signal. Both bands have identical parameters.

**Trim** [0...100]

Sets the EQ input level.

### Band 1

**Band1** [Check-box]

Switches the first band of EQ band on and off.

**Fc [Hz]** [200...20.0k]

Sets the center frequency of Band 1.

**Q** [0.5...10.0]

Sets the bandwidth of Band 1.

**Gain [dB]** [-18.0...+18.0]

Sets the gain of Band 1.

### Band 2

Band 2 has the same parameters as Band 1, above.

### Rolloff

**Rolloff** [0...100]

This controls a lowpass filter on the output of the effect. Settings around 6-8kHz are good for producing a warm, smooth sound.

## REVERB

**Pre Delay [msec]** [0...1360]

Sets the delay time from the dry sound.

**Diffusion1** [0...100]

**Diffusion 1** and **2** soften the sound before it enters the reverb core, shaping the timbre of the initial reflections. Setting both diffusers to around 50 generally produces sufficient diffusion for smooth reverbs; extremely high levels may cause ringing.

Some source material, such as vocals, may also benefit from lower settings of diffusion, allowing for more discrete echoes.

**Diffusion1** and **Diffusion2** differ in how the reflections are spaced, and the balance between these two parameters will vary the character of the reverb.

**Diffusion2** [0...100]

This is the second diffuser for the initial reflections. For more information, see "Diffusion1," above.

**Size** [5...100]

Sets the size of the space.

**Time** [0...100]

This sets the main reverberation time. The **Damping** and (bass) **Gain** parameters, below, let you adjust the decay times separately for the high and low frequencies, respectively.

**Diffusion** [0...100]

This sets the density of reflections within the main reverb. Low settings will produce more discrete echoes, and high settings will produce a smoother reverb. Extremely high settings may cause ringing.

*Reverb Size, Time, and Diffusion*

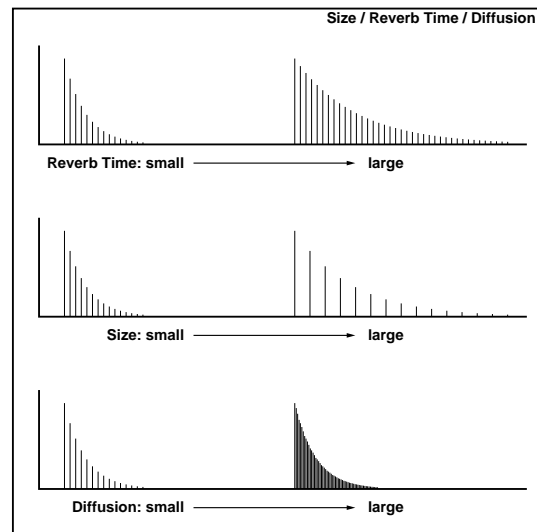

**Damping** [0...100]

This sets the cutoff of the high-frequency damping filter. If **Damping** is set to 100, the high frequencies will decay at the same rate as the low frequencies; at 0, the high frequencies will decay almost instantly.

In real acoustic spaces, high frequencies generally delay somewhat faster than low frequencies, so moderate amounts of damping will create a more realistic sound.

**Bass Crossover [Hz]** [20...24.00k]

Sets the crossover frequency for the Bass Gain.

**Gain [dB]** [-12.0...+6.0]

This lets you tailor the decay time of the reverb's low frequencies, using the frequency set by the Bass Crossover. Negative settings make the low frequencies decay faster than the main reverb; positive settings make them decay more slowly.

## 101: Reverb Hall

This hall-type reverb simulates the reverberation of mid-size concert halls or ensemble halls. For detailed explanations of the parameters, see "104: Reverb Dry Plate," below.

## 102: Reverb Smooth Hall

This hall-type reverb simulates the reverberation of larger halls and stadiums, and creates a smooth release. For detailed explanations of the parameters, see "104: Reverb Dry Plate," below.

## 103: Reverb Wet Plate

This plate reverb creates warm, dense reverberation. For detailed explanations of the parameters, see "104: Reverb Dry Plate," below.

## 104: Reverb Dry Plate

This plate reverb creates dry, light reverberation.

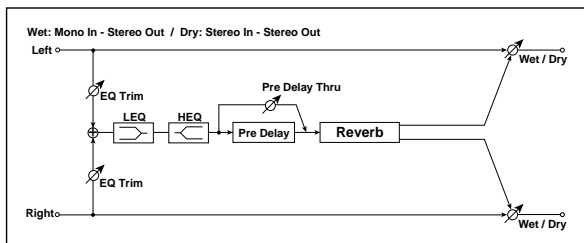

### Pre EQ

**Trim** [0...100]

Sets the EQ input level.

**LEQ Fc** [Low, Mid-Low]

Selects the cutoff frequency (low or mid-low) of the low-range equalizer.

### MODULATION

**Rate** [0.02...5.00]

The O-Verb includes randomization in the reverberant wash, to diminish resonant peaks and add a rich character to the sound. The **Rate** determines the speed of the randomization.

**Depth** [0...100]

This determines the intensity of the randomization.

### OUTPUT

This is the standard effects output section, with modulatable control over wet/dry balance. For more information, see "OUTPUT" on page 890.

**LEQ Gain [dB]** [-15.0...+15.0]

Sets the gain of the Low EQ.

**HEQ Fc** [High, Mid-High]

Selects the cutoff frequency (high or mid-high) of the high-range equalizer.

**HEQ Gain [dB]** [-15.0...+15.0]

Sets the gain of the High EQ.

### REVERB

**Reverb Time [sec]** [0.1...10.0]

Sets the reverberation time.

**High Damp [%]** [0...100]

Sets the amount of high-frequency attenuation.



**Pre Delay [msec] [0...200]**

The **Pre Delay** is not heard directly; it only affects the signal going to the reverb. Higher amounts of **Pre Delay** enhance the feeling of spaciousness, allowing the reverb to blossom a little after the initial sound.

**Pre Delay Thru [%] [0...100]**

The un-delayed input is mixed together with the **Pre Delay** output, and the result is fed into the reverb. **Pre Delay Thru** controls the level of the un-delayed input (the **Pre Delay** level is always at maximum). The mix of the delayed and un-delayed signals can create a more dense, natural timbre.

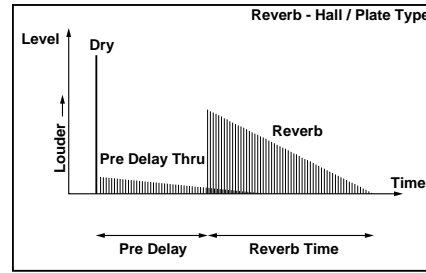

**OUTPUT**

This is the standard effects output section, with modulatable control over wet/dry balance. For more information, see "OUTPUT" on page 890.

**105: Reverb Room**

This room-type reverb emphasizes the early reflections that make the sound tighter. Changing the balance between the early reflections and reverb sound allows

you to simulate nuances, such as the type of walls of a room. For detailed explanations of the parameters, see "106: Reverb Bright Room" on page 985.

**106: Reverb Bright Room**

This room-type reverb emphasizes the early reflections that make the sound brighter. See 056: Reverb Room.

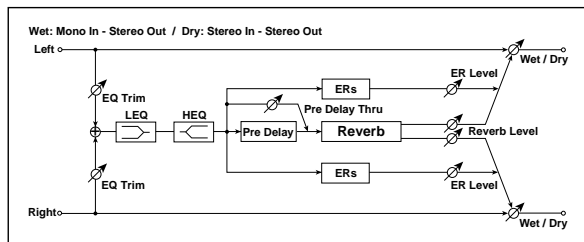

**Pre Delay [msec] [0...200]**

Sets the delay time from the dry sound. p.985.

**Pre Delay Thru [%] [0...100]**

Sets the mix ratio of non-delay sound. p.985.

**ER Level [0...100]**

Sets the level of early reflections. See "Reverb Level," below.

**Reverb Level [0...100]**

Sets the level of the main reverberation.

Together, the **ER Level** and **Reverb Level** allow you to model the type of walls in the room. A larger **ER Level** simulates a hard wall, and a larger **Reverb Level** simulates a soft wall.

**Pre EQ**

**Trim [0...100]**

Sets the EQ input level.

**LEQ Fc [Low, Mid-Low]**

Selects the cutoff frequency (low or mid-low) of the low-range equalizer.

**LEQ Gain [dB] [-15.0...+15.0]**

Sets the gain of the Low EQ.

**HEQ Fc [High, Mid-High]**

Selects the cutoff frequency (high or mid-high) of the high-range equalizer.

**HEQ Gain [dB] [-15.0...+15.0]**

Sets the gain of the High EQ.

**REVERB**

**Reverb Time [sec] [0.1...3.0]**

Sets the reverberation time.

**High Damp [%] [0...100]**

Sets the amount of high-frequency attenuation.

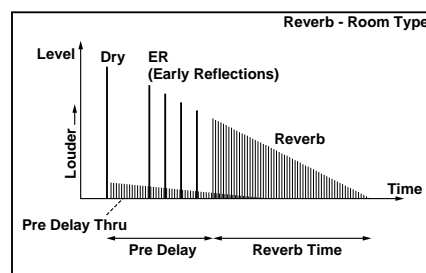

**OUTPUT**

This is the standard effects output section, with modulatable control over wet/dry balance. For more information, see "OUTPUT" on page 890.

## 107: Early Reflections

This effect is only the early reflection part of a reverberation sound, and adds presence to the sound. You can select one of the four decay curves.

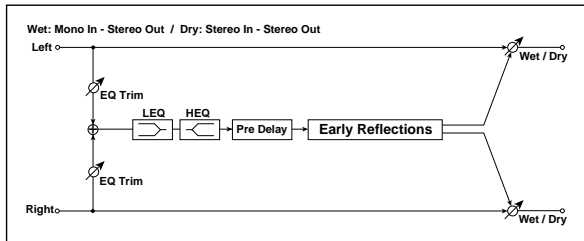

### Pre EQ

**Trim** [0...100]

Sets the input level of EQ applied to the effect sound.

**LEQ Fc** [Low, Mid-Low]

Selects the cutoff frequency (low or mid-low) of the low-range equalizer.

**LEQ Gain [dB]** [-15.0...+15.0]

Sets the gain of the Low EQ.

**HEQ Fc** [High, Mid-High]

Selects the cutoff frequency (high or mid-high) of the high-range equalizer.

**HEQ Gain [dB]** [-15.0...+15.0]

Sets the gain of the High EQ.

### EARLY REFLECTIONS

**Pre Delay [msec]** [0...200]

Sets the time taken from the original sound to the first early reflection.

**Type** [Sharp, Loose, Modulated, Reverse]

This parameter selects the decay curve for the early reflections.

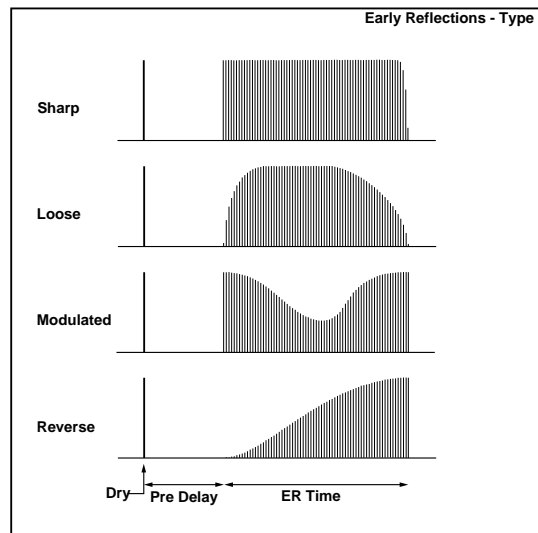

**ER Time [msec]** [10...800]

Sets the time length of early reflection.

### OUTPUT

This is the standard effects output section, with modulatable control over wet/dry balance. For more information, see "OUTPUT" on page 890.

## 108: Early Reflections Hi Dens

This early reflection effect has more precise early reflections with twice the maximum length of 107: Early Reflections. You can create a very smooth and dense sound.

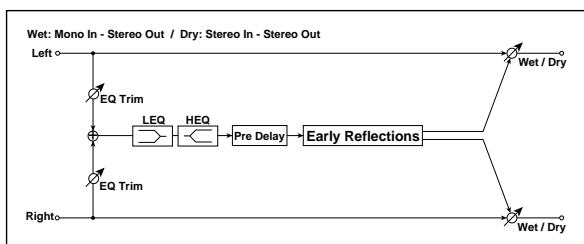

### Pre EQ

**Trim** [0...100]

Sets the input level of EQ applied to the effect sound.

**LEQ Fc** [Low, Mid-Low]

Selects the cutoff frequency (low or mid-low) of the low-range equalizer.

**LEQ Gain [dB]** [-15.0...+15.0]

Sets the gain of the Low EQ.

**HEQ Fc** [High, Mid-High]

Selects the cutoff frequency (high or mid-high) of the high-range equalizer.

**HEQ Gain [dB]** [-15.0...+15.0]

Sets the gain of the High EQ.

### EARLY REFLECTIONS

**Pre Delay [msec]** [0...200]

Sets the time taken from the original sound to the first early reflection.

**Type** [Sharp, Loose, Modulated, Reverse]

Selects the decay curve for the early reflections. For more information, see "Type" on page 986.

**ER Time [msec]** [10...1600]

Sets the time length of early reflection.

---

## OUTPUT

This is the standard effects output section, with modulatable control over wet/dry balance. For more information, see "OUTPUT" on page 890.

## Mono-Mono Serial

109: P4EQ - Exciter through 140: Reverb - Gate provide serial chains of mono effects. These include various combinations of EQ, Compressor, Limiter, Exciter, Overdrive, Wah, Chorus/Flanger, Phaser, Multitap Delay, Gate, and Reverb, as described below.

### PARAMETRIC EQ

For a description of the on-screen EQ graphic, see “011: Stereo Parametric 4EQ” on page 902.

**Trim** [0...100]

Sets the parametric EQ input level.

**Band1 Fc [Hz]** [20...1.00k]

Sets the center frequency of Band 1.

**Q** [0.5...10.0]

Sets the bandwidth of Band 1. For more information, please see “Q” on page 902.

**Gain [dB]** [-18...+18]

Sets the gain of Band 1.

**Band2 Fc [Hz]** [50...5.00k]

Sets the center frequency of Band 2.

**Q** [0.5...10.0]

Sets the bandwidth of Band 2.

**Gain [dB]** [-18...+18]

Sets the gain of Band 2.

**Band3 Fc [Hz]** [300...10.00k]

Sets the center frequency of Band 3.

**Q** [0.5...10.0]

Sets the bandwidth of Band 3.

**Gain [dB]** [-18...+18]

Sets the gain of Band 3.

**Band4 Fc [Hz]** [500...20.00k]

Sets the center frequency of Band 4.

**Q** [0.5...10.0]

Sets the bandwidth of Band 4.

**Gain [dB]** [-18...+18]

Sets the gain of Band 4.

### EXCITER

**Emphasis Frequency** [0...70]

Sets the frequency range to be emphasized. For more information, see “Emphasis Frequency” on page 905.

**Exciter Blend** [+/-100]

Sets the intensity (depth) of the Exciter effect. For more information, see “Blend” on page 905.

### MULTITAP DELAY

**Tap1 Time [msec]** [0.0...1360.0]

Sets the Tap1 delay time.

**Tap2 Time [msec]** [0.0...1360.0]

Sets the Tap2 delay time.

**Tap1 Level** [0...100]

Sets the Tap1 output level. For more information, see “Tap1 Level” on page 964.

**Feedback (Tap2)** [+/-100]

Sets the Tap2 feedback amount.

**High Damp [%]** [0...100]

Sets the amount of high-frequency attenuation.

**Wet/Dry ** [Dry, 1:99...99:1, Wet]

Sets the multitap delay effect balance. For more information, see “Pan” on page 955.

**Source** [Off...Tempo]

Selects the Wet/Dry modulation source for the multitap delay.

**Amount** [+/-100]

Sets the Wet/Dry modulation amount for the multitap delay.

### COMPRESSOR

For details on the Compressor graphics, see “001: Stereo Dyna Compressor” on page 889.

**Sensitivity** [1...100]

Sets the sensitivity. For more information, see “Sensitivity” on page 889.

**Attack** [1...100]

Sets the attack level. For more information, see “Attack” on page 890.

**Output Level** [0...100]

Sets the compressor output level. For more information, see “OUTPUT” on page 890.

### LIMITER

For details on the Limiter graphics, see “005: Stereo Limiter” on page 896.

**Ratio** [1.0:1...50.0:1, Inf:1]

Sets the signal compression ratio. For more information, see “Ratio” on page 891.

**Threshold [dB]** [-40...0]

Sets the level above which the compressor is applied. For more information, see “Threshold [dB]” on page 892.

**Attack** [1...100]

Sets the attack time. For more information, see “Attack [msec]” on page 892.

**Release** [1...100]

Sets the release time. For more information, see “Release [msec]” on page 892.

**Gain Adjust [dB]** [-Inf, -38...+24]

Sets the limiter output gain. For more information, see “Gain Adjust [dB]” on page 892.

**Pre EQ****Trim** [0...100]

Sets the EQ input level.

**Pre LEQ Gain [dB]** [-15...+15]

Sets the gain of the Low EQ.

**Pre HEQ Gain [dB]** [-15...+15]

Sets the gain of the High EQ

**OD/HI-GAIN****DRIVE**

For more information on these parameters, see “DRIVE” on page 918.

**Drive Mode** [Overdrive, Hi-Gain]

Switches between overdrive and high-gain distortion.

**Drive** [1...100]

Sets the degree of distortion.

**Output Level**  [0...50]

Sets the overdrive output level.

**Source** [Off...Tempo]

Selects the modulation source for the overdrive output level.

**Amount** [-50...+50]

Sets the modulation amount of the overdrive output level.

**EQ****Low Fc [Hz]** [20...1.00k]

Sets the center frequency for low-frequency shelving EQ.

**Gain [dB]** [-18...+18]

Sets the gain of the Low EQ.

**Mid1 Fc [Hz]** [300...10.00k]

Sets the center frequency for Mid/High EQ 1 (peaking type).

**Q** [0.5...10.0]

Sets the band width of Mid/High EQ 1. For more information, see “Q” on page 902.

**Gain [dB]** [-18...+18]

Sets the gain of Mid/High EQ 1.

**Mid2 Fc [Hz]** [500...20.00k]

Sets the center frequency for Mid/High EQ 2 (peaking type).

**Q** [0.5...10.0]

Sets the band width of Mid/High EQ 2. For more information, see “Q” on page 902.

**Gain [dB]** [-18...+18]

Sets the gain of Mid/High EQ 2.

**WAH****CONTROL****Sweep Mode** [Auto, Dmod, LFO]

Selects the control from auto-wah, modulation source, and LFO. See “Sweep Mode” on page 906.

**Source**  [Off...Tempo]

Selects the modulation source for the wah when Sweep Mode=Dmod.

**LFO****Frequency [Hz]** [0.02...20.00]

Sets the LFO speed.

**WAH****Frequency Bottom** [0...100]

Sets the lower limit of the wah center frequency. p.907.

**Frequency Top** [0...100]

Sets the upper limit of the wah center frequency. p.907.

**Resonance** [0...100]

Sets the resonance amount.

**LPF** [Check-box]

Switches the wah low pass filter on and off.

**Wet/Dry**  [Dry, 1:99...99:1, Wet]

Sets the wah effect balance.

**Source** [Off...Tempo]

Selects the Wet/Dry modulation source for the wah.

**Amount** [+/-100]

Sets the Wet/Dry modulation amount for the wah.

**CHORUS/FLANGER**

This effect can produce either chorusing or flanging, depending on the settings.

The default settings create flanging.

To produce a chorus effect instead, change the settings as follows:

- **Frequency [Hz]:** 0.80
- **Delay Time [msec]:** 20.0
- **Depth:** 70
- **Feedback:** +0

**LFO**

**Waveform** [Triangle, Sine]

Selects the LFO Waveform.

**Frequency [Hz]** [0.02...20.00]

Sets the LFO speed.

**FLANGER**

**Delay Time [msec]** [0.0...1350.0]

Sets the delay time.

**Depth** [0...100]

Sets the depth of LFO modulation.

**Feedback** [+/-100]

This controls the intensity of the flanger effect. Positive and negative values create different timbres. To produce a chorus effect instead of flanging, set this to +0.

Mixing the processed and dry signals via **Wet/Dry** will enhance the effect. For maximum intensity, set **Feedback** and **Wet/Dry** so that they are either both positive or both negative; this emphasizes the flanger's harmonic peaks.

**Output Mode** [Normal, Wet Invert]

**Normal** sends the output of the chorus/flanger to both outputs with the same phase.

**Wet Invert** flips the phase of the chorus/flanger's right channel. This creates a pseudo-stereo effect, adding depth to the sound.

However, if a mono-input effect is connected after this effect, the left and right sounds may cancel each other, eliminating the chorus/flanger effect.

Some of the Mono-Mono Serial effects include a **Routing** parameter, which allows you to swap the order of the effects. When the **Routing** is set so that the Chorus/Flanger comes first (such as **Flanger > Comp** or **Flanger > OD/HG**), the will be grayed out; internally, it will act as if set to **Normal**.

**Wet/Dry**  [-Wet...-1:99, Dry, 1: 99...Wet]

Sets the balance between the "wet" processed sound and the dry input. Negative values invert the phase of the wet signal. This interacts with **Feedback**, as described above.

**Note:** 138: Cho/Flanger - Multitap Dly does not include Wet/Dry modulation for the Chorus/Flanger section.

**Source** [Off...Tempo]

Selects the Wet/Dry modulation source for the chorus/flanger.

**Amount** [+/-100]

Sets the Wet/Dry modulation amount for the chorus/flanger.

**PHASER**

**LFO**

**Waveform** [Triangle, Sine]

Selects the LFO Waveform.

**Frequency [Hz]** [0.02...20.00]

Sets the LFO speed.

**PHASER**

**Manual** [0...100]

Sets the phaser's center frequency.

**Depth** [0...100]

Sets the depth of LFO modulation.

**Resonance** [+/-100]

This controls the intensity of the phaser effect. Positive and negative values create different timbres.

Mixing the processed and dry signals via **Wet/Dry** will enhance the effect. For maximum intensity, set **Resonance** and **Wet/Dry** so that they are either both positive or both negative; this emphasizes the phaser's harmonic peaks.

**Output Mode** [Normal, Wet Invert]

Selects whether the phaser output is mono or pseudo-stereo. For more information, see the Chorus/Flanger "Output Mode," above.

**Wet/Dry**  [-Wet...-1:99, Dry, 1: 99...Wet]

Sets the balance between the "wet" processed sound and the dry input. Negative values invert the phase of the wet signal. This interacts with **Resonance**, as described above.

**Note:** 139: Phaser - Chorus/Flanger does not include Wet/Dry modulation for the Phaser section.

**Source** [Off...Tempo]

Selects the Wet/Dry modulation source for the phaser.

**Amount** [+/-100]

Sets the Wet/Dry modulation amount for the phaser.

## 109: P4EQ - Exciter

This effect combines a mono four-band parametric equalizer and an exciter.

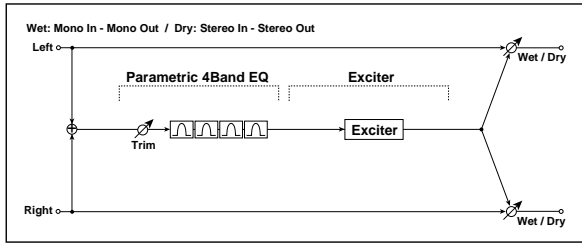

### PARAMETRIC EQ

This is a 4-band parametric EQ. For detailed information, see "PARAMETRIC EQ" on page 988.

### EXCITER

For detailed information on the effects parameters, see "EXCITER" on page 988.

### OUTPUT

This is the standard effects output section, with modulatable control over wet/dry balance. For more information, see "OUTPUT" on page 890.

## 110: P4EQ - Wah

This effect combines a mono four-band parametric equalizer and a wah. You can change the order of the connection.

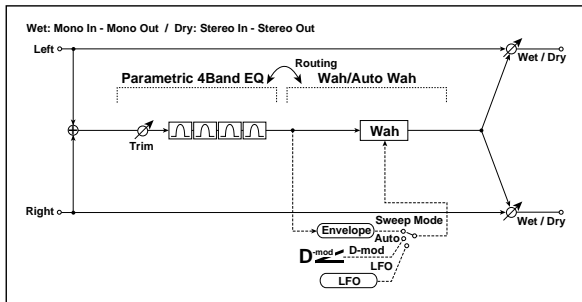

### PARAMETRIC EQ

This is a 4-band parametric EQ. For detailed information, see "PARAMETRIC EQ" on page 988.

### WAH

For detailed information, see "WAH" on page 989.

### OUTPUT

This is the standard effects output section, with modulatable control over wet/dry balance. For more information, see "OUTPUT" on page 890.

### Routing

**Routing [P4EQ > Wah, Wah > P4EQ]**

Changes the order of the parametric equalizer and wah connection.

## 111: P4EQ - Chorus/Flanger

This effect combines a mono four-band parametric equalizer and a chorus/flanger.

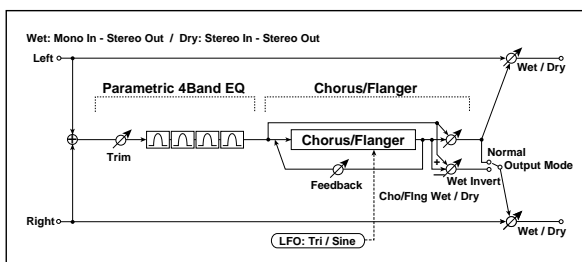

### CHORUS/FLANGER

This effect can produce either chorusing or flanging, depending on the settings. For detailed information, see "CHORUS/FLANGER" on page 989.

### OUTPUT

This is the standard effects output section, with modulatable control over wet/dry balance. For more information, see "OUTPUT" on page 890.

### PARAMETRIC EQ

This is a 4-band parametric EQ. For detailed information, see "PARAMETRIC EQ" on page 988.



## 112: P4EQ - Phaser

This effect combines a mono four-band parametric equalizer and a phaser.

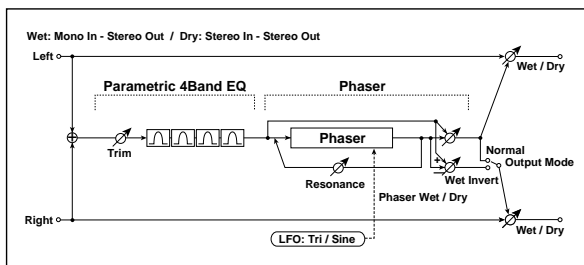

### PARAMETRIC EQ

This is a 4-band parametric EQ. For detailed information, see "PARAMETRIC EQ" on page 988.

### PHASER

This is a mono phaser effect. For detailed information, see "PHASER" on page 990.

### OUTPUT

This is the standard effects output section, with modulatable control over wet/dry balance. For more information, see "OUTPUT" on page 890.

## 113: P4EQ - Multitap Delay

This effect combines a mono four-band parametric equalizer and a multitap delay.

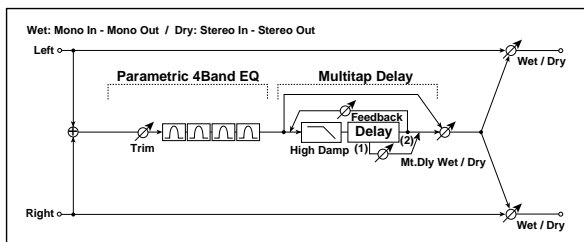

### PARAMETRIC EQ

This is a 4-band parametric EQ. For detailed information, see "PARAMETRIC EQ" on page 988.

### MULTITAP DELAY

This is a 2-tap delay. For detailed information, see "MULTITAP DELAY" on page 988.

### OUTPUT

This is the standard effects output section, with modulatable control over wet/dry balance. For more information, see "OUTPUT" on page 890.

## 114: Comp - Wah

This effect combines a mono compressor and a wah. You can change the order of the connection.

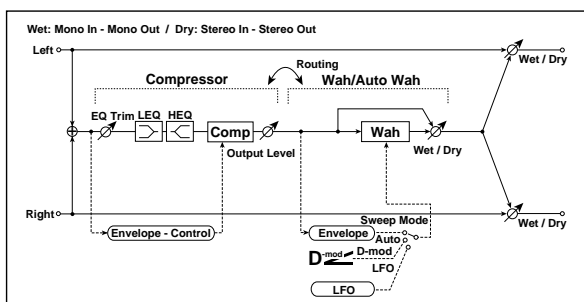

### COMPRESSOR

For detailed information, see "COMPRESSOR" on page 988.

### WAH

For detailed information, see "WAH" on page 989.

### OUTPUT

This is the standard effects output section, with modulatable control over wet/dry balance. For more information, see "OUTPUT" on page 890.

### Routing

**Routing [Comp > Wah, Wah > Comp]**

Switches the order of the compressor and wah.

### COMPRESSOR

#### Pre EQ

For detailed information, see "Pre EQ" on page 989.

## 115: Comp - Amp Sim

This effect combines a mono compressor and an amp simulation. You can change the order of the effects.

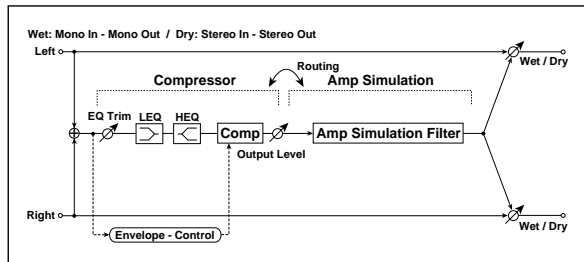

### Routing

**Routing** [Comp > Amp, Amp > Comp]

Switches the order of the compressor and amp simulation.

### COMPRESSOR

#### Pre EQ

For detailed information, see “Pre EQ” on page 989.

#### COMPRESSOR

For detailed information, see “COMPRESSOR” on page 988.

### AMP SIM

**Amplifier Type** [SS, EL84, 6L6]

Selects the type of guitar amplifier.

### OUTPUT

This is the standard effects output section, with modulatable control over wet/dry balance. For more information, see “OUTPUT” on page 890.

## 116: Comp - OD/HiGain

This effect combines a mono compressor and an overdrive/high-gain distortion. You can change the order of the effects.

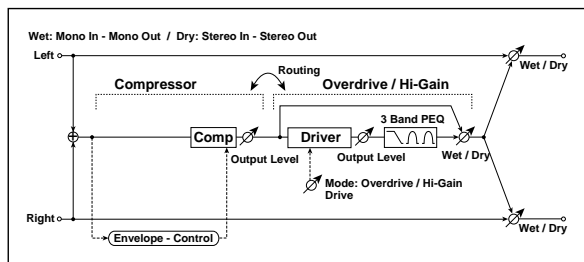

### Routing

**Routing** [Comp > OD/HG, OD/HG > Comp]

Switches the order of the compressor and overdrive.

### COMPRESSOR

For detailed information, see “COMPRESSOR” on page 988.

### OD/HI-GAIN

For detailed information, see “OD/HI-GAIN” on page 989.

### OUTPUT

This is the standard effects output section, with modulatable control over wet/dry balance. For more information, see “OUTPUT” on page 890.

## 117: Comp - P4EQ

This effect combines a mono compressor and a four-band parametric equalizer. You can change the order of the effects.

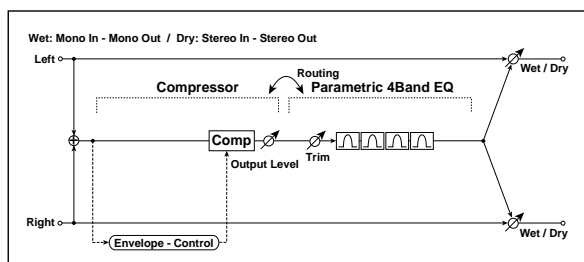

### Routing

**Routing** [Comp > P4EQ, P4EQ > Comp]

Switches the order of the compressor and parametric EQ.

### COMPRESSOR

For detailed information, see “COMPRESSOR” on page 988.

### PARAMETRIC EQ

This is a 4-band parametric EQ. For detailed information, see “PARAMETRIC EQ” on page 988.

## OUTPUT

This is the standard effects output section, with modulatable control over wet/dry balance. For more information, see “OUTPUT” on page 890.

## 118: Comp - Chorus/Flanger

This effect combines a mono compressor and a chorus/flanger. You can change the order of the effects.

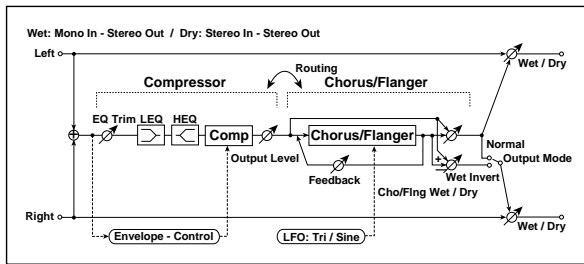

### Routing

**Routing [Comp > Flanger, Flanger > Comp]**

Switches the order of the compressor and chorus/flanger.

When **Routing** is set to **Flanger > Comp**, the Chorus/Flanger’s **Output Mode** will be grayed out and internally set to **Normal**.

### COMPRESSOR

#### Pre EQ

For detailed information, see “Pre EQ” on page 989.

#### COMPRESSOR

For detailed information, see “COMPRESSOR” on page 988.

### CHORUS/FLANGER

This effect can produce either chorusing or flanging, depending on the settings. For detailed information, see “CHORUS/FLANGER” on page 989.

### OUTPUT

This is the standard effects output section, with modulatable control over wet/dry balance. For more information, see “OUTPUT” on page 890.

## 119: Comp - Phaser

This effect combines a mono compressor and a phaser. You can change the order of the effects.

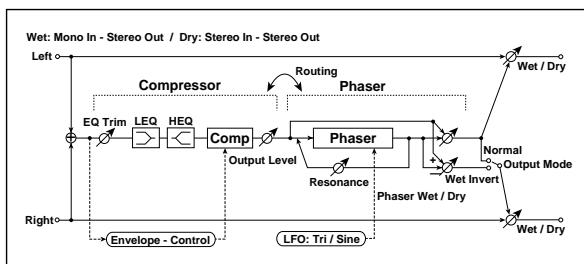

### Routing

**Routing [Comp > Phaser, Phaser > Comp]**

Switches the order of the compressor and phaser.

When **Routing** is set to **Phaser > Comp**, the Phaser’s **Output Mode** will be grayed out and internally set to **Normal**.

### COMPRESSOR

For detailed information, see “COMPRESSOR” on page 988.

### PHASER

#### Pre EQ

For detailed information, see “Pre EQ” on page 989.

### LFO and PHASER

This is a mono phaser effect. For detailed information, see “PHASER” on page 990.

### OUTPUT

This is the standard effects output section, with modulatable control over wet/dry balance. For more information, see “OUTPUT” on page 890.

## 120: Comp - Multitap Delay

This effect combines a mono compressor and a multitap delay. You can change the order of the effects.

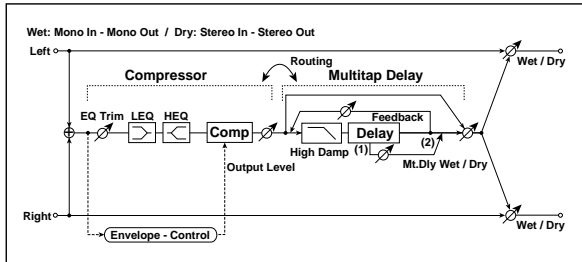

### Routing

**Routing [Comp > Mt.Delay, Mt.Delay > Comp]**

Switches the order of the compressor and multitap delay.

### Pre EQ

For detailed information, see “Pre EQ” on page 989.

### COMPRESSOR

For detailed information, see “COMPRESSOR” on page 988.

### MULTITAP DELAY

This is a 2-tap delay. For detailed information, see “MULTITAP DELAY” on page 988.

### OUTPUT

This is the standard effects output section, with modulatable control over wet/dry balance. For more information, see “OUTPUT” on page 890.

## 121: Limiter - P4EQ

This effect combines a mono limiter and a four-band parametric equalizer. You can change the order of the effects.

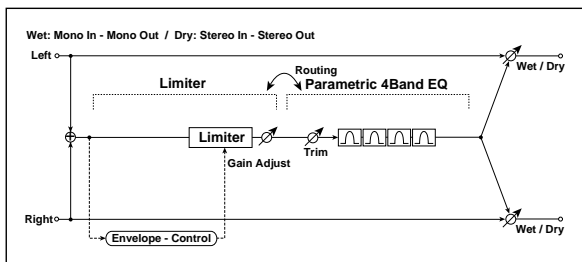

### Routing

**Routing [Limiter > P4EQ, P4EQ > Limiter]**

Switches the order of the limiter and parametric EQ.

### LIMITER

For detailed information, see “LIMITER” on page 988.

### PARAMETRIC EQ

This is a 4-band parametric EQ. For detailed information, see “PARAMETRIC EQ” on page 988.

### OUTPUT

This is the standard effects output section, with modulatable control over wet/dry balance. For more information, see “OUTPUT” on page 890.

## 122: Limiter - Chorus/Flanger

This effect combines a mono limiter and a chorus/flanger. You can change the order of the effects.

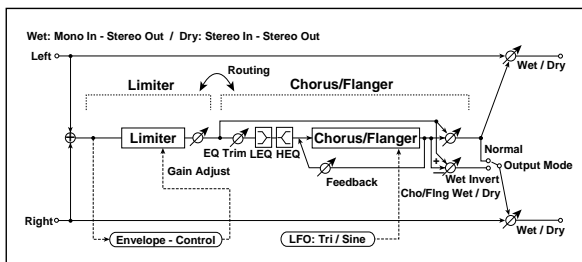

### Routing

**Routing [Limiter > Flanger, Flanger > Limiter]**

Switches the order of the limiter and chorus/flanger.

When **Routing** is set to **Flanger > Limiter**, the Chorus/Flanger’s **Output Mode** will be grayed out and internally set to **Normal**.

### LIMITER

For detailed information, see “LIMITER” on page 988.

## CHORUS/FLANGER

### Pre EQ

For detailed information, see “Pre EQ” on page 989.

### LFO and FLANGER

This effect can produce either chorusing or flanging, depending on the settings. For detailed information, see “CHORUS/FLANGER” on page 989.

## 123: Limiter - Phaser

This effect combines a mono limiter and a phaser. You can change the order of the effects.

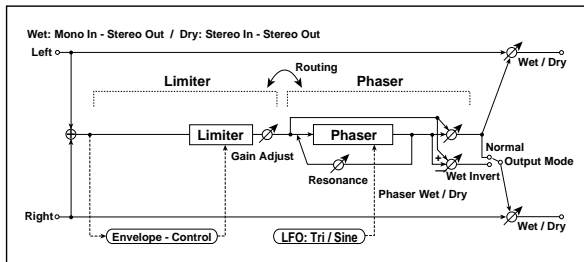

### Routing

**Routing [Limiter > Phaser, Phaser > Limiter]**

Switches the order of the limiter and phaser.

## 124: Limiter - Multitap Delay

This effect combines a mono limiter and a multitap delay. You can change the order of the effect s.

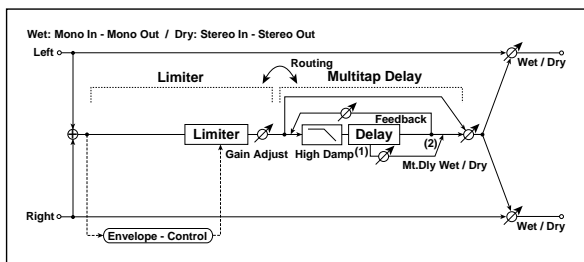

### Routing

**Routing [Limiter > Mt.Delay, Mt.Delay > Limiter]**

Switches the order of the limiter and multitap delay.

### LIMITER

For detailed information, see “LIMITER” on page 988.

### MULTITAP DELAY

This is a 2-tap delay. For detailed information, see “MULTITAP DELAY” on page 988.

### OUTPUT

This is the standard effects output section, with modulatable control over wet/dry balance. For more information, see “OUTPUT” on page 890.

When **Routing** is set to **Phaser > Limiter**, the Phaser’s **Output Mode** will be grayed out and internally set to **Normal**.

### LIMITER

For detailed information, see “LIMITER” on page 988.

### PHASER

This is a mono phaser effect. For detailed information, see “PHASER” on page 990.

### OUTPUT

This is the standard effects output section, with modulatable control over wet/dry balance. For more information, see “OUTPUT” on page 890.

### OUTPUT

This is the standard effects output section, with modulatable control over wet/dry balance. For more information, see “OUTPUT” on page 890.

## 125: Exciter - Comp

This effect combines a mono exciter and a compressor. You can change the order of the effects.

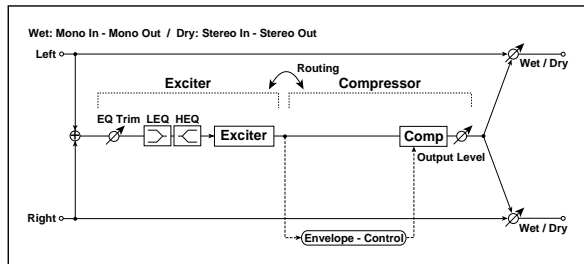

### Routing

**Routing** [Exciter > Comp, Comp > Exciter]

Switches the order of the exciter and compressor.

## 126: Exciter - Limiter

This effect combines a mono exciter and a limiter. You can change the order of the effects.

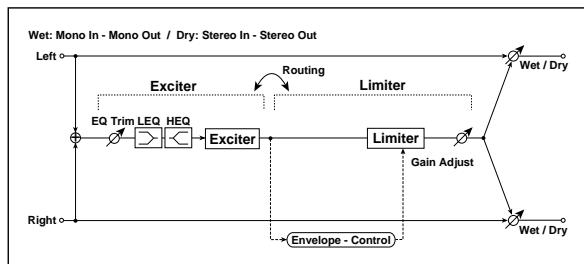

### Routing

**Routing** [Exciter > Limiter, Limiter > Exciter]

Switches the order of the exciter and limiter.

## 127: Exciter - Chorus/Flanger

This effect combines a mono limiter and a chorus/flanger.

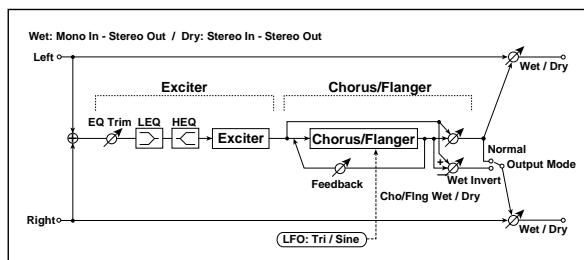

### EXCITER

#### Pre EQ

For detailed information, see "Pre EQ" on page 989.

### EXCITER

#### Pre EQ

For detailed information, see "Pre EQ" on page 989.

#### EXCITER

For detailed information, see "EXCITER" on page 988.

### COMPRESSOR

For detailed information, see "COMPRESSOR" on page 988.

### OUTPUT

This is the standard effects output section, with modulatable control over wet/dry balance. For more information, see "OUTPUT" on page 890.

### EXCITER

#### Pre EQ

For detailed information, see "Pre EQ" on page 989.

#### EXCITER

For detailed information, see "EXCITER" on page 988.

### LIMITER

For detailed information, see "LIMITER" on page 988.

### OUTPUT

This is the standard effects output section, with modulatable control over wet/dry balance. For more information, see "OUTPUT" on page 890.

### EXCITER

For detailed information, see "EXCITER" on page 988.

### CHORUS/FLANGER

This effect can produce either chorusing or flanging, depending on the settings. For detailed information, see "CHORUS/FLANGER" on page 989.

### OUTPUT

This is the standard effects output section, with modulatable control over wet/dry balance. For more information, see "OUTPUT" on page 890.

## 128: Exciter - Phaser

This effect combines a mono limiter and a phaser.

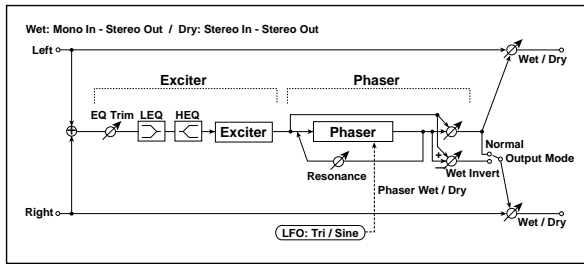

### EXCITER

#### Pre EQ

For detailed information, see “Pre EQ” on page 989.

### EXCITER

For detailed information, see “EXCITER” on page 988.

### PHASER

This is a mono phaser effect. For detailed information, see “PHASER” on page 990.

### OUTPUT

This is the standard effects output section, with modulatable control over wet/dry balance. For more information, see “OUTPUT” on page 890.

## 129: Exciter - Multitap Delay

This effect combines a mono exciter and a multitap delay.

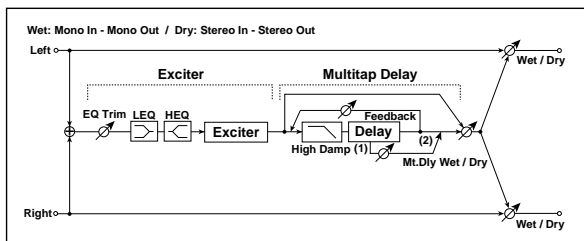

### EXCITER

#### Pre EQ

For detailed information, see “Pre EQ” on page 989.

### EXCITER

For detailed information, see “EXCITER” on page 988.

### MULTITAP DELAY

This is a 2-tap delay. For detailed information, see “MULTITAP DELAY” on page 988.

### OUTPUT

This is the standard effects output section, with modulatable control over wet/dry balance. For more information, see “OUTPUT” on page 890.

## 130: OD/Hi Gain - Amp Sim

This effect combines a mono overdrive/high-gain distortion and an amp simulation. You can change the order of the effects.

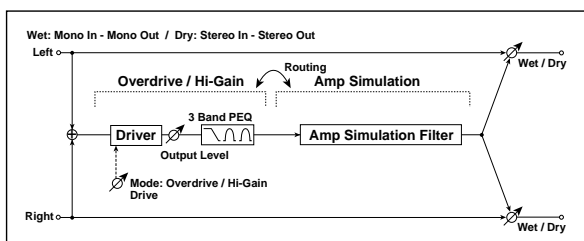

### Routing

**Routing** [OD/HG > Amp, Amp > OD/HG]

Switches the order of the overdrive and amp.

### OD/HI-GAIN

For detailed information, see “OD/HI-GAIN” on page 989.

### AMP SIM

**Amplifier Type** [SS, EL84, 6L6]

Selects the type of guitar amplifier.

### OUTPUT

This is the standard effects output section, with modulatable control over wet/dry balance. For more information, see “OUTPUT” on page 890.



## 131: OD/Hi Gain - Cho/Flanger

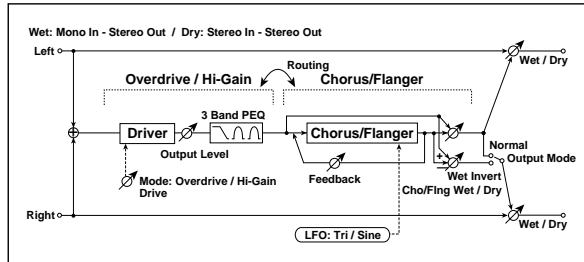

This effect combines a mono overdrive/high-gain distortion and a chorus/flanger. You can change the order of the effects.

### Routing

**Routing** [OD/HG > Flanger, Flanger > OD/HG]

Switches the order of the overdrive and chorus / flanger.

When **Routing** is set to **Flanger > OD/HG**, the Chorus/Flanger's **Output Mode** will be grayed out and internally set to **Normal**.

### OD/HI-GAIN

For detailed information, see "OD/HI-GAIN" on page 989.

### CHORUS/FLANGER

This effect can produce either chorusing or flanging, depending on the settings. For detailed information, see "CHORUS/FLANGER" on page 989.

### OUTPUT

This is the standard effects output section, with modulatable control over wet/dry balance. For more information, see "OUTPUT" on page 890.

## 132: OD/Hi Gain - Phaser

This effect combines a mono overdrive/high-gain distortion and a phaser. You can change the order of the effects.

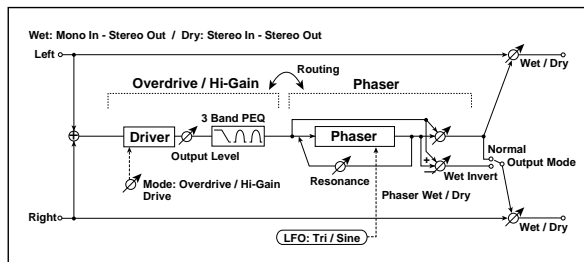

### Routing

**Routing** [OD/HG > Phaser, Phaser > OD/HG]

Switches the order of the overdrive and phaser.

When **Routing** is set to **Phaser > OD/HG**, the Phaser's will be grayed out and internally set to **Normal**.

### OD/HI-GAIN

For detailed information, see "OD/HI-GAIN" on page 989.

### PHASER

This is a mono phaser effect. For detailed information, see "PHASER" on page 990.

### OUTPUT

This is the standard effects output section, with modulatable control over wet/dry balance. For more information, see "OUTPUT" on page 890.

## 133: OD/Hi Gain - Multitap Dly

This effect combines a mono overdrive/high-gain distortion and a multitap delay.

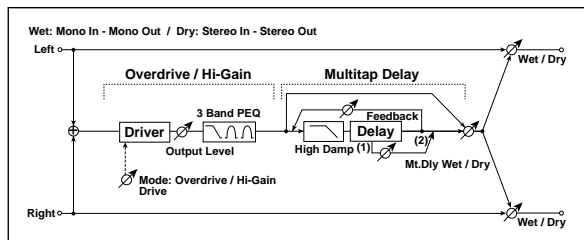

### OD/HI-GAIN

For detailed information, see "OD/HI-GAIN" on page 989.

### MULTITAP DELAY

For detailed information, see "MULTITAP DELAY" on page 988.

### OUTPUT

This is the standard effects output section, with modulatable control over wet/dry balance. For more information, see "OUTPUT" on page 890.

## 134: Wah - Amp Sim

This effect combines a mono wah and an amp simulation. You can change the order of the effects.

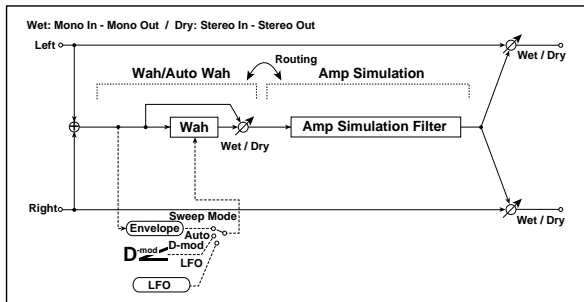

### Routing

**Routing** [Wah > Amp, Amp > Wah]

Switches the order of the wah and amp simulation.

## 135: Decimator - Amp Sim

This effect combines a mono decimator and an amp simulation. You can change the order of the effects.

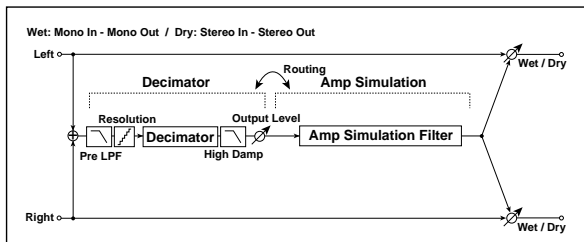

### Routing

**Routing** [Decimator > Amp, Amp > Decimator]

Switches the order of the decimator and amp simulation.

### DECIMATOR

**Pre LPF** [Check-box]

Turn the harmonic noise caused by lowered sampling on and off. See "Pre LPF" on page 913.

**Sampling Frequency [Hz]** [1.00k...48.00k]

Sets the sampling frequency.

## 136: Decimator - Comp

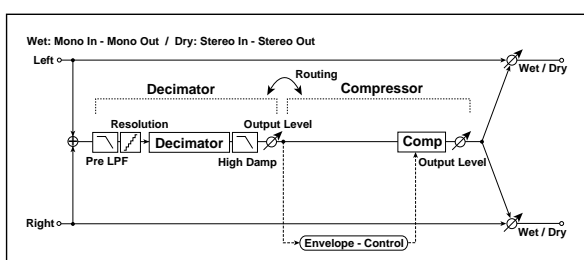

### WAH

For detailed information, see "WAH" on page 989.

### AMP SIM

**Amplifier Type** [SS, EL84, 6L6]

Selects the type of guitar amplifier.

### OUTPUT

This is the standard effects output section, with modulatable control over wet/dry balance. For more information, see "OUTPUT" on page 890.

**High Damp [%]** [0...100]

Sets the amount of high-frequency attenuation.

### BIT SHAPE

For more information on these parameters, see "Resolution [bits]" on page 913.

**Resolution [bits]** [4...24]

Sets the data bit length.

**Output Level** [0...100]

Sets the decimator output level.

### AMP SIM

**Amplifier Type** [SS, EL84, 6L6]

Selects the type of guitar amplifier.

### OUTPUT

This is the standard effects output section, with modulatable control over wet/dry balance. For more information, see "OUTPUT" on page 890.

This effect combines a mono decimator and a compressor. You can change the order of the effects.

### Routing

**Routing** [Decimator > Comp, Comp > Decimator]

Switches the order of the decimator and compressor.

## DECIMATOR

**Pre LPF** [Check-box]

Enables and disables a filter which prevents aliasing noise. See "Pre LPF" on page 913.

**Sampling Frequency [Hz]** [1.00k...48.00k]

Sets the sampling frequency.

**High Damp [%]** [0...100]

Sets the amount of high-frequency attenuation.

## BIT SHAPE

For more information on these parameters, see "Resolution [bits]" on page 913.

**Resolution [bits]** [4...24]

Sets the data bit length.

**Output Level** [0...100]

Sets the decimator output level.

## COMPRESSOR

For detailed information, see "COMPRESSOR" on page 988.

## OUTPUT

This is the standard effects output section, with modulatable control over wet/dry balance. For more information, see "OUTPUT" on page 890.

# 137: Amp Sim - Tremolo

This effect combines a mono amp simulation and a tremolo.

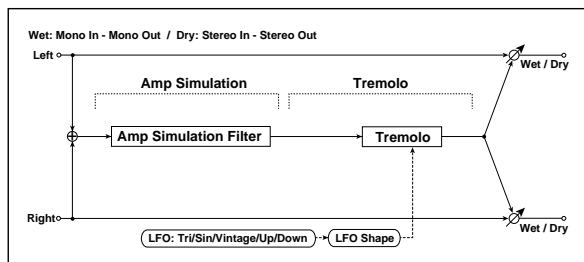

## AMP SIM

**Amplifier Type** [SS, EL84, 6L6]

Selects the type of guitar amplifier.

## TREMOLO

### LFO

**Waveform** [Triangle, Sine, Vintage, Up, Down]

Selects the LFO Waveform. See "Waveform" on page 945.

**Shape** [+/-100]

Changes the curvature of the LFO Waveform. See "Shape" on page 910.

**Frequency [Hz]** [0.02...20.00]

Sets the LFO speed.

### TREMOLO

**Depth** [0...100]

Sets the depth of LFO modulation.

## OUTPUT

This is the standard effects output section, with modulatable control over wet/dry balance. For more information, see "OUTPUT" on page 890.

## 138: Cho/Flanger - Multitap Dly

This effect combines a mono chorus/flanger and a multitap delay.

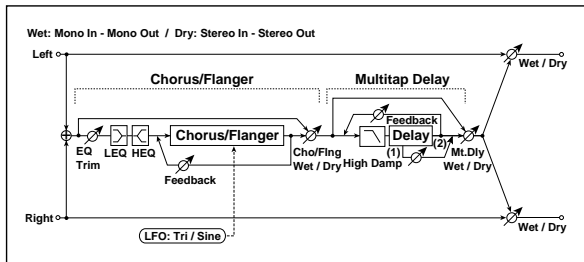

### CHORUS/FLANGER

#### Pre EQ

For detailed information, see “Pre EQ” on page 989.

### LFO and FLANGER

This effect can produce either chorusing or flanging, depending on the settings. For detailed information, see “CHORUS/FLANGER” on page 989.

**Note:** Unlike the other Mono-Mono Serial effects, this Chorus/Flanger does not include modulation of Wet/Dry.

### MULTITAP DELAY

For detailed information, see “MULTITAP DELAY” on page 988.

### OUTPUT

This is the standard effects output section, with modulatable control over wet/dry balance. For more information, see “OUTPUT” on page 890.

## 139: Phaser - Chorus/Flanger

This effect combines a mono phaser and a chorus/flanger.

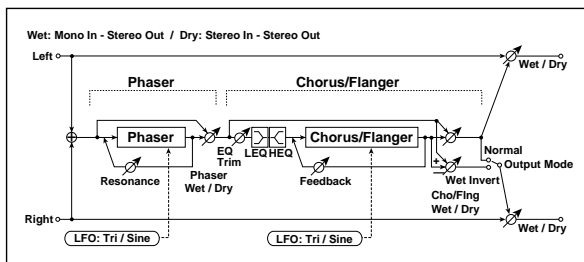

### PHASER

This is a mono phaser effect. For detailed information, see “PHASER” on page 990.

### CHORUS/FLANGER

#### Pre EQ

For detailed information, see “Pre EQ” on page 989.

### LFO and FLANGER

This effect can produce either chorusing or flanging, depending on the settings. For detailed information, see “CHORUS/FLANGER” on page 989.

### OUTPUT

This is the standard effects output section, with modulatable control over wet/dry balance. For more information, see “OUTPUT” on page 890.

## 140: Reverb - Gate

This effect combines a mono reverb and a gate.

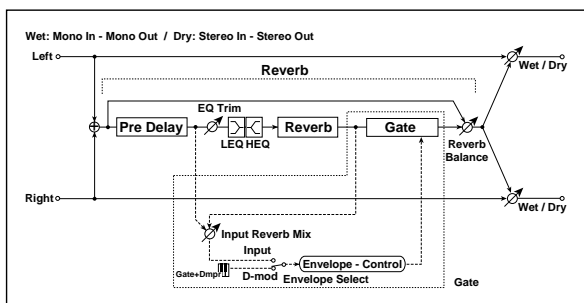

### REVERB

#### Pre EQ

#### Trim

Sets the EQ input level.

[0...100]

#### LEQ Fc

[Low, Mid-Low]

Selects the cutoff frequency (low or mid-low) of the low-range equalizer.

#### LEQ Gain [dB]

[-15.0...+15.0]

Sets the gain of the Low EQ.

#### HEQ Fc

[High, Mid-High]

Selects the cutoff frequency (high or mid-high) of the high-range equalizer.

#### HEQ Gain [dB]

[-15.0...+15.0]

Sets the gain of the High EQ.

### REVERB

#### Pre Delay [msec]

[0...200]

Sets the delay time of the reverb sound and gate control signal.

**High Damp [%] [0...100]**

Sets the amount of high-frequency attenuation.

**Reverb Time [sec] [0.1...10.0]**

Sets the reverberation time.

**Wet/Dry [Dry, 1:99...99:1, Wet]**

Sets the reverb effect balance.

**GATE**

For details on the Gate graphics, see “009: Stereo Gate” on page 900.

**CONTROL****Envelope Select [Dmod, Input]**

This chooses whether the gate is triggered by the signal level, or controlled directly by the selected Dmod Source.

When **Envelope Select** is set to **Input**, the gate is controlled by a blend of the dry audio input and the reverb output, as set by the **Input Reverb Mix**.

**Source  [Off...Tempo]**

Selects the modulation source that controls the gate when **Envelope Select** is set to **Dmod**.

**Input Reverb Mix [Dry, 1:99...99:1, Wet]**

This mixes the dry input and reverb output signals, for controlling the gate.

Normally, set **Input Reverb Mix** to **Dry**, so that the gate is controlled only by the dry input. If you wish to extend the gate time, increase the **Input Reverb Mix** value to include some of the wet mix as well, and adjust the **Threshold**.

**GATE****Threshold [0...100]**

Sets the gate threshold level. When the signal level exceeds the threshold, the gate opens and the reverb sound is heard.

Note that this applies only when **Envelope Select** is set to **Input**. When the gate is controlled via Dmod, it opens when the Dmod value is 64 or higher, and closes when the value is 63 or lower.

**Attack [1...100]**

Sets the attack time. See “Attack” on page 900.

**Release [1...100]**

Sets the release time. See “Release” on page 900.

**Polarity [+,-]**

This lets you invert the gate on/off state. See “Polarity” on page 901.

**OUTPUT**

This is the standard effects output section, with modulatable control over wet/dry balance. For more information, see “OUTPUT” on page 890.

## Mono/Mono Parallel

141: P4EQ // P4EQ through 185: Mt.BPM Dly//Mt.BPM Dly are parallel effects, with the left input going through one effect, and the right going through the other. These provide various combinations of 4-band EQ, Compressor, Limiter, Exciter, Overdrive, Wah, Chorus/Flanger, Phaser, and Multitap Delay, as described below.

### 4 band EQ

For a description of the on-screen EQ graphic, see “011: Stereo Parametric 4EQ” on page 902.

#### PARAMETRIC EQ

**Trim** [0...100]

Sets the input level.

**Band1 Fc [Hz]** [20...1.00k]

Sets the center frequency of Band 1.

**Q** [0.5...10.0]

Sets the bandwidth of Band 1. See “Q” on page 902.

**Gain [dB]** [-18.0...+18.0]

Sets the gain of Band 1.

**Band2 Fc [Hz]** [50...5.00k]

Sets the center frequency of Band 2.

**Q** [0.5...10.0]

Sets the bandwidth of Band 2. See “Q” on page 902.

**Gain [dB]** [-18.0...+18.0]

Sets the gain of Band 2.

**Band3 Fc [Hz]** [300...10.00k]

Sets the center frequency of Band 3.

**Q** [0.5...10.0]

Sets the bandwidth of Band3. See “Q” on page 902.

**Gain [dB]** [-18.0...+18.0]

Sets the gain of Band 3.

**Band4 Fc [Hz]** [500...20.00k]

Sets the center frequency of Band 4.

**Q** [0.5...10.0]

Sets the bandwidth of Band 4. See “Q” on page 902.

**Gain [dB]** [-18.0...+18.0]

Sets the gain of Band 4.

#### OUTPUT

**Pan** [L000...C064...R127]

Sets the stereo image.

**Wet/Dry**  [Dry, 1:99...99:1, Wet]

Sets the balance between the effect and the dry input.

**Source** [Off...Tempo]

Selects a modulation source for Wet/Dry.

**Amount** [+/-100]

Sets the modulation amount for Wet/Dry.

### Compressor

For details on the Compressor graphics, see “001: Stereo Dyna Compressor” on page 889.

#### Pre EQ

**Trim** [0...100]

Sets the EQ input level.

**LEQ Gain [dB]** [-15...+15]

Sets the gain of the Low EQ.

**HEQ Gain [dB]** [-15...+15]

Sets the gain of the High EQ.

#### COMPRESSOR

**Sensitivity** [1...100]

Sets the sensitivity. See “Sensitivity” on page 889.

**Attack** [1...100]

Sets the attack level. See “Attack” on page 890.

**Output Level** [0...100]

Sets the output level.

#### OUTPUT

**Pan** [L000...C064...R127]

Sets the stereo image.

**Wet/Dry**  [Dry, 1:99...99:1, Wet]

Sets the balance between the effect and the dry input.

**Source** [Off...Tempo]

Selects a modulation source for Wet/Dry.

**Amount** [+/-100]

Sets the modulation amount for Wet/Dry.

### Limiter

For details on the Limiter graphics, see “005: Stereo Limiter” on page 896.

#### LIMITER

**Ratio** [1.0:1...50.0:1, Inf:1]

Sets the signal compression ratio. See “Ratio” on page 891.

**Threshold [dB]** [-40...0]

Sets the level above which the compressor is applied. See “Threshold [dB]” on page 892.

**Attack** [1...100]

Sets the attack time. See “Attack [msec]” on page 892.

**Release** [1...100]

Sets the release time. See “Release [msec]” on page 892.

**Gain Adjust [dB]** [-Inf, -38...+24]

Sets the output gain. See "Gain Adjust [dB]" on page 892.

### OUTPUT

**Pan** [L000...C064...R127]

Sets the stereo image.

**Wet/Dry**  $D_{mod}$  [Dry, 1:99...99:1, Wet]

Sets the balance between the effect and the dry input.

**Source** [Off...Tempo]

Selects a modulation source for Wet/Dry.

**Amount** [+/-100]

Sets the modulation amount for Wet/Dry.

---

### Exciter

#### Pre EQ

**Trim** [0...100]

Sets the EQ input level.

**LEQ Gain [dB]** [-15...+15]

Sets the gain of the Low EQ.

**HEQ Gain [dB]** [-15...+15]

Sets the gain of the High EQ.

#### EXCITER

**Emphasis Frequency** [0...70]

Sets the frequency range to be emphasized. See "Emphasis Frequency" on page 905.

**Exciter Blend** [+/-100]

Sets the intensity (depth) of the Exciter effect. See "Blend" on page 905.

### OUTPUT

**Pan** [L000...C064...R127]

Sets the stereo image.

**Wet/Dry**  $D_{mod}$  [Dry, 1:99...99:1, Wet]

Sets the balance between the effect and the dry input.

**Source** [Off...Tempo]

Selects a modulation source for Wet/Dry.

**Amount** [+/-100]

Sets the modulation amount for Wet/Dry.

---

### OD/HI-GAIN

#### DRIVE

For more information on these parameters, see "DRIVE" on page 918.

**Drive Mode** [Overdrive, Hi-Gain]

Switches between overdrive and high-gain distortion.

**Drive** [1...100]

Sets the degree of distortion.

**Output Level**  $D_{mod}$  [0...50]

Sets the output level.

**Source** [Off...Tempo]

Selects the modulation source for the output level.

**Amount** [-50...+50]

Sets the modulation amount of the output level.

#### EQ

**Low Fc [Hz]** [20...1.00k]

Sets the center frequency for Low EQ (shelving type).

**Gain [dB]** [-18...+18]

Sets the gain of the Low EQ.

**Mid1 Fc [Hz]** [300...10.00k]

Sets the center frequency for Mid/High EQ 1 (peaking type).

**Q** [0.5...10.0]

Sets the band width of Mid/High EQ 1. See "Q" on page 902.

**Gain [dB]** [-18...+18]

Sets the gain of Mid/High EQ 1.

**Mid2 Fc [Hz]** [500...20.00k]

Sets the center frequency for Mid/High EQ 2 (peaking type).

**Q** [0.5...10.0]

Sets the band width of Mid/High EQ 2. See "Q" on page 902.

**Gain [dB]** [-18...+18]

Sets the gain of Mid/High EQ 2.

### OUTPUT

**Pan** [L000...C064...R127]

Sets the stereo image.

**Wet/Dry**  $D_{mod}$  [Dry, 1:99...99:1, Wet]

Sets the balance between the effect and the dry input.

**Source** [Off...Tempo]

Selects a modulation source for Wet/Dry.

**Amount** [+/-100]

Sets the modulation amount for Wet/Dry.

---

### WAH

#### CONTROL

**Sweep Mode** [Auto, Dmod, LFO]

Selects the control from auto-wah, modulation source, and LFO. See "Sweep Mode" on page 906.



**Source**  [Off...Tempo]

Selects the modulation source for the wah when Sweep Mode=Dmod.

**LFO**

**LFO Frequency [Hz]** [0.02...20.00]

Sets the LFO speed.

**WAH**

**Frequency Bottom** [0...100]

Sets the lower limit of the wah center frequency. See "Frequency Bottom" on page 907.

**Frequency Top** [0...100]

Sets the upper limit of the wah center frequency. See "Frequency Bottom" on page 907.

**Resonance** [+0...+100]

Sets the resonance amount.

**Low Pass Filter** [Check-box]

Switches the wah low pass filter on and off.

**OUTPUT**

**Pan** [L000...C064...R127]

Sets the stereo image.

**Wet/Dry**  [Dry, 1:99...99:1, Wet]

Sets the balance between the effect and the dry input.

**Source** [Off...Tempo]

Selects a modulation source for Wet/Dry.

**Amount** [+/-100]

Sets the modulation amount for Wet/Dry.

---

**Chorus/Flanger**

**Pre EQ**

**Trim** [0...100]

Sets the EQ input level.

**LEQ Gain [dB]** [-15...+15]

Sets the gain of the Low EQ.

**HEQ Gain [dB]** [-15...+15]

Sets the gain of the High EQ.

**LFO**

**Waveform** [Triangle, Sine]

Selects the LFO Waveform.

**Frequency [Hz]** [0.02...20.00]

Sets the LFO speed.

**FLANGER**

**Delay Time [msec]** [0.0...1350.0]

Sets the delay time.

**Depth** [0...100]

Sets the depth of LFO modulation.

**Feedback** [+/-100]

Sets the feedback amount. See "Feedback" on page 934.

**OUTPUT**

**Pan** [L000...C064...R127]

Sets the stereo image.

**Wet/Dry**  [Dry, 1:99...99:1, Wet]

Sets the balance between the effect and the dry input.

**Source** [Off...Tempo]

Selects a modulation source for Wet/Dry.

**Amount** [+/-100]

Sets the modulation amount for Wet/Dry.

---

**Phaser**

**LFO**

**Waveform** [Triangle, Sine]

Selects the LFO Waveform.

**Frequency [Hz]** [0.02...20.00]

Sets the LFO speed.

**PHASER**

**Manual** [0...100]

Sets the frequency to which the effect is applied.

**Depth** [0...100]

Sets the depth of LFO modulation.

**Resonance** [+/-100]

Sets the resonance amount. See "Resonance" on page 936.

**OUTPUT**

**Pan** [L000...C064...R127]

Sets the stereo image.

**Wet/Dry**  [Dry, 1:99...99:1, Wet]

Sets the balance between the effect and the dry input.

**Source** [Off...Tempo]

Selects a modulation source for Wet/Dry.

**Amount** [+/-100]

Sets the modulation amount for Wet/Dry.

---

**Multi-tap BPM Delay**

**MT DELAY**

**BPM**  [MIDI, 40.00...300.00]

MIDI syncs to the system tempo; 40-240 sets the tempo manually for this individual effect. See "BPM" on page 953.

**Time Over? >** [---, OVER!]

Displays an error message when the delay time exceeds the upper limit. See "Time Over? R >" on page 975.

**Tap1 Base Note** [♪... ♪]

Selects the type of notes to specify the delay time for Tap1. See "Base Note" on page 953.

**Times** [x1...x32]

Sets the number of notes to specify the delay time for Tap1. See "Times" on page 953.

**Tap2 Base Note** [♪... ♪]

Selects the type of notes to specify the delay time for Tap2. See "Base Note" on page 953.

**Times** [x1...x32]

Sets the number of notes to specify the delay time for Tap2. See "Times" on page 953.

**Tap1 Level** [0...100]

Sets the Tap1 output level.

**Feedback** [+/-100]

Sets the Tap2 feedback amount.

**High Damp [%]** [0...100]

Sets the amount of high-frequency attenuation. See "High Damp [%]" on page 961.

**OUTPUT**

**Pan** [L000...C064...R127]

Sets the stereo image.

**Wet/Dry** [Dry, 1:99...99:1, Wet]

Sets the balance between the effect and the dry input.

**Source** [Off...Tempo]

Selects a modulation source for Wet/Dry.

**Amount** [+/-100]

Sets the modulation amount for Wet/Dry.

**141: P4EQ // P4EQ**

This effect connects two four-band EQ units in parallel. The pan and effect balance can be adjusted independently for each.

For detailed information on the effects parameters, see "4 band EQ" on page 1004.

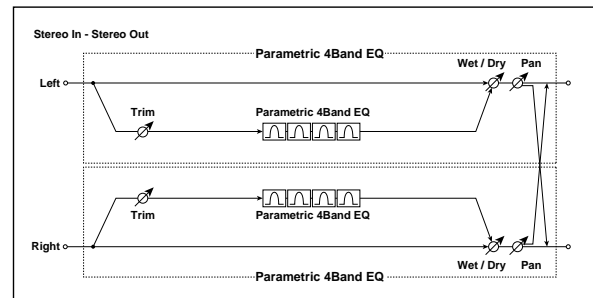

**142: P4EQ // Comp**

This effect connects a four-band EQ and a compressor in parallel. The pan and effect balance can be adjusted independently for each.

For detailed information on the effects parameters, see "4 band EQ" on page 1004 and "Compressor" on page 1004.

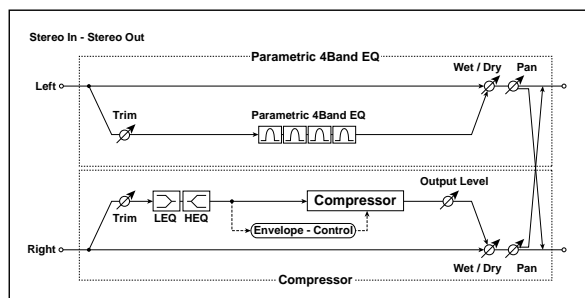

### 143: P4EQ // Limiter

This effect connects a four-band EQ (p.1004) and a limiter (p.1004) in parallel. The pan and effect balance can be adjusted independently for each.

For detailed information on the effects parameters, see “4 band EQ” on page 1004 and “Limiter” on page 1004.

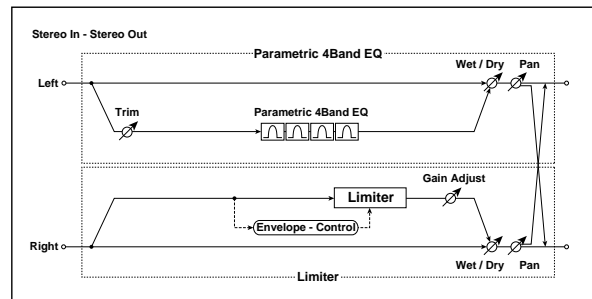

### 144: P4EQ // Exciter

This effect connects a four-band EQ and an exciter in parallel. The pan and effect balance can be adjusted independently for each.

For detailed information on the effects parameters, see “4 band EQ” on page 1004 and “Exciter” on page 1005.

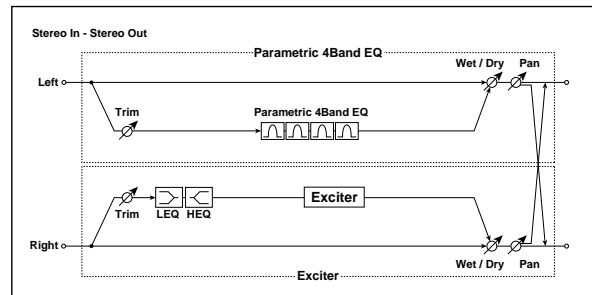

### 145: P4EQ // OD/Hi Gain

This effect connects a four-band EQ and an overdrive in parallel. The pan and effect balance can be adjusted independently for each.

For detailed information on the effects parameters, see “4 band EQ” on page 1004 and “OD/HI-GAIN” on page 1005.

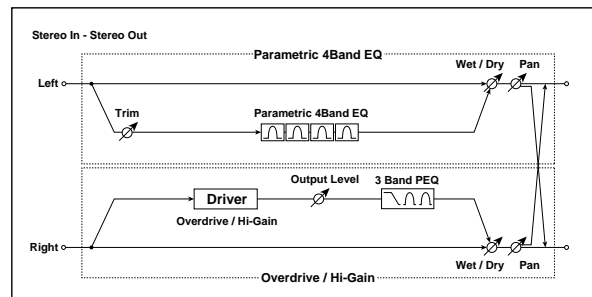

### 146: P4EQ // Wah

This effect connects a four-band EQ and a wah in parallel. The pan and effect balance can be adjusted independently for each.

For detailed information on the effects parameters, see “4 band EQ” on page 1004 and “WAH” on page 1005.

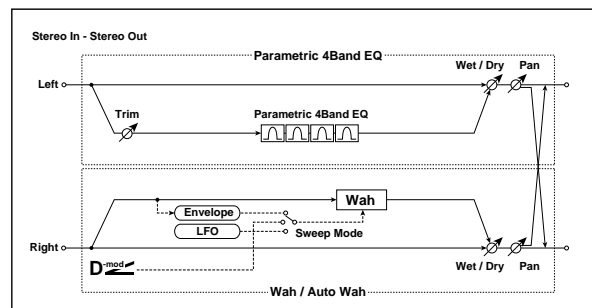

### 147: P4EQ // Chorus/Flanger

This effect connects a four-band EQ and a chorus / flanger in parallel. The pan and effect balance can be adjusted independently for each.

For detailed information on the effects parameters, see "4 band EQ" on page 1004 and "Chorus/Flanger" on page 1006.

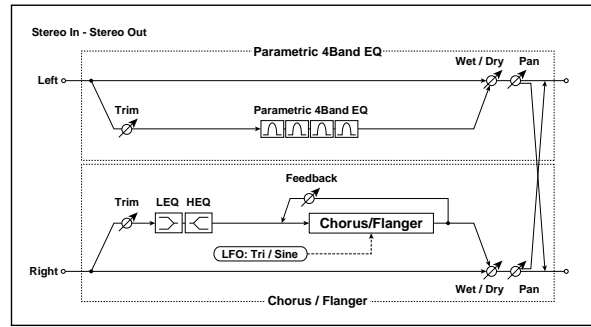

### 148: P4EQ // Phaser

This effect connects a four-band EQ and a phaser in parallel. The pan and effect balance can be adjusted independently for each.

For detailed information on the effects parameters, see "4 band EQ" on page 1004 and "Phaser" on page 1006.

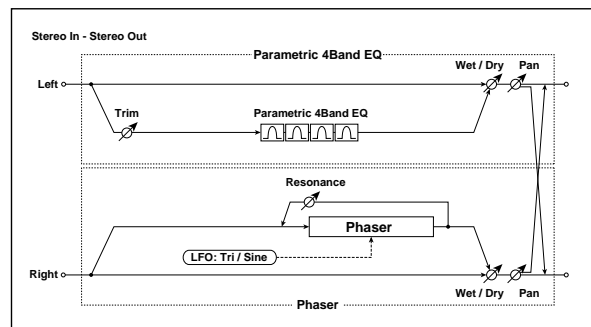

### 149: P4EQ // Multitap BPM Dly

This effect connects a four-band EQ and a multitap BPM delay in parallel. The pan and effect balance can be adjusted independently for each.

For detailed information on the effects parameters, see "4 band EQ" on page 1004 and "Multi-tap BPM Delay" on page 1006.

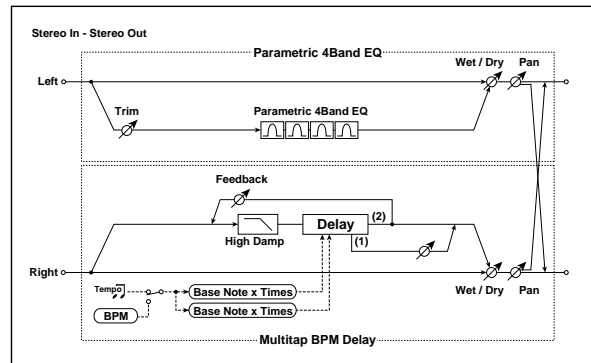

### 150: Comp // Comp

This effect connects two compressors in parallel. The pan and effect balance can be adjusted independently for each.

For detailed information on the effects parameters, see "Compressor" on page 1004.

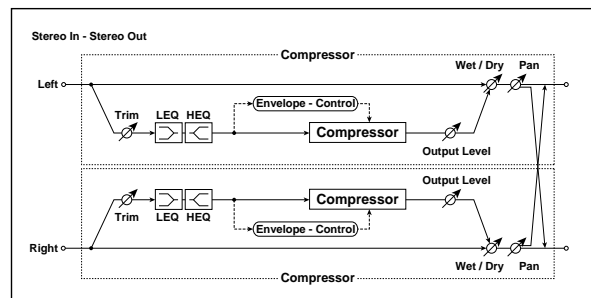

## 151: Comp // Limiter

This effect connects a compressor and a limiter in parallel. The pan and effect balance can be adjusted independently for each.

For detailed information on the effects parameters, see “Compressor” on page 1004 and “Limiter” on page 1004.

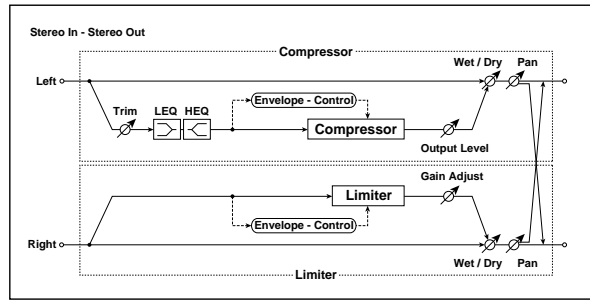

## 152: Comp // Exciter

This effect connects a compressor and an exciter in parallel. The pan and effect balance can be adjusted independently for each.

For detailed information on the effects parameters, see “Compressor” on page 1004 and “Exciter” on page 1005.

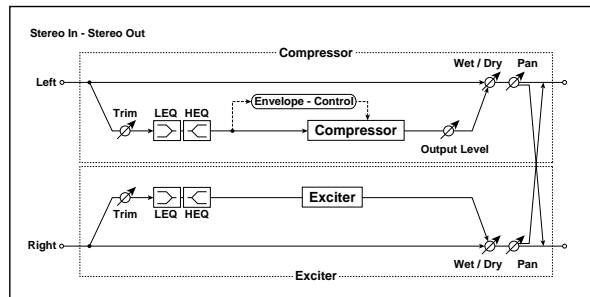

## 153: Comp // OD/Hi Gain

This effect connects a compressor and an overdrive in parallel. The pan and effect balance can be adjusted independently for each.

For detailed information on the effects parameters, see “Compressor” on page 1004 and “OD/HI-GAIN” on page 1005.

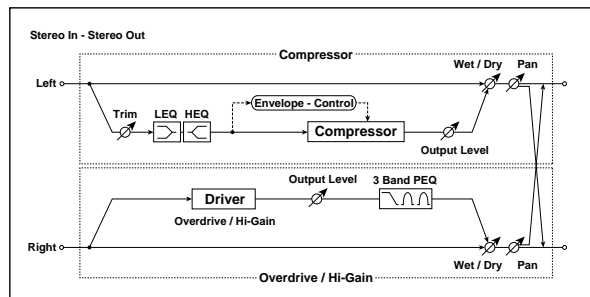

## 154: Comp // Wah

This effect connects a compressor and a wah in parallel. The pan and effect balance can be adjusted independently for each.

For detailed information on the effects parameters, see “Compressor” on page 1004 and “WAH” on page 1005.

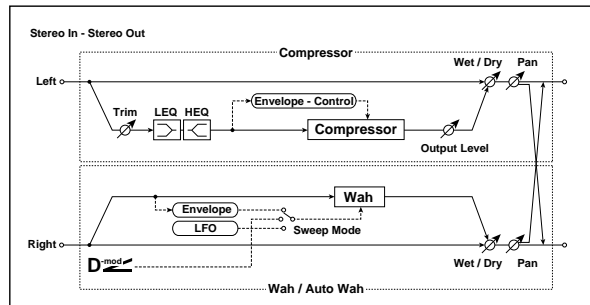

## 155: Comp // Chorus/Flanger

This effect connects a compressor and a chorus / flanger in parallel. The pan and effect balance can be adjusted independently for each.

For detailed information on the effects parameters, see “Compressor” on page 1004 and “Chorus/Flanger” on page 1006.

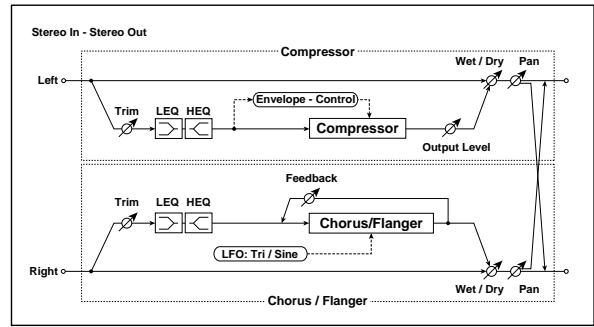

## 156: Comp // Phaser

This effect connects a compressor and a phaser in parallel. The pan and effect balance can be adjusted independently for each.

For detailed information on the effects parameters, see “Compressor” on page 1004 and “Phaser” on page 1006.

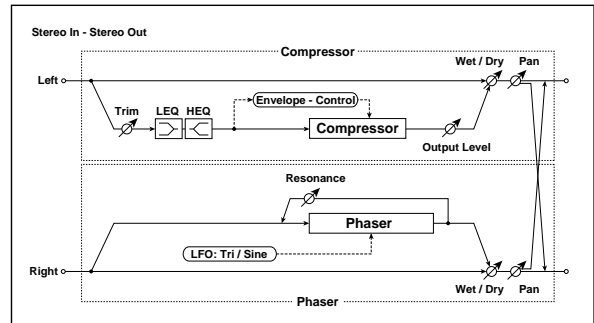

## 157: Comp // Multitap BPM Dly

This effect connects a compressor and a multitap BPM delay in parallel. The pan and effect balance can be adjusted independently for each.

For detailed information on the effects parameters, see “Compressor” on page 1004 and “Multi-tap BPM Delay” on page 1006.

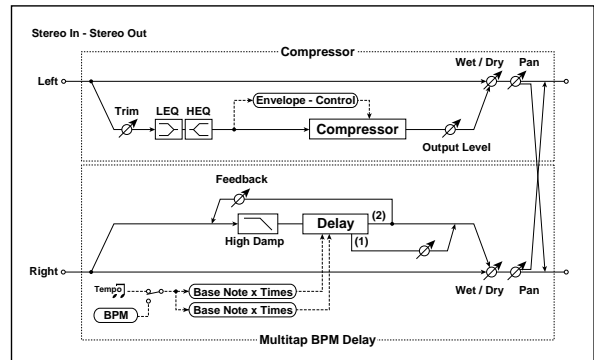

## 158: Limiter // Limiter

This effect connects two limiters units in parallel. The pan and effect balance can be adjusted independently for each.

For detailed information on the effects parameters, see “Limiter” on page 1004.

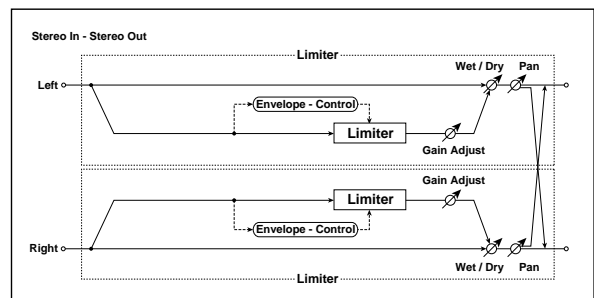

## 159: Limiter // Exciter

This effect connects a limiter and an exciter in parallel. The pan and effect balance can be adjusted independently for each.

For detailed information on the effects parameters, see “Limiter” on page 1004 and “Exciter” on page 1005.

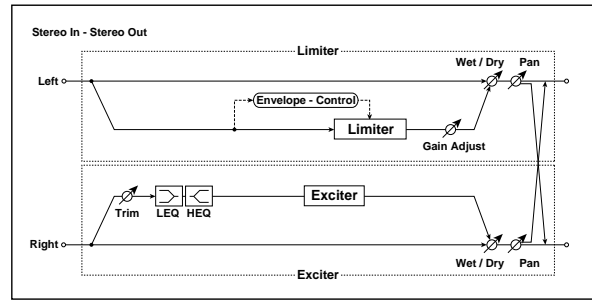

## 160: Limiter // OD/Hi Gain

This effect connects a limiter and an overdrive in parallel. The pan and effect balance can be adjusted independently for each.

For detailed information on the effects parameters, see “Limiter” on page 1004 and “OD/HI-GAIN” on page 1005.

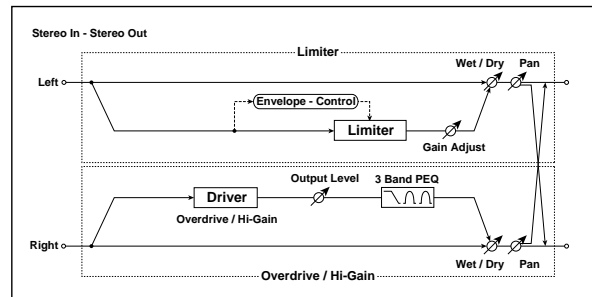

## 161: Limiter // Wah

This effect connects a limiter and a wah in parallel. The pan and effect balance can be adjusted independently for each.

For detailed information on the effects parameters, see “Limiter” on page 1004 and “WAH” on page 1005.

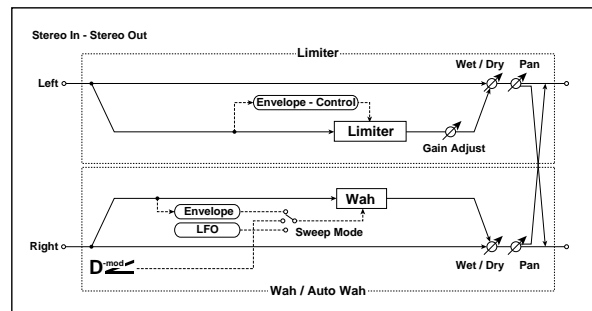

## 162: Limiter // Chorus/Flanger

This effect connects a limiter and a chorus/flanger in parallel. The pan and effect balance can be adjusted independently for each.

For detailed information on the effects parameters, see “Limiter” on page 1004 and “Chorus/Flanger” on page 1006.

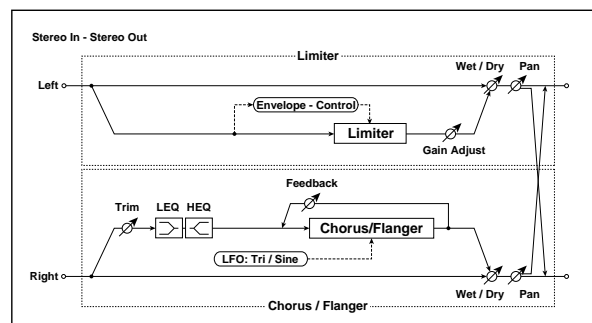



## 163: Limiter // Phaser

This effect connects a limiter and a phaser in parallel. The pan and effect balance can be adjusted independently for each.

For detailed information on the effects parameters, see "Limiter" on page 1004 and "Phaser" on page 1006.

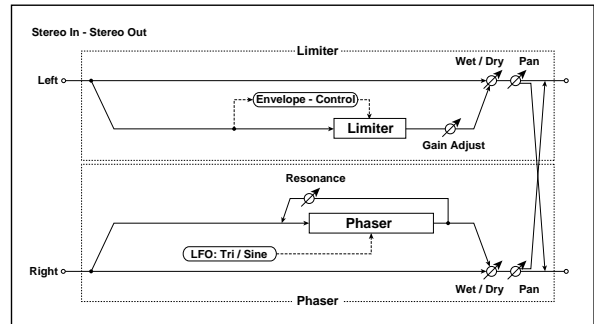

## 164: Limiter // Mtap BPM Dly

This effect connects a limiter and a multitap BPM delay in parallel. The pan and effect balance can be adjusted independently for each.

For detailed information on the effects parameters, see "Limiter" on page 1004 and "Multi-tap BPM Delay" on page 1006.

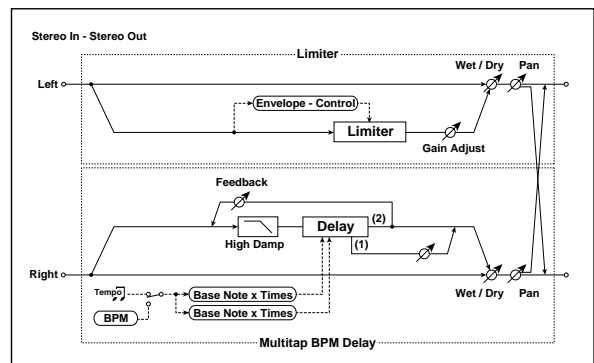

## 165: Exciter // Exciter

This effect connects two exciters in parallel. The pan and effect balance can be adjusted independently for each.

For detailed information on the effects parameters, see "Exciter" on page 1005.

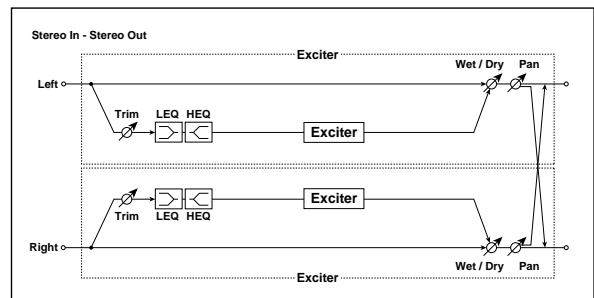

## 166: Exciter // OD/Hi Gain

This effect connects an exciter and an overdrive in parallel. The pan and effect balance can be adjusted independently for each.

For detailed information on the effects parameters, see "Exciter" on page 1005 and "OD/HI-GAIN" on page 1005.

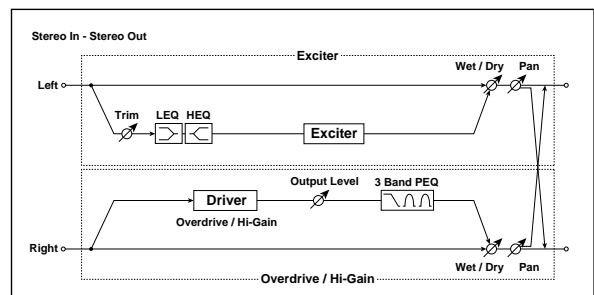

## 167: Exciter // Wah

This effect connects an exciter and a wah in parallel. The pan and effect balance can be adjusted independently for each.

For detailed information on the effects parameters, see “Exciter” on page 1005 and “WAH” on page 1005.

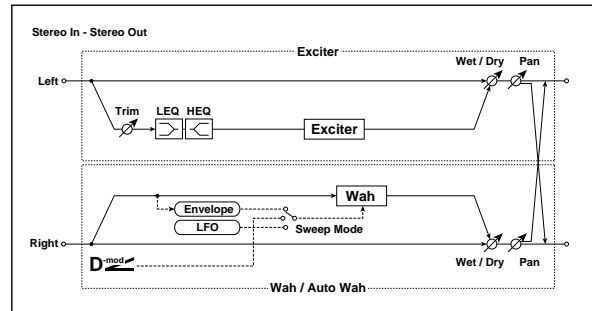

## 168: Exciter // Chorus/Flanger

This effect connects an exciter and a chorus/flanger in parallel. The pan and effect balance can be adjusted independently for each.

For detailed information on the effects parameters, see “Exciter” on page 1005 and “Chorus/Flanger” on page 1006.

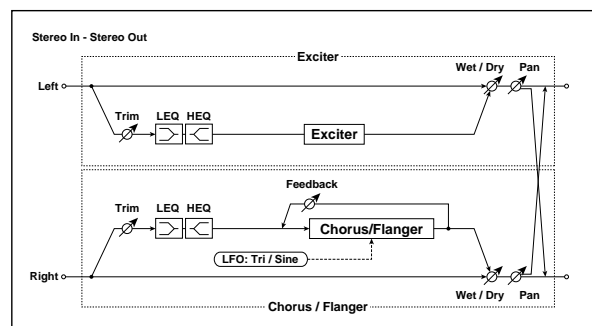

## 169: Exciter // Phaser

This effect connects an exciter and a phaser in parallel. The pan and effect balance can be adjusted independently for each.

For detailed information on the effects parameters, see “Exciter” on page 1005 and “Phaser” on page 1006.

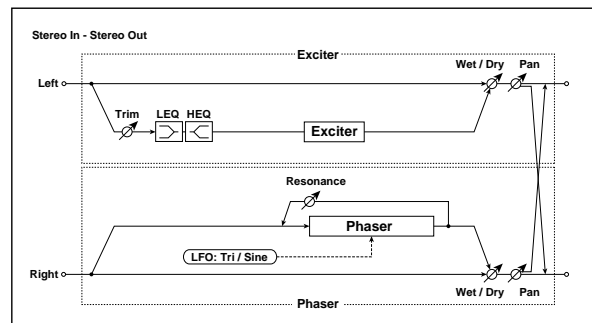

## 170: Exciter // Mtap BPM Dly

This effect connects an exciter and a multitap BPM delay in parallel. The pan and effect balance can be adjusted independently for each.

For detailed information on the effects parameters, see “Exciter” on page 1005 and “Multi-tap BPM Delay” on page 1006.

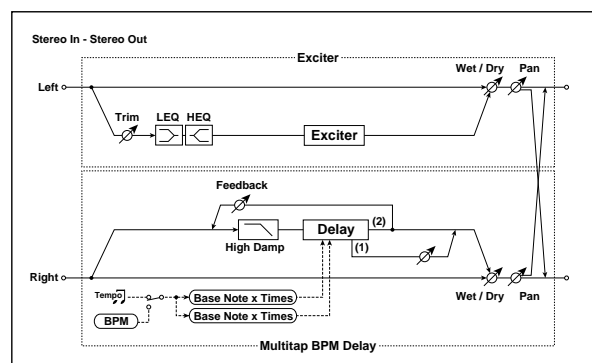

## 171: OD/Hi Gain // OD/Hi Gain

This effect connects two overdrives in parallel. The pan and effect balance can be adjusted independently for each.

For detailed information on the effects parameters, see "OD/HI-GAIN" on page 1005.

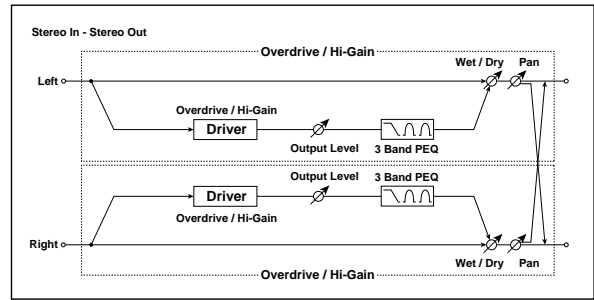

## 172: OD/Hi Gain // Wah

This effect connects an overdrive and a wah in parallel. The pan and effect balance can be adjusted independently for each.

For detailed information on the effects parameters, see "OD/HI-GAIN" on page 1005 and "WAH" on page 1005.

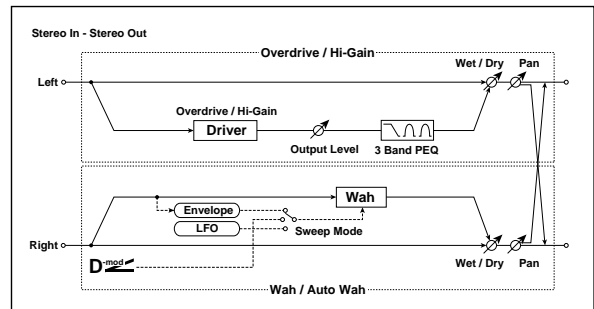

## 173: OD/Hi Gain // Cho/Flanger

This effect connects an overdrive and a chorus / flanger in parallel. The pan and effect balance can be adjusted independently for each.

For detailed information on the effects parameters, see "OD/HI-GAIN" on page 1005 and "Chorus/Flanger" on page 1006.

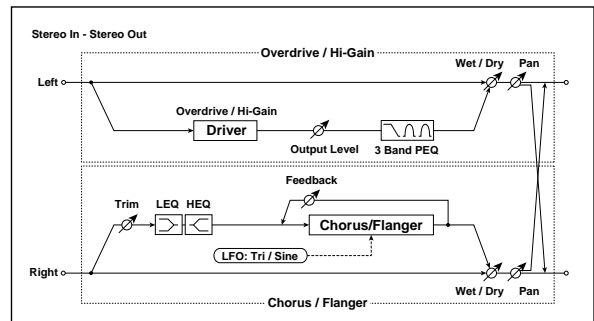

## 174: OD/Hi Gain // Phaser

This effect connects an overdrive and a phaser in parallel. The pan and effect balance can be adjusted independently for each.

For detailed information on the effects parameters, see "OD/HI-GAIN" on page 1005 and "Phaser" on page 1006.

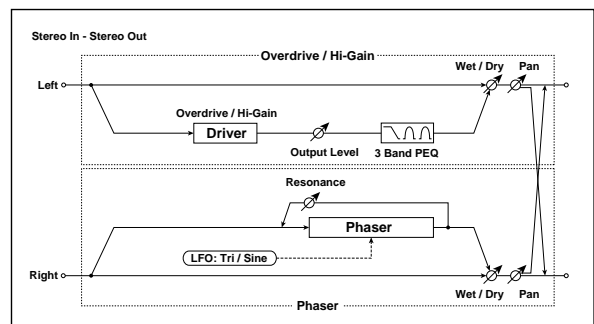

## 175: OD/Hi Gain // Mt BPM Dly

This effect connects an overdrive and a multitap BPM delay in parallel. The pan and effect balance can be adjusted independently for each.

For detailed information on the effects parameters, see “OD/HI-GAIN” on page 1005 and “Multi-tap BPM Delay” on page 1006.

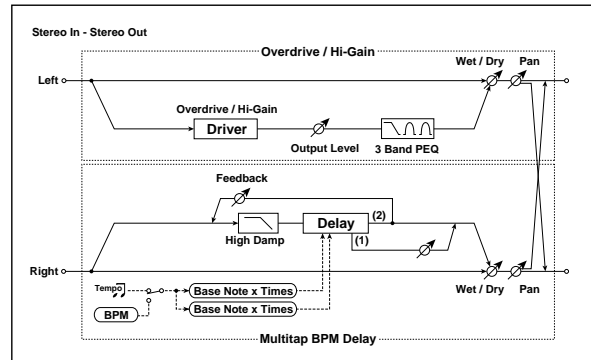

## 176: Wah // Wah

This effect connects two wahs in parallel. The pan and effect balance can be adjusted independently for each.

For detailed information on the effects parameters, see “WAH” on page 1005.

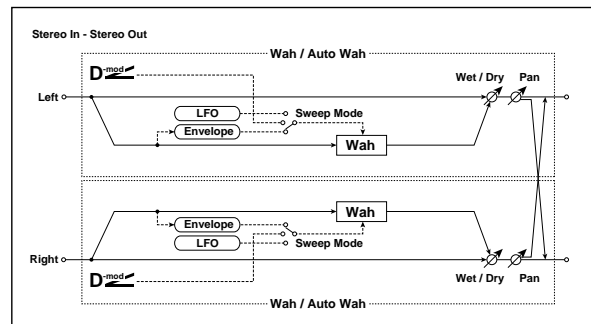

## 177: Wah // Chorus/Flanger

This effect connects a wah and a chorus/flanger in parallel. The pan and effect balance can be adjusted independently for each.

For detailed information on the effects parameters, see “WAH” on page 1005 and “Chorus/Flanger” on page 1006.

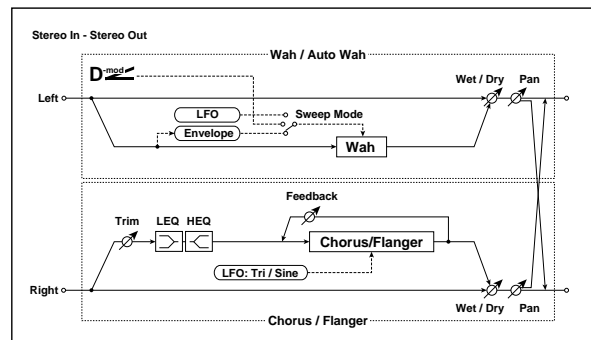

## 178: Wah // Phaser

This effect connects a wah and a phaser in parallel. The pan and effect balance can be adjusted independently for each.

For detailed information on the effects parameters, see “WAH” on page 1005 and “Phaser” on page 1006.

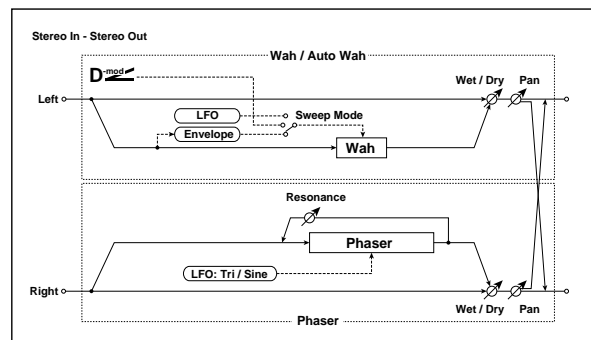

## 179: Wah // Multitap BPM Dly

This effect connects a wah and a multitap BPM delay in parallel. The pan and effect balance can be adjusted independently for each.

For detailed information on the effects parameters, see “WAH” on page 1005 and “Multi-tap BPM Delay” on page 1006.

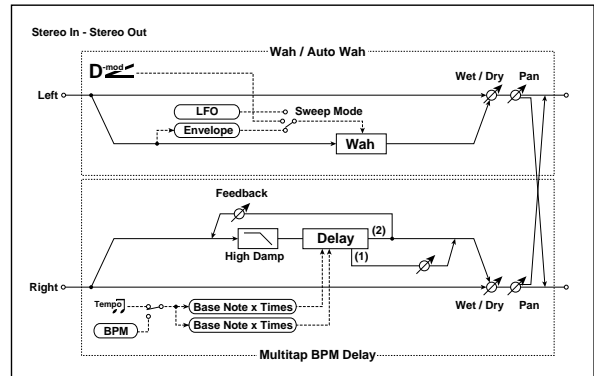

## 180: Cho/Flange // Cho/Flanger

This effect connects two chorus/flangers in parallel. The pan and effect balance can be adjusted independently for each.

For detailed information on the effects parameters, see “Chorus/Flanger” on page 1006.

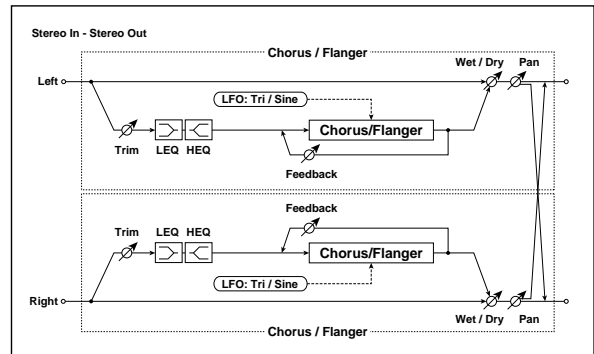

## 181: Cho/Flange // Phaser

This effect connects a chorus/flanger and a phaser in parallel. The pan and effect balance can be adjusted independently for each.

For detailed information on the effects parameters, see “Chorus/Flanger” on page 1006 and “Phaser” on page 1006.

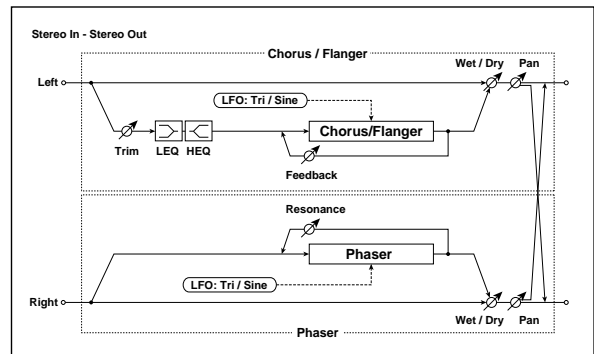

## 182: Cho/Flange // Mt BPM Dly

This effect connects a chorus / flanger and a multitap BPM delay in parallel. The pan and effect balance can be adjusted independently for each.

For detailed information on the effects parameters, see “Chorus/Flanger” on page 1006 and “Multi-tap BPM Delay” on page 1006.

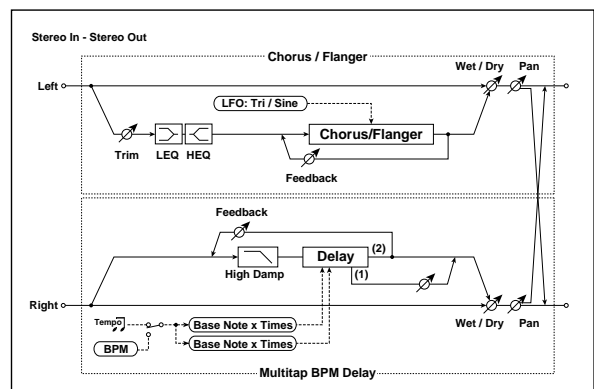

### 183: Phaser // Phaser

This effect connects two phasers in parallel. The pan and effect balance can be adjusted independently for each.

For detailed information on the effects parameters, see “Phaser” on page 1006.

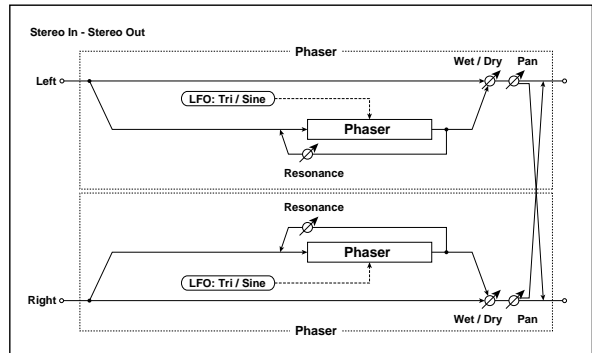

### 184: Phaser // Mtap BPM Dly

This effect connects a phaser and a multitap BPM delay in parallel. The pan and effect balance can be adjusted independently for each.

For detailed information on the effects parameters, see “Phaser” on page 1006 and “Multi-tap BPM Delay” on page 1006.

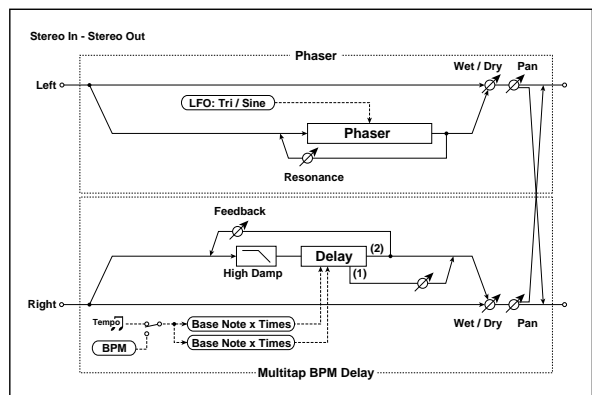

### 185: Mt.BPM Dly // Mt.BPM Dly

This effect connects two multitap BPM delays in parallel. The pan and effect balance can be adjusted independently for each.

For detailed information on the effects parameters, see “Multi-tap BPM Delay” on page 1006.

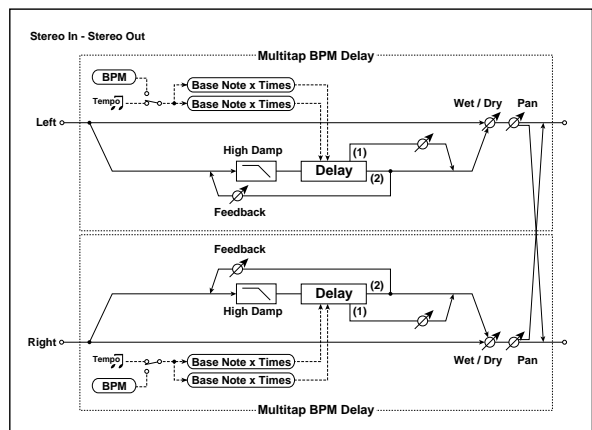

# KARMA GE guide

## About the KARMA GE guide

This section of the manual explains the GE parameters of KARMA built into the KRONOS, organized according to the groups that make up the Generated Effects.

The KRONOS provides **more than two thousand preset GEs (Generated Effects)**. For each GE, up to thirty-two of the more than four hundred internal GE parameters have been selected for optimal control from the KRONOS.

The GE parameters and ranges that can be controlled will differ for each GE.

Some GE parameters are related to other parameters, and are affected by them. In this case, the parameters that are producing the effect may not always be displayed, since they may already be preset for that GE.

Furthermore, the KARMA-related parameters in pages 7-0 – 7-9 of each mode may also function differently, or not at all, depending on the settings of these GE parameters.

Some of the internal parameters of each GE are displayed in the Voice Name List.

In order to explain the GEs, some of the examples in this document mention these internal parameters, even though they cannot be viewed or changed on the KRONOS.

### Illustrations in the GE guide

Some of the illustrations in this document include displays of data, such as pattern grids, which are not shown on the KRONOS LCD screen.

## How to read the “GE Guide”

The GEs (Generated Effects) are organized into fifteen groups. Each group has GE parameters. For more information, see “KARMA Architecture (Diagram)” on page 1022.

The 7-5: GE Real-Time Parameters page shows the group name, parameter name, and parameter value of the GE parameters.

You can use the 7-5: GE Real-Time Parameters page to check the group name and parameter name of the GE parameter you wish to look up, and then find it in the GE Guide.

Here’s an example from Program mode.

Access the Program 7-5: GE Real-Time parameters page, and display the GE parameters in the LCD screen. For more information, see “7-5: GE Real-Time Parameters/Scenes” on page 120.

The GE parameters displayed in the LCD screen show the group name and parameter name.

For example in the case of 01. Rhythm: Swing %, the group is Rhythm Group and the parameter is “Swing %.” (See “Swing %” on page 1035.)

The parameter value is displayed by “Value” at the right of the parameter name.

The “Real-Time Control Range” (minimum and maximum values that the parameter can be varied between by real-time control or direct editing) is displayed by “Min” and “Max” next to the “Value” field.

When loading a GE, the default value and editing range of the parameter is preset for each GE. Depending on the selected GE, the same GE parameter may have a different default value and a different editing range.

## How GE parameter names are displayed

For some GE parameters, the following information is shown in addition to the parameter name.

### Parameter name [Phase]

This is shown for most GE parameters within the following groups (some that are not related to phases will not show this information):

Phase Group  
Rhythm Group  
Duration Group  
Index Group  
Cluster Group  
Velocity Group  
CCs Group

WaveSeq Group

Display example

Rhythm: Template [B]  
                                  ↓  
                                  [Phase]

[1]: Phase 1 is controlled

[2]: Phase 2 is controlled

[B]: Both phases 1 and 2 are controlled



**CCs: parameter name #No. #No.**

Parameters of the CCs Group also indicate the MIDI message that are controlled by CC-A and CC-B.

Display example

**CCs: Fixed/On [B] 010 074**  
[Phase] #No. #No.

000...125: CC#000...CC#125

**PB:** Pitch Bend

**Env: parameter name [Env] #No. #No. #No.**

Parameters of the Env (Envelope) Group also indicate the being controlled by that GE parameter, and indicate the parameter or MIDI message that is controlled by the Envelope.

Display example

**Env: Env On/Off [3] 010**  
[Env] #No.

[Env]:

[1]: Envelope 1 is controlled

[2]: Envelope 2 is controlled

[3]: Envelope 3 is controlled

[1, 2]: Envelopes 1 and 2 are controlled

[2, 3]: Envelopes 2 and 3 are controlled

[1, 3]: Envelopes 1 and 3 are controlled

[A]: Envelopes 1, 2 and 3 are controlled

#No.:

**VE:** Velocity

**TA:** Tempo-Absolute

**TR:** Tempo-Relative

**PB:** Pitch Bend

**DU:** Duration

**RT:** Repeat Time

000...121: CC#000...121

**Drum: parameter name [Pat]**

Parameters of the Drum Group also indicate the drum pattern being controlled by that GE parameter. (Some parameters in the Drum Group that are not related to the individual Drum Patterns will not display this information.)

Display example

**Drum: Row 1 Note [1]**  
[Pat]

[1]: Pattern 1 is controlled

[2]: Pattern 2 is controlled

[3]: Pattern 3 is controlled

[1, 2]: Patterns 1 and 2 are controlled

[2, 3]: Patterns 2 and 3 are controlled

[1, 3]: Patterns 1 and 3 are controlled

[A]: All patterns are controlled

[B]: Patterns 1 and 2 (displayed only for Link to Next) are controlled

## About KARMA

---

### Overview

**KARMA** stands for **K**ay **A**lgorithmic **R**ealtime **M**usic **A**rchitecture, named after its inventor, Stephen Kay.

KARMA generates MIDI data, using many different complex algorithms seamlessly integrated to provide a powerful “music generation engine”. Based on the notes and chords you play, **KARMA** generates phrases and patterns in real-time, generating not just notes but MIDI control data as well. The **KARMA** architecture allows the various algorithms to be reconfigured and varied in realtime, as you play them.

For example, you can create spectacular cascades of complex interweaving notes, techno arpeggios and effects, dense rhythmic and melodic textures, natural sounding glissandos for acoustic instrument programs, guitar strumming and finger-picking simulations, random effects, auto-accompaniment effects, gliding and swooping portamento and pitch bend effects, and new sound design possibilities. **KARMA** lets you produce phrases and patterns far beyond the level provided by conventional arpeggiators or pattern playback functions.

---

### Theory Of Operation

A performance of a musical phrase can be thought of as having many different “attributes” which determine the overall effect of the resulting music. For example, a musical phrase has a “rhythm” attribute, which is the rhythm with which the notes are being played. The number of notes (“chords”) being played at the same time in various places of the musical phrase could be called a “cluster” attribute. The velocity (accent) with which the notes are played is a “velocity” attribute. The spatial location in a stereo field where the notes are played is a “pan” attribute, etc.

Typically, music that has been recorded or sequenced has all of these attributes predetermined and fixed in relation to each other. A specific note is to be played with a specific rhythmic value for a specific period of time, at a specific volume level, at a specific location in a stereo field, with the sound of a specific musical instrument, and these relationships remain fixed no matter how many times you play back the performance. For example, in most if not all auto-accompaniment instruments, to achieve a variation in the accompaniment pattern the instrument essentially switches to a different pre-recorded sequence of musical events (again with specific relationships that are fixed in the data).

In **KARMA**, every aspect of a musical phrase has been separated into independently controllable attributes. Each of these attributes is controlled by a separate group of parameters, which can be individually varied or changed in groups by the user in real-time as the music is being generated; or changed all at once with the selection of a program or combination.

**KARMA** can also be used to generate infinitely variable randomized grooves and accompaniment backings. Up until now there have been two basic types of backing track generation. The traditional method used in all auto-accompaniment keyboards is a system which analyzes notes played on a keyboard (chord recognition) and then plays back patterns stored in memory through transposition tables. The second method is the one used by some algorithmic software products that create new patterns each time the algorithm is called. In general, the first method is static and repetitive, while the second method cannot be modified in real-time.

**KARMA** combines the algorithmic diversity of the second method with the real-time control and immediate access of the first method to create a new form of interactive groove generation, where the user is in more direct control, since what is produced is directly related to which notes are pressed. Furthermore, extensive aspects of the rhythm, velocity, chord size and other parameters can be randomly varied in real-time to allow the user to control the complexity and density of the resulting performance.

Whether you are playing programs or combinations, performing with the **KARMA** Controls sliders, switches, and drum/chord pads, giving a live performance, or recording new music using the onboard sequencer, you can take full advantage of **KARMA** at any time.

# KARMA Architecture (Diagram)

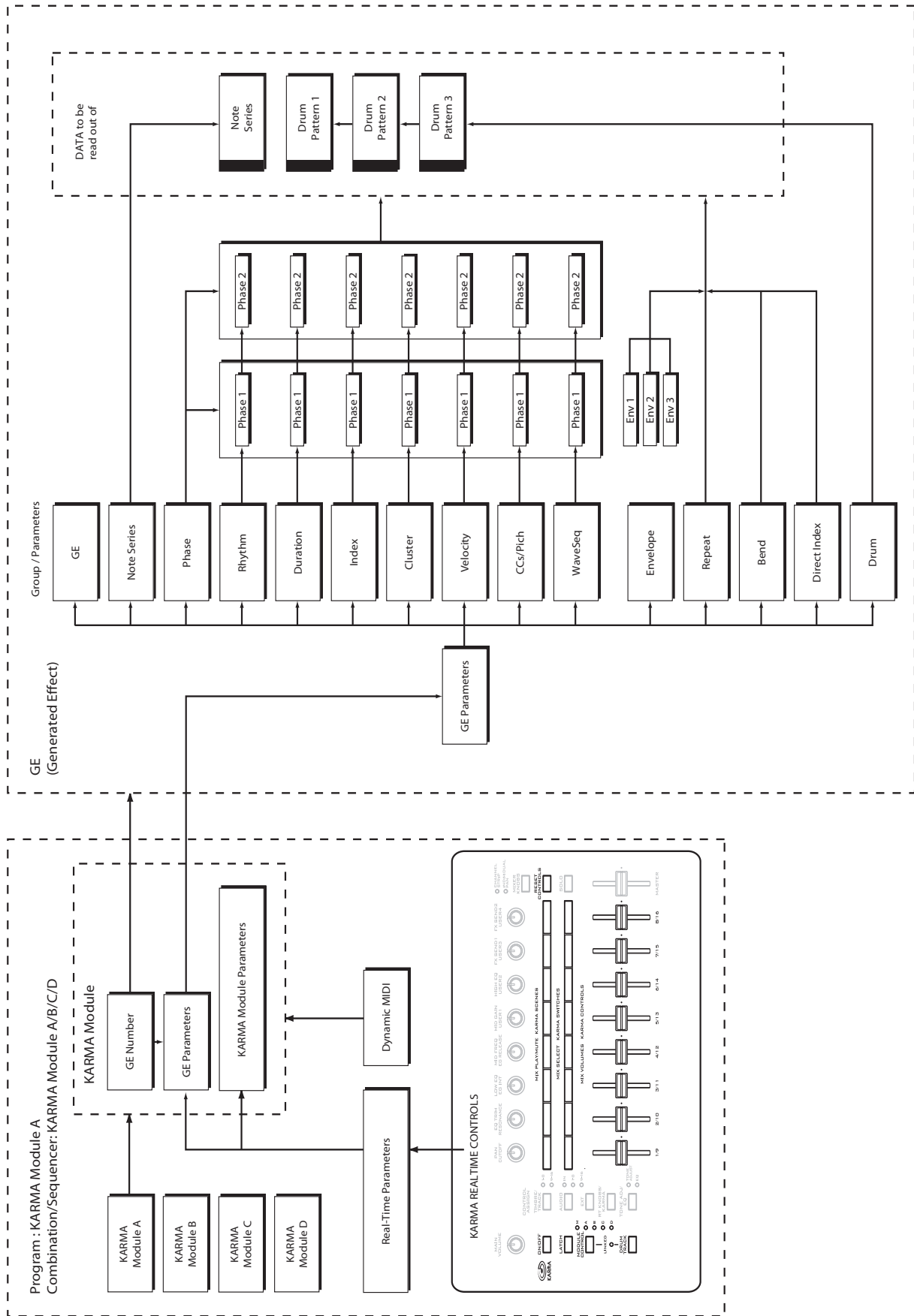

## GE (Generated Effect) Group

### Overview

The phrases and patterns produced by a KARMA module are generated by a **GE (Generated Effect)**.

Based on note data from the keyboard or external MIDI device, the GE uses various internal parameters to control how the note data will be developed, and how rhythm, chord structure, and velocity etc. will be controlled to generate a phrase or pattern. MIDI control changes and pitch bend data can also be

generated in synchronization with the phrase or pattern, making it possible to create phrases and patterns in which the tone color and note pitches change independently.

This instrument contains over **2000 preset GEs** that can be used with a wide range of instruments, playing styles, and musical genres

### GE Global Parameters

#### GE Type

[0...3]

- |                    |                   |
|--------------------|-------------------|
| 0: Generated-Riff  | 2: Generated-Drum |
| 1: Generated-Gated | 3: Real-Time      |

Selects one of several different overall algorithm configurations for the current Generated Effect. This setting determines some basic modes of operation, and which parameters are available within the various GE Groups.

#### 0: Generated-Riff

Produces riffs, arpeggios, and chord clusters based on the notes given as input source material. The notes are expanded, transposed, replicated, and otherwise altered to form a Note Series by the parameters in the Note Series Group. Effects are generated based on the Rhythm Pattern as it relates to the clock source or tempo envelope.

#### 1: Generated-Gated

A Note Series is created as in **0: Generated – Riff** above, but only a portion of the Note Series is retriggered according to the parameters. Effects are generated based on the Rhythm Pattern as it relates to the clock source or tempo envelope. The notes themselves can be generated repetitively in several different ways, or as a sustained set of notes which is then “sliced and diced” by a selected controller value. This can be used to simulate several types of popular techno effects, such as gating a synth pad with a hi-hat track and an external audio gate/compressor. This GE Type can also be used to simulate the Korg Triton Arpeggiator, along with “Gate Type” = **Vel CP**, explained below.

#### 2: Generated-Drum

Uses special patterns of predetermined pitches rather than the Note Series to generate notes. These can be used not only to create Drum Patterns, but also to create controlled musical patterns. Effects are generated based on the Rhythm Pattern as it relates to the clock source or tempo envelope. Riffs based on the notes in the Note Series can be applied as pitch bend, to create wave-sequence and other unique effects, and also to control other things such as the length of Phases.

#### 3: Real-Time

Different from the previous types in that the actual notes given as input source material are used as a starting point, from which effects are generated over time according to time calculations. Examples include glissandos and arpeggios which start with the note(s) given as input (Melodic Repeat), and Auto-Bending an input note a certain amount or to another note.

#### Gate Type

[0...4]

- 0: Vel - retrigger ALL input notes with Velocity
- 1: Vel CP – retrigger Cluster Pattern notes with Velocity
- 2: CC [T]-sustain notes; retrigger only if Phase Transpose is different
- 3: CC [1]-sustain notes; retrigger when entering Phase1
- 4: CC [2]-sustain notes; retrigger when entering Phase2
- 5: CC [A]-sustain notes; retrigger when entering any Phase

Selects one of several different Gate Type settings. Two “Vel” options retrigger the notes repeatedly, while the “CC” options allow sustained notes to be chopped or stepped with CC Values.

 Available only when “GE Type” (p.1023)= **1: Generated-Gated**.

#### 0: Vel - retrigger ALL input notes with Velocity

The actual notes given as input source material (all of them) are generated repetitively as note-ons and note-offs according to the parameters. In other words, if you play eight notes, all eight notes will be repeatedly generated at once. This produces a “gated” effect where each cluster of notes possesses the attack portion of the program being used, as if someone was repeatedly striking a keyboard very quickly. A Velocity Pattern can be used to impart different velocities to the clusters of notes. The Cluster Pattern Grid is disabled and has no effect on how many notes are generated.

#### 1: Vel CP – retrigger Cluster Pattern notes with Velocity

The Cluster Pattern Grid is used to indicate which notes are to be generated from a portion of the Note Series corresponding to the number of input notes played. In other words, the ten rows of the Value portion of the Cluster Pattern grid allow you to specify which of up to ten notes you may have played are to be generated. If a step of the Cluster Pattern has rows 0, 2 and 4 selected, then the first, third, and fifth notes in the Note Series will be generated at that step. What

these notes actually are will be influenced by the Note Series and Input Sort settings. This can be used to simulate the operation of the Korg Triton Arpeggiator, for example. Note that filling all ten rows of each column is essentially the same as using **0: Vel above**.

**2...5: CC - 4 different CC Gate Types**

When one of the four “CC Gate Types” is chose, the “Gate CC Number” parameter specifies a MIDI Control Change Message (CC) to be used in place of note-ons and note-offs. The actual notes given as input source material are then generated as note-ons only once at the beginning of the effect; the rest of the note-ons are turned into the specified CC controller value with the same value as the velocity of the note-on; the note-offs are turned into CC values of 0. Essentially, this means that a pad will be sustained, having the attack portion triggered only once. For example, if the selected CC was #11 (Expression) or #07 (Volume), the pad will be repeatedly turned on and off, simulating the popular techno effect of gating a synth pad with a hi-hat track and an external audio gate/compressor. In KARMA however, the Velocity Pattern can be used to control the value of each CC that is generated for a note-on (the volume of each “slice”), and the Duration Pattern (see “Duration Pattern” on page 1040) can be used to control the duration of each “slice.”

Other CCs can produce other interesting stepped and wave-sequence like effects. For example, using CC#74 to control Filter Cutoff Frequency can produce interesting “Sample & Hold” effects.

**2: CC [T]-sustain notes; retrigger only if Phase Transpose is different**

When this first CC option is chosen, the “pad” will only be triggered manually (i.e. when you strike the keyboard), or only if there is a Phase Change and the Phase Transpose is different (see “Phase Transpose” on page 1032), requiring that the generated notes be transposed. Therefore, if the Phase Transposes are the same, the “pad” will never retrigger unless you trigger it manually.

**3: CC [1]-sustain notes; retrigger when entering Phase1**

Same as CC [T] above, with the exception that the “pad” will be retriggered when striking the keyboard, and every time that the Phase Pattern enters a step containing Phase 1. You can use this to have the notes retriggered occasionally while moving through the Phase Pattern.

**4: CC [2]-sustain notes; retrigger when entering Phase2**

Same as CC [T] above, with the exception that the “pad” will be retriggered when striking the keyboard, and every time that the Phase Pattern enters a step containing Phase 2. You can use this to have the notes retriggered occasionally while moving through the Phase Pattern.

**5: CC [A]-sustain notes; retrigger when entering any Phase**

Same as CC [T] above, with the exception that the “pad” will be retriggered when striking the keyboard, and every time that the Phase Pattern causes a Phase Change. You can use this to have the notes retriggered occasionally while moving through the Phase Pattern.

**Gate CC Number [-1, 0...127]**

-1: Off      0...126: MIDI CC #00...126

Select which CC will be transmitted instead of the note-ons and note-offs of the generated notes. For example, for “chopping” effects, set to **11: 11 (CC#11)**.

**-1: Off**

No MIDI CCs are generated.

**0...126: MIDI CC #00...126**

The specified MIDI CC is generated in place of the Module’s note-ons and note-offs. Note-offs are generated as a value of “0,” while note-ons are generated as a value equal to the velocity of the note-on.

 Available only when “Gate Type” is **one of the 4 CC options**.

**Force Mono [0, 1]**

0: Off      1: On

Selects whether the GE will operate polyphonically according to its other internal settings, or whether the generation of more than one note at a time and overlapping durations will be suppressed.

**0: Off**

Notes will be generated as expected according to the internal settings of the GE. Polyphonic clusters of notes may be generated according to the Cluster Pattern, repeated notes may be generated on top of other notes, and the durations of notes may overlap according to Duration settings.

**1: On**

The normal behavior of certain aspects of the GE will be overridden, suppressing the generation of multiple notes at the same time. Any clusters being generated will be removed, essentially generating what would be the single lowest note in the cluster. Any notes from Melodic Repeat that happen to be generated on top of another note will be suppressed. Multiple repeated notes happening at the same instance will only play one of them. Durations of generated notes will not be allowed to overlap, but may only extend up until the next note to be generated. Any note will cut off the previous note’s duration if it is sustaining. The result is that only one note at a time will be generated or sustaining at any given moment.

**Note:** When polyphonic GEs are applied to monophonic programs, the results may be strange due to the overlapping notes and durations. By turning on “Force Mono,” any GE can be applied to a monophonic program and made to sound good. However, it can also sound good as an effect on polyphonic programs, because it can simplify a dense GE in an interesting sounding way. For example, you can turn a comping keyboard part into a single note bass line.

**Note:** "Force Mono" and Rhythm Group: "Humanize"

When "Force Mono" is **1: On**, the effects of Rhythm: "Humanize" are removed if Melodic Repeat is being used at the same time. A GE can be stored with a normal amount of "Humanize," so that it can be used that way with the "Force Mono" parameter off, and then "Force Mono" can be turned on in real-time. The reason for this is that the "Force Mono" effect uses the first note arriving within a section of time (i.e. 16th notes) to window out the rest of the notes. If the underlying main notes are slightly late as a result of "Humanize," it is possible for overlapping repeated notes to arrive slightly before them, and then the main notes get masked out while the repeated notes take precedence. Since "Humanize" is a randomly varied amount, this results in a completely unpredictable sequence of notes in this case, that cannot produce consistent results. By removing the "Humanize" amount when "Force Mono" is on with Melodic Repeat, the result is consistent and predictable.

With drums, when "Force Mono" is **1: On**, Humanize is removed even if not using repeats. This is because each note in a column of a drum pattern is affected individually by the Humanize parameter, and the "Force Mono" effect requires them to all line up on the same instant in order to allow only one of them to be produced.

**Note:** "Force Mono" and Cluster Group: "Strum"

When "Force Mono" is **1: On**, the effects of the "Strum" parameter are removed, since no clusters can be generated.

## Note Series Group

### Overview

The **Note Series Group** controls the creation of a “**Note Series**” in memory, which is the foundation of a large percentage of Generated Effects. The Note Series is a collection of pitches and corresponding velocities, created from initial notes coming from input source material (i.e. a keyboard, or sequence data which is being used as input). The various parameters control how these initial notes are replicated, shifted, sorted, filtered, and otherwise arranged into the Note Series. The Note Series is then used as the basic collection of pitches and velocities from which notes are generated, as controlled by most of the other parameters of the Generated Effect.

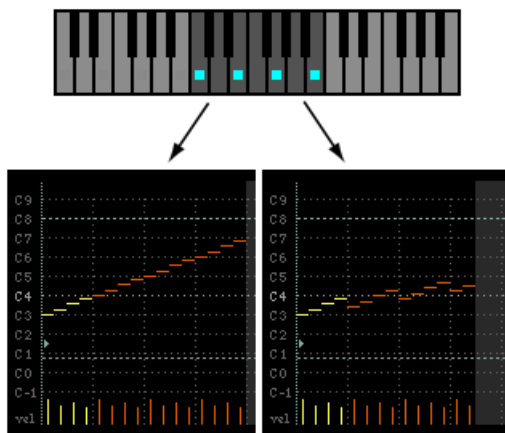

The diagram on the left shows “Replications” (p.1027) of **400** (4.0) with an “Interval” (p.1028) of **+12**, producing a 16-note Note Series from the four input notes ( $4 \times 4.0 = 16$ ). Each Replication of the original four notes is shifted by +12 semitones from the previous Replication, yielding a four octave arpeggio.

The diagram on the right shows “Replications” of **350** (3.5) with an “Interval” of **+5**, producing a 14-note Note Series from the four input notes ( $4 \times 3.5 = 14$ ). Each Replication of the original four notes is shifted by +5 semitones from the previous Replication, with the two notes at the end being produced by a half Replication.

### Parameters

The following parameters create and change the Note Series.

When “GE Type” (p.1023) = **2: Generated-Drum**, the effect of changing most of these parameters is only apparent if the Note Series is being applied as pitch bend in the Phase Group/Bend Group, or riff length is being used in the Drum Group.

The following 3 parameters will have an effect on when Phases change if the Phase “Length Mode” (p.1031) is set to **0: AC-Actual**: “Replications” (p.1027), “Filter Steps” (Filter Template), and “Filter Dupes”. See Phase Group.

#### Note Type [0...9]

- |              |               |             |
|--------------|---------------|-------------|
| 0: Regular   | 4: Whole Tone | 8: Tritones |
| 1: Scalic    | 5: Diminished | 9: Fifths   |
| 2: Scalic 2  | 6: Augmented  |             |
| 3: Chromatic | 7: Fourths    |             |

Selects one of several modes for supplying the initial notes from which the Note Series is created.

#### 0: Regular

The Note Series created in memory will be produced based on the actual notes given as input source material (i.e. a keyboard, or sequence data which is being used as input).

#### 1: Scalic

The Note Series created in memory will be produced based on chord analysis of the input source material; then a group of notes corresponding to the analyzed chord will be used instead of the actual notes. The initial octave is based on the lowest note received as input source material. This can be used so that one finger chords produce scalic riffs, or to supply notes that are not present in the source material.

#### 2: Scalic 2

Same as **1: Scalic** (above), except an attempt is made to keep a seven note scale for each chord type. In other words, there will be more passing tones, and it will sound more “modal” in nature. For a good example of the difference, play a 4 note diminished chord with each one. This can be of use for creating a bass line that is more predictable when changing chords, or jazzy soloing kinds of effects.

#### 3: Chromatic

The 12 steps of a chromatic scale will be used as input source material. The first note of the Note Series is based on the lowest note received as input source material.



**4: Whole Tone**

The 6 steps of a whole tone scale will be used as input source material. The first note of the Note Series is based on the lowest note received as input source material.

**5: Diminished**

The 4 steps of a diminished chord will be used as input source material. The first note of the Note Series is based on the lowest note received as input source material.

**6: Augmented**

The 3 steps of an augmented chord will be used as input source material. The first note of the Note Series is based on the lowest note received as input source material.

**7: Fourths**

3 steps of stacked fourths will be used as input source material. The first note of the Note Series is based on the lowest note received as input source material.

**8: Tritones**

2 steps of a tritone (augmented fourth) will be used as input source material. The first note of the Note Series is based on the lowest note received as input source material.

**9: Fifths**

2 steps (root and fifth) will be used as input source material. The first note of the Note Series is based on the lowest note received as input source material.

**Note:** If "Root Position" is On, then the pitches of the Note Series will be shifted so that different inversions of the same chord produce the same set of pitches. For more information, see "Root Position" on page 114.

**Input Sort [0...4]**

0: Up      1: Down      2: Actual      3: Random

Sets how the notes (and corresponding velocities) from the input source material are arranged prior to creating the Note Series.

**0: Up**

Notes are arranged from lowest to highest.

**1: Down**

Notes are arranged from highest to lowest.

**2: Actual**

Notes are left in the order received. With a "Note Type" of Regular, the Note Series will therefore be capable of being created in many different orders, since the order of the input notes can vary. With any other type, the input notes are not actually used and a scale is substituted instead (as explained above). For these Note Types, using "Actual" will result in a different order than "Up" or "Down," but it will be the same order each time for each chord type.

**3: Random**

Notes are randomly arranged. This guarantees the initial order will be different each time.

**Input Transpose [-48...+48]**

Allows the input notes to be shifted by a specified number of semitones prior to the creation of the Note Series. The transposed input notes are then replicated and shifted according to the other parameters described below. This can be used, in conjunction with other Note Series Parameters, to shift and flip the Note Series into other configurations or inversions in real-time.

**Inversion [-24...+24]**

Allows different "inversions" of the input notes (after they are sorted) prior to creation of the Note Series. For example, if the notes {C, E, G, B} were received in that order as a chord and Inversion was 1, then the notes would be shifted to {E, G, B, C 8va} before creation of the Note Series (thus playing the 1st inversion). This is especially useful for setting multiple modules to play different inversions of the same effect, such as natural harp glissandos or riffs in harmony. Normally used with Input Sort set to 0: Up or 1: Down. The effect of this parameter when Input Sort is 2: Actual or 3: Random is less predictable, although potentially useful for some effects.

**Replications [0...4000]**

0...4000: 0.0...40.0

Sets how many times the input notes will be replicated according to the Interval. For example, 3 "Replications" with an "Interval" of 12 will give you a 3 octave arpeggio. Can be a fraction to achieve only a portion of the last replication. The value is represented as being x100 - so 350 is 3.5, 475 is 4.75, etc. Note that if "GE Type" (p.1023) = 1: Generated-Gated, this has no audible effect on the pitches of the Generated Effect; however this still affects the overall range of the available notes for Direct Indexing of the Note Series (described elsewhere).

**Max [1...255]**

Sets an overall "final place" in the Note Series, beyond which indexes will never be chosen during playback, even if other settings might allow it. This is a playback only parameter which does not affect the creation of the Note Series. This is one way to change the overall length of the Note Series in real-time.

**Symmetry [0, 1]**

0: Off      1: On

When set to 1: On, additional notes are extrapolated at the end of the Note Series beyond the number specified by the "Replications" setting, which are accessed when clusters are generated in that area of the Note Series, or when the Index Group "Double/Invert" parameters (p.1045) are used. This primarily allows different cluster sizes to be used without affecting the length and shape of the resulting riff. This interacts with Cluster Patterns and the Index Pattern Cluster Advance Mode, discussed elsewhere. Note that when this is 0: Off, clusters will "wrap around" at the end of a phase, or cause Phase Changes or cycling. Doubled notes caused by the use of the "Double" parameter in the Index Group will also be wrapped around at the top of the Note Series when this is off.

**0: Off**

The notes determined by the Repetitions setting (described above) are used as the range within which to generate notes.

**1: On**

Extra notes may be extrapolated at the end of the range depending on the cluster size at that point. The result will be a widening of the apparent range of the riff.

**Interval [-24...+24]**

Sets the number of semitones to offset each replication of the input notes by. For example, if set to +12 or -12, the Arpeggio will repeat in octaves (most normal). If set to 2, and "Repetitions" to 3, then playing a CMaj {C, E, G} will produced a CMaj, then DMaj {D, F#, A}, then EMaj {E, G#, B} as each replication is shifted by a whole-tone. Settings other than multiples of 12 are extremely useful in conjunction with "Chord Shift," described below, so that atonal notes are shifted to musically correct pitches.

**Chord Shift [0...2]**

0: Off      1: Scalic      2: Scalic2

Allows notes in the Note Series that may be atonal (out of a chord's scale) to be shifted to tonal notes, using one of several different tables.

**0: Off**

The Note Series is created with no further modification from this setting.

**1: Scalic**

Chord analysis is performed on the input source material, and as the Note Series is created, notes which may be "atonal" based on the analyzed chord (due to being shifted by non-octave values of "Interval") are shifted to tonal notes. Especially useful when "Interval" (discussed above) is set to something other than multiples of 12. The note tables used to shift the notes are the same as the ones used in "Note Type" (p.1026): **1: Scalic**, described above.

**2: Scalic2**

Same as **1: Scalic** (above), except that the note tables used to shift the notes are the same as the ones used in "Note Type": **2: Scalic2**, described above. **Scalic2** is more modal in nature and has more passing tones than **1: Scalic**.

**Wrap Bottom [0...127]**

**Wrap Top [0...127]**

0...127: range C-1...G9

Sets an overall range for the pitches in the Note Series. Notes created beyond this range are wrapped around (dropped or raised an octave, depending on which end). Mainly intended to limit the Note Series to usable ranges, these settings can also be used creatively to force a riff to cycle around inside a certain range.

**Voicing [0...8]**

0: Closed      3: Open2A      6: Open3B  
 1: Open1A      4: Open2B      7: Open4A  
 2: Open1B      5: Open3A      8: Open4B

Selects one of several options for "spreading out" the input notes before creating the Note Series. This can be used to widen the voicing, create guitar-like voicings, or produce interesting variations.

**0: Closed**

The Note Series is created with no further modification from this setting.

**1: Open 1A...8: Open4B**

The Note Series has certain notes shifted up by an octave as it is created, then may be re-ordered according to the setting of "Input Sort" (p.1027). Can be used to create different types of wider voiced chords for simulating guitar or string section voicings.

**Filter Dupes [0...2]**

0: Off      1: Adjacent      2: All

Allows duplicate notes in the Note Series to be removed in several different ways.

**0: Off**

The Note Series is created with no further modification from this setting.

**1: Adjacent**

As the Note Series is being created, notes that are the same as the immediately preceding note are discarded.

**2: All**

After the Note Series has been created, any notes that are duplicates of any others are removed.

 Not available if "GE Type" (p.1023) = 1: **Generated-Gated.**

**Filter Fixed [0, 1]**

0: Off      1: On

When Filter Steps is used (described below), allows the resulting tonality of the Note Series to be "Fixed" in relation to the key of C. For example, assume that "Note Type" (p.1026) is set to **Chromatic** and "Chord Shift" is **Off**, so that the Note Series is essentially a chromatic scale. If you play a single C (and "Inversion" is set to 0 p.1027), you will get a chromatic scale starting with C. If you then set up Filter Steps so that you are filtering steps {1, 3, 6, 8, 10} you would have a **C Major diatonic scale**. With "Filter Fixed" set to **Off**, if you then play a **D** on the keyboard, the whole scale will shift to become a **D Major diatonic scale**. With "Filter Fixed" set to **On**, the scale stays fixed to the key of C, but you are starting on the **D**; essentially, you have a **D minor scale**. You will be playing different modal scales starting with different pitches. Note that this is always related to the key of C; so if you want to put the resulting filtered, fixed Note Series into another key, you can use the Transpose KARMA Module parameter to do so. For more information, see "Transpose" on page 113. For example, if you set the transpose to +4, you would still play notes in the key of C, but the resulting generated notes would be in the

key of E. In the above example, playing a C would result in a E diatonic scale, playing a D results in an F# minor scale (F# Dorian mode) and so on.

⚠ Not available if "GE Type" = 1: **Generated-Gated**. For more information, see "GE Type" on page 1023.

**Filter Template [0...77]**

Allows the entire Filter Steps grid (see "About Filter Steps" on page 1029) to be changed to one of 78 different settings. Template 0 is all steps off (no steps filtered), while Template 77 is all steps on except the root (only the root is allowed in the Note Series). As the Templates proceed from 0 to 78, more and more steps are filtered out, in different combinations.

**Filter Temp + Restore [-1...77]**

Operates the same as "Filter Template" (above), with the difference that when the GE Real-Time Parameter is set to the minimum value specified by the GE Real-Time Parameters page range parameters (see "MIN (Minimum Value)" on page 120), the internal setting of the GE for the Filter Steps grid will be restored. In other words, you can have a certain Filter Steps setting already set up on the grid. Using "Filter Temp + Restore" as a GE Real-Time Parameter, you specify a range where the Min value restores the internal settings, and the rest of the range selects Templates, replacing the internal settings. So if the "Min Value" was 5 and the "Max Value" was 10, choosing 5 would restore the internal settings, and 6 through 10 would select the corresponding Filter Steps Template. You can use this to keep the internal settings of the GE, while still allowing a wide variety of Filter Templates to be substituted. In this case, the available range is -1-77. You can assign the full range of all 77 Templates, with indicating "Restore," or only a portion of the range, and still have the ability to restore the original internal settings.

**About Filter Steps**

Step	#1	#2	#3	#4	#5	#6	#7	#8	#9	#10	#11	#12
Key: C	C	C#	D	D#	E	F	F#	G	G#	A	A#	B
Key: E	E	F	F#	G	G#	A	A#	B	C	C#	D	D#



A 12 step grid corresponds to the scale tones with regard to a current "key," which is determined by Chord Analysis of the input source material. For example, if the key is determined to be C, then the steps 1 through 12 correspond to C, C#, D to B; if the key is determined to be "E," then steps 1 through 12 correspond to E, F, F# to D#. After the Note Series is created, notes belonging to the chosen steps are removed, thus "filtering" them out. For example, if {C, E, G, B} was the input material, CMaj7 would be the analyzed chord; if step #4 "3rd" was selected on the grid (as shown in the above diagram), all occurrences of E would be removed from the Note Series. Useful

for creating complex grooves where several modules are all supplied with the same source material, where for example you might not want the bass line to play the 3rd even if it is supplied from the keyboard, might want to remove all chance of 7ths from a comping guitar part, etc.

- ⚠ Selecting all steps to be filtered will result in a single note in the Note Series, determined by the settings of other parameters such as "Input Sort," "Inversion," etc.
- ⚠ To "fix" the resulting filtered collection of notes with regards to a specific key, use "Filter Fixed" (described above).
- ⚠ Not available if "GE Type" = 1: **Generated-Gated** (see "GE Type" on page 1023).

## Phase Group

### Overview

A Generated Effect has two different “Phases.” Each of them is a separate collection of certain parameters including Rhythm, Velocity, Cluster, Pan and Index Patterns, among others. As the effect is generated, a Phase Pattern controls switching between the two Phases, so that completely different collections of

parameters can be used for a period of time. The Phase Group contains parameters that control the length, direction, and various other attributes of each Phase, the number of times and in what order the Phases will play, and whether or not a portion will be looped.

### About Phase Patterns

Phase Pattern = 8

Step 1 2 3 4 5 6 7 8 9 10 11 12 13 14 15 16

Phase 1/2 1 1 1 1 1 1 2

The Phase Pattern allows a pattern of switching between the 2 Phases of a Generated Effect to be constructed. The resulting Phase Pattern may have a

minimum of 1 step and a maximum of 16 steps. The example above shows an eight step Phase Pattern: 7 times through Phase 1 followed by once through Phase 2. After completing the eight steps, execution may loop back to Step 1. Note that the actual number of steps performed and whether it loops back at the end will be determined by other settings described in this chapter.

### General Parameters

This group of parameters affects some overall characteristics of Phase performance.

#### Total Steps [0...32]

0: (∞) 1...32: number of steps

Sets the total number of steps of the Phase Pattern that will be played before stopping. The infinity sign 0: (infinity) sets it to loop forever; otherwise the setting represents a number of steps of the selected Phase Pattern. For example, if the Phase Pattern is a simple two-step pattern of {1, 2}, and the Total Steps menu is {4}, then four Phases would be played in the following order before stopping: {1, 2, 1, 2}.

#### Start % [0...100 (%)]

Controls the location in the Note Series at which the effect will start when it is triggered. Closer to 0% starts nearer the beginning while closer to 100% starts nearer the end; beginning/end relates to highest/lowest depending on the Phase “Direction” (p.1032) setting. This can be applied just once when first triggering the effect, or as various steps of the Phase Pattern are entered, in conjunction with the Start Mode described below.

 Not available when “GE Type” (p.1023) = 1: **Generated-Gated**. If 2: **Generated-Drum**, the Note Series can be applied as pitch bend, discussed elsewhere.

#### Start Mode [0...3]

0: T-only when Triggered  
1: 1-when entering Phase1  
2: 2-when entering Phase2  
3: A-when entering any Phase

Controls how the “Start %” described above is applied to the effect as it is being generated (whether it’s only used when first triggered, or at other times during the Phase Pattern.)

##### 0: T-only when Triggered

The “Start %” is applied only when the effect is triggered, i.e. from the keyboard or through Dynamic MIDI. When other steps of the Phase Pattern are entered during subsequent playback, the Note Series will reset to either the top or bottom depending on the Phase “Direction” setting.

##### 1: 1-when entering Phase1

Each time that playback of a Phase Pattern step containing Phase 1 begins, the “Start %” will be applied. This can be used to start a phase somewhere in the middle of the Note Series from which the indexes can be chosen in either direction according to the Index Pattern.

##### 2: 2-when entering Phase2

Each time that playback of a Phase Pattern step containing Phase 2 begins, the “Start %” will be applied. This can be used to start a phase somewhere in the middle of the Note Series from which the indexes can be chosen in either direction according to the Index Pattern.

##### 3: A-when entering any Phase

Each time that playback of any Phase Pattern step begins, either Phase 1 or Phase 2, the “Start %” will be applied. This can be used to start a phase somewhere

in the middle of the Note Series from which the indexes can be chosen in either direction according to the Index Pattern.

- ⚡ Not available when “GE Type” (☞p.1023) = **1: Generated-Gated**. If **2: Generated-Drum**, the Note Series can be applied as pitch bend, discussed elsewhere.

### Length Mode [0...2]

0: AC-Actual    1: TS-Time Signature    2: EV-Events

Selects one of several modes for determining when a Phase Change from the current step to the next step of the Phase Pattern will occur. Note that this has a certain interaction with the Cycle Mode parameter, described below.

#### 0: AC-Actual

Causes the Phase Change to be completely dependent on the length of the Note Series and the Phase “Beginning/End Offsets.” The portion of the Note Series to be used as specified by the Phase “Beginning/End Offsets” (described below) is referred to as the “playback portion” of the Note Series. The notes are generated by moving through the Note series according to the Index Group settings; when either end of the playback portion has been reached, a Phase Change occurs. Therefore, if more or less notes are played, the Phases will change sooner or later and bear no relation to any time signatures or specific number of events. This is useful for GEs that model the behavior of most simple arpeggiators.

- ⚡ Not available if “GE Type” (☞p.1023) = **1: Generated-Gated**.

#### 1: TS-Time Signature

Makes the Time Signature parameters (“TSig Numerator” and “TSig Denominator” on page 1032) available in the Phase Specific Parameter area of each Phase (described below). These allow setting each Phase to various time signatures, which cause the Phase to playback a certain number of beats regardless of any other circumstances that might trigger a Phase Change. When moving through the Note Series, if either end of the playback portion is reached (specified by the “Phase Beginning/End Offsets” ☞p.1033) before the amount of beats specified has occurred, then the movement either freezes, generates silence, wraps around, or cycles back and continues (depending on the setting of the “Cycle Mode” parameter, described below). Useful for groove generation and constraining effects to certain time signatures.

#### 2: EV-Events

Makes the “Events” parameter available in the Phase Specific Parameter area of each Phase (described below). This is used to set the Phase to perform a certain number of events before changing Phases (an event being a note or cluster). When moving through the Note Series, if either end of the playback portion is reached (specified by the “Phase Beginning/End Offsets” ☞p.1033) before the number of events specified has occurred, then the movement either freezes, generates silence, wraps around, or cycles back and continues (depending on the setting of the “Cycle

Mode” parameter, described below). Useful for constraining effects to a certain number of specific events, such as 4 strums per Phase.

### Cycle Mode [0...3]

- 0: S-replace with silence
- 1: F-fill with top/bottom note
- 2: R-restart at other end of Phase
- 3: W-wrap at either end of Phase
- 4: B-cycle back from beginning of Phase
- 5: E-cycle back from end of Phase
- 6: BE-cycle back from beginning & end of Phase

Determines what will happen when either end of the playback portion of the Phase (specified by the “Phase Beginning/End Offsets” (☞p.1033) and/or the length of the Note Series) is reached during note generation. If the “Length Mode” is **1: TS - Time Signature** or **2: EV - Events**, cycling can be allowed to occur. This has a different effect depending on the setting of the Phase “Length Mode” (above).

- ⚡ Not available if “Phase Length Mode” (above) = **0: Actual**. Not available if “GE Type” = **1: Generated-Gated**, unless “Gate Type” (☞p.1023) = **1: Vel CP**. If “GE Type” = **2: Generated-Drum**, the Note Series can be applied as pitch bend, discussed elsewhere.

#### 0: S-replace with silence

If note generation would extend beyond either end of the playback portion of the Phase, those notes are skipped and replaced with silence. Once the specified number of events (including silent notes) or beats of a time signature are generated, a Phase Change occurs. This can be used to simulate the Triton Arpeggiator setting “Arpeggio Type”: **As Played**.

#### 1: F-fill with top/bottom note

If note generation would extend beyond either end of the playback portion of the Phase, those notes are limited and replaced with the bottom or top note of the Phase. Once the specified number of events or beats of a time signature are generated; a Phase Change occurs. Settings of the Index Pattern or Cluster Pattern which would cause movement beyond that point have no effect. This can be used to simulate the Triton Arpeggiator setting “Arpeggio Type”: **As Played (Fill)**.

#### 2: R-restart at other end of Phase

If note generation would extend beyond either end of the playback portion of the Phase, those notes are replaced by notes within the playback portion, as if the riff restarted at the other end. (For the more technically oriented, the index is kept within range using modulo division.) Once the specified number of events or beats of a time signature are generated, a Phase Change occurs. This can be used to simulate the Triton Arpeggiator setting “Arpeggio Type”: **Running Up**.

#### 3: W-wrap at either end of Phase

If note generation would extend beyond either end of the playback portion of the Phase, those notes are replaced by notes within the playback portion, as if the riff is being “wrapped around” the end point. (For the more technically oriented, the index is kept within range by inverting it.) Once the specified number of events or beats of a time signature are generated, a



Phase Change occurs. This can be used to simulate the Triton Arpeggiator setting “Arpeggio Type”:  
**Up&Down.**

**4: B-cycle back from beginning of Phase**

Allows “cycling” to occur at the beginning of the playback portion of the Phase. For example, if the movement specified by the Index Pattern causes the index to go backwards beyond the beginning of the playback portion, “cycling” will occur (the index will automatically be jumped back into the playback portion by a calculated amount). If the Phase “Length Mode” is **0: AC-Actual**, no cycling is performed and a Phase Change will immediately occur.

**5: E-cycle back from end of Phase**

Allows “cycling” to occur at the end of the playback portion of the Phase. For example, if the movement specified by the Index Pattern causes the index to go forwards beyond end of the playback portion, “cycling” will occur (the index will automatically be jumped back into the playback portion by a calculated amount). If the Phase “Length Mode” is **0: AC-Actual**, no cycling is performed and a Phase Change will immediately occur.

**6: BE-cycle back from beginning & end of Phase**

Allows the behavior described above at both ends of the playback portion of the Phase.

**Phase Specific Parameters**

For each of the two Phases, a group of Phase Specific Parameters allow control of some performance characteristics within each Phase. If settings of the Phase Pattern indicate a particular Phase is not being used, the Phase Specific Parameters for that Phase will not be operable.

**Direction [0, 1]**

0: Forward      1: Backward

Selects the basic direction for movement through the Note Series in a particular phase. Works in conjunction with the parameters in the Index Group, which control how the index(es) move through the Note Series. For example, when the Direction is **0: Forward**, the Index Pattern values are added to the index to move it through the Note Series from left to right; when Direction is **1: Backward**, the Index Pattern values are subtracted to move the index through the Note Series from right to left.

 Not available when “GE Type” (p.1023) = **1: Generated-Gated**. If **2: Generated-Drum**, the Note Series can be applied as pitch bend, discussed elsewhere.

**Phase Transpose [-36...+36 (semitones)]**

Allows each Phase to be transposed individually.

 This applies to each time the Phase occurs in the overall Phase Pattern, unlike the Step Transpose Value. Has no effect on Direct Indexing effects, which have a separate Transpose parameter (see Direct Index Group) or when “GE Type”(p.1023) = **2: Generated-Drum**. The Phase Transpose value is cumulative with the Step Transpose value discussed above. For example, if a Step Transpose Value is **-12**, and the Phase Transpose Value for the Phase in use during that step is **+24**, the overall transpose would be **+12**.

**Octave Phs. Transpose [-36...+36]**

Allows the Phase’s Transpose value to be quantized to the nearest octave, so that when being changed in real-time, only transposition by octaves is possible. In this case, the value of the parameter changes by semitones, but the actual transpose value will only change at certain points within the range:

-36 to -31 = -36 (-3 octaves)  
-30 to -19 = -24 (-2 octaves)

-18 to -7 = -12 (-1 octave)  
-6 to +5 = 0 (no transpose)  
+6 to +17 = +12 (+1 octave)  
+18 to +29 = +24 (+2 octaves)  
+30 to +36 = +36 (+3 octaves)

**Oct/5th Phs. Transpose [-36...+36]**

Allows the Phase’s Transpose value to be quantized to the nearest octave or fifth, so that when being changed in real-time, only transposition by octaves or fifths is possible. In this case, the value of the parameter changes by semitones, but the actual transpose value will only change at certain points within the range:

-36 to -33 = -36 (-3 octaves)  
-32 to -27 = -29 (-3 octaves +5th)  
-26 to -21 = -24 (-2 octaves)  
-20 to -15 = -17 (-2 octaves +5th)  
-14 to -9 = -12 (-1 octave)  
-8 to -3 = -5 (-1 octave +5th)  
-2 to +3 = 0 (no transpose)  
+4 to +9 = +7 (+5th)  
+10 to +15 = +12 (+1 octave)  
+16 to +21 = +19 (+1 octave +5th)  
+22 to +27 = +24 (+2 octaves)  
+28 to +33 = +31 (+2 octaves +5th)  
+34 to +36 = +36 (+3 octaves)

**Events [1...96]**

**TSig Numerator [0...31]**

0...31: 1...32

**TSig Denominator [0...4]**

0: 16      1: 12      2: 8      3: 6      4: 4

The parameters for determining when a Phase Change should occur vary according to the setting of the Phase “Length Mode” (p.1031), described in General Parameters above. When the Phase “Length Mode” is **1: TS-Time Signature**, “TSig Numerator” and “TSig Denominator” are available which allow you to specify various time signatures for each Phase. A certain number of beats is then performed in the Phase, regardless of any other circumstances which might trigger a Phase Change. When the Phase “Length Mode” is **2: EV-Events**, a events is available which allows you to specify a certain number of events (an event being a note or cluster of notes). The specified number of events is then performed in each Phase,

regardless of any other circumstances which might trigger a Phase Change. When the Phase “Length Mode” is **0: AC-Actual**, then these parameters are not available. The Phases will then change according to the movement through the Note Series.

 **0: AC-Actual** not available when GE Type (p.1023) = **1: Generated-Gated**.

**Beginning Offset %** [0...100 (%)]

**End Offset %** [0...100 (%)]

Sets an overall beginning and end range in the Note Series for note generation within the Phase. Even though settings in the Note Series Group may have

created a very long Note Series, these can be used to select just a portion of the Note Series from which to generate notes over the length of a particular Phase.

For example, if the “Beginning Offset” is **25%** and the “End Offset” is **75%**, note generation within the Phase would be restricted to coming from the portion of the Note Series 1/4 to 3/4 of the way from the beginning.

 Not available when “GE Type” (p.1023) = **1: Generated-Gated**, unless “Gate Type” (p.1023) = **1: Vel CP**. If **2: Generated-Drum**, the Note Series can be applied as pitch bend, discussed elsewhere.

## End Loop Parameters

Determines whether a portion of the effect will loop, after a certain number of steps of the Phase Pattern have been completed. Note that once the loop has started, it continues using the Phase Pattern, and current Phase “Length Mode”.

**End Loop On/Off** [0, 1]

0: Off 1: On

Enables/disables this feature, and the following two parameters.

**End Loop Start Step** [1...17]

Selects a total number of Phase Pattern steps to complete before entering the End Loop. For example, if the Phase Pattern was set to a 2 step pattern of {1, 2}

and the Start Step menu to **4**, the loop would be entered after the 2nd time through the Phase Pattern, at the end of the 4th step in total. Not available if the “End Loop On/Off” is set to **0: Off**.

**End Loop Length** [1...96]

1...96: events

Determines how many events (notes or clusters) will be moved forward/backward while looping, according to various other parameters such as the Index Pattern. Not available if the “End Loop On/Off” is set to **0: Off**.

## Pattern Parameters

**Pattern Items** [1...16 (steps)]

Sets the number of steps in the Phase Pattern.

**Pattern Step 1...16** [0, 1]

0: Phase1 1: Phase2

Sets which phase (Phase 1 or Phase 2) will be used for generating data when a specific step of the Phase Pattern is entered during playback. For each step that is enabled, the step may be set to either Phase 1 or Phase 2.

**Note:** If the number of steps in the Phase Pattern (Pattern Items) is less than the step being edited, this will produce no audible results.

**Template Parameters** [0...15]

Selects one of 16 templates (each having 4 steps) that can be applied to all or parts of the Phase Pattern. They specify 16 different combinations of Phase 1 and Phase 2 within a 4 step section:

- |            |             |             |
|------------|-------------|-------------|
| 0: 1-1-1-1 | 6: 1-2-1-1  | 12: 1-2-2-2 |
| 1: 2-2-2-2 | 7: 2-1-1-1  | 13: 2-2-2-1 |
| 2: 1-2-1-2 | 8: 1-1-2-2  | 14: 2-2-1-2 |
| 3: 2-1-2-1 | 9: 1-2-2-1  | 15: 2-1-2-2 |
| 4: 1-1-1-2 | 10: 2-2-1-1 |             |
| 5: 1-1-2-1 | 11: 2-1-1-2 |             |

**Template (All Steps)**

The chosen template is applied to all steps of the Phase Pattern, regardless of how many there are. For example, if you selected **6: 1-2-1-1** (Template 6), then the following would happen to the Phase Pattern:

- If the Phase Pattern had 1 steps: 1
- If the Phase Pattern had 2 steps: 1-2
- If the Phase Pattern had 4 steps: 1-2-1-1
- If the Phase Pattern had 7 steps: 1-2-1-1 1-2-1
- If the Phase Pattern had 16 steps: 1-2-1-1 1-2-1-1 1-2-1-1 1-2-1-1

**Template Steps 1...4**

Applies the selected template only to the first 4 steps of the Phase Pattern.

If there are more steps, they will remain unchanged.

**Template Steps 5...8**

Applies the selected template only to steps 5-8 of the Phase Pattern. If there are more steps, they will remain unchanged. Steps 1-4 will remain unchanged.

**Template Steps 9...12**

Same as above, except for steps 9-12.

**Template Steps 13...16**

Same as above, except for steps 13-16.



Note that if the number of steps in the Phase Pattern (Pattern Items) is less than the steps for which Templates are being changed, these will produce no audible results.

**Step Transpose Value [-48...0...+48]**

Allows a separate Transpose Value to be used in each step of the Phase Pattern (-48...+48 semitones) that affects all notes that are generated during that step.

The Step Transpose Value is cumulative with the Phase Transpose Value discussed below. For example, if a Step Transpose Value is -12, and the Phase Transpose Value for the Phase in use during that step is +24, the overall transpose would be +12. While this value is not directly accessible in each Phase Pattern Step as a GE RT Parameter, it may be set as part of a GE and varied by the following two GE RT Parameters:

**Step Transpose On/Off**

[0, 1]

0: Off 1: On

Allows the effect of the Step Transpose Values in each Phase Pattern Step to be turned on or off for the entire Phase Pattern.

**Step Transp. Template**

[0...17]

Allows one of 18 different templates for the 16 steps of a Phase Pattern to be chosen and applied to the current Phase Pattern. These 18 templates provide a wide variety of switching between octaves in various orders and amounts, and correspond to various settings of the Triton Arpeggiator "Octave" and "Octave Motion" parameters (refer to table at the bottom). They can be used to simulate Triton Arpeggio performances, in addition to other useful applications.

Template for emulating the operation of the TRITON series arpeggiator parameters "Octave" and "Octave Motion"

	1	2	3	4	5	6	7	8	9	10	11	12	13	14	15	16	Octave	Octave Motion*
0:	0	0	0	0	0	0	0	0	0	0	0	0	0	0	0	0	1	U D B
1:	0	12	0	12	0	12	0	12	0	12	0	12	0	12	0	12	2	U B
2:	12	0	12	0	12	0	12	0	12	0	12	0	12	0	12	0	2	D
3:	0	12	24	0	12	24	0	12	24	0	12	24	0	12	24	0	3	U
4:	24	12	0	24	12	0	24	12	0	24	12	0	24	12	0	24	3	D
5:	0	12	24	12	0	12	24	12	0	12	24	12	0	12	24	12	3	B
6:	0	12	24	36	0	12	24	36	0	12	24	36	0	12	24	36	4	U
7:	36	24	12	0	36	24	12	0	36	24	12	0	36	24	12	0	4	D
8:	0	12	24	36	24	12											4	B
9:	0	0	0	0	0	0	0	0	0	0	0	0	0	0	0	0	1	U D B (x2)
10:	0	0	12	12	0	0	12	12	0	0	12	12	0	0	12	12	2	U B (x2)
11:	12	12	0	0	12	12	0	0	12	12	0	0	12	12	0	0	2	D (x2)
12:	0	0	12	12	24	24	0	0	12	12	24	24	0	0	12	12	3	U (x2)
13:	24	24	12	12	0	0	24	24	12	12	0	0	24	24	12	12	3	D (x2)
14:	0	0	12	12	24	24	12	12	0	0	12	12	24	24	12	12	3	B (x2)
15:	0	0	12	12	24	24	36	36	0	0	12	12	24	24	36	36	4	U (x2)
16:	36	36	24	24	12	12	0	0	36	36	24	24	12	12	0	0	4	D (x2)
17:	0	0	12	12	24	24	36	36	24	24	12	12	0	0	12	12	4	B (x2)

\* = Up, D = Down, B = Both

# Rhythm Group

## Overview

The **Rhythm Group** controls the rhythmic characteristics of the Generated Effect. It can also have an influence on when “Auto Bend” pitch bending effects (set up on the Bend Group) are generated.

## About Rhythm Patterns

Rhythm Patterns control the timing with which notes will be generated. A value derived from a Rhythm Pattern is the size of the step between each generated note. Choices can be made from “Random Pools” (p.1037) of values as described in detail later on. Furthermore, values can be tied to each other; the ties can be absolute or random.

Rhythm Patterns may be multiplied by the “Rhythm Multiplier,” which gives them many more variations, in addition to providing easy ways to experiment with

fractal and poly-rhythmic effects. A Rhythm Pattern of {8th, 16th, 16th} with a “Rhythm Multiplier” (p.1038) of 200% will play {Quarter, 8th, 8th}.

A Rhythm Pattern will loop as long as note generation continues. It normally will not reset to the beginning of the Pattern unless a new Trigger is received, or the Phase Pattern has been configured to restart it at the beginning of certain Phases. This means that a four step Rhythm Pattern can be looping while an eight step Velocity Pattern and a twelve step Cluster Pattern are also independently looping, for example.

## Global Parameters

The Global Parameters section contains parameters that relate to shifting the overall timing of the notes that are generated. The Humanize parameter allows subtle randomizations of timing, while the other four Swing-related RT Parameters deal with adding a “swing” or “hip-hop” feel to the rhythms.

The four Swing-related RT parameters will not be available if Swing On/Off is set to “Off.”

### Humanize [0...255 (ms)]

Sets a range in milliseconds within which each note/cluster may be randomly shifted in time. For example, if set to **10 ms**, then each cluster or note as it is generated has a possibility of a random offset in time of between 0 to 10 ms. This affects all of the notes in the cluster at the same time. This can be used to impart a more “human,” less machine-like precision to generated notes. This can also be used to totally destroy the timing!

### Swing Note Value [0...3]

0: 32th note	2: 8th note
1: 16th note	3: 4th note

Selects the base note value to be used in calculating swing. For example, if you want to add a swing feel to a steady string of 16th notes, you would select a **1: 16th note**. Straight 8th notes would exhibit no change with this setting, since they do not swing in such a feel unless they are syncopated. On the other hand, if you swing 16th notes with a **2: 8th note** Swing Note selected, the 16th notes are swung in an 8th note feel. While this is not necessarily natural “swing,” interesting shiftings of timings can be produced. Note that the setting of this parameter can be modified by the “Swing Use Multiplier” parameter, explained below.

### Swing % [-200...200 (%)]

Sets the percentage of swing/hip-hop feeling to be applied. 0% = no swing, 50% = triplets, while 100% pushes the swung notes all the way to the next value of half the note length set by the “Swing Note Value” (p.1035). For example, if swinging straight **1: 16th notes**, 100% would push the swung notes to 32nds. 200% would push the swung notes all the way to the next 16th. **Negative values** push the swung notes the other direction. Note that triplet rhythm values may not be affected by swing, depending on internal settings of the GE.

Triplets may or may not be swung depending on the setting of the “Swing Triplets” parameter below.

### Swing % 0~100,101,102 [0...100, 101, 102]

0...100: 0...+100%
101: 200%
102: -200%

This special variation of the Swing % parameter allows only the most useful settings to be applied as a GE RT Parameter, for assigning to a Real-Time Control. A setting of 0...100 corresponds to 0...100% swing factor, while a value of **101** selects +200%, and a value of **102** selects -200%. Using this ensures that the most useful settings will be available over the widest range of the assigned control, while allowing the useful +/-200% values to still be selected.

### Swing Use Multiplier [0...3]

0: Off	2: P1-Phase1
1: Ind-Independently	3: P2-Phase2

The “Rhythm Multiplier” (explained later on in this chapter) causes the values in the Rhythm Pattern to be increased or decreased by a percentage. The “Swing

Use Multiplier" specifies several options for selectively applying (or not applying) the Rhythm Multiplier(s) to the "Swing Note Value" also, thereby affecting the resulting swing feel.

**0: Off-do not use Multipliers for Swing**

The "Rhythm Multipliers" in each Phase do not have any affect on the "Swing Note Value". For example, if generating 16th notes with a "Rhythm Multiplier" of 100% and "Swing Note Value" set to 1: 16th note, the resulting 16th notes will be swung with a 16th note feel. If the "Rhythm Multiplier" is changed to 50%, the resulting 32nd notes will still be swung with a 16th note feel. If the "Rhythm Multiplier" is changed to 200%, the resulting 8th notes will also be swung with a 16th note feel, resulting in no perceptible swing (unless the rhythm is syncopated).

**1: Ind-independently use each Phase's Multiplier**

Each Phase's "Rhythm Multiplier" (esp.1038) will independently affect swing calculations while generating rhythms within that Phase. In other words, the "Swing Note Value" will also have the "Rhythm Multiplier" applied to it. For example, if generating 16th notes with a "Rhythm Multiplier" of 100% and "Swing Note Value" set to 1: 16th note, the resulting 16th notes will be swung with a 16th note feel. If the "Rhythm Multiplier" is changed to 50%, the resulting 32nd notes will be swung with a 32nd note feel. If the

"Rhythm Multiplier" is changed to 200%, the resulting 8th notes will be swung with an 8th note feel. With this setting, it is possible to swing with different note values in the two Phases, such as swinging with an 8th note feel in one phase and swinging with a 16th note feel in the other.

**2: P1-always use Phase1's Multiplier**

Same as 1: Ind above, except that Phase 1's "Rhythm Multiplier" will always be used, regardless of which Phase is currently generating rhythms. This allows the Rhythm Multiplier to be varied in Phase 1 while affecting the overall swing settings for the whole effect. For example, if generating 16th notes in both phases with both Phase's "Rhythm Multipliers" set to 100% and "Swing Note Value" set to 1: 16th note, the resulting 16th notes will be swung with a 16th note feel. If Phase 1's "Rhythm Multiplier" is changed to 200%, the resulting 8th notes in Phase 1 and 16th notes in Phase 2 will all be swung with an 8th note feel. If the "Rhythm Multiplier" in Phase 1 is 100% and changed to 50% in Phase 2, the resulting 16th notes in Phase 1 and 32nd notes in Phase 2 will all be swung with a 16th note feel.

**3: P2-always use Phase2's Multiplier**

Same as 2: P1 described above, except utilizing Phase 2's "Rhythm Multiplier."

**Pattern Grid & Associated Parameters**

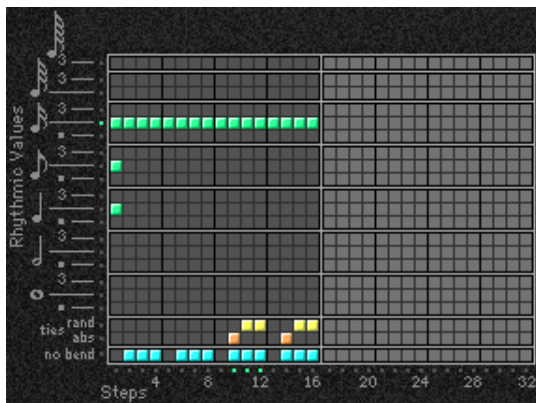

**Rhythm Pattern**

A Rhythm Pattern controls the rhythm that the notes are generated with according to a grid of rhythmic values. It has any number of steps up to 32, with each step being represented by one column on the grid. The first column always contains at least one value; unused columns appear disabled. The top part of the grid corresponds to 18 different rhythmic values; the bottom 3 rows are special purpose rows:

[ties: rand] - Random Tie: randomly ties the rhythmic value in the same column to the previous column's rhythmic value. For example, a 16th note in the first column followed by a 16th note and a random tie in the 2nd column yields either an 8th note or two 16th notes. When at least one random tie has been selected, a

weighting curve is available which allows choices to be slanted towards more ties or less ties, as described later.

[ties: abs] - Absolute Tie: always ties the rhythmic value in same column to the previous column's rhythmic value. For example, a 16th note in the first column followed by a 16th note and an absolute tie in the 2nd column yields an 8th note. The 2 tie rows are mutually exclusive; only one at a time can be used in any given column.

[no bend] - No Bend: affects when Automatic Pitch Bending effects can occur, as set up in the Bend Group. These effects will normally be triggered with every single generated note or cluster; by using the "no bend" row, bends can be prevented from occurring on various steps of the Rhythm Pattern.

⚠ Pattern grids cannot be viewed or edited on the KRONOS.

## Random Weighting Parameters - Pools

The Random Weighting Parameters - Pools are made available when at least one step (column) in the Rhythm Pattern has multiple rhythmic values selected (constituting a “random pool” of values).

Whenever a random pool is encountered in playing through the pattern, a random choice is made from the values in that step. Certain areas of the random pool can be favored by the use of a weighting table, with various shaped curves. Using the curves, you can influence certain choices to be made more or less often than others, allowing very musical real-time control of the randomness.

Whether or not a certain random sequence will repeat for a number of times is controlled by settings in the Phase Pattern.



### Pools-Random Factor [-99...+99]

Controls the degree of slope to the Weighting Curve. 0 = a Linear Curve with any Weighting Curve. **Negative values** not only invert but rotate the curve. When the value is either +99 or -99, the choices are “locked” to the highest or lowest values in the columns, and there are no random choices at all. (The only exception to this is an S-shaped curve with a value of -99. In this case, a random choice will be made between the highest and lowest values only.) For more information, see “Random Weighting Curves” on page 1086.

### Pools-Weighting Curve [0...3]

- 0: Exponential      2: Exp-S
- 1: Logarithmic      3: Log-S

4 different shapes are available, which act to favor certain areas of the pool over others when each random choice is made. For more information, see “Random Weighting Curves” on page 1086.

#### 0: Exponential

With a **positive Factor (+)**, choices will be exponentially weighted towards the shorter rhythms. With a **negative Factor (-)**, choices will be exponentially weighted towards the longer rhythms.

#### 1: Logarithmic

With a **positive Factor (+)**, choices will be logarithmically weighted towards the shorter rhythms. With a **negative Factor (-)**, choices will be logarithmically weighted towards the longer rhythms.

#### 2: Exp-S (Exponential S)

With a **positive Factor (+)**, choices will be exponentially weighted towards the middle rhythms, and away from the shorter and longer rhythms. With a **negative Factor (-)**, choices will be exponentially weighted towards the shorter and longer rhythms, and away from the middle rhythms.

#### 3: Log-S (Logarithmic S)

With a **positive Factor (+)**, choices will be logarithmically weighted towards the middle rhythms, and away from the shorter and longer rhythms. With a **negative Factor (-)**, choices will be logarithmically weighted towards the shorter and longer rhythms, and away from the middle rhythms.

⚡ A Factor of 0 with any shaped curve yields a linear table (straight diagonal line), and each of the values in the pool will have an equal chance of being chosen.

**Note:** While exponential and logarithmic curves may seem to have a similar shape, they have slight differences which can affect the outcome of the random choices. For more information, see “Random Weighting Curves” on page 1086.

The following table summarizes the effect of the various Weighting Curves and the Factor field on the choices from the Rhythm Pools:

Rhythm Pool values that receive priority:		
Weighting Curve	Factor	
	+ (positive)	- (negative)
Exp/Log	longer	shorter
Exp-S/Log-S	middle	shorter/longer

## Random Weighting Parameters - Ties

The Random Weighting Parameters - Ties are made available when at least one step in the Rhythm Pattern contains a Random Tie. Whenever this step is encountered in playing through the pattern and a random choice must be made, the likelihood of a tie occurring can be favored by the use of a weighting table.



### Ties-Random Factor [-99...+99]

Controls the degree of slope to the Weighting Curve. 0 = a Linear Curve with any Weighting Curve. Negative values not only invert but rotate the curve. When the value is +99, the choices are "locked" to no ties whatsoever; when the value is -99, the choices are "locked" to ties always (and the effect is the same as if absolute ties were selected). For more information, see "Random Weighting Curves" on page 1086.

### Ties-Weighting Curve [0, 1]

0: Exponential    1: Logarithmic

2 different shapes are available, which affect the likelihood of a tie occurring when a random choice is made. For more information, see "Random Weighting Curves" on page 1086.

### 0: Exponential

With a **positive Factor (+)**, choices will be exponentially weighted towards rhythm values more often. With a **negative Factor (-)**, choices will be exponentially weighted towards ties more often.

### 1: Logarithmic

With a **positive Factor (+)**, choices will be logarithmically weighted towards the rhythm values more often. With a **negative Factor (-)**, choices will be logarithmically weighted towards the ties more often.

**Note:** While exponential and logarithmic curves may seem to have a similar shape, they have slight differences which can affect the outcome of the random choices. For more information, see "Random Weighting Curves" on page 1086.

A Factor of 0 with any shaped curve yields a linear table (straight diagonal line), and a random tie or a rhythm value in the pool will have an equal chance of getting chosen.

The following table summarizes the effect of the various Weighting Curves and the Factor field on random ties:

Values that receive priority:		
Weighting Curve	Factor	
	+ (positive)	- (negative)
Exp/Log	less ties	more ties

## Associated Parameters

### Rhythm Multiplier [1...800 (%)]

Multiplies the selected Rhythm Pattern by the percentage. Useful for poly-rhythmic and fractal effects, such as using the same Rhythm Pattern at different multiplications. For example, if a Pattern is {16th, 8th, 8th}, then using a "Rhythm Multiplier" of 50% changes it to {32nd, 16th, 16th}; using a "Multiplier" of 200% changes it to {8th, Quarter, Quarter}; using a "Multiplier" of 136% changes it to {8th triplet, Qtr triplet, Qtr triplet}; and using a "Multiplier" of 150% changes it to {dotted 8th, dotted Qtr, dotted Qtr}.

### Straight Multipliers [0...5]

0: 25%    2: 100%    4: 400%  
1: 50%    3: 200%    5: 800%

Selects from a quantized set of "straight" values for the Rhythm Multiplier field. In other words, when applied to a Rhythm Pattern containing values such as 16th notes, the resulting rhythmic values will be straight values such as 8th notes, quarter notes, etc.

### Straight/Trip Mults [0...10]

0: 25%    4: 100%    8: 400%  
1: 34%    5: 136%    9: 544%  
2: 50%    6: 200%    10: 800%  
3: 68%    7: 272%

Selects from a quantized set of "straight & triplet" values for the Rhythm Multiplier field. In other words, when applied to a Rhythm Pattern containing values such as 16th notes, the resulting rhythmic values will be straight values such as 8th notes, quarter notes, etc. or various triplet values.

### Strt/Dot/Trip Mults [0...15]

0: 25%    4: 68%    8: 150%    12: 400%  
1: 34%    5: 75%    9: 200%    13: 544%  
2: 37%    6: 100%    10: 272%    14: 600%  
3: 50%    7: 136%    11: 300%    15: 800%

Selects from a quantized set of "straight, triplet & dotted" values for the Rhythm Multiplier field. In other words, when applied to a Rhythm Pattern containing values such as 16th notes, the resulting

rhythmic values will be straight values such as 8th notes, quarter notes, etc., various triplet values, or various dotted values.

### **Template Parameters**

The two Template Parameters select from 63 or 64 different Rhythm Pattern Templates, and load the parameters into the current Phase's Pattern Grid and associated parameters.

A Rhythm Pattern Template consists of:

- the configuration of the Rhythm Pattern Grid
- Random Weighting Parameters - Pools
- Random Weighting Parameters - Ties

### **Template [1...63]**

The internal settings of the GE for the set of parameters corresponding to the chosen Template are never used; rather they are always replaced by one of the selected Templates from within the Min/Max range specified for the GE Real-Time Parameters page ("MIN (Min Value)" and "MAX (Max Value)"). In this case, available range is 1–63.

### **Template + Restore [0: [As Stored]...63]**

Similar to the above setting; however, the internal settings of the GE can be restored and used as part of the real-time Template operation. In this case, the Min setting of the Template Range actually does not select that Template; rather, it causes the internal settings of the GE to be restored for that Template's set of parameters. In other words, you can have a complex pattern already set up. When "Template + Restore" is being assigned as a GE Real-Time Parameter, you specify a range where the "Min Value" restores the internal settings, and the rest of the range selects Templates, replacing the internal settings. So if the "Min value" was 5 and the "Max value" was 10, choosing 5 would restore the internal settings, and 6 through 10 would select the corresponding Rhythm Template. You can use this to keep the internal settings of the GE, while still allowing a wide variety of Templates to be substituted for various groups of parameters. In this case, the available range is 0–63. You can assign the full range of all 63 Templates, or only a portion of the range, and still have the ability to restore the original internal settings.



## Duration Group

### Overview

The **Duration Group** contains the parameters that control the duration of the notes in a Generated Effect.

### About Duration Patterns

Duration Patterns control the duration of notes for each “rhythm event” that is generated according to the settings in the Rhythm Group. Choices can be made from “Random Pools” of values as described in detail later on. Furthermore, values can be tied to each other; such ties can be absolute or random.

A Duration Pattern will loop as long as note generation continues. It normally will not reset to the beginning of the Pattern unless a new Trigger is received, or the Phase Pattern has been configured to restart it at the beginning of certain Phases. That means that a four step Duration Pattern can be looping while an eight step Velocity Pattern and a twelve step Cluster Pattern are also independently looping, for example.

### Pattern Grid & Associated Parameters

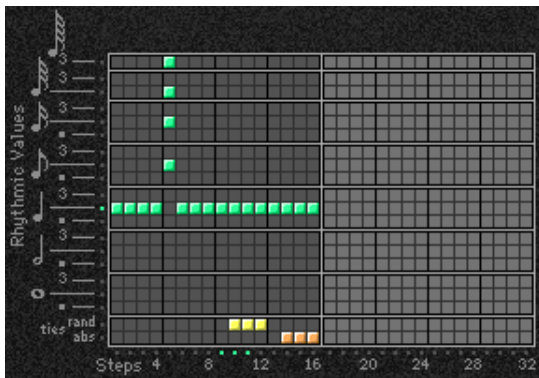

#### Duration Pattern

A Duration Pattern controls the durations that the notes are generated with according to a grid of rhythmic values. It has any number of steps up to 32, with each step being represented by one column on the grid. The first column always contains at least one value; unused columns appear disabled. The top part of the grid corresponds to 18 different rhythmic values; the bottom 2 rows are special purpose rows:

**[ties: rand]** - Random Tie: randomly ties the rhythmic value in the same column to the previous column’s rhythmic value. For example, a 16th note in the first column followed by a 16th note and a random tie in the 2nd column yields either an 8th note or two 16th notes. When at least one random tie has been selected, a weighting curve is available which allows choices to be slanted towards more ties or less ties, as described later.

**[ties: abs]** - Absolute Tie: always ties the rhythmic value in same column to the previous column’s rhythmic value. For example, a 16th note in the first column followed by a 16th note and an absolute tie in the 2nd column yields an 8th note.

The 2 tie rows are mutually exclusive; only one at a time can be used in any given column.

- 🔧 If the “Duration Mode” is **3: Timed**, **4: Rhythm Overlap**, or **5: Rhythm %**, the Duration Pattern Grid is not utilized.
- 🔧 Pattern grids cannot be viewed and edited in the KRONOS.

### Associated Parameters

#### Duration Mode

[0...7]

- |                       |                    |
|-----------------------|--------------------|
| 0: Poly Extend        | 4: Rhythm Overlap  |
| 1: Poly Extend/Damped | 5: Rhythm %        |
| 2: Mono Extend        | 6: Pattern Overlap |
| 3: Timed              | 7: Pattern %       |

Selects one of several modes of operation for generating durations in the current Phase:

- 🔧 Based on the current setting, the Duration Pattern Grid, and Random Weighting Parameters may not be available.

#### 0: Poly Extend

Each note will sustain until the next generation of the same note, or until that note is no longer a part of the Note Series (caused by playing a new chord, for example). For example, if the notes to a CMaj chord are sustaining and the chord is changed to a C Minor, only the Es will be damped. Especially useful for finger-picked and strummed guitar effects. Certain steps may be “damped” by using the Duration Pattern to indicate a duration value shorter than the current Rhythm Pattern value. The “Duration Value” parameter is used to specify a percentage of the Duration Pattern value, making it shorter or longer by a certain amount. For example, if the Rhythm Pattern is generating quarter



notes, any step in the Duration Pattern (as modified by the Duration Value) that is shorter than a quarter note will cause the notes (and all sustaining notes at that time) to have the specified duration. This is useful for simulating the technique of strumming and damping certain chords within the progression. Any value in a Duration Pattern step (as modified by the Duration Value) that is longer than the current Rhythm Pattern value will be ignored, and the notes will sustain as described above. The “Duration Value” specifies a percentage of the overall value (1 – 800%) - therefore, values less than 100% will shorten the duration represented by the Pattern Step, and values greater than 100% will lengthen it.

### 1: Poly Extend/Damped

The same as above, except all sustaining notes will be damped when the chord changes, not just notes that are no longer in the Note Series.

### 2: Mono Extend

The same as above, except each note or cluster is sustained until the next note or cluster (of any pitch or pitches) is generated.

### 3: Timed (“Duration Value”: 1...5000 ms)

The “Duration Value” parameter is used to specify the duration of the generated notes, in milliseconds (1 – 5000 ms). All notes will therefore have the same length. Note that this is independent of the current tempo - if it is set to **50 ms**, it will always be 50 ms, regardless of tempo.

### 4: Rhythm Overlap

(“Duration Value”: -500...+500 ms)

The “Duration Value” parameter is used to specify an amount by which each note or cluster will overlap or be separated from the next note or cluster, in milliseconds (-500 – 500 ms). Note that this relates to the Rhythm Pattern values. **Positive values** cause overlapping; **negative values** cause separation. For example, a setting of **-20** ensures that all notes will extend and be separated from the next notes by 20 ms regardless of the actual rhythm the notes are generated with, or the current tempo. Note that while the Rhythm Pattern values themselves are relative to tempo, the value specified here is not. Using the example setting of **-20**, there will always be a gap of 20 ms between notes regardless of the tempo.

### 5: Rhythm % (“Duration Value”: 1...800%)

The “Duration Value” parameter is used to specify a percentage of the rhythmic value a note is generated with to use as a duration (1 – 800%). Note that this relates to the Rhythm Pattern values. The actual time is then calculated on the fly, taking into account the current tempo. For example, with a setting of **50%**, if the Rhythm Pattern specifies a string of **8th notes**, they will appear to be generated as a string of **16th notes** separated by **16th note rests** (each 8th note will have the duration of a 16th note, or 50%). Note that this value is therefore relative to tempo.

### 6: Pattern Overlap

(“Duration Value”: -500...+500 ms)

The Duration Pattern is used to construct a Duration Pattern, in a similar fashion to the Rhythm Pattern. Each step in the pattern indicates the duration for notes

that are currently to be generated. The “Duration Value” parameter is used to specify amount by which to increase or decrease the pattern values, in milliseconds (-500 – 500 ms). This can be used to set up a certain Duration Pattern, and then vary in real-time the “gate-time” of each note in the pattern simultaneously. For example, if the Duration Pattern is generating **16th - 8th** at a tempo of **120 BPM**, the notes would have the durations of **125 ms, 250 ms**, etc. If the “Duration Value” parameter, is **-20**, they would be generated as **105 ms, 230 ms**, etc. Note that while the Duration Pattern values themselves are relative to tempo, the value specified here is not. Using the example setting of **-20**, the notes will always be **20 ms** shorter regardless of the tempo.

### 7: Pattern % (“Duration Value”: 1...800%)

The Duration Pattern is used to construct a Duration Pattern, in a similar fashion to the Rhythm Pattern. Each step in the pattern indicates the duration for notes that are currently to be generated. The “Duration Value” parameter is used to specify a percentage by which to increase or decrease the pattern values (1 – 800%). This can be also be used to set up a certain Duration Pattern, and then vary in real-time the “gate-time” of each note in the pattern simultaneously, similar to the previous option. For example, if the Duration Pattern is generating **16th - 8th** at a tempo of **120 BPM**, the notes would have the durations of **125 ms, 250 ms**, etc. If the “Duration Value” is **80%**, they would be generated as **100 ms, 200 ms**, etc. Note that this value is therefore

### Duration Value [-500...+5000]

The range and function of this parameter depend on the setting of “Duration Mode.”

See the descriptions above under “Duration Mode.” When the “Duration Mode” is changed, this value will be set to a default value appropriate for the mode. (if it is out of range.)

⚠ Not available if “Duration Mode” = **0: Poly Extend, 1: Poly Extend/Damped, or 2: Mono Extend.**

### Use Rhythm Multiplier [0, 1]

0: Off                      1: On

When **1: On**, the durations of the generated notes will be affected by the current setting of the Rhythm Group “Rhythm Multiplier” (p.1038). For example, if the Duration Pattern specifies a duration of a 16th note, and the “Rhythm Multiplier” is set to **200%** in the current Phase, the actual resulting duration will be an 8th note. This is useful when you want to vary the Rhythm Multiplier in real-time and have the Duration Pattern also lengthen the notes appropriately.

## Random Weighting Parameters - Pools

The Random Weighting Parameters - Pools are made available when at least one step (column) in the Duration Pattern has multiple rhythmic values selected (constituting a “random pool” of values).

For more information, see “Random Weighting Parameters - Pools” on page 1037.

### Pools-Random Factor [-99...+99]

For more information, see “Pools-Random Factor” on page 1037.

### Pools-Weighting Curve [0...3]

0: Exponential      2: Exp-S  
1: Logarithmic      3: Log-S

For more information, see “Pools-Weighting Curve” on page 1037.

The following table summarizes the effect of the various Weighting Curves and the Factor field on the choices from the Duration Pools:

Duration Pool values that receive priority		
Weighting Curve	Factor	
	+ (positive)	- (negative)
Exp/Log	Longer	shorter
Exp-S/Log-S	middle	shorter/longer

## Random Weighting Parameters – Ties

For more information, see “Random Weighting Parameters - Ties” on page 1038.

### Ties-Random Factor [-99...+99]

For more information, see “Ties-Random Factor” on page 1038.

### Ties-Weighting Curve [0, 1]

0: Exponential      1: Logarithmic

For more information, see “Ties-Weighting Curve” on page 1038.

The following table summarizes the effect of the various Weighting Curves and the Factor field on random ties:

Values that receive priority		
Weighting Curve	Factor	
	+ (positive)	- (negative)
Exp/Log	less ties	more ties

## Associated Parameters

### Template Parameters

The two Template Parameters select from 63 or 64 different Duration Pattern Templates, and load the parameters into the current Phase’s Pattern Grid and associated parameters.

A Duration Pattern Template consists of:

- the configuration of the Duration Pattern Grid
- Random Weighting Parameters - Pools
- Random Weighting Parameters - Ties

### Template [1...63]

See “Template” on page 1039, “Rhythm Group” on page 1035 “Template Parameters” on page 1039.

### Template + Restore [0: [As Stored]...63]

☞p.1039 “Rhythm Group”: “Template + Restore”.

## Index Group

### Overview

The **Index Group** controls the order of the pitches as they are generated from the Note Series, and some other characteristics that can affect the number of notes generated at a time.

### About Index Patterns

Index Patterns describe a way of moving through the Note Series in memory and consequently control the order of the pitches as they are generated. The Note Series has an index associated with it that indicates the current position, and the next Index to be generated. The Index Pattern values indicate how the index will be moved after generating the Index at the current position. A positive value moves forward from the current position; a negative value moves backwards; a value of 0 repeats a Index. Choices can be made from "Random Pools" of values as described in detail later on. When the Phase "Direction" is set to **1: Backwards**, the values operate in inverted fashion.

Since the first value in the Index Pattern is not used until after the first Index has been generated, a Index Pattern of {**1, 1, 1, -2**} will cause the generation of the first four notes in the Notes Series, after which it jumps back to the 2nd note in the Note Series and so on.

```
Note Series:   C4 → E4 → G4 → B4 ...
Index Pattern: → 1 → 1 → 1 →
                ← ← -2 ← ←
Generated Note: C4 → E4 → G4 → B4 → E4 ...
```

Note that it is possible to create Index Patterns that will not move ahead or will actually move backwards, given that you can start from a position that is somewhere in the middle of a Note Series by using either the "Start %" (p.1030) or "Beginning/End Offset %" parameters (p.1033) in the Phase Group. If you do create a Index Pattern that simply stays in one place (i.e. {**1, -1**}, or {**0**}), a Phase Change will only occur if the Phase "Length Mode" (p.1031) is not set to **0: AC-Actual**, since in this mode it waits for the end of the Note Series to be reached, and this will never happen if there is no forward movement.

A Index Pattern will loop as long as note generation continues. It normally will not reset to the beginning of the Pattern unless a new Trigger is received, or the Phase Pattern has been configured to restart it at the beginning of certain Phases. This means that a four step Index Pattern can be looping while an eight step Velocity Pattern and a twelve step Cluster Pattern are also independently looping, for example.

Besides using Index Patterns, several other means of moving through the Note Series are provided. These options are controlled with the Index Pattern Type parameter, as described below.

### Pattern Grid & Associated Parameters

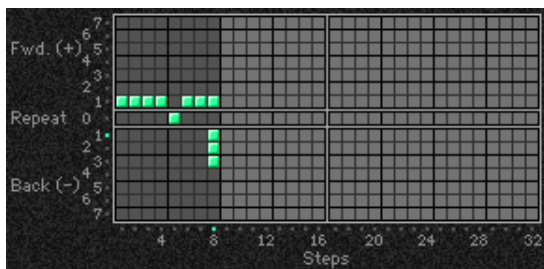

#### Index Pattern

A Index Pattern has any number of steps up to 32, with each step being represented by one column on the grid. The first column always contains at least one value; unused columns appear disabled. The 15 rows represent forward and backward movement from the current index as each note or cluster of notes is generated.

 Pattern grids cannot be viewed or edited on the KRONOS.

### Associated Parameters

#### Index Mode

[0...2]

0: Pattern      1: Random      2: Random Walk

#### 0: Pattern

Movement through the Note Series will be controlled by a Index Pattern constructed in the pattern grid.

#### 1: Random

Causes the pitches to be chosen at random from the applicable portion of the Note Series. Unlike most arpeggiators, the random algorithm used here does not allow notes to happen twice in a row, which sounds less machine-like and more musical. Once a note has been chosen, future choices of that note will not occur until all other notes in the applicable portion have been chosen.

**2: Random Walk** (“Random Walk Max Step”: 1...9)  
 Makes available the “Random Walk Max Step” parameter.

Causes the pitches to meander from the start pitch in a random fashion, with the largest step that can be taken in any direction controlled by the “Random Walk Max Step” parameter. For example, if “Random Walk Max Step” is set to 2, then the “pool” of possible choices for movement from the current Index is {-2, -1, 1, 2}. Note that {0} is not allowed as a possible choice. This is good for creating riffs which sound a bit like improvisation, especially when you use the Phase Group to ensure that random phrases will be repeated a number of times before new ones are chosen.

 If you want the possibility of the same notes happening twice or more in a row, you can use 0: Pattern, and configure the Index Pattern to have pools of values including “0,” instead of using Random or Random Walk.

**Random Walk Max Step [1...9]**

Sets the largest step that can be taken when Index Pattern Type is set to **2: Random Walk**, as described above. The value relates to movement of the Index through the Note Series, not a particular musical interval.

 Not available unless Index “Pattern Type” is **2: Random Walk**.

## Random Weighting Parameters

The Random Weighting Parameters are made available when at least one step in the Index Pattern has multiple values selected (constituting a “random pool” of values).

 p.1037 “Rhythm Group”: “Random Weighting Parameters - Pools”.

**Pools-Random Factor [-99...+99]**

 p.1038 “Rhythm Group”: “Pools-Random Factor”.

**Pools-Weighting Curve [0...3]**

- 0: Exponential      2: Exp-S
- 1: Logarithmic    3: Log-S

For more information, see “Rhythm Group” on page 1035, “Pools-Weighting Curve” on page 1037, and “Random Weighting Curves” on page 1086.

The following table summarizes the effect of the various Weighting Curves and the Factor field on the choices from the Index Pattern Pools:

Index Pool values that receive priority:		
Weighting Curve	Factor	
	+ (positive)	- (negative)
Exp/Log	higher in grid	lower in grid
Exp-S/Log-S	middle	higher/lower

## Associated Parameters

**Cluster Mode [0, 1]**

Sets the way that clusters affect the advancement through the Index Pattern. When set to Multi, a cluster will advance by as many steps as notes in the cluster, depending on other internal settings.

- 0: Single      1: Multi

**0: Single-1 Step per Cluster**

Each time a note, cluster of notes, or group of drum notes is generated one Index Pattern Value will be chosen for the resulting note or cluster of notes, after which the Index Pattern advances to the next value. For example, a cluster of six notes will all be generated from the next six adjacent notes in the Note Series (or Drum Pattern) and advance the pattern by one to the next step. In other words, when a cluster is about to be generated, the index in the Note Series will first move an amount determined by the previous Step’s Index Pattern Value; then all the notes in the cluster will be generated from adjacent indexes, after which the Pattern will again advance by one. This is useful for creating clusters of notes which jump around following the Index Pattern exactly; the bottom note of each cluster essentially follows the path that would be taken by a cluster size of 1, with the effect that cluster size has no effect on how quickly the Index Pattern

moves through the Note Series and Phase (or Drum Pattern). Also useful for randomizing Drum Patterns, since it will cause the index into the Drum Pattern to jump around and not move forward in a linear fashion.

Index Pattern= 2, Cluster Size = 6

Note    C2 E2 G2 B2 C3 E3 G3 B3 C4 E4 G4 B4  
 Series:  
 Step1:    C2 E2 G2 B2 C3 E3  
 Step2:            G2 B2 C3 E3 G3 B3  
 Step3:                    C3 E3 G3 B3 C4 E4  
 Step4:                            G3 B3 C4 E4 G4 B4

**1: Multi-1 Step For Each Note In Cluster**

When the internal GE parameter “Advance Mode” is **0: Independent**: For every note in a cluster or group of drum notes generated simultaneously, a separate Index Pattern Value will be chosen after which the Index Pattern advances to the next value. For example, a cluster of six notes will be generated with the next six Index Pattern Values (with a net advance of six steps). This means that each note in the cluster will not necessarily be the adjacent note in the Note Series (or Drum Pattern), but a certain distance from the previous note as specified by the pattern value. This is useful for creating clusters of notes with different

voicings, or randomizing Drum Patterns in a manner different than above. Another effect of this is that after each cluster, the next cluster starts where the previous cluster left off, in effect advancing through the Phase and the Note Series (or Drum Pattern) much more quickly.

Index Pattern= 2, Cluster Size = 6

Note C E G B C E G B C E G B C E G B ...  
 Series: 2 2 2 2 3 3 3 3 4 4 4 4 5 5 5 5 6 6 6 6 ...  
 Step1: C G C **G** C G  
 2 2 3 **3** 4 4  
 Step2: C G C G  
 5 5 6 6 ...

When the internal GE parameter "Advance Mode" is 1: Lock (R) or one of the Drum Lock options:

The Index Pattern is using the other pattern's index; therefore, it is not possible for it to advance with each note. So it works slightly differently: the Index Value at the current step is used for each note in the cluster. So a cluster of six notes will be generated with the same distance between each index, as specified by the current Index Pattern Value. This value also indicates where the next cluster will start. For example, with an Index Pattern value of {3}, a cluster of 3 notes will have the indexes spaced by 3 and the next cluster will start 3 indexes away from the last generated note.

Index Pattern = {3 2 1}, Cluster Size = 3

Advance Mode: Lock (R), Cluster Mode: Multi

Note **C E G B C E G B C E G B C E G B** ...  
 Series: **2 2 2 2 3 3 3 3 4 4 4 4 5 5 5 5 6 6 6 6** ...  
 Step1: C B **G**  
 2 2 **3**  
 Step2: E2 **B** E  
 4 5  
 Step3: B C E ...  
 5 6 6

⚠ When the "GE Type" (p.1023) is **0: Generated - Riff**, setting this to **1: Multi** will have no effect unless there is a Cluster Pattern containing values of more than just 1.

⚠ When the "GE Type" is **2: Generated-Drum**, setting this to **1: Multi** will have no effect unless at least one Drum Pattern has the "[c] (clusters)" button turned on in the Phase Pattern and there is a Cluster Pattern containing values of more than just 1.

**Invert** [0, 1]

0: Off 1: On

When **1: On**, the index will be inverted with regards to the overall Note Series (taking into consideration the "Beginning and End Offsets" in the Phase Group) and generated again, thereby generating twice as many notes at a time. This will also cause any clusters to be inverted.

**0: Off**

Index Pattern= 2, Cluster Size= 2

Note C2 E2 G2 B2 C3 E3 G3 B3  
 Series:  
 Step1: C2 E2

Step2: G2 B2  
 Step3: C3 E3  
 Step4: G3 B3

**1: On**

Index Pattern= 2, Cluster Size= 2

Note C2 E2 G2 B2 C3 E3 G3 B3  
 Series:  
 Step1: C2 E2 G3 B3  
 Step2: G2 B2 C3 E3  
 Step3: G2 B2 C3 E3  
 Step4: C2 E2 G3 B3

**Double**

[0, 1]

0: Off 1: On

When **1: On**, the "Double Amount" parameter becomes available, and the index will be doubled by the interval indicated and generated again, thereby generating twice as many notes at a time. This will also cause any clusters to be doubled.

**Note:** When using "Double" and "Invert" at the same time, four times as many notes will be generated.

**Double Amount**

[0...12]

0: Auto 1...12: Index

This parameter becomes available when "Double" is **1: On**. The index will be doubled by the interval indicated and generated again, thereby generating twice as many notes at a time. When set to **0: Auto**, an optimal interval is automatically calculated depending on the number of notes in the Note Series. The other settings specify exact distances from the current index (forward) within the Note Series (not semitones).

"Double": **1: On**, "Double Amount": **2**

Note C2 E2 G2 B2 C3 E3 G3 B3 C4 E4 G4 B4  
 Series:  
 Step1: C2 G2  
 Step2: E2 B2  
 Step3: G2 C3  
 Step4: B2 E3

**Inv/Dbl Vel. Offset**

[0...200%]

Sets an amount by which the velocity of any inverted and doubled notes will be offset from the original notes. This allows you to make them a bit softer or louder than the original notes. The value is a percentage of the original note's velocity, so values **less than 100** will produce softer inverted and doubled notes, while values **greater than 100** will produce louder inverted and doubled notes. A value of **0%** will effectively stop the generation of inverted and doubled notes.

⚠ Not available unless "Double" or "Invert" (p.1045) is set to **1: On**.

**Template Parameters**

The two Template Parameters select from 63 or 64 different Index Pattern Templates, and load the parameters into the current Phase's Pattern Grid and associated parameters.

An Index Pattern Template consists of:

- the configuration of the Index Pattern Grid
- Random Weighting Parameters

**Template** [1...63]

☞ p.1039 "Rhythm Group": "Template".

**Template + Restore** [0: [As Stored]...63]

☞ p.1039 "Rhythm Group": "Template + Restore".



## Cluster Group

### Overview

The Cluster Group contains the parameters that control the “clustering” characteristics of the Generated Effect (the number of notes to generate simultaneously each time a rhythm event occurs,

thereby creating chords and polyphonic phrases). Also controlled from here is the degree of strumming on a cluster, and the direction in which a cluster is strummed.

### About Cluster Patterns

A “cluster” is a group of notes that will be generated at the same time, with a size ranging from 1 to 10. Cluster Patterns control how many notes at a time will be generated each time the Rhythm Pattern determines that it is time to produce some notes (each “rhythm event”). This can be used to cause chords to be generated at certain times; the resulting chords may optionally strummed or skewed in several ways, with differing degrees of looseness. Random choices of cluster sizes can be made from “Random Pools” of values as described in detail later on.

If the Cluster Pattern is 1, then single notes are produced (when “GE Type” (p.1023) = 0: **Generated-Riff**). A CMaj7 as input source material might produce the following Riff:

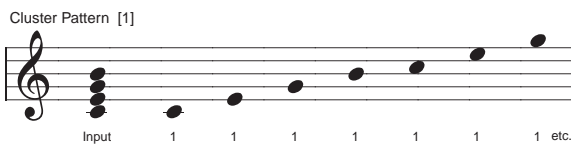

If the Cluster Pattern was {3, 1, 1, 3, 1, 2} (and the Index Pattern “Cluster Mode” 0: **Single** (p.1044)), then the following result would be produced by the same input notes:



Note that the number of notes in a cluster can be effectively doubled or quadrupled if “Invert,” “Double” (p.1045) or both are being used in the Index Group.

A Cluster Pattern will loop as long as note generation continues. It normally will not reset to the beginning of the Pattern unless a new Trigger is received, or unless the Phase Pattern has been configured to restart it at the beginning of certain Phases. This means that a four step Rhythm Pattern can be looping while an eight step Velocity Pattern and a twelve step Cluster Pattern are also independently looping, for example.

#### Strum [0...1000 (ms)]

Sets the value in milliseconds that each cluster will be “strummed” (quickly arpeggiated or flammed). Note that a single note cannot be strummed, so this only has an effect on cluster sizes greater than 1. This is the total time for each cluster, so each note in a cluster of 5 notes will be closer together than a cluster of 3 notes with the same strum value. This maintains a proper degree of “looseness” while changing cluster sizes.

Strums are presently alternated in the up and down direction. By setting this to high values (so there are not really strums, but arpeggiations happening), interesting overlappings of each cluster over subsequent clusters can be made to occur.

- ⚠ Not available if “GE Type” (p.1023) = 2: **Generated-Drum**. Not available if “GE Type” = 1: **Generated-Gated** and “Gate Type” = **Expression**.

### Pattern Grid & Associated Parameters

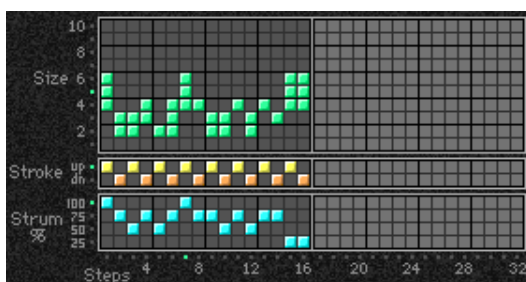

#### Cluster Pattern

A Cluster Pattern represents a series of values indicating the size of clusters of notes to be generated (chords). It has any number of steps up to 32, with each

step being represented by one column on the grid. The first column always contains at least one value; unused columns appear disabled. The 10 rows represent the number of notes to be generated at a time, from 1 to 10.

- ⚠ Pattern grids cannot be viewed or edited on the KRONOS.



## Random Weighting Parameters

The Random Weighting Parameters are made available when at least one step (column) in the Cluster Pattern has multiple values selected (constituting a “random pool” of values).

For more information, see “Rhythm Group” on page 1035, and “Random Weighting Parameters - Pools” on page 1037.

### Pools-Random Factor [-99...+99]

For more information, see “Rhythm Group” on page 1035, and “Pools-Random Factor” on page 1037.

### Pools-Weighting Curve [0...3]

0: Exponential      2: Exp-S  
1: Logarithmic      3: Log-S

For more information, see “Rhythm Group” on page 1035, and “Pools-Weighting Curve” on page 1037, and “Random Weighting Curves” on page 1086.

The following table summarizes the effect of the various Weighting Curves and the Factor field on the choices from the Cluster Pattern Pools:

Cluster Pool values that receive priority:		
Weighting Curve	Factor	
	+ (positive)	- (negative)
Exp/Log	larger	smaller
Exp-S/Log-S	middle	smaller/larger

## Associated Parameters

### Template Parameters

The two Template Parameters select from 63 or 64 different Cluster Pattern Templates, and load the parameters into the current Phase's Pattern Grid and associated parameters.

A Cluster Pattern Template consists of:

- the configuration of the Cluster Pattern Grid
- Random Weighting Parameters.

### Template [1...63]

☞ p.1039 “Rhythm Group”: “Template”.

### Template + Restore [0: [As Stored]...63]

☞ p.1039 “Rhythm Group”: “Template + Restore”.

# Velocity Group

## Overview

The **Velocity Group** controls most of the aspects that affect the velocities of the notes in the Generated Effect.

## About Velocity Patterns

A Velocity Pattern represents amounts to be subtracted from the initial velocities of notes as they are about to be generated. This can therefore be used to provide patterns of accents in the generated notes, while retaining some of the original velocity information if desired. Choices can be made from “Random Pools” of values as described in detail later on.

Initial velocity is determined by the setting of the “Velocity Mode,” and how hard the notes are played when providing input notes. If “Velocity Mode” was set to **Constant - 124**, then all of the generated notes would have an Initial Velocity of 124. Playing them with a Velocity Pattern of {0, - 20, - 40} would produce the following accented velocities:

124, 104, 84, 124, 104, 84, etc.

Velocity Patterns are additive to Velocity Envelopes, and are compressed to the degree that the envelope approaches zero. In other words, a wide Velocity Pattern will become less wide as the envelope approaches zero to prevent notes from disappearing.

Velocity Patterns may be scaled by the “Velocity Scale” parameter, yielding precise control over how a Velocity Pattern affects an instrument, and additional variations.

A Velocity Pattern will loop as long as note generation continues. It normally will not reset to the beginning of the Pattern unless a new Trigger is received, or the Phase Pattern has been configured to restart it at the beginning of certain Phases. That means that a four step Note Pattern can be looping while an eight step Velocity Pattern and a twelve step Cluster Pattern are also independently looping, for example.

## Global Parameters

### Velocity Mode [0...2]

0: Actual    1: Average    2: Constant

Controls how the actual velocities of the notes received as input source material affect the velocities of the notes as they are generated.

 When the “Velocity Mode” is **0: Actual** or **1: Average**, the Velocity Range Bottom/Top parameters are available. When the Velocity Mode is **2: Constant**, the Velocity Value parameter is available.

#### 0: Actual

The actual velocities received are used as the “Initial Velocity” for each note as they are generated. Loud notes (and their generated counterparts) will play loud, and vice versa. The Velocity Range Bottom and Top parameters are operable, allowing you to scale the amount of sensitivity.

#### 1: Average

The notes received as input have their velocities averaged, and this is then used as the Initial Velocity at which to generate notes. The Velocity Range Bottom and Top parameters become operable, allowing you to scale the amount of sensitivity.

Using this mode allows the velocities received as input to control the overall volume of the resulting effect. For example, you might use this mode so that playing chords hard made the strumming of a guitar a bit louder overall, but where the resulting velocities in each note of a cluster are the same.

#### 2: Constant

The velocities of the notes received as input are ignored; the Velocity Value parameter becomes operable and specifies directly the initial velocity value at which to generate the notes. For example, entering 124 will generate all notes with an initial velocity of 124.

### Velocity Value [1...127]

Sets the Initial Velocity value at which to generate notes. For example, entering “124” will generate all notes with an initial velocity of 124. The Pattern Values and Velocity Scale are then factored in to yield the actual generated velocities.

 Not available unless “Velocity Mode” = **2: Constant**.

### Velocity Range Bottom [1...127]

### Velocity Range Top [1...127]

Sets the overall velocity sensitivity range for input notes, which yields the Initial Velocity to which the Pattern Values and Velocity Scale is applied. Setting **Bottom/Top** to 1/127 will provide full sensitivity (any input note with a velocity of 1–127 will go into KARMA as played). Moving the bottom value up decreases the overall sensitivity while making the notes gradually louder - for example, with a setting of 64/127, an input velocity of 64 would enter KARMA as 96 (velocities in the range 1–127 are scaled into the range 64–127, or 50% louder). Moving the top value down decreases overall sensitivity while making the notes gradually softer - for example, with a setting of

1/64, an input velocity of 64 would enter KARMA as 32 (velocities in the range 1–127 are scaled into the range 1–64, or 50% softer).

**Note:** Setting the two values to the same value creates a constant value, and would be the same as using “Velocity Mode” = 2: **Constant**. For example, setting the Mode to Average with a range of 64/64 is the same as Constant with “Velocity Value” = 64.

**Randomize Bottom** [-12...+12]

**Randomize Top** [-12...+12]

Sets a range of randomization to be applied to each note’s velocity as it is generated. Note that this can be used to make the velocity of each note in a cluster slightly different, while using the Velocity Pattern to generate random velocities applies to each cluster as a whole. Useful for more human-sounding effects, with less machine-like precision.

## Pattern Grid & Associated Parameters

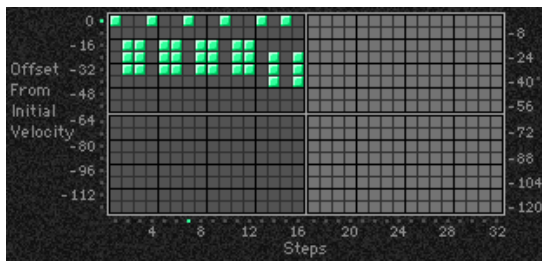

### Velocity Pattern

A Velocity Pattern has any number of steps up to 32, with each step being represented by one column on the grid. The first column always contains at least one

value; unused columns appear disabled. From the top, the 16 rows represent increasing amounts of velocity offsets to be subtracted from the Initial Velocity of the input notes (as determined by the Velocity Mode). It is important to note that the reason the pattern operates with negative, subtractive values rather than absolute positive values is so that it can be applied to the actual initial velocities of the input source material, thereby superimposing a pattern of accents while not destroying already existing velocity nuances (if desired).

 Pattern grids cannot be viewed or edited on the KRONOS.

## Random Weighting Parameters

The Random Weighting Parameters are made available when at least one step (column) in the Velocity Pattern has multiple values selected (constituting a “random pool” of values).

 p.1037 “Rhythm Group”: “Random Weighting Parameters - Pools”

**Pools-Random Factor** [99...+99]

 p.1037 “Rhythm Group”: “Pools-Random Factor”

**Pools-Weighting Curve** [0...3]

- 0: Exponential      2: Exp-S
- 1: Logarithmic    3: Log-S

For more information, see “Rhythm Group” on page 1035, “Pools-Weighting Curve” on page 1037, and “Random Weighting Curves” on page 1086.

The following table summarizes the effect of the various Weighting Curves and the Factor field on the choices from the Velocity Pools:

Velocities that receive priority:		
Weighting Curve	Factor	
	+ (positive)	- (negative)
Exp/Log	louder	softer
Exp-S/Log-S	middle	louder/softer

## Associated Parameters

**Cluster Mode** [0, 1]

- 0: Single-1 Step Per Cluster
- 1: Multi-1 Step For Each Note In Cluster

### 0: Single-1 Step Per Cluster

Each time a note, cluster of notes, or group of drum notes is generated one Velocity Pattern Value will be chosen for the current step, after which the Velocity Pattern advances to the next step. For example, a cluster of six notes will all be generated with the same velocity and advance the Velocity Pattern by one to the

next step. This is useful for creating very noticeable “accented patterns” within effects using large clusters of notes such as gated techno effects.

### 1: Multi-1 Step For Each Note In Cluster

For every note in a cluster or group of drum notes generated simultaneously, a separate Velocity Pattern Value will be chosen after which the Velocity Pattern advances to the next value. For example, a cluster of six notes will be generated with the next six Velocities indicated by the pattern, with a net advance of six steps. This means that each note in a cluster or each

note of a drum pattern that is generated simultaneously can be given its own velocity. This is useful for more subtly shifting accents within clusters of notes, and adding more human-like velocity randomness to drum patterns.

- 🔧 When the “GE Type” (⚙️p.1023) is **0: Generated-Riff**, setting this to **1: Multi** will have no effect unless there is a Cluster Pattern containing values of more than just one.
- 🔧 When the “GE Type” is **1: Generated-Gated**, the number of notes being generated is considered the Cluster Size, and setting this to **1: Multi** will cause the pattern to advance by the number of notes being generated.
- 🔧 When the “GE Type” is **2: Generated-Drum**, setting this to **1: Multi** will have no effect unless at least one Drum Pattern has the “[c] (clusters)” button turned on in the Phase Pattern and there is a Cluster Pattern containing values of more than just 1, or more than one drum note is being generated at a time (by using Drum Patterns in “Poly” mode).

### Scale [-999...+999 (%)]

Sets a percentage by which the chosen Velocity Pattern is scaled before being applied. Notes can be made to disappear or drop out using large positive values; large negative values with a very soft initial velocity can create interesting “reversed” effects.

Note that this can be used to “increase the resolution” of the Velocity Pattern Grid; for example, at **+100%** the offsets match the values displayed on the vertical axis; at **+50%** the offsets would be divided by two, for a difference of four between each value rather than eight and an overall range of **0 to -60**; at **+25%** the offsets would be divided by four for a difference of two between each value and an overall range of **0 to -30**. Conversely, at **+200%** the offsets would be multiplied by two, for a difference of sixteen between each value and an overall range of **0 to -240**, meaning that some notes will drop out and leave “holes” in the sequence of notes (since any note with a velocity less than 1 is not generated).

- 🔧 Not available if “GE Type” (⚙️p.1023) = **2: Generated-Drum**; each pattern in the Drum Group has a separate Velocity Scaling parameter.

### Template Parameters

The two Template Parameters select from 63 or 64 different Velocity Pattern Templates, and load the parameters into the current Phase's Pattern Grid and associated parameters.

A Velocity Pattern Template consists of:

- the configuration of the Velocity Pattern Grid
- Random Weighting Parameters.

### Template [1...63]

⚙️p.1039 “Rhythm Group”: “Template”.

### Template + Restore [0: [As Stored]...63]

⚙️p.1039 “Rhythm Group”: “Template + Restore”.

## CCs/Pitch Group

### Overview

The **CCs/Pitch Group** allows the editing of parameters that control generation of **CC (Control Change) messages**. For example, this can control the panning (CC #10) of the notes in the Generated Effect (stereo placement left to right). Any other CC data may also be generated to control any MIDI controllable characteristic of your synthesizer, such as resonance, filter frequency, vibrato, etc. You may also use the CC

Pattern to generate stepped Pitch Bend messages, technically not a "CC." Depending on internal settings of the GE, the CC Pattern may also be used to specify "Pitch Offsets" that will be applied as Transpose Values to each note as it is generated. This can be used to simulate the Triton Arpeggiator Pitch Offset value for each step, in addition to providing other interesting and useful effects.

### About CC/Bend/Pitch Patterns

A value derived from a CC/Bend Pattern is a MIDI Control Change value from 0–127 (or Pitch Bend, or Pitch Transpose Values, if selected). The values are sent out as each note or cluster of notes is generated. Choices can be made from "Random Pools" of values as described in detail later on.

If the selected CC is 10 (Pan) for example, a CC Pattern such as {0, 127} would cause every other note to pan to the opposite side of the stereo spectrum. A CC Pattern of {0, 0, 0, 0, 127, 127, 127, 127} would play four notes left, then four notes right. A CC Pattern may be inverted at any time (caused to go in the opposite

direction, 127 – 0) by using the **Polarity** Parameter, which is an easy way to reverse the direction of the pattern.

A CC Pattern will loop as long as note generation continues. It normally will not reset to the beginning of the Pattern unless a new Trigger is received, or unless the Phase Group has been configured to restart it at the beginning of certain Phases. This means that a four step CC Pattern can be looping while an eight step Velocity Pattern and a twelve step Cluster Pattern are also independently looping, for example.

### Pattern Grid & Associated Parameters

CC grid when being used for CCs or Pitch Bend

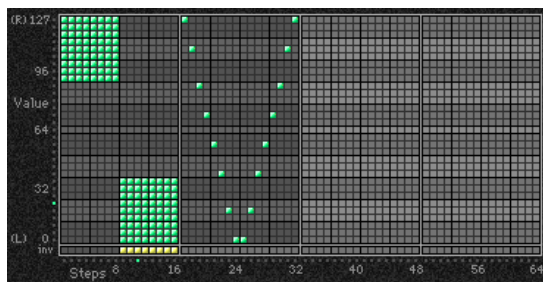

#### CC Pattern

A CC Pattern represents a series of values indicating a MIDI Control Change (or Pitch Bend) value to be generated. It may have any number of steps up to 64, and loop independently of other patterns being used at the same time. Each step is represented by one column on the grid. The first column always contains at least one value. Each row represents a CC or Pitch Bend value in multiples of **four** (0, 4, 8, 12 etc.). The special bottom row ("inv") indicates whether or not to invert the Random Weighting Curve (discussed later on) for any pools within that column.

Depending on internal settings of the GE, the Phase 2 CC Pattern may be used to specify "Pitch Offsets" for notes as they are generated. In this case, the grid is split into two portions: the top portion (Pitches) contains 25 rows, corresponding to a Transpose value of -12 to +12 semitones. The bottom portion (Octaves) contains 7 rows, corresponding to a Transpose value of -3 to +3

octaves. By combining the two Transpose values, any offset from -48 to +48 can be achieved. This can be used to simulate the Triton Arpeggiator Pitch Offset value for each step, in addition to providing other interesting and useful effects.

CC grid when being used for Pitch Offsets

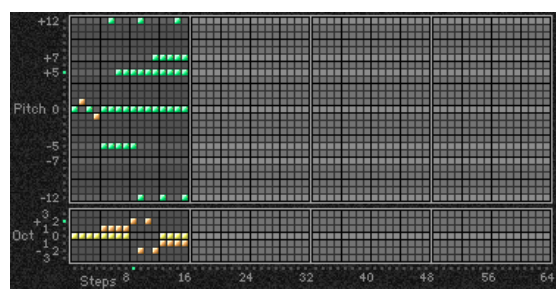

⚠ Pattern grids cannot be viewed or edited on the KRONOS.

#### Associated Parameters

##### Fixed On

[0...128]

0...127: fixed CC value      128: Pattern

When set to **128**, the Pattern Grid becomes operative, and the Pattern is sent out. When set to any other value, a single CC or Pitch Bend value corresponding to the fixed value is sent, and the Pattern Grid becomes inoperative. This allows you to override the Pattern with a fixed value.

 Not available in Phase 2 when Pitch Offsets are being used.

**CC Mode** [0...5]

- 0: Pattern
- 1: Index to 0...127
- 2: Index to 24...108
- 3: Index to 32...96
- 4: Index to 0...64
- 5: Index to 64...127

 Not available in Phase 2 when Pitch Offsets are being used.

**0: Pattern**

When **0: Pattern** is selected, the Pattern Grids will be used to generate the assigned CC/Bend.

**Index**

The 1–5: Index to options allow the data to be generated based on the position of the index in the Note Series from left to right. For example, when set to **1: Index to 0...127**, the index of the note in the Note Series (about to be generated) is compared to the minimum and maximum indexes that will be generated according to the current settings and scaled into a value from **0–127** so that the first index to be used generates **0** and the last **127**, with indexes in between being scaled accordingly. The **Polarity** button can invert this for the opposite effect (**127–0**). Can be useful for simulating stereo miking of an instrument like a piano or harp (with Pan data CC 10), or for

simply tracking the movement of the indexes with any other CC data. The Pattern Grid described above will not be available.

**1: Index to 0...127**

Scales generated notes into CC or Pitch Bend values **0–127**.

**2: Index to 24...108**

Scales generated notes into CC or Pitch Bend values **24–108**.

**3: Index to 32...96**

Scales generated notes into CC or Pitch Bend values **32–96**.

**4: Index to 0...64**

Scales generated notes into CC or Pitch Bend values **0–64**.

**5: Index to 64...127**

Scales generated notes into CC or Pitch Bend values **64–127**.

**Polarity**

[0, 1]

- 0: Regular (+)
- 1: Inverted (-)

**0: Regular (+)**

The CC Pattern is sent out as originally created.

**1: Inverted (-)**

The CC Pattern is inverted; i.e. **0** is sent out as **127**, **127** is sent out as **0**, **96** is sent out as **32**, etc. This allows the same pattern to be used in two different directions.

## Random Weighting Parameters

The Random Weighting Parameters are made available when at least one step (column) in the CC Pattern has multiple values selected (constituting a “random pool” of values).

For more information, see “Rhythm Group” on page 1035 and “Random Weighting Parameters - Pools” on page 1037.

**Pools-Random Factor** [-99...+99]

For more information, see “Rhythm Group” on page 1035 and “Pools-Random Factor” on page 1037.

**Pools-Weighting Curve** [0...3]

- 0: Exponential
- 1: Logarithmic
- 2: Exp-S
- 3: Log-S

For more information, see “Rhythm Group” on page 1035, “Pools-Weighting Curve” on page 1037, “Appendices” on page 1084, and “Random Weighting Curves” on page 1086.

The following table summarizes the effect of the various Weighting Curves and the Factor field on the choices from the CC Pools:

CC Pool values that receive priority:		
Weighting Curve	Factor	
	+ (positive)	- (negative)
Exp/Log	higher in grid	lower in grid
Exp-S/Log-S	middle	higher/lower

**Note:** Turning on the Weighting Curve Inversion Row button causes the opposite behavior specified above (in that step).

**Pitches-Random Factor** [-99...+99]

Controls the shape of the weighting curve being applied to the top part of the CC Pattern Grid (Pitches).

For more information, see “Rhythm Group” on page 1035 and “Random Weighting Parameters - Pools” on page 1037.

 This is valid only if the GE settings make the Phase 2 CC pattern specify Pitch Offset values.

**Pitches-Weighting Curve** [0...3]

- 0: Exponential
- 1: Logarithmic
- 2: Exp-S
- 3: Log-S

Chooses a weighting curve shape for the top part of the CC Pattern Grid (Pitches).

For more information, see “Rhythm Group” on page 1035, “Random Weighting Parameters - Pools” on page 1037, and “Random Weighting Curves” on page 1086.

 This is valid only if the GE settings make the Phase 2 CC pattern specify Pitch Offset values.



**Octaves-Random Factor** [-99...+99]

Controls the shape of the weighting curve being applied to the bottom part of the CC Pattern Grid (Octaves).

For more information, see “Rhythm Group” on page 1035 and “Pools-Random Factor” on page 1037.

🔺 This is valid only if the GE settings make the Phase 2 CC pattern specify Pitch Offset values.

**Octaves-Weighting Curve** [0...3]

0: Exponential      2: Exp-S  
1: Logarithmic      3: Log-S

Chooses a weighting curve shape for the bottom part of the CC Pattern Grid (Octaves).

For more information, see “Rhythm Group” on page 1035, “Pools-Weighting Curve” on page 1037, and “Random Weighting Curves” on page 1086.

🔺 This is valid only if the GE settings make the Phase 2 CC pattern specify Pitch Offset values.

## Global Parameters

**CC-A** [-1...126]

**CC-B** [-1...126]

-1: Off                      96...125: [N/A]  
0...95: CC#00...CC#95      126: Pitch Bend

Selects one of the supported Control Change messages, in addition to **126: Pitch Bend**.

**Note:** CC-A and CC-B may be generated simultaneously, with the same or different values, in alternation, and other variations depending on internal settings of the GE.

🔺 Even if CC-A or CC-B are properly activated, you may not be hearing any effects if the “Transmitted MIDI Filter: “CC-A/CC-B” parameters (“CC-A/CC-B” on page 111) have been set to filter out the data that KARMA is generating.

## Associated Parameters

**Cluster Mode** [0, 1]

0: Single-1 Step Per Cluster  
1: Multi-1 Step For Each Note In Cluster

**0: Single-1 Step Per Cluster**

Each time a note, cluster of notes, or group of drum notes is generated one CC Pattern Value will be chosen for the current step, after which the CC Pattern advances to the next value. For example, a cluster of 6 notes will be generated with a single CC value preceding it, and advance the pattern by 1 to the next step.

**1: Multi-1 Step For Each Note In Cluster**

For every note in a cluster or group of drum notes generated simultaneously, a separate CC Pattern Value will be chosen after which the CC Pattern advances to the next value. For example, a cluster of 6 notes will be generated with each note preceded by the next 6 CC values indicated by the pattern, with a net advance of 6 steps. This means that each note in a cluster or each note of a drum pattern that is generated simultaneously can be given its own CC value - but only if your synth supports this type of behavior.

This will also affect the “Note Number” Pattern Type options. If **0: Single**, a cluster of notes will be preceded by one CC value according to the pitch of the first note; if **1: Multi**, each note will get a corresponding CC value. For example, if generating pan data, this can be used to pan each note of a cluster across the selected range according to its pitch (but only if your synth supports this type of behavior).

🔺 When the “GE Type” (“GE Type” on page 1023) is **1: Generated-Gated**, the number of notes being generated is considered the Cluster Size.

🔺 When the “GE Type” is **0: Generated-Riff**, setting this to **1: Multi** will have no effect unless there is a Cluster Pattern containing values of more than just 1.

🔺 When the “GE Type” is **2: Generated-Drum**, setting this to **1: Multi** will have no effect unless at least one Drum Pattern has the “[c] (clusters)” button turned on in the Phase Pattern and there is a Cluster Pattern containing values of more than just 1, or more than one drum note is being generated at a time (by using more than one Drum Pattern, or by using a single Drum Pattern in “Poly” mode).

**Pitch Offsets On/Off** [0, 1]

0: Off                      1: On

When On: 1, the Pitch Offset pattern specified by the Phase 2 CC Pattern grid is applied as transpose values to notes as they are generated. This allows the effect of the pattern to be switched on and off in realtime. This will not have any effect unless internal settings of the GE specify that Pitch Offsets are being used.

**P.Offset Chord Shift** [0...2]

0: Off                      1: Scalic1                  2: Scalic2

**0: Off**

The Pitch Offsets are applied with no further modification from this setting.

**1: Scalic1**

Chord analysis is performed on the input source material, and as the Pitch Offset values are applied to transpose the generated notes, notes that may be “atonal” based on the analyzed chord are shifted to tonal notes. Useful for creating complex chromatic Pitch Offset Patterns and ensuring that the results stay



in a certain key or chord. The note tables used to shift the notes are the same as the ones used in Note Series Group “Note Type”: **1: Scalic**. For more information, see “Note Type” on page 1026.

### **2: Scalic2**

Same as 1: Scalic (above), except that the note tables used to shift the notes are the same as the ones used in “Note Series Group “Note Type”: **2: Scalic2**. Scalic2 is more modal in nature and has more passing tones than **1: Scalic**.

 Will not have any effect unless internal settings of the GE specify that Pitch Offsets are being used.

### **Template Parameters**

The two Template Parameters select from 63 or 64 different CC/Pitch Pattern Templates, and load the parameters into the current Phase's Pattern Grid and associated parameters.

A CC/Pitch Pattern Template consists of:

- the configuration of the CC Pattern Grid
- Random Weighting Parameters
- Polarity

### **Template** **[1...63]**

For more information, see “Rhythm Group” on page 1035, and “Template” on page 1039.

### **Template + Restore** **[0: [As Stored]...63]**

For more information, see “Rhythm Group” on page 1035, and “Template + Restore” on page 1039.

## WaveSeq Group

### Overview

The WaveSeq Group controls a set of parameters that allow the waveforms of the KRONOS's programs to be varied in real-time, creating popular "wave-sequence" style effects.

### About WaveSeq Patterns

WaveSeq Patterns control the waveforms of the synth programs that are being used to generate notes. Here you can sequence a pattern of up to 32 different waveforms (16 in each phase). A value derived from a WaveSeq Pattern is the ID of a specific waveform. Choices can be made from "Random Pools" of values. The waveforms change with each note (although you can specify a number of steps containing the same waveform, of course, so that it repeats the same waveform for a number of notes.)

You can set up effects that more resemble traditional wave sequences by setting the Index Group or the Note Series to only repeat a single pitch, or by using "GE Type" = **1: Generate-Gated**, with "Gate Type" = **0: Vel**, instead of generating notes all over the place. Then you can concentrate on just changing waveforms, and the notes remain static.

On the other hand, part of the beauty of KARMA wave sequencing is having the notes change in a sequenced fashion, while the waveforms are also changing.

 Presently, it is not possible to have the waveforms change while notes are sustaining, so you cannot use "GE Type" = **1: Generate-Gated**, with "Gate Type" = **CC type** (for chopped pads.)

Alternately, you can have it generate just waveform changes, without actually generating any notes. For example, you can have it randomly pick a new Multisample (from a group you've defined) with each note you play on the keyboard. Or you can assign a range of Multisamples to a Real-Time Control and select the one you want to use, in real-time.

One of the most interesting features is the ability to offset the entire waveform map that you've set up, either by varying the "Wave Offset" parameter, or by tracking it with the keyboard. Since the results are totally dependent on the destination synth's waveform order, completely unexpected and unplanned results can be achieved that would be impossible to get any other way. For example, a WaveSeq Pattern of mallet-like sounds could be shifted instantly into a group of guitar or industrial noise waveforms, radically modifying the resulting timbre of the phrase.

A WaveSeq Pattern will loop as long as note generation continues. It normally will not reset to the beginning of the Pattern unless a new Trigger is received, or the Phase Group has been configured to restart it at the beginning of certain Phases. This means that a four step WaveSeq Pattern can be looping while an eight step Velocity Pattern and a twelve step Cluster Pattern are also independently looping, for example.

### Global Parameters

#### Wave Pattern On/Off

[0, 1]

0: Off      1: On

An overall switch for turning the WaveSeq effect On/Off. Setting to **0: Off** will return the program to normal operation (and may optionally reset the waveforms to their original values, if your synth supports this behavior). In the KRONOS, this allows you to activate the WaveSeq effect in real-time, where turning it Off sets the timbres being affected back to their original waveforms.

#### Oscillator Mode

[0...4]

0: Osc1 In Both Phases  
 1: Osc2 In Both Phases  
 2: Alternate (Osc1 Phase 1, Osc2 Phase 2)  
 3: Split (Osc1 Phase 1, Osc2 Phase 2, simultaneously)  
 4: Both (Osc1 & Osc2 same, simultaneously)

Specifies several ways that two different oscillators in the destination program(s) can be controlled, with regards to the two different Phases of a GE.

#### 0: Osc1 In Both Phases

The specified waveforms will be selected according to the switching of the Phase Pattern, but only for Oscillator 1. During steps utilizing Phase 1, the Phase 1 Pattern will be used to change the waveforms, and during steps utilizing Phase 2, the Phase 2 Pattern will likewise be used. Oscillator 2 (if used in the program) will not be affected.

#### 1: Osc2 In Both Phases

The specified waveforms will be selected according to the switching of the Phase Pattern, but only for Oscillator 2. During steps utilizing Phase 1, the Phase 1 Pattern will be used to change the waveforms, and during steps utilizing Phase 2, the Phase 2 Pattern will likewise be used. Oscillator 1 will not be affected.

 This setting will have no effect on a single-oscillator or drum program.

**2: Alternate (Osc1 Phase 1, Osc2 Phase 2)**

During playback of Phase 1, Oscillator 1 waveform changes will be generated. During playback of Phase 2, Oscillator 2 waveform changes will be generated. Therefore, the Phase 1 Pattern and parameters are associated with Oscillator 1, and the Phase 2 Pattern and parameters are associated with Oscillator 2. When in Phase 1, Osc 2 will remain on the last sent waveform change of Phase 2, and when in Phase 2, Osc 1 will remain on the last sent waveform change of Phase 1. This creates an “alternating” sort of effect between the two oscillators, where one oscillator will change for a period of time, then the other, but not at the same time.

- 🔍 The Phase 2 parameters will have no effect on a single-oscillator or drum program.

**3: Split (Osc1 Phase 1, Osc2 Phase 2, simultaneously)**

The Phase 1 Pattern and parameters are associated with Oscillator 1, and the Phase 2 Pattern and parameters are associated with Oscillator 2. However, they generate waveform changes simultaneously, ignoring the Phase Pattern settings. For example, this

means the Pattern Grid in Phase 1 can be used to generate a wave-sequence pattern for Osc 1, at the same time that the Pattern Grid in Phase 2 can be used to generate a completely different wave-sequence pattern for Osc 2. The switching of Phases which normally occurs according to the Phase Pattern is ignored, and they both generate waveform changes for their respective oscillators simultaneously, all the time.

- 🔍 The Phase 2 parameters will have no effect on a single-oscillator or drum program.

**4: Both (Osc1 & Osc2 same, simultaneously)**

The two oscillators are controlled in tandem. The Phase Pattern switching between Phases is used as normal, but both Osc 1 & 2 are changed as specified by the Pattern (with the same values). For example, you can set up a complex pattern of up to 16 waveforms in Phase 1, and a different complex pattern with different waveforms in Phase 2, and let the Phase Pattern control switching between them. Every time Osc 1 is changed, Osc 2 will also change to the same waveform.

---

## Pattern Grid & Associated Parameters

A WaveSeq Pattern specifies a sequence of waveform select messages to be sent, thereby changing the waveform of the sound with each note (if desired).

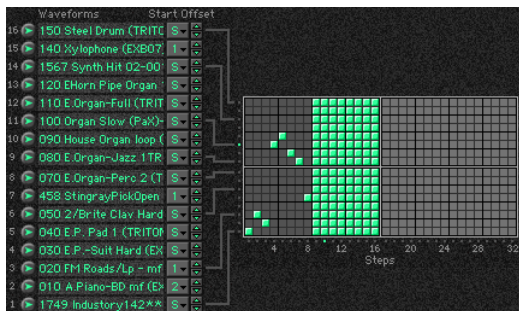

A WaveSeq Pattern may have any number of steps up to 32, and loop independently of other patterns being used at the same time. Each step is represented by one column on the grid. The first column must always contain at least one value; unused columns appear disabled.

More than one value can be entered in any given column, which then becomes a “random pool” from which choices will be made at random, subject to the use of a weighting curve as described later on. The weighting curve becomes available when there is at least one random pool selected. The example above shows a pattern of 8 single waveform choices in the first 8 steps, after which waveform choices are made at random from the entire group of 16 waveforms for an additional 8 steps. Whether or not the random choices will be different each time through the Phase is controlled in the Phase Group; you can choose to repeat the same random sequence a number of times or always generate new random sequences of choices.

Also controlled in the Phase Group is whether or not the WaveSeq Pattern will start from the beginning each time a Phase starts. For example, assume the pattern

contained ten items and a Phase only used eight of them before changing to a different Phase. If the pattern was not set to restart in the Phase Group, then the second time through the same Phase it would pick up where it left off: at the 9th value of the pattern.

- 🔍 Pattern grids cannot be viewed or edited on the KRONOS.

**Row 1...16 Waveform [000...2261]**

Selects a waveform for the corresponding row of the Pattern Grid.

**Row 1...16 Start Offset [0...8]**

0: Sample Start

1...8: 1st...8th

Chooses one of the available start offset points for the selected waveform.

- 🔍 The actual value will be limited internally to the available number of Start Offsets for the specified waveform, which may be different from the full range of 0...8.

**Waveform Type [0, 1]**

0: MultiSound

1: WaveSequence

Specifies whether the messages sent will change the program's oscillator(s) to different Multisamples, or different Wave Sequences.

**0: MultiSound**

The choices indicated by the pattern values will cause various Multisamples to be selected for the specified oscillators.

**1: WaveSequence**

The choices indicated by the pattern values will cause various Wave Sequences to be selected for the specified oscillators.

**Waveform Offset** [-999...999]

Offsets the entire group of 16 Waveform Choices by the specified amount (each waveform has the specified number added to it.) This can be a quick way to transform a pattern into a completely unexpected result. Waveforms will be limited to the first and last waveforms if the offset causes them to go out of range.

**Keyboard Track (C2)** [0, 1]

0: Off      1: On

When **1: On**, allows the specified 16 Waveform Choices to track the keyboard (lowest note played, with reference to C2 - Note# 36). In other words, the 16 waveforms will be used exactly as specified when the lowest input note played is a C2. If the lowest note is higher or lower than C2, the number of steps that it is

higher/lower will be added to or subtracted from each waveform, offsetting the entire group. This provides a completely different resulting wave-sequence depending on where the input notes are played.

**Pattern Length** [1...32]

Specifies the number of steps of the Waveform Pattern that will be used during note generation. This allows you to loop a smaller portion of the entire pattern. For example, if the Waveform Pattern grid has been set up with a 20 step pattern, and "Pattern Length" = 3, then only the first three steps of the pattern will be used to generate notes. Those three steps will loop continuously as the GE generates notes, and the other steps will not be used. To use all steps of any Waveform Pattern that is loaded, even when changing Waveform Templates, set this to 32.

## Random Weighting Parameters

The Random Weighting Parameters are made available when at least one step (column) in the WaveSeq Pattern Grid contains multiple values selected (constituting a "random pool" of values). Whenever a random pool is encountered in playing through the pattern, a random choice is made from the values in that step. Certain areas of the random pool can be favored by the use of a weighting table, with various shaped curves. Using the curves, you can influence certain choices to be made more or less often than others, allowing very musical real-time control of the randomness.

Whether or not a certain random sequence will repeat for a number of times is controlled by the Phase Group.

For more information, see "Rhythm Group" on page 1035, and "Random Weighting Parameters - Pools" on page 1037.

**Pools-Random Factor** [-99...+99]

For more information, see "Rhythm Group" on page 1035, and "Pools-Random Factor" on page 1037.

**Pools-Weighting Curve** [0...3]

0: Exponential      2: Exp-S  
1: Logarithmic      3: Log-S

For more information, see "Rhythm Group" on page 1035, "Pools-Weighting Curve" on page 1037, and "Random Weighting Curves" on page 1086.

The following table summarizes the effect of the various Weighting Curves and the Factor field on the choices from the WeveSeq Pools:

WaveSeq Pool values that receive priority:		
Weighting Curve	Factor	
	+ (positive)	- (negative)
Exp/Log	higher in grid	lower in grid
Exp-S/Log-S	middle	higher/lower

## Associated Parameters

### Template Parameters

The two Template Parameters select from 63 or 64 different WaveSeq Pattern Templates, and load the parameters into the current Phase's Pattern Grid and associated parameters.

A WaveSeq Pattern Template consists of:

- the configuration of the Pattern Editing Grid
- the sixteen "Waveform Choice" values, and the corresponding "Start Offset" values.
- Random Weighting Parameters

**Template** [1...63]

For more information, see "Rhythm Group" on page 1035, and "Template" on page 1039.

**Template + Restore** [0: [As Stored]...63]

For more information, see "Rhythm Group" on page 1035, and "Template + Restore" on page 1039.

## Envelope Group

### Overview

Each Generated Effect has **3 envelopes** which can be applied to various options such as Velocity, Tempo, Pitch Bend, Duration, Repeat Time, and any CC (Control Change).

### About Envelopes

For those of you familiar with synthesizer envelopes, these are standard **ADSR** Envelopes, with the addition of a Start Level. For those who are not, ADSR stands for “Attack, Decay, Sustain, Release”. When the envelope is triggered in some fashion like a key being depressed, the envelope starts at the Start Level and moves to the Attack Level in the amount of time specified by Attack Time. This is the “Attack Phase” of the envelope. Once the envelope reaches the Attack Level, it then immediately continues to the Sustain Level in the amount of time specified by Decay Time. This is the “Decay Phase”. When it reaches the Sustain Level, it will remain there until some event causes it to enter the “Release Phase,” typically a key being released. The envelope then moves to the Release Level in the amount of time specified by Release Time.

An envelope simply describes the shape of some function, and the time that it takes. In the case of KARMA GE, the function is either a crescendo/decrescendo of the velocity levels of the notes in the phrase, an accelerando/ritard of the speed

at which the notes are generated, an overall sweeping of the pitch, a continuous varying of a selected CC (MIDI Control Change), etc.

Note that in the case of Velocity Envelopes, the envelope’s shape is subtractive to the Initial Velocity Level generated according to the “Velocity Mode” Parameter. (PG.1049) The loudest value the envelope will produce is the Initial Velocity received. However, when low Initial Velocities are received, the Envelope is automatically scaled so that a consistent shape is maintained regardless of the value. In other words, the Envelope will be compressed to the degree that the Initial Velocity is less than 127. For more information on Initial Velocity, see Velocity Group/“Velocity Mode.”

When and how the Envelopes will be triggered is determined by the Envelope Trigger Parameters (Envelope1, Envelope2, Envelope3: “Trigger”) in the KARMA Module parameters. For more information, see “7-4b: Module Parameters-Trigger” on page 117.

In addition to being triggered by the keyboard, the envelopes can also be selectively triggered at Phase Changes according to settings in the Phase Group.

### Parameters

The parameters are the same for all three of the envelopes, and are discussed below.

#### On/Off (Envelope On/Off) [0, 1]

0: Off      1: On

Turns on the corresponding envelope, and makes its parameters operative.

**Note:** Even if the envelope is properly activated, you may not be hearing any effect if the “Transmit MIDI Filter: Envelope1/Envelope2/Envelope3” parameters (PG p.111) have been set to filter out the data that KARMA is generating.

#### Envelope Type

[0...127]

- 0: [VE] Velocity
- 1: [TA] Tempo-Absolute
- 2: [TR] Tempo-Relative
- 3: [PB] Pitch Bend
- 4: [DU] Duration
- 5: [RT] Repeat Time
- 6: [00] Bank Select
- 7...100: [#00...#95] CCs (Control Changes)
- 101...127: [N/A]

Selects the function that the envelope performs. The first six settings are specific predetermined types, while the others allow any MIDI CC Message to be sent by the envelope.

#### 0: [VE] Velocity

Controls the crescendo and decrescendo of the Riff, much like an Amplitude Envelope controls the volume on a synthesizer. The envelope’s range of **0–99** is scaled into **0–127**, which is then combined with the actual velocities of the notes being generated, to impart an overall velocity shape while maintaining the accents within the individual notes.

**1: [TA] Tempo-Absolute**

Controls the speed of the Riff, for *accelerando* and *ritard* effects. When active, the effect does not sync to the Internal Master Clock or External Sync, but runs on its own clock, controlled by the Tempo Envelope. This means that the envelope is in absolute control of the tempo, and changing the KARMA Tempo has no effect.

**2: [TR] Tempo-Relative**

Controls the speed of the Riff, for *accelerando* and *ritard* effects. When active, the effect does not sync to Internal or External MIDI Clock, but runs on its own clock, controlled by the Tempo Envelope. However, this option takes into account the KARMA Tempo, so if the tempo is slower the Tempo Range of the envelope will also be slower. Note that this does not mean the time over which the envelope operates, which is a different option discussed below under the "Tempo Relative" parameter. (p.1061)

**3: [PB] Pitch Bend**

Controls an overall pitch bend on the entire effect. Note that the overall range of the Pitch Bend can be set in either the Bend Group.

**4: [DU] Duration**

Controls an overall shortening of durations of generated notes. In other words, the normal calculated duration of the note becomes the maximum duration length, and the shape of the envelope scales the durations between 0–100% of the minimum duration length and that value. The minimum and maximum duration values depend on the "Duration Mode" setting in the Duration Group. For more information, see "Duration Group" on page 1040.

**5: [RT] Repeat Time**

Controls an overall shortening of the repeat time that is selected for use in the Melodic Repeat Group. In other words, the normal calculated repeat time becomes the maximum time, and the shape of the envelope scales the repeat time between 0–100% of 1 ms and that value. For example, if the Repeat Rhythm Value was set to a 16th note at 120 BPM, the repeat time would be 125 ms for each note. A Repeat Time Envelope would vary the envelope's range of 0–99 between 1 ms and 125 ms. This can provide interesting "bouncing" delay effects with repeats of the same pitch on drum and perc sounds, among other unique effects.

**Poly Extend, Poly Extend/Damped, Mono Extend:**

The Duration Envelope only affects notes that have durations shorter than the current Rhythm Pattern value (as specified by the Duration Pattern Grid), since the other notes will be auto-extending to the next note or next occurrence of the same note. For the shorter notes, the length of the Duration Pattern Value represents the maximum duration, and the envelope's 0–99 range represents 0–100% of that value, with 1 ms being the minimum duration. To adjust the minimum duration, you would adjust the envelope's level settings to only move between the higher values, i.e. 50–99.

**Timed (Duration Value range: 1...5000 ms)**

The Duration Value represents the maximum duration in milliseconds, and the envelope's 0–99 range represents 0–100% of that value. For example, if the

Duration Value field is set to 250 ms, then the envelope shapes the durations from 1 ms to 250 ms over its 0–99 range. To make the durations go from 125 ms to 250 ms, you would adjust the envelope's level settings so that it moves from 50–99 (50%–100%).

**Rhythm Overlap, Pattern Overlap**

(Duration Value range: -500...500 ms)

The Duration Value represents the maximum overlap or gap (in milliseconds) between successive notes, and the envelope's 0–99 range represents 0–100% of that value. For example, if the Duration Value field is set to +20, then the envelope shapes the durations from -500 ms to +20 ms over its 0–99 range. To adjust the minimum duration, you would adjust the envelope's level settings to only move between the higher values, i.e. 50–99.

**Rhythm %, Pattern %**

(Duration Value range: 1...800%)

The Duration Value represents the maximum percentage of the current Rhythm Pattern Value, and the envelope's 0–99 range represents 0–100% of that value. For example, if the Duration Value field is set to 50%, then the envelope shapes the durations from 1% to 50% of the Rhythm Pattern Value over its 0–99 range. To make the durations go from 25% to 50%, you would adjust the envelope's level settings so that it moves from 50–99 (50%–100%).

**7...100: [#00...#95] CCs (Control Change)**

Send the selected CC value according to the shape of the envelope - the envelope's range of 0–99 is scaled into 0–127 and sent as the selected controller. This is especially useful when you loop the envelopes to get slow, sweeping LFO effects, for controlling various tone generation characteristics on synthesizers and effects devices that support this type of control. Note that for looping to work, you must set the **Loop On** and **Envelope Latch** modes ("Envelope1, Envelope2, Envelope3" on page 118) properly - see the "Loop Mode" parameter below.

The following Level and Time parameters may also be controlled in various combinations by parameters discussed later on in this section.

**Start Level [0...99]**

The level at which the envelope begins when triggered.

**Attack Time [0...99]**

The time it will take to reach the "Attack Lvl (Attack Level)." This is a portion of the overall time setting specified in the "Time Scale" parameter described below.

**Attack Level [0...99]**

The first level which the envelope reaches in the amount of time specified by "Attack Time."

**Decay Time [0...99]**

The time it will take to reach the "Sustain Lev (Sustain Level)" from the Attack Level. This is a portion of the overall time setting specified in the "Time Scale" parameter described below.

**Sustain Level [0...99]**

The second level which the envelope reaches in the amount of time specified by "Decay Time." The envelope will remain at this level until the keys depressed on the keyboard are released, or some other function causes the envelope to enter the Release Phase.

**Release Time [0...99]**

The time it will take to reach the "Rel. Level (Release Level)" once the Release Phase is triggered. This is a portion of the overall time setting specified in the "Time Scale" parameter described below.

**Release Level [0...99]**

The final level the envelope reaches in the amount of time specified by "Rel. Time (Release Level)."

**Amplitude Amount [0...99]**

Represents the maximum level that the envelope will reach. The rest of the envelope is scaled accordingly. For example, if this is set to 50, the envelope's output will be half what the other parameter specify.

**Time Scale [0...10]**

0: R-Riff Length

1...10: 1 to 10 seconds in 1 second increments

Specifies the overall amount of time that each segment will take when set to its maximum value. The envelopes in KARMA GE are 3 segment envelopes; they have an attack segment, decay segment, and release segment. For example, if the attack segment time ("Attack time") was set to 99 and the "Time Scale" to 1 second, the attack segment will take 1000 ms; if "Attack time" was set to 50, then the attack segment will take 500 ms. If the times of all 3 segments were set to 99, the total time of the envelope would be approximately 3 seconds (not taking into account any time spent at the sustain level). When set to 0: **R-Riff Length**, the Time Scale is automatically scaled to the length of the Generated Effect. This can be useful for such things as harp glissandos, where supplying more/less notes as input will cause the resulting envelopes to be slower/faster. Note that if the Phase "Length Mode" is set to 1: **TS-Time Signature**, then the length of a Phase is determined by the Time Signature and not the number of notes played, so the results of setting this to 0: **R-Riff Length** may not be noticeable in that case.

**Attack Smooth [0, 1]**

0: Off 1: On

When set to 0: **Off**, retriggering an envelope will start it at its preset Start Level regardless of its current position. When set to 1: **On**, the envelope will restart from its current position, not the Start Level. This can be used to "smooth" the repeated retriggerings of the envelope.

**Loop Mode [0...3]**

Selects one of several methods of causing the envelope to loop continuously from one point back to another.

0: Off

1: S-Start Level ↔ Sustain Level

2: R-Start Level ↔ Release Level

3: A-Attack Level ↔ Release Level

**0: Off**

The envelope will proceed through all its segments in a normal fashion.

**1: S-Start Level ↔ Sustain Level**

Upon reaching the Sustain Level, the envelope will loop back to the Start Level and start over. Requires Envelope Latch Mode (see "Envelope Latch" on page 119) to be set to **Off**, **Sus1**, or **Sus2**. For continuous looping after key release, you must have **Sus2** selected - see the table below.

**2: R-Start Level ↔ Release Level**

Upon reaching the Release Level, the envelope will loop back to the Start Level and start over. Requires Envelope Latch Mode (see "Envelope Latch" on page 119) to be set to **Rel1** or **Rel2**. For continuous looping after key release, you must have **Rel2** selected - see the table below.

**3: A-Attack Level ↔ Release Level**

Upon reaching the Release Level, the envelope will loop back to the Attack Level and start over. Requires Envelope Latch Mode (see "Envelope1, Envelope2, Envelope3" on page 118, and "Envelope Latch" on page 119) to be set to **Rel1** or **Rel2**. For continuous looping after key release, you must have **Rel2** selected - see the table below.

The following table illustrates the relationship between the 3 Envelope Loop Modes described above, and the Envelope Latch Modes (see "Env1 Latch Mode" on page 126).

Envelope Loop Mode	Envelope Latch Mode				
	Off	Sus1	Rel1	Sus2	Rel2
[S] Start Level ↔ Sustain Level	key release ends loop	key release ends loop	n/a	loop continuously	n/a
[R] Start Level ↔ Release Level	n/a	n/a	key release ends loop	n/a	loop continuously
[A] Attack Level ↔ Release Level	n/a	n/a	key release ends loop	n/a	loop continuously

**Tempo Relative [0, 1]**

0: Off 1: On

When 1: **On**, makes the selected envelope's time scale

relative to tempo. This means that the envelope can **Track** the notes being generated, or a particular length of time. If you have it set to make a particular shape



over 1 bar of 4/4, then changing the tempo will maintain this relationship by scaling the tempo range of the envelope accordingly.

For example, assume you have an envelope timed to produce a sweep over 1 bar of 4/4 at 120 BPM. If you change the tempo to 60 and the “Tempo Reltv” parameter is **0: Off**, the envelope will still operate for the same length of time, therefore sweeping over 1/2 of the bar of 4/4. If you set tempo to 240, it would sweep over 2 measures of 4/4.

With “Tempo Reltv” **1: On**, the time scale of the envelope is changed according to the tempo. Therefore, it will always sweep over 1 bar of 4/4 regardless of the tempo.

Note that you can use this with the **2: [TR] Tempo - Relative Envelope Type** (described above), so that it not only has a range that is influenced by the tempo, but its “Time Scale” is also influenced by the tempo.

### Note Trigger

[0, 1]

0: Off                      1: On

Allows an envelope to be triggered with every single note. When set to **0: Off**, the envelope is triggered normally as specified by the settings of the Envelope Trigger in the KARMA Module parameters, Dynamic MIDI, and the Envelope Triggering settings of the Phase Pattern. For more information, see “Envelope1/Envelope2/Envelope3” on page 111, and “Envelope Trigger” on page 118.

When set to **1: On**, every single note that is generated will retrigger the selected envelope. For example, this can be useful for adding Vibrato to individual notes (using an envelope set to **CC #01 (Mod Wheel)**), or fading in/out individual notes (using an envelope Type of **CC #07 (Volume)** or **CC #11 (Expression)**).

---

## Level Combinations

### Sta/Att Level (Start/Attack Level) [0...99]

Controls an Envelope’s Start and Attack Levels at the same time - both will be set to the same value.

### Sta/Sus Level (Start/Sustain Level) [0...99]

Controls an Envelope’s Start and Sustain Levels at the same time - both will be set to the same value.

### Sta/Rel Level (Start/Release Level) [0...99]

Controls an Envelope’s Start and Release Levels at the same time - both will be set to the same value.

### Att/Sus Level (Attack/Sustain Level) [0...99]

Controls an Envelope’s Attack and Sustain Levels at the same time - both will be set to the same value.

### Att/Rel Level (Attack/Release Level) [0...99]

Controls an Envelope’s Attack and Release Levels at the same time - both will be set to the same value.

### Sus/Rel Level (Sustain/Release Level) [0...99]

Controls an Envelope’s Sustain and Release Levels at the same time - both will be set to the same value.

### Sta/Att/Sus Level (Start/Attack/Sustain Level) [0...99]

Controls an Envelope’s Start, Attack and Sustain Levels at the same time - all will be set to the same value.

### Sta/Att/Rel Level (Start/Attack/Release Level) [0...99]

Controls an Envelope’s Start, Attack and Release Levels at the same time - all will be set to the same value.

### Sta/Sus/Rel Level (Start/Sustain/Release Level) [0...99]

Controls an Envelope’s Start, Sustain and Release Levels at the same time - all will be set to the same value.

### Att/Sus/Rel Level (Attack/Sustain/Release Level) [0...99]

Controls an Envelope’s Attack, Sustain and Release Levels at the same time - all will be set to the same value.

### All Levels [0...99]

Controls an Envelope’s Start, Attack, Sustain and Release Levels at the same time - all will be set to the same value.

---

## Time Combinations

### Att/Dec Time (Attack/Decay Time) [0...99]

Controls an Envelope’s Attack and Decay Times at the same time - both will be set to the same value.

### Att/Rel Time (Attack/Release Time) [0...99]

Controls an Envelope’s Attack and Release Times at the same time - both will be set to the same value.

### Dec/Rel Time (Decay/Release Time) [0...99]

Controls an Envelope’s Decay and Release Times at the same time - both will be set to the same value.

### All Times [0...99]

Controls an Envelope’s Attack, Decay and Release Times at the same time - all will be set to the same value.

## Repeat (Melodic Repeat) Group

### Overview

Melodic Repeat allows any note to be repeated in a delay-like fashion, with many additional features and enhancements. When the GE Type is one of the “Generated” types (i.e. 0: Generated - Riff), the notes as they are generated may each start sequences of repeating notes. When the GE Type is 3: **Real-Time**, the actual input notes may each start sequences of repeating notes.

Based on a familiar technique know as “MIDI Delay,” MIDI notes are repeated at certain time intervals while their velocities decrease, thus imitating the effect of delay in an external effects processor. However, as typically implemented, this causes severe polyphony problems, and the creative options are few. In KARMA, many sophisticated enhancements and improvements have been added, including:

- Slow down the Master Tempo and the repeated notes can remain in time with the original notes.
- Use a Tempo envelope to create drastic accelerandos and ritards and then lock the repeated notes to the envelope.
- Use a Repeat Time envelope to modulate the time between each repeat, for unique rhythmic effects.

- Unique “Duration Modes” not only save polyphony, but create interesting performance options.
- Delayed pitches may be transposed and melodically shifted using Chord Recognition.
- Transposed notes may be rebounded or wrapped around within a range. The range may be an absolute range, or a “sliding” range that tracks the input notes.
- Only notes within a certain velocity range can trigger repeated notes, while others will not.
- The Rhythm Patterns, Index Patterns, Velocity Patterns, etc. may be used to control when and how the repeated notes are generated.

When the “GE Type” (Ⓜp.1023) is one of the Generated types (i.e. 0: **Generated-Riff**), the notes as they are generated may each start strings of repeating notes. When the “GE Type” is 3: **Real-Time**, the actual input notes may each start strings of repeating notes.

Repeats can not be generated when “GE Type” = 1: **Generated-Gated** and “Gate Type” (Ⓜp.1023) is one of the CC Types, since notes are not actually generated in this mode, but a sustained set of notes is manipulated by a selected CC, i.e. “chopped” by CC #11 (**Expression**).

### General Parameters

#### Rhythm

[0...25]

0: None (Instant)	10: 8th triplet	20: Whole
1: 64th triplet	11: 8th	21: Whole Dotted
2: 64th	12: 8th Dotted	22: 2 bars
3: 64th Dotted	13: Quarter triplet	23: 3 bars
4: 32th triplet	14: Quarter	24: 4 bars
5: 32th	15: Quarter Dotted	25: Pattern
6: 32th Dotted	16: Half triplet	
7: 16th triplet	17: Half	
8: 16th	18: Half Dotted	
9: 16th Dotted	19: Whole triplet	

Sets the rhythm (repeat time) for each repeated note (16th note, dotted 16th, etc.). All rhythms chosen here lock to the Global Tempo, or to the Tempo Envelope if “Tempo Env. Lock” is on, described below.

#### 0: None

The repeated notes are put out simultaneously with the generated/input notes, without any delay. This can be used to generate clusters of notes, while using Repeat “Transpose” to change the pitch intervals between them, for creating harmonies and other effects.

#### 1...24: Note Values

Selects a rhythmic value to use for each repeated note (16th note, dotted 16th, etc.) When one of these Note Values is chosen, the same rhythmic value is used for each repeated note.

#### 25: Pattern

The Rhythm Pattern in the Rhythm Group is used), so that repeated notes can have different rhythms.

#### Straight Rhythms

[0...11]

0: None (Instant)	4: 8th	8: 2 Wholes
1: 64th	5: Quarter	9: 3 Wholes
2: 32nd	6: Half	10: 4 Wholes
3: 16th	7: Whole	11: Rhythm Pattern

Selects a setting for the “Rhythm Value” parameter from a subset of the entire range. The subset consists of the straight values (no triplets or dotted values) along with 0: **None** and 11: **Rhythm Pattern**. This is used to provide real-time control of the “Rhythm Value” parameter while excluding certain of the in-between values.

**Dotted Rhythms** [0...8]

- |                   |                   |                   |
|-------------------|-------------------|-------------------|
| 0: None (Instant) | 3: 16th Dotted    | 6: Half Dotted    |
| 1: 64th Dotted    | 4: 8th Dotted     | 7: Whole Dotted   |
| 2: 32nd Dotted    | 5: Quarter Dotted | 8: Rhythm Pattern |

Selects a value for the "Rhythm Value" parameter from a subset of the entire range. The subset consists of the dotted values along with **0: None** and **8: Rhythm Pattern**. This is used to provide real-time control of the "Rhythm Value" parameter while excluding certain of the in-between values.

**Triplet Rhythms** [0...8]

- |                   |                    |                   |
|-------------------|--------------------|-------------------|
| 0: None (Instant) | 3: 16th Triplet    | 6: Half Triplet   |
| 1: 64th Triplet   | 4: 8th Triplet     | 7: Whole Triplet  |
| 2: 32nd Triplet   | 5: Quarter Triplet | 8: Rhythm Pattern |

Selects a setting for the "Rhythm Value" parameter from a subset of the entire range. The subset consists of the triplet values along with **0: None** and **8: Rhythm Pattern**. This is used to provide real-time control of the "Rhythm Value" parameter while excluding certain of the in-between values.

**Selected Rhythms** [0...13]

- |                   |                   |                    |
|-------------------|-------------------|--------------------|
| 0: None (Instant) | 5: 8th Dotted     | 10: 2 Wholes       |
| 1: 64th           | 6: Quarter        | 11: 3 Wholes       |
| 2: 32nd           | 7: Quarter Dotted | 12: 4 Wholes       |
| 3: 16th           | 8: Half           | 13: Rhythm Pattern |
| 4: 8th            | 9: Whole          |                    |

Same as "Straight Rhythm Values," except adds the two most musically useful dotted values also.

**Selected Rhythms2** [0...18]

- |                   |                    |                    |
|-------------------|--------------------|--------------------|
| 0: None (Instant) | 7: 16th            | 14: Whole          |
| 1: 64th Triplet   | 8: 8th Triplet     | 15: 2 Wholes       |
| 2: 64tht          | 9: 8th             | 16: 3 Wholes       |
| 3: 64th Dotted    | 10: 8th Dotted     | 17: 4 Wholes       |
| 4: 32nd Triplet   | 11: Quarter        | 18: Rhythm Pattern |
| 5: 32nd           | 12: Quarter Dotted |                    |
| 6: 16th Triplet   | 13: Half           |                    |

Specially created for Drum GEs, providing the same subset as Selected Rhythm Values (above), with the addition of the most useful short note values.

**Use Swing** [0, 1]

- |        |       |
|--------|-------|
| 0: Off | 1: On |
|--------|-------|

Sets whether the repeated notes will take on the swing feel that is set in the Rhythm Group. If **0: Off**, the generated notes may be swung but the repeated notes will not be. Note that triplet rhythm values are not affected by swing.

 When the Rhythm Group "Swing %" parameter ("Swing %" on page 1035) is **0**, this parameter has no effect.

**Time Offset (ms)** [-127...+127]

Allows a positive or negative millisecond offset to be applied to very short repeat times, making them slightly shorter or longer. One use is to "tune" to a certain key resonant delay effects created with short repeat times.

 Only operable when one of the first three settings of the Rhythm menu are selected (None, 64th triplet, or 64th). For example, you can use it to adjust a short Rhythm setting, and then switch to a longer setting via GE RT Parameter control, and the offset will be ignored, allowing the longer rhythms to stay in sync.

**Repetitions** [0...100, 101:∞]

The maximum number of repeated notes to generate. Note that due to other settings and circumstances, not all of them may actually be generated. A setting of **101: ∞** causes the notes to repeat indefinitely, unless something else stops them.

**Decay** [-126...+126]

The amount by which each successive repeated note changes in velocity. **Negative numbers** cause the delayed notes to decrease in volume (more common), while **positive numbers** cause the delayed notes to increase in volume. Interesting effects can be created by a combination of a **high negative** "Initial Velocity" (i.e. **-120**) and a **small positive** "Decay" (i.e. **+4**). Note that this operates in conjunction with the Velocity Pattern specified in the Velocity Group.

**Initial Velocity** [-126...+126]

The velocity above or below the original note that the first repeated note is generated at, after which the "Decay" parameter is added to them with each successive repetition. Note that this operates in conjunction with the Velocity Pattern specified in the Velocity Group.

**Transpose** [-24...25]

- |                                |
|--------------------------------|
| -24...24: -24...+24 semi-tones |
| 25: Index Pattern              |

The amount by which each successive repeated note is transposed in pitch. When one of the semitone values is selected, the same value is used for each repeated note. When the Pattern option is selected, the **25: Index Pattern** in the Index Group is used, so that each repeated note can transpose a different amount from the previous repeated note. Depending on the input notes, anything other than 0 or multiples of 12 may produce atonal results; these can be shifted to tonal results using "Chord Shift," described below.

**Chord Shift** [0...2]

- |        |           |            |
|--------|-----------|------------|
| 0: Off | 1: Scalic | 2: Scalic2 |
|--------|-----------|------------|

When repeated notes are being transposed in pitch, atonal results may occur depending on the "Transpose" setting. When "Chord Shift" is **0: Off**, no change occurs in the transposition. Setting "Chord Shift" to **1: Scalic** or **2: Scalic2** causes chord recognition algorithms to shift the notes to musically correct ones, even in pending repeated notes that haven't yet sounded.

Even when the Transpose setting is **0**, this can be used to make the pending repeated notes conform to the new chord, which is impossible with outboard analog/digital delays. For example, if "Chord Shift" is **0: Off** and you strike a BMaj chord which will repeat 10 times, and then play a C Major chord before they have

all repeated, the still to be generated repeats will be BMaj repeats overlapping CMaj repeats (dissonant). With “Chord Shift” is **1: On**, the still to be generated repeats will shift to the new chord and blend with the new repeats.

**Note:** A certain area of the keyboard may need to be assigned as a Control Area for Chord Scan (in the Dynamic MIDI) to produce the desired results.

#### 0: Off

The transposed notes are repeated with no further modification from this setting.

#### 1: Scalic

As the notes are repeated, notes which may be “atonal” based on the analyzed chord (due to being transposed) are shifted to tonal notes. Especially useful when “Transpose” (discussed above) is set to something other than **0** or multiples of **12**. The note tables used to shift the notes have fewer passing tones than **2: Scalic2** (described below), and therefore may produce results that are more pleasing.

#### 2: Scalic2

Same as **1: Scalic** (above), except that the note tables used to shift the notes have more passing tones for each chord; therefore, **2: Scalic2** sounds more modal in nature.

### Stop Mode

[0...3]

0: Off

1: Any-Any Note

2: AKR-1st Note After Key Release

Allows pending repeated notes which haven’t sounded yet to be discarded (stopped) by various actions, such as playing the keyboard.

#### 0: Off

Playing new chords or notes do not affect pending repeated notes - they will continue repeating as the parameters specify. This allows previously started repeats to overlap newly started repeats.

#### 1: Any-Any Note

Playing any new chords or notes will cause all pending repeated notes to be discarded, and only the new notes will be repeated.

#### 2: AKR-1st Note After Key Release

Playing any new notes while still sustaining at least one note will not cause damping; all keys must first be released, and then the next chord/note will discard any pending repeated notes.

**Note:** A MIDI Controller can also be assigned to perform the stopping of repeats by using the “Repeat Stop” Dynamic MIDI Destination. When a Dynamic MIDI destination (7–7: Dynamic MIDI “Destination”) is set to “Trigger Notes” or “Trigger Notes & Envs,” Stop Mode also applies to whether the repeats will be stopped when triggered by the Dynamic MIDI action.

### Rebound Mode

[0...2]

0: Off

1: Wrap

2: Rebound

When using “Transpose” (p.1064) with repeated notes and many repetitions, eventually the pitches of the repeated notes may go beyond a certain range. This

can be an absolute overall range, or a small range designed to track the hands around the keyboard. The range and functioning of it is determined by the settings of the “Range Mode” and “Range Bottom/Top” parameters described below. When the pitches of the repeated notes goes beyond this range, the “Rebound Mode” setting determines whether the repeats will end or continue in a modified fashion.

#### 0: Off

When repeated notes go beyond the specified range, they will cease to repeat, regardless of the number of repetitions left.

#### 1: Wrap

When repeated notes go beyond the specified range, they will drop up or down an algorithmically determined interval (depending on which end of the range they exceed) and continue until the required number of repetitions have been generated. This will cause an up/down back-and-forth “cycling” effect at the top or bottom of the range.

#### 2: Rebound

When repeated notes go beyond the specified range, they will reverse their direction (essentially by inverting the current Transpose values) and continue in the opposite direction until the required number of repetitions have been generated. This will cause an up/down back-and-forth “cycling” effect over the entire range.

### Tempo Env. Lock

[0, 1]

0: Off

1: Lock

When a Tempo Envelope is being used (in the Envelope Group), setting this to **1: Lock** causes the repeated notes to lock their size to the Tempo Envelope; i.e. as the Tempo Envelope speeds up the times between them get smaller. Setting this to **0: Off** causes the size to remain relative to the KARMA Tempo; even though the Tempo Envelope may be speeding up or slowing down the effect, the repeat times remain the same.



When a Tempo Envelope is **0: Off** or not in use, this parameter has no effect.

## Range Parameters

These parameters affect the pitch range of the repeating notes as they transpose, and what happens when they go outside of the range. They also control a range for triggering by velocity.

### Range Mode [0...3]

- 0: Absolute
- 1: Lowest Note Relative
- 2: Highest Note Relative
- 3: Lowest/Highest Note Relative

Selects one of several options for how the “Wrap Bottom” and “Wrap Top” values are used, which specify a range within which repeated notes will be maintained. This can be either an “absolute range,” or a “sliding range” that tracks your hands around the keyboard. When notes go beyond this range, they will either stop repeating, wrap around or rebound, as determined by the “Rebound” setting.

#### 0: Absolute

The “Range Bottom (abs)” and “Range Top (abs)” parameters are used, specifying Note Number values for the absolute bottom and top of the pitch range for repeated notes. For example, **36** is C2 and **72** is C5.

#### 1: Lowest Note Relative

The “Range Bottom (rel)” and “Range Top (rel)” parameters are used, defining a “sliding range” with regards to the lowest note played, represented as +/- semitones. For example, if you set bottom to **-12** and top to **+12**, this means that the notes will be kept in range from an octave below the lowest note played to an octave above the lowest note played.

#### 2: Highest Note Relative

The same as above, but relates to the highest note played.

#### 3: Lowest/Highest Note Relative

The “Range Bottom (rel)” parameter relates to the lowest note played, and the “Range Top (rel)” parameter relates to the highest note played. Therefore, you control the overall range according to the spread of the notes that are played. For example, if you set both the bottom and top to **0** in this mode, then repeated notes would never be generated outside of the range of the lowest to highest note that were provided as input.

### Range Bottom (Abs) [0...127: C-1...G7]

### Range Top (Abs) [0...127: C-1...G7]

Specifies an absolute pitch range within which to keep repeated notes that are being transposed. The Bottom and Top values are Note Numbers in the range 0–127/C-1–G7. When the pitches of repeated notes exceed this range, the setting of the “Rebound” parameter comes into effect.

**Note:** These settings are only effective when the “Range Mode” parameter is **0: Absolute**.

### Range Bottom (Rel) [-64...+63 semitones]

### Range Top (Rel) [-64...+63 semitones]

Specifies a relative (sliding) pitch range within which to keep repeated notes that are being transposed, based on the position of input notes played on the keyboard. The Bottom and Top values are semitone offsets in the range **-64**–**+63**. When the pitches of repeated notes exceed this range, the setting of the “Rebound” parameter comes into effect.

**Note:** These settings only have an effect when the “Range Mode” parameter is one of the 1.3: Relative settings.

### Vel. Range Bottom [1...127]

### Vel. Range Top [1...127]

Specifies a Velocity Range for initiating the generation of repeated notes. Input notes with velocities outside of this range will not generate repeats.

When “GE Type” (Ⓢp.1023) is **3: Real-Time**, these specify a velocity range within which input notes will trigger the generation of repeated notes. Notes outside of the velocity range will not generate repeats. This is an easy way to allow the velocity with which you play to control the triggering of repeated notes.

When “GE Type” is any of the other options, these specify a velocity range within which generated notes (such as notes from the Note Series, or Drum Pattern notes) will trigger the generation of repeated notes. Notes outside of the velocity range will not generate repeats. This allows only certain notes within certain velocity ranges to trigger the generation of repeated notes, while others will not.

- 🚫 Repeats can not be generated when “GE Type” (Ⓢp.1023) = **1: Generated-Gated** and “Gate Type” (Ⓢp.1023) is one of the CC Types, since notes are not actually generated in this mode, but a sustained set of notes is manipulated by a selected CC, i.e. “chopped” by **CC#11 (Expression)**.

## GE Mode = Real-Time Parameters

If the “GE Type” is **3: Real-Time**, these additional parameters are also available.

### Duration Mode (RT)

[0...4]

- 0: As Played
- 1: Fixed
- 2: As Played-No Overlap
- 3: Fixed-No Overlap
- 4: As Played-Delay No Overlap

Chooses one of 5 different modes for the durations of the repeated notes, which not only can greatly reduce problems with polyphony, but also provide some interesting performance options.

#### 0: As Played

Each delayed note will have the same duration as the initial note, with the exception that if “Transpose” (p.1064) is 0, then notes of the same pitch will not overlap. If “Transpose” is other than 0, and many notes are sustained, this can quickly eat up a lot of the polyphony of your sound modules.

#### 1: Fixed

The original note will have the duration as played, but each repetition will have a fixed length, set by the “Duration Value (RT)” parameter, in milliseconds. This can be used so that holding long notes will have repeated notes with short durations, saving polyphony or creating useful effects.

#### 2: As Played-No Overlap

If the original note is shorter than the repeat time, each delayed note will have the same duration as the initial note. If the original note is longer than the repeat time, it will be cut-off by the first repeat, and each repeat will cut-off the preceding one. Therefore, all notes including the original one will not have a duration longer than the repeat time.

#### 3: Fixed-No Overlap

If the original note is longer than the repeat time, it will be cut-off by the first repeated note. Furthermore, each repeated note will have a fixed value in milliseconds, set by the “Duration Value (RT)” parameter.

#### 4: As Played-Delay No Overlap

The original note will have the duration as played, and so will the delays, as long as they are shorter than the repeat time. If the original note is longer than the repeat time, it will not get cut-off, but the delays will limit their lengths to the repeat time.

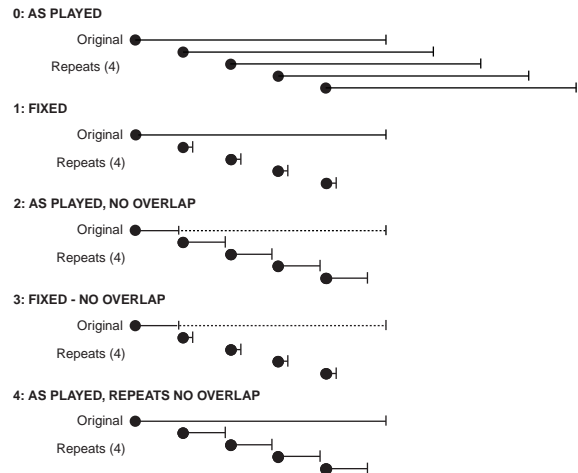

### Duration Value (RT)

[2...5000 (ms)]

Specifies the length of the durations of the repeated notes (in milliseconds).



Only available when the “Duration Mode (RT)” is **1: Fixed** or **3: Fixed-No Overlap**.

### Key Mode (RT)

[0, 1]

- 0: Down
- 1: Up

Selects whether the repeated notes start immediately upon receiving a “key down” event, or wait until notes are released (“key up”).

#### 0: Down (Key down)

Generation of the repeated notes starts immediately upon receiving a note according to the settings of the parameters.

#### 1: Up (Key up)

Generation of the repeated notes is not started until the input source note(s) are released. This allows you to trigger the start of a repeated effect with the release of the keys.

### Chord Quantize (RT)

[0, 1]

- 0: Off
- 1: On

Causes one of two different types of behavior, depending on the setting of the “Key Mode (RT)” parameter above.

#### When “Key Mode (RT)” is 0: Down

When a chord is played on the keyboard, there is a certain amount of “slop” associated with hitting the keys: the fingers arrive at slightly different times, there is a built in amount of MIDI timing inaccuracy, etc. When using **Melodic Repeat** to repeat the chord a number of times, you will hear the same slop it was received with repeated exactly. This corresponds to the “Chord Quantize (RT)” setting of **0: Off**. This may or

may not be desirable; sometimes you may want it, other times you may not. When “Chord Quantize (RT)” is set to **1: On**, the notes in the first repeat of the chord will be hard quantized so that they generate simultaneously. All subsequent repeats will be based on those quantized notes, and therefore will also be quantized.

### **When “Key Mode (RT)” is 1: Up**

The repeats will be triggered when the key(s) are released, so they will be quantized together at that point to occur simultaneously anyway, with no “slop.” But depending where you released them overall in time, they may be “out of sync” with the rhythm or groove that may be being generated. This corresponds to the “Chord Quantize (RT)” setting of **0: Off**. When “Chord Quantize (RT)” is set to **1: On**, the release (and generation of the first repeats) will be quantized to correspond to the nearest rhythmic division of note generation. This will either be a 16th note, or the rhythm value chosen in the “Rhythm Value” parameter, whichever is longer.



# Bend Group

## Overview

The **Bend Group** allows various shapes of automatic pitch bending to be applied to individual notes as they are generated. It also allows a special “arpeggiated bending” option to be applied to Drum Patterns.

However, no bending will actually occur unless the Phase Pattern has been configured to allow it. This allows effects to be set up where bending only occurs in one or more steps of the Phase Pattern, while other steps have no bending.

Bending is also affected by the Rhythm Pattern’s “no bend” row. Bending will normally be triggered with every single generated note or cluster within a Phase

Pattern step where bending is activated; by using the “no bend” row, you can specify that bends will not occur on various notes (single steps) of the Rhythm Pattern. For more information, see Rhythm Group: “Pattern Grid & Associated Parameters” on page 1036.

Note that even if bending is properly activated, you may not be hearing any bending effects if the 7–2b: Transmitted MIDI Filter: “Pitch Bend” parameter (PG p.111) has been set to filter out the pitch bend that KARMA is generating.

## General Parameters

### On/Off

[0, 1]

0: Off      1: On

Allows the bending effects to be turned on or off. While there are several other ways to disable bending effects, this is mainly provided to allow the RT Parm to control this in real-time. Note that this has no effect if there are no Phase Pattern Steps with bending enabled, or every step of the Rhythm Pattern has a “no bend” row activated.

### Amount

[-12...18]

0: Random	15: Next Note +2
-12...12: -12...+12 semitones	16: Prev Note
13: Next Note	17: Prev Note -1
14: Next Note +1	18: Prev Note -2

Sets the size in semitones of the bends, or selects one of several special bending options. Note that the actual resulting size of the bend also depends on the setting of the “Bend Range” parameter, described later on. The following descriptions apply when the “Bend Range” (PG p.1071) value is 12 (an octave). If the “Bend Range” was 6, the semitones would actually be half-semitones; if the “Bend Range” was 24, the semitones would actually be whole tones.

#### 0: Random (-12...12)

Each bend selects a random semitone size from -12–12 (excluding 0).

#### -12...12: -12...+12 semitones

Bends each note the selected semitone size.

#### 13: Next Note

Bends each note to what will be the next note. For example, if the notes to be generated were {C, E, G, B, C...}, then the C will bend to the E, the E will bend to the G, etc. This is very useful for simulation of portamento, or effects like sliding from one bass note to another within a phrase.

#### 14: Next Note +1

Bends each note to what will be the note 2 notes from the current note. For example, if the notes to be generated were {C, E, G, B, C...}, then the C will bend to the G, the E will bend to the B, etc.

#### 15: Next Note +2

Bends each note to what will be the note 3 notes from the current note. For example, if the notes to be generated were {C, E, G, B, C...}, then the C will bend to the B, the E will bend to the second C, etc.

#### 16: Prev Note

Bends each note to what was the previous note. For example, if the notes to be generated were {C, E, G, B, C...}, then the E would bend to the C, the G would bend to the E, the B would bend to the G, etc. In this case, if C was the first note to be generated, a bend to E would be calculated since there is no actual “previous” note.

#### 17: Prev Note -1

Bends each note to the note that was two notes previous. For example, if the notes to be generated were {C, E, G, B, C...}, then the G will bend to the C, the B will bend to the E, etc.

#### 18: Prev Note -2

Bends each note to the note that was three notes previous. For example, if the notes to be generated were {C, E, G, B, C...}, then the B will bend to the C, the second C will bend to the E, etc.

For the 3 Previous Note settings, when no notes have yet been played, KARMA extrapolates what it thinks the bends would have been for the first few notes, based on various settings. Most of the time this will produce a “musical-sounding” bend.

For the Next and Previous Note settings, a bend of 0 is not allowed, even if the next or previous notes to be generated are the same pitch. In this case, a bend to the next or previous note in the Note Series will be used, in order to preserve the illusion of continuous bending. If all possibilities are exhausted, a bend of an octave (12) will be used.

 **13, 14, 15, 17 & 18** not available when “GE Type” (“GE Type” on page 1023) is **3: Real-Time**.

**Force Bend If Zero** [0, 1]

0: Off      1: On

When using next or previous note bending, if the two pitches to be bent between are adjacent, a bend of zero can result (no bend). When Force Bend If Zero is **1: On**, a bend will be created anyway, with an appropriate automatically calculated amount. This allows each note to have an audible bend, even if it technically shouldn't, thereby maintaining an illusion of continuous bending (useful for synth bass lines, for example). When **0: Off**, no bends will be created between notes of the same pitch (useful for acoustic and electric bass lines, for example).

 Not available unless Amount is set to one of the Next or Previous Note settings.

**Shape** [0...2]

0: Bend      1: Hammer      2: Hammer Bend

Selects one of Three different overall shapes for the resulting bend. **0: Bend** is a single bend to a destination pitch, while the “Hammer” settings bend to the pitch and back. See the Appendices: “Using Auto Bend”. (p.1084)

**0: Bend**

Bends the current note to whichever note or by whichever semitone size is selected in the “Amount” parameter. The timing and length of the bend is determined by the “Length,” “Start %” and “End %” parameters. (p.1070) Useful for portamento simulation and ethnic bending effects, among others.

**1: Hammer**

Bends the current note to whichever note or by whichever semitone size is selected in the “Amount” parameter, then back to the current pitch. The timing and length of the bend is determined by the “Length,” “Start %” and “End %” parameters, and the “Width %” parameter. Useful for guitar hammer-on effects, among others.

**2: Hammer Bend**

Bends the current note to whichever note or by whichever semitone size is selected in the “Amount” parameter (p.1069), then back to the current pitch, then again to the note or pitch selected in the “Amount” parameter. The timing and length of the bend is determined by the “Length,” “Start %” and “End %” parameters, and the “Width %” parameter. Useful for ethnic bending effects, among others.

**Alternation** [0, 1]

0: Off      1: Alternating

When set to **1: Alternating**, causes alternate bends to flip back and forth between the + and -. For example, if the “Amount” parameter is set to **+12**, then the bends produced with a series of notes will be {+12, -12, +12, -12...} etc. When **Next/Previous Note** Bending is selected, it will alternate between Next and Previous.

For example, if **13: Next Note** is selected in the size Menu, then the bends will be {**Next, Prev, Next, Prev...**} etc.

**Step Mode** [0...12]

0: Smooth      1...12: 1 ST...12 ST

Sets whether the bends will be smooth (continuous) or divided into steps (glissando bends).

**0: Smooth**

Bends will be continuous, with a value sent out every “n” milliseconds as specified by the Rate parameter.

**1...12: 1 ST...12 ST (semitones)**

Bends will be quantized to the semitone step size selected, producing “glissando” bends. For example, if the “Amount” parameter is set to **12** and Step Mode is set to **2: 2 ST**, then the resulting bend will be **quantized to 6 steps of 2 semitones** each (a Whole tone scale.)

When one of the Semitone settings is selected, the Rate parameter is not available.

**Length** [0...25]

0: 64th triplet	9: 8th triplet	18: Whole triplet
1: 64th	10: 8th	19: Whole
2: 64th Dotted	11: 8th Dotted	20: Whole Dotted
3: 32th triplet	12: Quarter triplet	21: 2 bars
4: 32th	13: Quarter	22: 3 bars
5: 32th Dotted	14: Quarter Dotted	23: 4 bars
6: 16th triplet	15: Half triplet	24: Fixed-ms
7: 16th	16: Half	25: Note Duration
8: 16th Dotted	17: Half Dotted	

Specifies an overall length for a “**bend window**” within which the bend will take place, based on the “Start %” and “End %” parameters. See the Appendices: “Using Auto Bend”. (p.1084)

**0...23: Note values**

Sets the overall length of each bend window to the selected rhythm value; each bend will therefore be the same length. Note that this is tempo dependent, so changing tempo changes the length of the bend and keeps the effect locked to tempo. If the length of the bend is longer than the actual duration of the note with which it is generated, part or all of the bend will not be heard.

**24: Fixed-ms**

Makes available the “Fixed-ms” parameter. A length of absolute time may then be specified in milliseconds for each bend window. Note that this is independent of any tempo settings. You might use this to keep the same length and speed of a bend regardless of the tempo.

**25: Note Duration**

The duration of the note as it is generated is used as the bend window, with the “Start %” and “End %” parameters specifying where in the note’s duration the bend will start and end. Each bend may therefore be a different length, depending on the durations of the notes. A 16th note duration will have a bend that is half the length and twice as fast as an 8th note duration. If the duration is varied in real-time, the length of the bends will also be varied.

⚠ Not available when “GE Type” (p.1023) is **3: Real-Time**, since the duration of the note is determined by actually playing the keyboard. If selected, this setting will act the same as **7: 16th** note.

**Fixed-ms [10...5000 (ms)]**

A fixed length of absolute time may be specified in milliseconds for each bend window. Note that this is independent of any tempo settings. You might use this to keep the same length and speed of a bend regardless of the tempo. Has no effect unless the **24: Fixed-ms** setting is selected for the “Length” parameter

**Start % [0...100 (%)]**

Specifies the start point of the bend in the overall bend window (set by the “Length” parameter). The value is a percentage of the overall bend window. For example, if **0%**, the bend will start as soon as the note begins to play; other values will cause a certain “delay” before the start of the bend.

**End % [0...100 (%)]**

Specifies the end point of the bend in the overall bend window (set by the “Length” parameter). The value is a percentage of the overall bend window. For example, if **100%**, the bend will extend all the way to the end of the bend window; other values will cause the bend to reach the destination pitch and “hang there” for a period of time.

**Width % [0...100 (%)]**

Specifies the width of the “hammer” when the **1: Hammer** or **2: Hammer Bend** shape is selected. This controls the amount of bend at each end of the hammer (the “back-and-forth” bend). For example, **0%** creates a triangle wave shape, and **100%** creates a square wave shape, with other values somewhere in between. Width also controls the length of the final bend when the Hammer Bend shape is selected. See the Appendices: “Using Auto Bend.” (p.1084)

⚠ Has no effect when **0: Bend** is selected in the “Shape” parameter.

**Drum Bend Mode [0, 1]**

0: Generated 1: Arpeggiated

Selects one of two different bending techniques for Drum GEs: “Generated” according to the parameters on this Group, or “Arpeggiated” using the current Note Series settings.

**Note:** If the “GE Type” (p.1023) is **2: Generated-Drum**, the “Drum Bend Mode” parameter specifies one of two different bending effects:

**0: Generated-generate shape for each note**  
Causes bending to be generated for each drum note the same as with any other “GE Type”. All of the parameters described above operate as described.

**1: Arpeggiated-use Note Series for stepped bends**  
Disables most of the other bend parameters, and instead uses the pitches of the notes in the Note Series to generate stepped “pitch bend sequences.” The riff or arpeggio that would normally be being produced if the “GE Type” was **0: Generated-Riff** is still being generated internally, even though the Drum Pattern(s) are being played. This internal riff or arpeggio can be applied to the resulting drum rhythms as Pitch Bend values. The Index Pattern controls the order of the pitch bend values, which are selected from within the Note Series, just as if the “GE Type” was **0: Generated-Riff**. This results in “Wave-Sequencing” effects and other unique sounds.

⚠ Not available when “GE Type” is not **2: Generated-Drum**.

**Bend Range [0...24 (semitones)]**

Sets the overall bending range of the whole GE. This also affects pitch bend envelopes, CC-A/CC-B if generating pitch bend, etc. Note that this must be set to **12** for the semitone-related bend parameters described above to actually be semitones.

**GE Mode = Real-Time Parameters**

If the “GE Type” is **3: Real-Time**, the following parameters will also be available.

**Key Mode (RT) [0, 1]**

0: Down 1: Up

Selects whether the bend will be initiated when the keys are pressed (MIDI note-ons are received) or when the keys are released (MIDI note-offs are received).

**0: Down**

The bend window specified by the “Length” (p.1070) setting starts immediately upon receiving a note according to the settings of the parameters.

**1: Up**

The bend window is not started until the input source note is released. Note that for this kind of bend effect to be audible, you must either be using a synth program with a long release, or set the “Rel. Delay Length (RT)” parameter below to something other than **0: Off**.

**Direction (RT) [0, 1]**

0: From 1: To

Selects whether the pitch is bent from the note to the destination (**1: To**) or from the destination to the note (**0: From**.) This most often relates to which Bend Shape is selected.

**0: From**

The bend starts at a pitch offset equal to the Amount setting, and ends at the current pitch (i.e. Joystick center). For example, if “Amount” = **-12** and “Shape” = **0: Bend**, it would be the same as starting a note with the Joystick all the way in the pitch down position, and then moving it to the center.

**1: To**

The bend starts at the current pitch (i.e. Joystick center), and ends at a pitch offset equal to the Amount setting. For example, if “Amount” = **-12** and “Shape” =

**0: Bend**, it would be the same as starting a note with the Joystick in the center position, and then moving it all the way to the pitch down position.

For more information on practical uses for this, see the Appendices “Using Auto Bend: Next/Previous Note Bending: Realtime.” (p.1084)

**Rel. Delay Length (RT) [0...24]**

0: 64th triplet	9: 8th triplet	18: Whole triplet
1: 64th	10: 8th	19: Whole
2: 64th Dotted	11: 8th Dotted	20: Whole Dotted
3: 32th triplet	12: Quarter triplet	21: 2 bars
4: 32th	13: Quarter	22: 3 bars
5: 32th Dotted	14: Quarter Dotted	23: 4 bars
6: 16th triplet	15: Half triplet	24: Off
7: 16th	16: Half	
8: 16th Dotted	17: Half Dotted	

Allows the release (note-offs) of notes to be delayed by certain amounts (various rhythmic durations at the current tempo). This is mainly to allow bends to be produced when you release the keys (with “Key Mode (RT)” set to **1: Up**). When **24: Off**, no delay is added.

**Rel. Delay Damping (RT) [0, 1]**

0: Off	1: On
--------	-------

When **1: On**, starting new notes while others are still sustaining (because of a delayed note-off from the “Rel. Delay Length (RT)” parameter above) will shut the sustaining notes off. This is useful for creating monophonic style bending effects using “Key Mode (RT)” and “Rel. Delay Length (RT)”. When **0: Off**, the notes are allowed to overlap.

**Vel. Range Bottom (RT) [1...127]****Vel. Range Top (RT) [1...127]**

Specifies a Velocity Range for triggering the generation of pitch bend effects. Input notes with velocities outside of this range will not trigger the bending. This is an easy way to allow the velocity with which you play to control the triggering of pitch bending effects.

## Drum Group

### Overview

The **Drum Group** allows up to three different **Drum** or **Melodic Patterns** (of equal or different lengths) to be created, edited, and simultaneously looped, while being separately modified by various other parameters. Many of these modifications are

controlled by settings in the Phase Group. This allows you to set up effects where various things happen only on certain steps of the Phase Pattern; such as a four bar Drum Pattern which is randomized with a Cluster Pattern every fourth time through (bars 13–16).

### About Drum Patterns

A Drum Pattern is a special type of “fixed” pattern that contains Note Numbers. These can be used to construct Drum and Percussion Patterns, or Melodic Patterns of a more fixed nature than what is generated by using the Note Series Group. Although you can create Drum Patterns with any mixture of notes you desire, a basic concept used throughout the available GEs was to have the three patterns (and three Drum Template Banks) follow these basic rules:

Pattern 1/Bank 1: Kick, Snare, and Tom Notes

Pattern 2/Bank 2: Hi-Hat, Ride, and Cymbal Notes

Pattern 3/Bank 3: Percussion Notes

This allows you to mix and match Kick/Snare Patterns with different Hi-Hat Patterns and Percussion Patterns, allowing great flexibility and variation.

Drum Patterns with more than one sound turned on in a column can operate either “polyphonically” (generating more than one drum note at a time) or as random “pools,” where a random choice will be made from one of the drum sounds in the column. The bottom row of each grid allows a rest to be placed as a step, or added to the pools for the possibility of a rest.

A Drum Pattern consists of only Note Numbers and rests; there are no durations, no velocities, no rhythms. The other information is supplied by the Rhythm, Velocity, Cluster, and other Patterns. It helps to think in terms of straight 16ths (or 32nds) while constructing new patterns. You can of course later play the Drum Patterns with Rhythm Patterns different values, for more variations.

A Drum Pattern will loop as long as note generation continues. The 3 separate Patterns are independently loopable, so they can be of different lengths; a 4 bar

Kick/Snare Pattern can be used with a 2 bar Hi-hat Pattern and a 3 bar Percussion Pattern, etc. They normally will not reset to the beginning of the Pattern unless a new Trigger is received, or unless the Phase Pattern has been configured to restart them at the beginning of certain Phases. This also means that a sixty-four step Drum Pattern can be looping while an eight step Velocity Pattern and a twelve step Cluster Pattern are also independently looping, for example.

The riff or arpeggio that would normally be being produced if the “GE Type” (ESP.1023) was **0: Generated-Riff** is still being generated internally. Therefore, if Index Patterns, Cluster Patterns, or Velocity Patterns are being used by the GE, these can be applied to the Drum Patterns with very interesting results, causing randomization and quasi-improvisational effects. The GEs included in the KRONOS make use of this effect in the Drum RTC Model, on the “Randomize/Improvise” slider.

These randomizations are controlled by settings in the Phase Pattern. This allows effects where various things happen only on certain steps of the Phase Pattern; such as a four bar Drum Pattern which is randomized with a Velocity Pattern every fourth time through (bars 13–16).

Also, the same riff or arpeggio can be applied to the resulting drum rhythms as Pitch Bend values, on the Bend Group. This results in “Wave-Sequencing” effects and other unique sounds. The included GEs use this feature in the Drum RTC Model on Switch 6. Each step in the Phase Pattern can have Pitch Bend activated for that particular step. This means that you can do something like have no Pitch Bend through three steps and then have Pitch Bend on the fourth step.

### Pattern Editing Grid & Associated Parameters



#### Drum Pattern

A Drum Pattern is a grid of 8 rows by 64 columns. The bottom row of the grid is the “Rest” row; the other 7 rows correspond to 7 Drum Sounds or Notes that have been chosen to construct the pattern. A Drum Pattern

may have any number of steps up to 64, with each step being represented by one column on the grid; unused columns appear disabled.

The example above shows a kick, snare, toms and maracas pattern, where the bottom two rows in the top part of the grid have their corresponding Drum Sound menus set to kick and snare. The bottom row of rests is interleaved with the kick and snare choices to form a groove to be played with a straight 32nd note Rhythm Pattern. Therefore, the entire grid represents a 2 bar phrase of 4/4 time, with every 8 columns representing 8 32nd notes (1 quarter note).



Also shown above is a 65th column, known as the “Always Column” and indicated by the abbreviation “a” underneath it. When a row is selected in this column, it will cause any values in that row of the

Drum Pattern to always be played, regardless of any randomization that is going on, or regardless of the “Poly/Pools” setting (discussed later on).

 Pattern grids cannot be viewed or edited on the KRONOS.

## Associated Parameters

### Play On/Off [0, 1]

0: Off      1: On

When **1: On**, the Drum Pattern is played during Note Generation. When **0: Off**, the Grid may contain values but will not be played during Note Generation. This can be used to temporarily “mute” one or more patterns during playback.

### On/Off Combinations [0...7]

Controls all 3 Drum Pattern On/Off at the same time, in various combinations. The values 0–7 select one of 8 different combinations, shown in the following table:

Value	Pattern 1	Pattern 2	Pattern 3
0	Off	Off	Off
1	On	Off	Off
2	Off	On	Off
3	Off	Off	On
4	On	On	Off
5	Off	On	On
6	On	Off	On
7	On	On	On

### Row1...7 Note [0...127]

0...127: C-1...G9

Selects a Drum Sound/MIDI Note Number for each of the 7 rows of the selected Drum pattern.

### Row1...7 Vel. Offset [-127...+127]

Allows the velocity for notes from that row only to be offset with regards to other rows. For example, you can use this to make a snare softer overall than a kick. Note that this is subtractive/additive: “0” leaves velocities at the Initial Velocity they would normally be generated with based on the Velocity Group settings. So setting positive amounts may interfere with the Velocity control that you have specified elsewhere. One example is controlling the velocity sensitivity of the Drum Pattern with the keyboard. Regardless of your Velocity Group settings, if the Row Velocity Offset here was a large positive value, you would get no apparent velocity sensitivity from the keyboard for this row, since this value would be added and effectively cancel out the effects of the Velocity Mode and Value.

### Rhythm Multiplier [1...800 (%)]

Multiplies the current Rhythm Pattern. Note that this is entirely independent of the same parameter in the Rhythm Group. This means that each Drum Pattern can have a different “Rhythm Multiplier.” (see p.1038) For example, if you set the Rhythm Pattern to 32nds, you could drive one Drum Pattern with a “Rhythm Multiplier” of 100% at 32nd note speed, and another

Drum Pattern at 200% for 16th note speed. If they were the same number of steps, it would take twice as long to perform the entire 16th-based pattern as the 32nd-based pattern. This also means that the Rhythm Pattern driving the underlying Riff (that may be applied as Pitch Bend or used to randomize the Drum Patterns) can be operating at a different rhythmic relationship. For example, if the Rhythm Pattern was set to 16ths, and the Drum Pattern “Rhythm Multiplier” to 50%, the Drum Pattern would be generated as 32nd-based, while any arpeggiated pitch bend would be 16th-note based, or 1 bend every 2 steps of the Drum Pattern.

### Straight Multipliers [0...5]

0: 25%      2: 100%      4: 200%  
1: 50%      3: 200%      5: 800%

Selects from a quantized set of “straight” values for the “Rhythm Multiplier” field of the associated Drum Pattern(s). In other words, when applied to a Rhythm pattern containing values such as 16th notes, the resulting rhythmic values will be straight values such as 8th notes, quarter notes, etc.

### Straight/Trip Mults [0...10]

0: 25%      3: 68%      6: 200%      9: 544%  
1: 34%      4: 100%      7: 272%      10: 800%  
2: 50%      5: 136%      8: 400%

Selects from a quantized set of “straight & triplet” values for the “Rhythm Multiplier” field of the associated Drum Pattern(s). In other words, when applied to a Rhythm pattern containing values such as 16th notes, the resulting rhythmic values will be straight values such as 8th notes, quarter notes, etc. or various triplet values.

### Strt/Dot/Trip Mults [0...15]

0: 25%      4: 68%      8: 150%      12: 400%  
1: 34%      5: 75%      9: 200%      13: 544%  
2: 37%      6: 100%      10: 272%      14: 600%  
3: 50%      7: 136%      11: 300%      15: 800%

Selects from a quantized set of “straight, triplet & dotted” values for the “Rhythm Multiplier” field of the associated Drum Pattern(s). In other words, when applied to a Rhythm pattern containing values such as 16th notes, the resulting rhythmic values will be straight values such as 8th notes, quarter notes, etc., various triplet values, or various dotted values.

### Pattern Vel. Offset [-127...+127]

Subtracts or adds a constant amount to the velocities for each Drum Pattern. Allows a Pattern’s relative volume to be raised or lowered with regard to the other Patterns. Note that this is subtractive/additive: 0

leaves velocities at the Initial Velocity they would normally be generated based on the Velocity Group settings.

Setting positive amounts may interfere with the Velocity control that you have specified elsewhere. One example is controlling the velocity sensitivity of the Drum Pattern with the keyboard. Regardless of your Velocity Group settings, if the Pattern Velocity Offset here was a large positive value, you would get no apparent velocity sensitivity from the keyboard, since this value would be added and effectively cancel out the effects of the Velocity Mode and Value.

**Pattern Vel. Scale [-999...+999 (%)]**

Specifies a percentage by which the Velocity Pattern selected in the Velocity Group is scaled before being used to generate notes from the Drum Pattern, if this feature has been assigned in the Phase Group. Notes can be made to disappear or drop out using large positive values; large negative values with a very soft Initial Velocity can create interesting “reversed” effects. The same field in the Velocity Group itself is disabled for Drum Effects, since each Pattern here has its own “Velocity Scale.”

**Pattern Transpose [-36...+36]**

Allows each Drum Pattern to be individually transposed in semitones. This is additive to the transpose in the KARMA Module. For more information, see “7–3: Module Parameters–Control” on page 112.

**Octave Transpose [-36...+36]**

Allows the Drum Pattern Transpose value to be quantized to the nearest octave, so that when being changed by a KARMA Realtime Control, only transposition by octaves is possible. In this case, the value of the parameter changes by semitones, but the actual transpose value will only change at certain points within the range:

- 36 to -31 = -36 (-3 octaves)
- 30 to -19 = -24 (-2 octaves)
- 18 to -7 = -12 (-1 octave)
- 6 to +5 = 0 (no transpose)

- +6 to +17 = +12 (+1 octave)
- +18 to +29 = +24 (+2 octaves)
- +30 to +36 = +36 (+3 octaves)

**Oct/5th Transpose [-36...+36]**

Allows the Drum Pattern Transpose value to be quantized to the nearest octave or fifth, so that when being changed by a KARMA Real-time Control, only transposition by octaves or fifths is possible. In this case, the value of the parameter changes by semitones, but the actual transpose value will only change at certain points within the range:

- 36 to -33 = -36 (-3 octaves)
- 32 to -27 = -29 (-3 octaves +5th)
- 26 to -21 = -24 (-2 octaves)
- 20 to -15 = -17 (-2 octaves +5th)
- 14 to -9 = -12 (-1 octave)
- 8 to -3 = -5 (-1 octave +5th)
- 2 to +3 = 0 (no transpose)
- +4 to +9 = +7 (+5th)
- +10 to +15 = +12 (+1 octave)
- +16 to +21 = +19 (+1 octave +5th)
- +22 to +27 = +24 (+2 octaves)
- +28 to +33 = +31 (+2 octaves +5th)
- +34 to +36 = +36 (+3 octaves)

**Note Series -> Length [0, 1]**

- 0: Off
- 1: On

When **1: On**, the Pattern uses the GE’s actual Note Series Length as the length of the Drum Pattern. For example, if the Note Series Group was set to “Replications” (p.1027) **4.0** with “Symmetry” (p.1027) **Off**, and 4 notes were played, a **16 note** Note Series would normally be created. The Drum Pattern would restart after **16 steps** if it have been played. Playing 1 note would change the Note Series Length to 4, and the Drum Pattern would restart after **4 steps**. This can be used to change the apparent length or time signature of the groove or phrase in real-time. When this is **0: Off**, the Drum Pattern loops through its full length.

**Random Weighting Parameters– Pools**

The Random Weighting Parameters - Pools are made available when at least one step (column) in the Drum Pattern Grid contains multiple buttons turned on in the upper 7 rows (not counting the “rest” row), and the “pools” button is on. This step then constitutes a “random pool” of Drum Sounds/Notes.

For example, you can influence whether a tom will be played at a certain step more often than a snare.

For more information, see “Rhythm Group” on page 1035, and “Random Weighting Parameters - Pools” on page 1037.

**Pools-Random Factor [-99...+99]**

For information on this parameter, see “Rhythm Group” on page 1035 and “Pools-Random Factor” on page 1037.

**Pools-Weighting Curve [0...3]**

- 0: Exponential
- 1: Logarithmic
- 2: Exp-S
- 3: Log-S

For more information, see “Pools-Weighting Curve” on page 1037, and “Rhythm Group” on page 1035.

See also “Appendices” on page 1084, and “Random Weighting Curves” on page 1086.

The following table summarizes the effect of the various Weighting Curves and the Factor field on Drum Sound choices:

Drum Pool values that receive priority:		
Weighting Curve	Factor	
		+ (positive)



Exp/Log	higher in grid	lower in grid
Exp-S/Log-S	middle	higher/lower

## Random Weighting Parameters– Rests

The Random Weighting Parameters - Rests are made available when at least one column in the grid has a rest and at least one other Drum Sound turned on. This will happen with either the **1: pool** or **2: poly** selected, since you can have random rests in both modes; they just operate differently (see the description under “Pools/Poly,” below).

Whenever this step is encountered in playing through the pattern and a random choice must be made, the likelihood of a rest occurring can be favored by the use of a separate weighting curve.

### Rests-Random Factor [-99...+99]

Controls the degree of slope to the Weighting Curve. **0** = a **Linear Curve** with any Weighting Curve. Negative values not only invert but rotate the curve. For examples, see “Random Weighting Curves” on page 1086.

### Rests-Weighting Curve [0, 1]

0: Exponential                      1: Logarithmic

2 different shapes are available, which affect the likelihood of a rest occurring when a random choice is made. For more information, see “Random Weighting Curves” on page 1086.

### 0: Exponential

With a positive **Factor (+)**, choices will be exponentially weighted towards the Drum Sounds/Notes more often. With a negative **Factor (-)**, choices will be exponentially weighted towards the rests more often.

### 1: Logarithmic

With a positive **Factor (+)**, choices will be logarithmically weighted towards the Drum Sounds/Notes more often. With a negative **Factor (-)**, choices will be logarithmically weighted towards the rests more often.

 A Factor of **0** with any shaped curve yields a linear table (straight diagonal line), and each of the values in the pool will have an equal chance of getting chosen.

The following table summarizes the effect of the various Weighting Curves and the Factor field on random rests:

Values that receive priority:		
Weighting Curve	Factor	
	+ (positive)	- (negative)
Exp/Log	<b>less rests</b>	<b>more rests</b>

## Associated Parameters

### Pools/Poly [0, 1]

0: Poly                                      1: Pools

Chooses one of 2 modes of operation for the entire grid when columns contain more than one Drum Sound and/or a rest.

#### 0: Poly

If there is more than one Drum Sound selected in a column (and no rest), then all of the Drum Sounds at that step will be played; if you had a kick, snare, and hi-hat in the same column, all 3 would be played when that step was reached. This is the typical operation of most grid-based rhythm pattern software. However, if a rest is also selected, then there will be a random possibility of a rest or a Drum Sound for each of the Drum Sounds; in other words, if you had a kick, snare, hi-hat and rest in the same column, for each of the 3 Drum Sounds a choice between the sound and the rest would be made (subject to the Random Rest Weighting Curve described previously). This would result in one of 8 possible combinations:

- kick, snare, hi-hat                      → kick, snare, hi-hat
- (rest), snare, hi-hat                      → snare, hi-hat
- kick, (rest), hi-hat                      → kick, hi-hat
- kick, snare, (rest)                      → kick, snare
- (rest), snare, (rest)                      → snare
- (rest), (rest), hi-hat                      → hi-hat
- kick, (rest), (rest)                      → kick

(rest), (rest), (rest)                      → rest (nothing)

#### 1: Pools

If there is more than one Drum Sound selected in a column, then those sounds form a “pool” of choices from which only one will be chosen at random. If a rest is also selected, then there will be a possibility of a rest or only one of the Drum Sounds. For example, if you had a kick, snare, hi-hat and rest in the same column, there would first be a choice of one of the 3 Drum Sounds (subject to the Random Pool Weighting Curve described previously), then a choice as to whether to play the single chosen Drum Sound or a rest (subject to the separate Random Rest Weighting Curve described previously). This would result in one 4 possible choices:

- kick
- snare
- hi-hat
- rest

### Keyboard Track [0, 1]

0: Off                                      1: On

Allows the Drum Pattern to track the input notes if desired, thereby changing keys depending on the chord. **0: Off** is normal for Drum Patterns while **1: On** is normal for Melodic Patterns.

**0: Off**

The Drum or Melodic Pattern is “fixed” - it doesn't matter what notes you play on the keyboard. The pattern will always produce the same pitches, according to the settings of the Drum Sound/Note settings. This is most typical for Drum Patterns.

**1: On**

The pitches of the notes generated “track” the lowest key played on the keyboard (or other input device), related to **C2 (MIDI Note #36)**. This is most useful for Melodic Patterns. In other words, when you play a **C2**, the pattern will be produced using the Note Numbers as specified by the Drum Sound/Note settings, and any other applicable parameters. If you then play an **E2**, the notes being generated will be transposed up by **4 steps**. Assuming the Notes that are assigned are in the **key of C**, this puts the resulting pattern in the **Key of E**. This is often useful in conjunction with the “NTT - Note Table Transposition” parameter, described next.

**Note:** The “Root Position” parameter (PG p.114) can be used to cause different inversions of the same chord to always transpose the notes as if the chord was played in root position.

**NTT On/Off (Note Table Transposition) [0, 1]**

0: Off 1: On

Mainly for use with Melodic Patterns, this allows the chords received to shift certain pitches in the Drum Pattern to notes that fit the analyzed chord. Often used in conjunction with Keyboard Track.

**0: Off**

The different chords played on the keyboard (or other input device) have no effect on the pitches of the notes.

**1: On**

The Chord Analysis is performed on the input chord, and certain pitches as they are generated may be shifted to other notes to fit the chord. This is useful in conjunction with the “Keyboard Track” parameter described above. If you have created a Melodic pattern that is being transposed, you can also have the tonality of the pattern shift to match different chords as you play them, similar to popular auto-accompaniment keyboards. In other words, you can write a pattern that plays a musical phrase in a major key, and have it change to a minor key when you play minor chords, automatically.

**Note:** The “Root Position” parameter (PG p.114) can be used to cause different inversions of the same chord to always transpose the notes as if the chord was played in root position.

**Link To Next [0, 1]**

0: Off 1: On

The 3 Drum Patterns can be linked together to form longer Drum Patterns; in this case, they do not play simultaneously, but “back-to-back.” Drum Pattern 1 can be linked to Drum Pattern 2. Drum Pattern 2 can be linked to Drum Pattern 3. If both Drum Pattern 1 and 2 are linked, then all 3 are linked. This can be used to create lengthy drum grooves or melodic phrases, have

drum kits change for parts of a phrase, have melodic patterns change to using different pitches or octaves, etc.

**Notes Played = Rows [0, 1]**

0: Off 1: On

**1: On**

The number of keys pressed on the keyboard determines which rows of the 3 Drum Patterns are played. If only one key is pressed, then only the notes indicated by the first row of the Drum Pattern (lowest row of the 7 rows specifying drum notes) are generated. If 3 keys are pressed, then only the notes specified by the lowest three rows are generated. This can be used to simulate the Korg Triton Arpeggiator setting “Fixed Tone Mode”: **Trigger As Played**.

**Wrap Bottom [0...127]**

**Wrap Top [0...127]**

0...127: C-1...G9

Sets an overall range within which notes from all 3 Drum Patterns will be limited. Notes going beyond the range will be transposed by however many octaves necessary to keep them within the specified range. This is mainly intended for use with melodic patterns that are being transposed by using the Keyboard Track feature.

**Repeat On/Off Pattern [0...2]**

Allows an individual Drum Pattern to have its Melodic Repeat settings in the Phase Pattern set to one of three states:

**0: Off**

Melodic Repeat will be turned off in each step of the Phase Pattern, for the specified Drum Pattern.

**1: On**

Melodic Repeat will be turned on in each step of the Phase Pattern, for the specified Drum Pattern.

**2: As Stored**

Melodic Repeat will be set to the internally stored settings of the GE, for each Phase Pattern Step. This means that repeats can be on in some steps, and off in others, such as just generating repeated notes in the last bar of a four bar pattern.

**Repeat On/Off Combs (Combinations) [0...8]**

Allows all three Drum Patterns to have their Melodic Repeat settings in the Phase Pattern controlled at the same time, in various combinations. This allows you to use a single RT Control (such as a slider in the Real-Time Controls Editor) to control all three Patterns at the same time. The values 0~8 select one of 9 different combinations, shown in the following table:

**Off**

Melodic Repeat will be turned off in each step of the Phase Pattern, for the specified Drum Patterns.

**On**

Melodic Repeat will be turned on in each step of the Phase Pattern, for the specified Drum Patterns.

**As Stored**

Melodic Repeat will be set to the internally stored settings of the GE, for each Phase Pattern Step. This means that repeats can be on in some steps, and off in others, such as just generating repeated notes in the last bar of a four bar pattern.

Value	Pattern 1	Pattern 2	Pattern 3
0	Off	Off	Off
1	On	Off	Off
2	Off	On	Off
3	Off	Off	On
4	On	On	Off
5	Off	On	On
6	On	Off	On
7	On	On	On
8	As Stored	As Stored	As Stored

**Resync Index Templates [-1: As Stored, 0...13]**

Controls the selection of one of 12 Resync Index Template settings, which apply different values to each step of the Resync Index Rows [ri] of the Phase Pattern, in the specified Drum Pattern's section of the Phase Pattern Drum Activity Grid. This causes the Drum Pattern's playback indexes to resynchronize at various steps of the Phase Pattern.

Index Pattern settings may be used to modify a specified Drum Pattern's playback, often with randomized results, according to settings in the Phase Group and Index Group. When doing so, the use of the Index Pattern can cause playback of the various steps of the Drum Pattern to skip around and play out of order, creating new variations, often with a "free-form" improvisational feel. While quite useful, this can often feel "too syncopated," as the pattern can become completely disconnected from its original placement.

However, as playback of the Phase Pattern enters a particular step, if the Resync Index button [ri] is On, then the selected Drum Pattern's playback index will be reset to the position that it normally would be in if it wasn't being modified by the application of the Index Pattern. This can "resynchronize" the Drum Pattern back to the downbeat every four beats, or every two beats, etc., while allowing it to then begin skipping around again.

As playback of the Phase Pattern enters a particular step, if the Resync Index button [ri] is Off, no resetting of the Drum Pattern's index is performed, and the generation of the Drum Pattern continues from wherever it may be.

The following table illustrates the various values loaded into the Phase Pattern when a Resync Index Template is loaded for a particular Drum Pattern:

Value	Phase Pattern Steps																
	1	2	3	4	5	6	7	8	9	10	11	12	13	14	15	16	
-1	as stored																as stored
0																	all off
1	x							x									every 8
2	x				x					x			x				every 4
3	x		x		x		x		x		x		x		x		every 2
4	x	x	x	x	x	x	x	x	x	x	x	x	x	x	x	x	every step
5	x	x			x	x			x	x			x	x			4 step 1
6	x			x	x			x	x			x	x			x	4 step 2
7	x	x		x	x	x			x	x	x		x	x		x	4 step 3
8	x	x	x		x	x	x		x	x	x		x	x	x		4 step 4
9	x						x						x				every 6
10	x			x			x			x			x			x	every 3
11	x	x		x	x		x	x		x	x		x	x		x	3 step 1
12	x		x	x		x	x		x	x		x	x		x	x	3 step 2
13	x	x	x	x	x	x	x	x	x	x	x	x	x	x	x	x	every step

-1: As Stored

The Resync Index settings for the specified Drum Pattern will be set to whatever values they are stored to internally in the GE. They could be all On or all Off, or any combination of On and Off.

0...4: Templates based on 2 and 4

5...8: Templates based on 2 and 4 (alternate)

9...13: Templates based on 3

The Resync Index settings for the specified Drum Pattern will be set to one of the various patterns of On and Off values, causing the Drum Pattern playback indexes to resynchronize at various steps of the Phase Pattern.

**Template Parameters**

The two Template Parameters select from one of three banks of Drum Pattern Templates within the current selected Template Bank (shared by all three Drum Patterns), and load the parameters into the selected Drum Pattern Editing Grid and associated parameters. Each Drum Template Bank contains 63 or 64 different Drum Pattern Templates.

A Drum Pattern Template consists of:

- the configuration of the Drum Pattern Grid
- "poly/pools" setting
- the 7 choices in the Drum Sounds menus
- Random Weighting Parameters - Pools (if applicable)

- Random Weighting Parameters - Rest (if applicable)
- the setting of the "Always Column"

**Template Bank 1...3 [1...63]**

⌘p.1039 "Rhythm Group": "Template".

**Template Bank 1...3 + Restore [0: [As Stored],1...63]**

⌘p.1039 "Rhythm Group": "Template + Restore".

## Direct Index Group

### Overview

Direct Index means to take a controller and map it into the Note Series directly, so that notes can be directly indexed and generated in real-time. One use is to take an area of a keyboard and map it into the Note Series, so that when you play the keys you are not generating the true note, but are selecting notes from within the Note Series. You can set up one area of the keyboard to supply the input notes to the Note Series, and another area to perform the Direct Indexing. This can allow you to “solo” with musically correct notes, without really thinking about what you are doing. Another use is to take a controller like a Joystick and map it into the Note Series, so that sweeping the controller sweeps through the Note Series and generates glissandos and

flurries of notes. This can be done in addition to the normal effect that the GE may be programmed to generate.

Note that to perform Directing Indexing, a controller must be selected as a **Source** in 7-7: Dynamic MIDI page, and one of two different options selected as a “Destination”:

- Direct Index
- DI & MdlStop (Direct Index & Module Stop)

For more information, see “Dynamic MIDI Sources & Destinations” on page 1109.

### General Parameters

The parameters in this section affect the overall Direct Indexing effect in general.

#### Index Shift [0...3]

- |           |           |
|-----------|-----------|
| 0: Top    | 2: Center |
| 1: Bottom | 3: Skip   |

Selects one of several options for shifting the indexes coming from the controller, if the Note Series at any given time is longer than the range of the selected controller. For example, if you specified an octave of keys (12 keys) as a controller, and there were 24 notes in the Note Series, those 12 potential indexes can be directed to different areas of the Note Series.

If the number of steps in the range of the selected controller is less than or equal to the number of notes in the Note Series, this parameter has no effect and KARMA automatically maps the indexes to the proper notes. If the number of steps is equal, there will be a predictable one-to-one correspondence between the controller and the Direct Index notes. If there are fewer notes in the Note Series than, KARMA automatically maps the indexes in a way that prevents adjacent controller indexes from selecting the same note. In addition, in the case of using a CC to sweep through the Note Series, values that would cause duplicate notes will be filtered out. This means you can comfortably use a CC with a range of 0-127 to sweep through a 15 note Note Series.

#### 0: Top

If the length of the Note Series is greater than the range of the selected controller, the indexes will be shifted to the top, so that the highest Direct Index note will be the highest note in the Note Series.

#### 1: Bottom

If the length of the Note Series is greater than the range of the selected controller, the indexes will be shifted to the bottom, so that the lowest Direct Index note will be the lowest note in the Note Series.

#### 2: Center

If the length of the Note Series is greater than the range of the selected controller, the indexes will be centered around the middle note of the Note Series.

#### 3: Skip

If the length of the Note Series is greater than the range of the selected controller, the indexes will be scaled into the Note Series so that the lowest Direct Index note will be the lowest note in the Note Series, the highest Direct Index note will be the highest note in the Note Series, and the other indexes will be spread out over the Note Series, resulting in one or more notes in the Note Series being skipped (cannot be indexed from the controller).

#### Trill Mode [0...5]

- |                    |                    |
|--------------------|--------------------|
| 0: Off             | 3: 3 Note Or More  |
| 1: 1 Note Or More  | 4: 4 Notes Or More |
| 2: 2 Notes Or More | 5: 5 Notes Or More |

Selects one of several options for producing an automatic randomized trill/arpeggio. When holding down a certain number of Direct Index notes, an automatic randomized trill/arpeggio can be produced. The rate at which the notes are generated is automatically calculated based on the tempo. This can be used to simulate fast soloing riffs while performing Direct Indexing.

#### 0: Off/DynMIDI

No trill effect will be introduced, no matter how many Direct Indexing notes are held down simultaneously.

#### 1...5: 1 Note Or More...5 Notes Or More

Specifies the required number of notes that must be held down before the trill/arpeggio starts. When set to “1 Note Or More,” playing even a single note causes it to start repeating at the automatically calculated rate. Other notes may then be added to become part of the trill/arpeggio.

**Held Note Trig Mode****[0...3]**

0: Off  
1: Bend/Retrigger  
2: Retrigger  
3: Mute

Selects one of several options for deciding what happens when Direct Index notes are being sustained, and the chord is changed so that the sustained note(s) no longer “fit” with that chord (i.e. are no longer part of the Note Series). Part of the concept with this parameter is to allow soloing only within a “correct” key or Note Series.

**0: Off**

Nothing is done. The note(s) remain sustained, even if they are “wrong.”

**1: Bend/Retrigger**

If only one Direct Index note is being sustained, it is bent (with pitch bend) down to the nearest pitch in the new Note Series (if it is no longer present in the Note Series). If more than one note is being sustained, they will all be changed to the nearest notes in the new Note Series and retriggered. If several are sustained, and only one is “incorrect,” they will all be retriggered.

**2: Retrigger**

All sustaining Direct Index notes will be changed to the nearest notes in the new Note Series and retriggered. If several are sustained, and only one is “incorrect,” they will all be retriggered.

**3: Mute**

Any sustaining Direct Index notes not present in the new Note Series will be shut off.

**Transpose [-36...+36 (semitones)]**

Transposes the pitch of the Direct Indexing notes as they are selected from the Note Series. This separate setting allows you to choose the octave for Direct

Indexing independent of where the rest of the current GE is designed to work. Note that this is completely separate from the “Transpose” setting in the KARMA module parameters, so changing the octave there will have no effect on Direct Indexing.

**Vel. Sensitivity (Kbd) [1...127 – bottom of range]**

Specifies the lower limit of a scaled velocity range (‘n’ to 127). Triggers being provided by a velocity sensitive controller will be scaled according to this before being applied to the Note Series. This controls the velocities of the Direct Index notes as they are generated. For example, if the value is 1, then the velocities would be exactly as played with an unmodified range of 1–127 (full sensitivity). If the value is 64, the velocities would be half as sensitive, because any velocity received from 1–127 will be scaled into the range of 64–127. Note that if the controller is a CC such as a joystick, there is no velocity associated with moving it, so the last received keyboard velocity is used, or a default.

**Vel. Offset (CCs) [0...200%]**

When a CC such as a joystick or ribbon is being used as a Direct Index controller, there is no velocity associated with moving it, so the last received keyboard velocity is used, or a default. Velocity Offset (CCs) specifies an amount by which the velocity of the indexed notes will be offset from the GE’s internal velocity setting. This allows you to make them a bit softer or louder than generated notes from the same GE, for example. The value is a percentage of the initial velocity, so values **less than 100** will produce softer indexed notes, while values **greater than 100** will produce louder notes. A value of 0% will effectively stop the generation of indexed notes.

**Duration Parameters**

The parameters in this section affect the durations of the Direct Index notes. You can be in control of them yourself from the keyboard, or select several different options for automatically generating the durations.

**Duration Control****[0...2]**

Determines whether the durations of the Direct Index notes will be controlled by the other parameters in this section, or by the user (through the controller doing the Direct Indexing). The notes that may be generated normally by the GE are still independently controlled by the settings in the Duration Group.

0: GE  
1: Kbd-Poly  
2: Kbd-Mono

**0: GE**

Direct Index notes will have the duration specified by the other two parameters in this section, the “Duration Mode” and the “Duration ms” (if applicable). The actual duration of the controller keys are not taken into account. For example, you might set up an effect with a short duration which then uses Melodic Repeat to generate further notes; setting this to “GE” ensures that the user’s release of a key has no effect on the actual durations.

**1: Kbd-Poly**

Direct Index notes will have the actual duration of the controller keys - pressing a key starts a note and releasing it ends a note. The “Duration Mode” and “Duration ms” become unavailable. This allows the user to control the duration, especially useful for simulating soloing. The controller will act polyphonically - multiple notes can be played and held down simultaneously.

**2: Kbd-Mono**

Same as **1: Kbd - Poly** above, except the keys act monophonically - you cannot play more than one note at a time. Useful for certain types of simulations such as saxophone and synthesizer solos.

**Duration Mode****[0...3]**

0: Poly Extend  
1: Poly Extend/Damped  
2: Mono Extend  
3: Timed

Selects one of several modes of operation for controlling durations of the Direct Index notes, when the “Duration Control” parameter is set to **0: GE**.

**0: Poly Extend**

Each note will sustain until the next generation of the same note, or until that note is no longer a part of the Note Series (caused by playing a new chord, for example). For example, if the notes to a CMaj chord are sustaining and the chord is changed to a CMinor, only the Es will be shut off.

**1: Poly Extend/Damped**

The same as above, except all sustaining notes will be damped when the chord changes, not just notes that are no longer in the Note Series.

**2: Mono Extend**

Each note is sustained until the next note (of any pitch) is generated.

**3: Timed (1...5000 ms)**

Makes available the "Duration ms" parameter, where you specify in milliseconds the duration of the generated notes. All notes will therefore have the same length. Note that this is independent of the current tempo - if it is set to **50 ms**, it will always be **50 ms**, regardless of tempo.

 Not available if "Duration Control" is not set to **0: GE**.

**Duration ms [1...5000 (ms)]**

When the "Duration Mode" above is 3: Timed, specifies in milliseconds the duration of the generated notes. All notes will therefore have the same length. Note that this is independent of the current tempo - if it is set to **50ms**, it will always be **50ms**, regardless of tempo.

 Not available if "Duration Control" is not set to **0: GE**, or Mode is not set to **3: Timed**.

## Repeat Parameters

**Melodic Rpt On/Off [0, 1]**

0: Off      1: On

Allows Melodic Repeat to be independently controlled for Direct Indexing. When this is **1: On**, the Direct Index notes will have Melodic Repeat according to the

settings of the parameters in the Melodic Repeat Group. This allows you to have a GE set up where the normally generated effect has Melodic Repeat while Direct Indexing does not, and vice versa, or other variations.

## Bend Parameters

This section controls automatic pitch bending effects that may be applied to the Direct-Indexed notes. Most of the following parameters have the same functionality as those described in the Bend Group. However, the bend specified here will only happen for Direct Indexing notes. This means that a GE can have one type of Auto Bend effect for notes that are being generated, and a different Auto Bend effect for Direct Index notes. Alternatively, Direct Indexing notes can have bending while notes generated automatically by the same GE do not, etc.

There are several differences between Direct Index Auto Bend and Auto Bend for generated notes (set in the Bend Group):

- It is not possible for the length of the bend to be set to "Note Duration" since in most cases the duration is not known ahead of time. Therefore, this option is not available in the Bend Group "Length" parameter.
- The **Next and Prev Note** bending options are replaced with **Next and Prev Index** options. The difference is that when notes are being generated, it is possible to calculate ahead of time what will be the next note. With Direct Indexing, it is impossible to know what the next note is since you chose it yourself. Therefore, when set to **Next Index**, it will bend from the currently chosen index in the Note Series to the next adjacent index in the Note series. The same difference applies for **Prev Index**. These differences are explained further below.

**Bend On/Off [0, 1]**

0: Off      1: On

When set to **0: Off**, Direct Index notes will have no bending, but the GE can still generate Auto Bend according to the Bend Group settings when triggered normally. When set to **1: On**, Direct Index notes will have bending according to the parameters in this Group - the settings in the Bend Group do not affect them (other than Bend Range).

**Bend Amount [-12...18]**

0: Random	15: Next Index+2
-12...12: -12...+12 semitones	16: Prev Index
13: Next Index	17: Prev Index-1
14: Next Index+1	18: Prev Index-2

 p.1069 "Bend Group": "Amount".

**0: Random**

 p.1069 "Bend Group": "Amount".

-12...12: -12...+12 semitones

 p.1069 "Bend Group": "Amount".

**13: Next Index**

Bends each note to the next index in the Note Series (note that this may be an up or down bend depending on how the Note Series is constructed and sorted). For example, if the Note Series contains {C, E, G, B, C...}, then when the E is Direct Indexed it will bend to the G.



**14: Next Index+1**

Bends each note to the index in the Note Series that is 2 indexes forward (note that this may be an up or down bend depending on how the Note Series is constructed and sorted). For example, if the Note Series contains {C, E, G, B, C...}, then when the E is Direct Indexed it will bend to the B.

**15: Next Index+2**

Bends each note to the index in the Note Series that is 3 indexes forward (note that this may be an up or down bend depending on how the Note Series is constructed and sorted). For example, if the Note Series contains {C, E, G, B, C...}, then when the E is Direct Indexed it will bend to the second C.

**16: Prev Index**

Bends each note to the previous index in the Note Series (note that this may be an up or down bend depending on how the Note Series is constructed and sorted). For example, if the Note Series contains {C, E, G, B, C...}, then when the B is Direct Indexed it will bend to the G.

**17: Prev Index-1**

Bends each note to the index in the Note Series that is 2 indexes backward (note that this may be an up or down bend depending on how the Note Series is constructed and sorted). For example, if the Note Series contains {C, E, G, B, C...}, then when the B is Direct Indexed it will bend to the E.

**18: Prev Index-2**

Bends each note to the index in the Note Series that is 3 indexes backward (note that this may be an up or down bend depending on how the Note Series is constructed and sorted). For example, if the Note Series contains {C, E, G, B, C...}, then when the B is Direct Indexed it will bend to the first C.

**Bend Shape [0...2]**

0: Bend      1: Hammer      2: Hammer Bend

Ⓜp.1070 "Bend Group": "Shape"

**Bend Alternation [0, 1]**

0: Off      1: Alternating

Ⓜp.1070 "Bend Group": "Alternation"

**Bend Step [0, 1]**

0: Smooth      1...12: 1 ST...12 ST

Ⓜp.1070 "Bend Group": "Step Mode"

**Bend Length [0...25]**

0: 64th triplet	9: 8th triplet	18: Whole triplet
1: 64th	10: 8th	19: Whole
2: 64th dotted	11: 8th dotted	20: Whole dotted
3: 32th triplet	12: Quarter triplet	21: 2 bars
4: 32th	13: Quarter	22: 3 bars
5: 32th dotted	14: Quarter dotted	23: 4 bars
6: 16th triplet	15: Half triplet	24: Fixed (ms)
7: 16th	16: Half	25: Note Duration
8: 16th dotted	17: Half dotted	

Ⓜp.1070 "Bend Group": "Length"

**Bend Fixed-ms [10...5000 (ms)]**

Ⓜp.1071 "Bend Group": "Fixed-ms"

**Bend Start % [0...100 (%)]**

Ⓜp.1071 "Bend Group": "Start %"

**Bend End % [0...100 (%)]**

Ⓜp.1071 "Bend Group": "End %"

**Bend Width % [0...100 (%)]**

Ⓜp.1071 "Bend Group": "Width %"

## Appendices

### Using Auto-Bend

**Auto-Bend** refers to a feature of KARMA that can generate a bend along with every generated note. It can be used to create gliding effects between notes (simulating portamento), to automatically bend each note to a preset step size, to produce guitar “hammer-on” effects (where a fret is pressed with a finger to a new note after the note has already been picked, without restriking the note), ethnic bending, and other unique effects.

**Note:** There are several other ways of producing Pitch Bend data in KARMA, including using Pitch Bend Envelopes, and generating stepped Pitch Bend with the CCs/Pitch Group. This chapter does not apply to those additional methods.

#### Next Note/Previous Note Bends

##### Generated

When the “GE Type” (p.1023) is **0: Generated-Riff** or **1: Generated-Gated**, Next Note Bending allows the current note to bend to what will be the next note, the note two away, or the note three away. Previous Note Bending allows the current note to bend to what was the previous note, the note two notes previous, or the note three notes previous.

When beginning a riff with **Previous Note bends** selected, since the first notes have not actually been played yet, KARMA extrapolates what they would have been based on the settings of various parameters. Most of the time this will produce a correct bend.

When using **Next Note bend** with Random Modes, KARMA actually does know what the next Note(s) will be, even though they are “Random”.

If the note to be bent to is the same note as the current note (a bend of 0) KARMA automatically chooses a bend to another note nearby to maintain the illusion of continuous bending.

**Note:** The maximum bend size is controlled by the Bend Range setting (usually 12 semitones), even if the next/previous note is farther away.

Also, although KARMA knows what the next notes will be while it is playing a riff, it can’t know when you are going to change a chord and start a new riff. Therefore, the last notes before a chord change may not bend to the correct notes at the start of a new riff, since they will bend to what would be the next note if you hadn’t changed chords. Most of the time this is not a problem and still sounds musically correct.

When using Next/Prev Note Bending with Clusters, Clusters will appear to bend from their bottom note to whatever the next/previous note is.

##### Real-Time

When the “GE Type” (p.1023) is **3: Real-Time**, only **Previous Note bending** is available, since KARMA cannot know which note you will play next. However, by using the Bend Direction parameter, you can bend either “To” the previous note, or “From” the previous

note to the one you are playing now. The Bend Shape you are using probably determines which one makes more sense. For example, for Hammer-ons you will probably want to bend “To” the previous note (because the Hammer Shape bends it back afterwards); while for the Bend Shape, you will probably want to bend “From” the previous note to the one you have played now, since that is where the bend will end up to the ear. However, it’s up to you!

#### Length Of Bends

##### “GE Type” 0: Generated-Riff, 1: Generated-Gated or 2: Generated-Drum

###### Bend Group “Length” is 0...23: Note Values

The bend length is determined by the chosen note value and will be the same regardless of the actual duration or rhythm of the notes. For example, if the Bend Group “Length” is **7: 16th**, then the overall Bend will be within a 16th note, even if you are generating a pattern with quarter notes, eighth notes, and 16th notes mixed together. This allows each bend to be the same length, yet maintain a relationship to tempo, since slowing down the tempo will also lengthen the bend, for example. This also allows the durations of the notes to be varied in real-time without changing the position or length of the bends.

###### Bend Group “Length” is 24: Fixed-ms

The overall bend is determined by a fixed value in milliseconds, and will be the same length regardless of the tempo setting. For example, this allows an absolute bend length to be determined that does not change with the tempo, so that a guitar line with a bend in it will play slower at a slower tempo, but not bend any slower. This also allows the durations of the notes to be varied in real-time without changing the position or length of the bends.

###### Bend Group “Length” is 25: Note Duration

The length of the bend is a percentage of the note’s duration. Therefore, if you have the Duration Group parameters set to produce very short durations, then very short bends (almost inaudible) will be produced. However, with normal length durations, using this mode allows the bend to be scaled with each note - longer notes get longer bends, shorter notes get shorter bends, etc. Changing the durations of the notes in real-time changes the length and position of the bends.

Note that a bend will never be longer than the rhythm of the generated note itself, even if you are creating overlapping notes. In other words, the start of a new note stops the current bend, and potentially starts another one. The diagram in the next section illustrates the resulting bend when the shape is “Bend,” and shows the difference between using Note Duration and one of the other “Bend Length” settings.

### “GE Type” 3: Real-Time

Since the duration of the note is determined by actually playing the keyboard, Bend Group “Length” 25: **Note Duration** is not available for this GE Type, and will act the same as 7: **16th** if selected. The other Bend Length settings operate as described above.

### The Different Bend Shapes

#### Bend

When the “Bend” Shape is selected in the Shape Parameter, the Start Parameter specifies where in the note’s duration the bend will start, and the End Parameter specifies where in the note’s duration the bend will end. The following diagram illustrates the resulting bend when the shape is “Bend,” and also the difference between Note Duration and Fixed/Note Values settings.

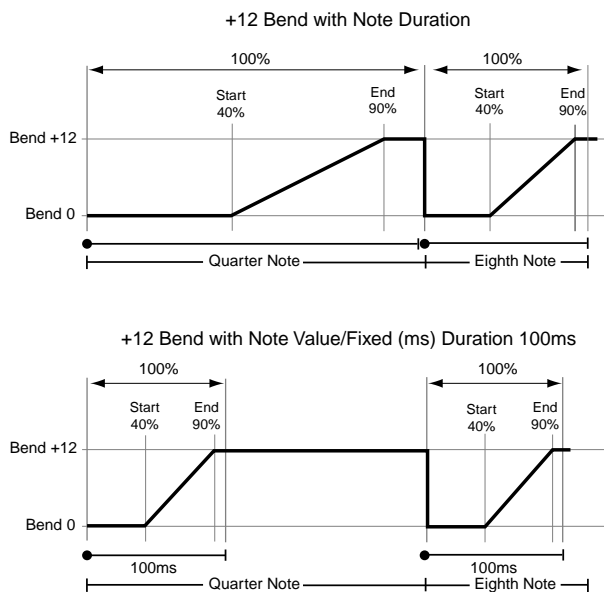

The following diagrams illustrate the shape of a Hammer Bend. A Hammer is the same thing, without the final 3rd bend at the end. Hammers and Hammer Bends follow the same behavior with Duration as discussed in the previous section Length Of Bends.

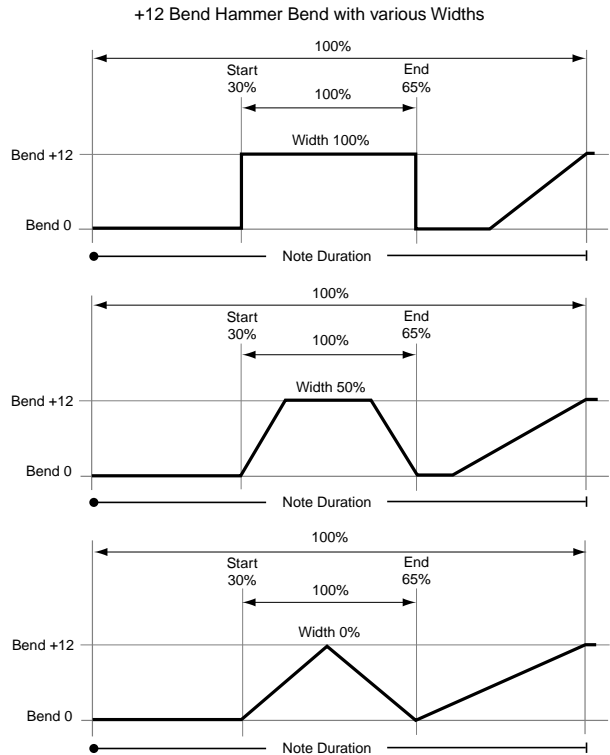

### Hammer, Hammer Bend

When the “Hammer” or “Hammer Bend” Shape is selected, the Start and End Parameters function a bit differently. Start specifies where in the note’s duration the 1st bend will start and go to the bend’s highest value (Hammer-On), and End specifies where in the note’s duration the 2nd bend will start and return to zero (Hammer-Off). Additionally, a 3rd bend is generated for Hammer Bends.

Also, when the “Hammer” or “Hammer Bend” Shape is selected, the Width Parameter is available. Width is a percentage of the amount of time between the Start and End points, and therefore controls how long the Hammer-On and Hammer-Off bends will be. You can also think of Width as being the amount of time the bend stays at it’s highest value before returning to zero. A Width of 100% gives you a Square Shape, while a Width of 0% gives you a Triangle Shape.

In a Hammer Bend, the 3rd bend starts at a point in the note’s duration following the End setting, and is determined by a ratio of the Width. Even when Width is at 100% and the Hammer-On and Hammer-Off Bends are instantaneous, the final 3rd bend will still be an audible bend.

## Random Weighting Curves

### Weighting Curve Shapes and Their Effects

When using the various grid-based Patterns, more than one value selected in a column creates a “pool” of random choices. Different areas of the pool may be selectively favored using a Weighting Curve. 4

different shapes are available, which act to favor certain areas of the pool over others when each random choice is made. The actual shape of the curve depends on the setting of the “Factor” parameter.

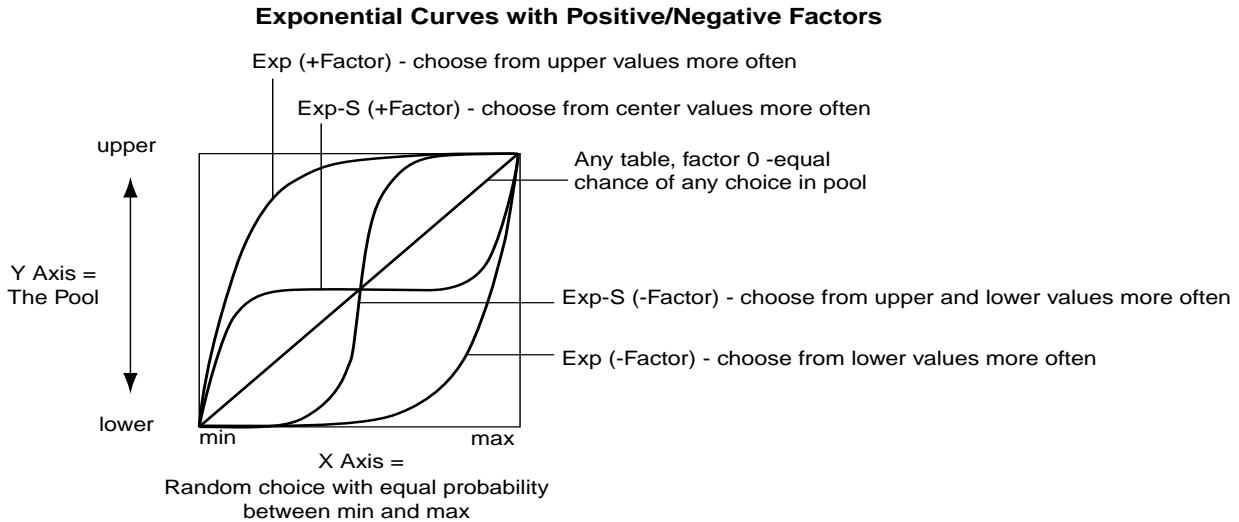

#### Exponential (Exp)

With a **positive Factor (+)**, choices will be exponentially weighted towards the upper values in the pool. With a **negative Factor (-)**, choices will be exponentially weighted towards the lower values in the pool.

#### Logarithmic (Log)

With a **positive Factor (+)**, choices will be logarithmically weighted towards the upper values in the pool. With a **negative Factor (-)**, choices will be logarithmically weighted towards the lower values in the pool.

#### Exponential S (Exp-S)

With a **positive Factor (+)**, choices will be exponentially weighted towards the center values in the pool, and away from the lower and upper values in the pool. With a **negative Factor (-)**, choices will be exponentially weighted towards the lower and upper values in the pool, and away from the values in the center of the pool.

#### Logarithmic S (Log-S)

With a **positive Factor (+)**, choices will be logarithmically weighted towards the center values in the pool, and away from the lower and upper values in the pool. With a **negative Factor (-)**, choices will be logarithmically weighted towards the lower and upper values in the pool, and away from the values in the center of the pool.

Using negative Factors not only inverts but rotates the curve.

The following table summarizes the effect of the Factor field on the curves and the pools:

Weighting Curve	Factor	
	+ (positive)	- (negative)
Exp/Log	upper	lower
Exp-S/Log-S	center	lower/upper

### Comparison of Exponential and Logarithmic Curves

Exponential Curves and Logarithmic Curves have similar shapes. They are different, however, as the following diagram illustrates:

Pool values that receive priority:

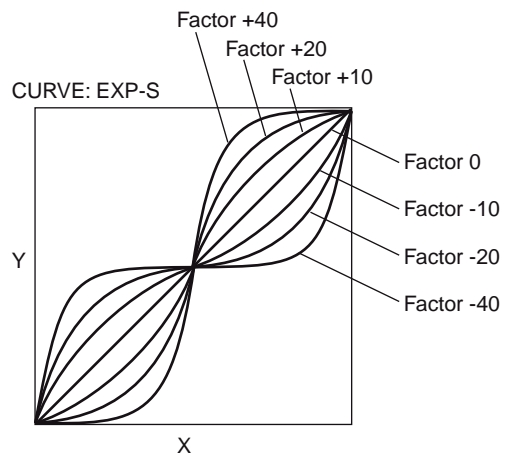
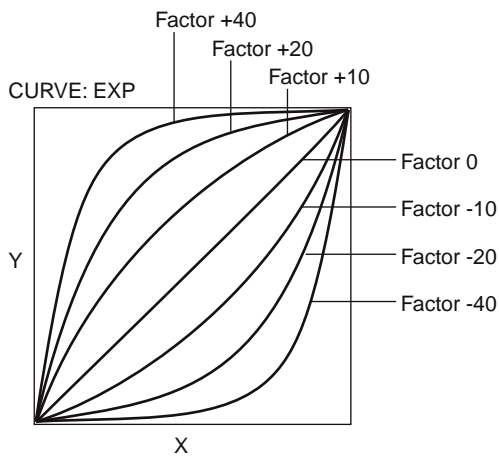
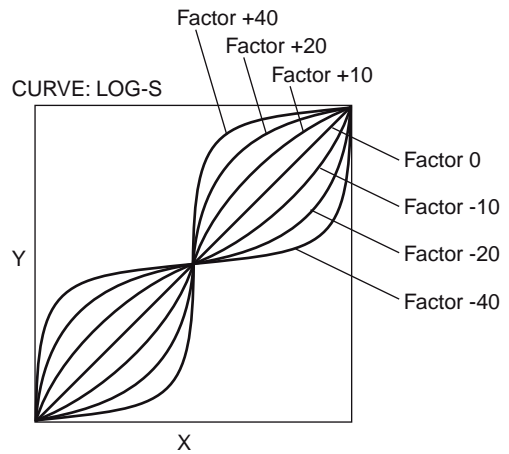
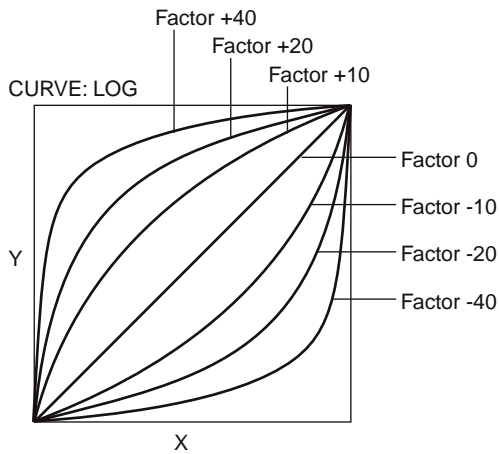

X Axis = random choice with equal probability between min and max. Y Axis = the Pool.

This characteristic can be used to even more finely tune the effect you are trying to achieve. For example, the top and bottom curves in both the Log and Exp diagrams (Factor 40 and -40) above are shown together below:

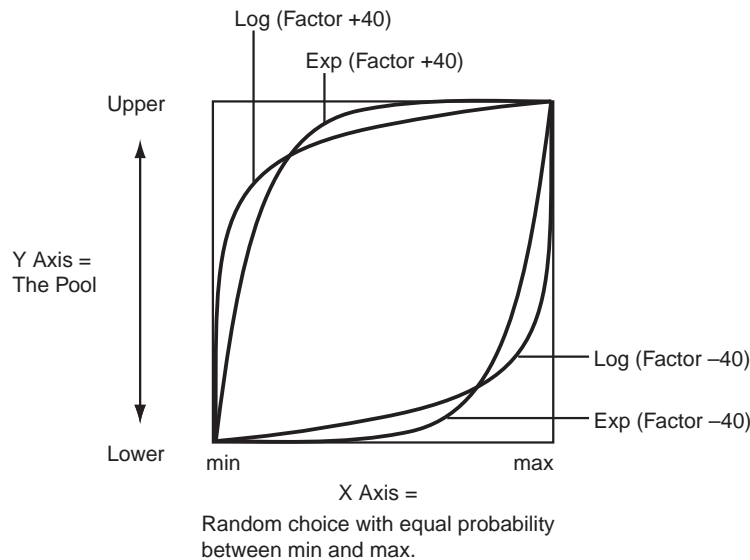

**With a Positive Factor (+40):**

**Exponential Curve (Exp)**

75% chance of a choice from the upper 10% of the pool;  
 25% chance of a choice from the lower 90% of the pool.

**Logarithmic Curve (Log)**

90% chance of a choice from the upper 25% of the pool;  
 10% chance of a choice from the lower 75% of the pool.

In general, as the positive factor increases, the Exp Curve will produce choices more from the very highest part of the pool, with a choice from the remaining portion more likely to occur than with the Log Curve. In contrast, the Log Curve will produce choices more from the mid high to highest part of the pool, with a choice from the remaining portion less likely to occur than with the Exp Curve.

Therefore, while both curves will weight the random choices toward the upper values in the pool, the Log Curve provides less of a chance of the lower and center values ever occurring, while allowing a more even distribution among the upper values. The Exp Curve provides more certainty that the highest values will be chosen, while still allowing a more even distribution among the center and lower values than the Log Curve.

**With a Negative Factor (-40):**

**Exponential Curve (Exp)**

75% chance of a choice from the lower 10% of the pool;  
 25% chance of a choice from the upper 90% of the pool.

**Logarithmic Curve (Log)**

90% chance of a choice from the lower 25% of the pool;  
 10% chance of a choice from the upper 75% of the pool.

In general, as the negative factor decreases, the Exp Curve will produce choices more from the very lowest part of the pool, with a choice from the remaining portion more likely to occur than with the Log Curve. In contrast, the Log Curve will produce choices more from the mid low to lowest part of the pool, with a choice from the remaining portion less likely to occur than with the Exp Curve.

Therefore, while both curves will weight the random choices toward the lowest values in the pool, the Log Curve provides less of a chance of the higher and center values ever occurring, while allowing a more even distribution among the lower values. The Exp Curve provides more certainty that the lowest values will be chosen, while still allowing a more even distribution among the center and upper values than the Log Curve.

**⚠** A Factor of 0 with any shaped curve yields a linear table (straight diagonal line), and each of the values in the pool will have an equal chance of getting chosen.

# Appendices

## Alternate Modulation Sources (AMS)

### Alternate Modulation Overview

Alternate Modulation lets you use controllers, envelopes, LFOs, etc. to modulate Program parameters. They're called "Alternate Modulation" because they are in addition to the many dedicated modulation routings, such as Filter EG to Filter Cutoff, or LFO to Pitch.

You can use one controller to modulate multiple parameters simultaneously. You can also create complex modulation setups in which (for example) an envelope modulates the frequency of an LFO, and that LFO is then used to modulate a filter.

As shown in the diagrams below, the parameters you can control via alternate modulation will depend on the synth engine (HD-1, AL-1, CX-3 etc.). For each of these destination parameters, you can select an AMS (Alternate Modulation Source) to modulate it.

HD-1 Programs provide 48 types (88 destinations) for alternate modulation.

The EXi Common section provides 7 alternate modulation destinations, the AL-1 provides 92, and the CX-3 provides 20, and the STR-1 provides 131 (not counting the AMS mixers). For information on other EXi, please see their individual documentation.

### AMS Mixers

The AMS Mixers combine two AMS sources into one, or process an AMS source to make it into something new.

For instance, they can add two AMS sources together, or use one AMS source to scale the amount of another. You can also use them to change the shapes of LFOs and EGs in various ways, modify the response of realtime controllers, and more.

The AMS Mixer outputs appear in the list of AMS sources, just like the LFOs and EGs.

The original, unmodified inputs to the AMS Mixers are still available as well. For instance, if you use LFO 1 as an input to a AMS Mixer, you can use the processed version of the LFO to control one AMS destination, and the original version to control another.

Finally, you can cascade two or more AMS Mixers together, by one as an input to another.

For more information, see "6-1: OSC 1 AMS Mixer" on page 98, and "Using the AMS Mixers" on page 47 of the Operation Guide.

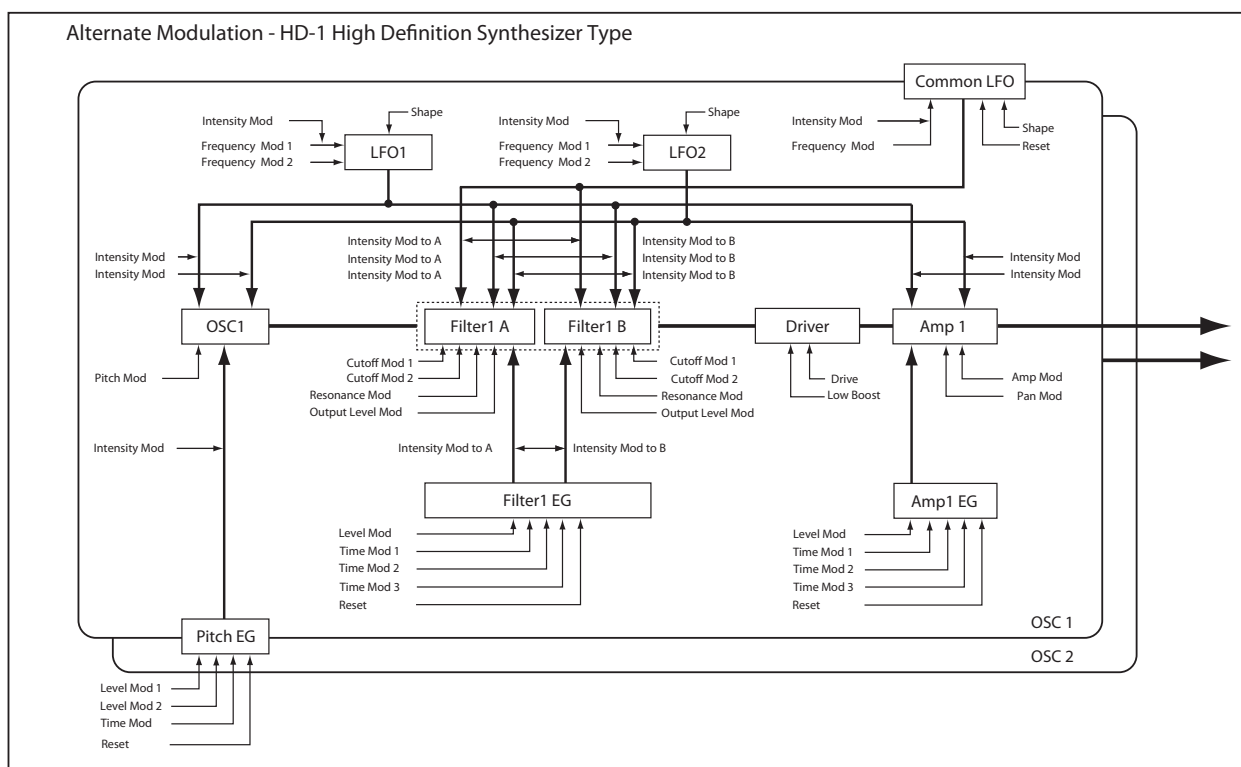



Alternate Modulation - EXi AL-1 Analog Synthesizer Type

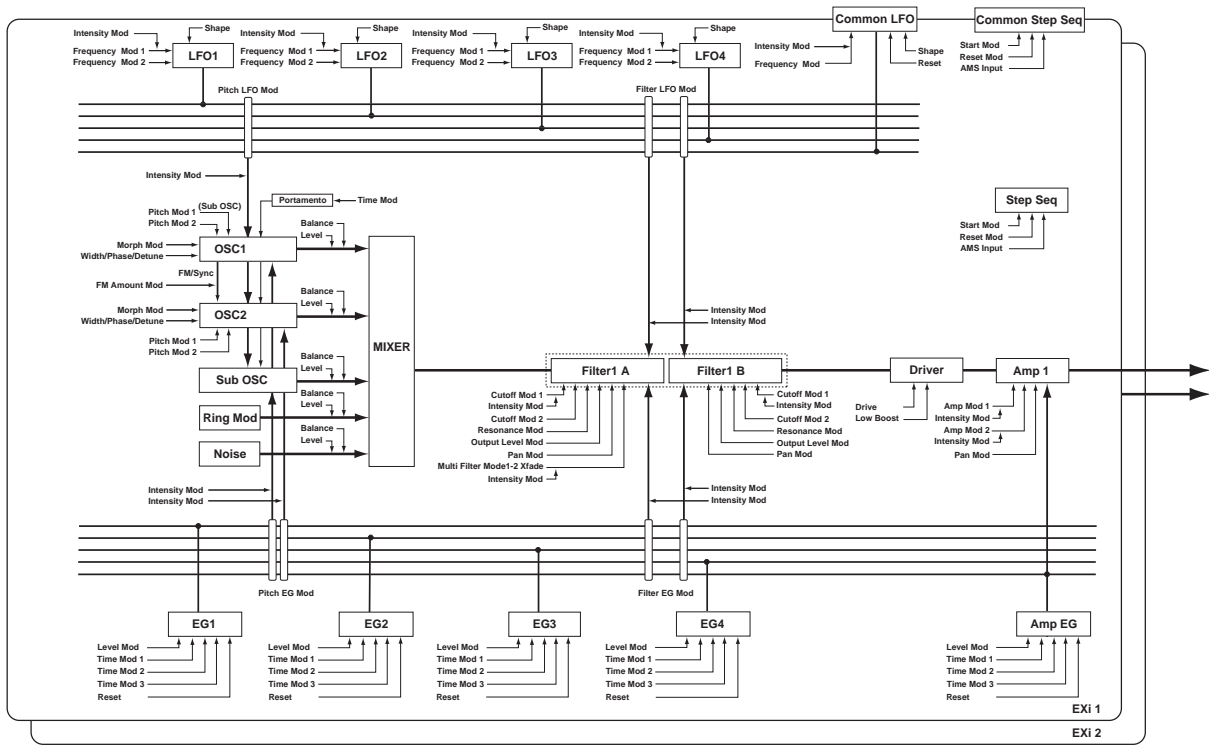

Alternate Modulation - EXi CX-3 Tonewheel Organ Type

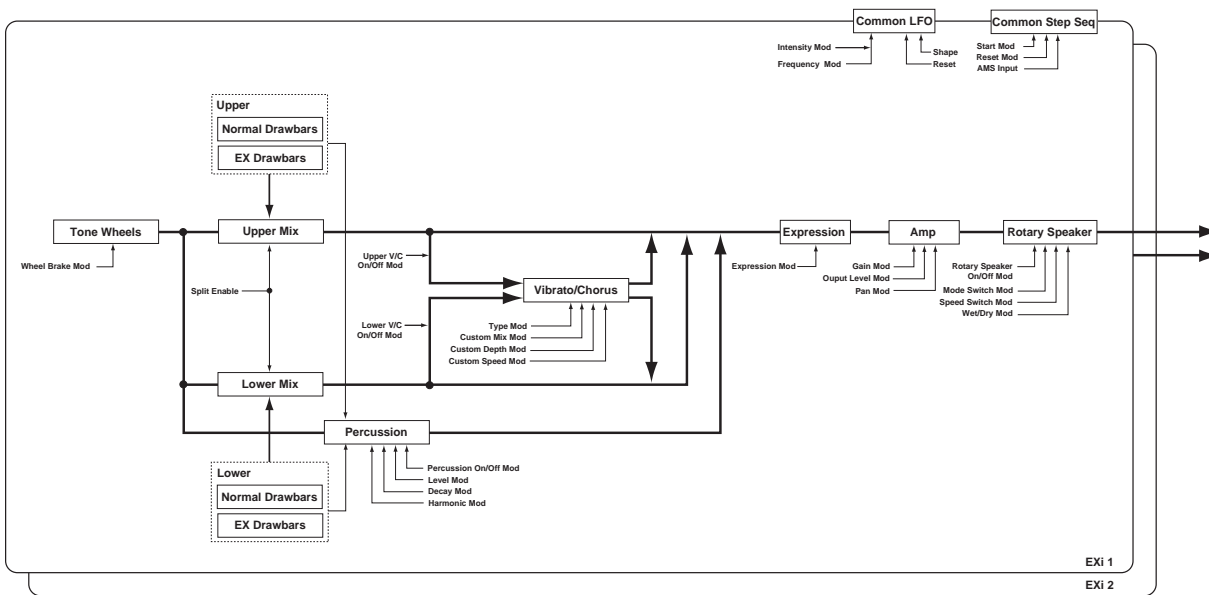

## Alternate Modulation Source (AMS) List

### Physical and MIDI controllers

#### Off

This means that no modulation source is selected.

#### Note Number

This is the note's MIDI note number, from 0 (C-2) to 127 (G9).

#### Velocity

This is the note's MIDI note-on velocity.

#### Exponential Velocity

This is MIDI note-on velocity through an exponential curve. The curve means that low velocities won't have very much effect, and the difference between two lower velocity values won't be very noticeable.

On the other hand, high velocities produce increasingly greater effects, and the difference between any two higher velocity values will be more pronounced.

#### Poly After Touch

Polyphonic aftertouch allows a different aftertouch value for each note. This can be received from external MIDI devices or generated by the internal sequencer. The KRONOS keyboard itself does not generate poly aftertouch, however.

#### After Touch

This receives MIDI Aftertouch, as well as aftertouch generated by pressing down on the KRONOS keyboard.

#### JS X

This is the horizontal movement of the main joystick. It also receives MIDI Pitchbend.

#### JS+Y (CC#01)

This is the vertical movement of the main joystick, upwards from the center. It also receives MIDI CC#01 (mod wheel).

#### JS-Y (CC#02)

This is the vertical movement of the main joystick, downwards from the center. It also receives MIDI CC#02 (breath controller).

#### JS +Y & AT/2 (Joy Stick +Y & After Touch/2)

The effect will be controlled by the joystick +Y (Vertical upward) and by after touch. In this case, the effect of after touch will be only half of the specified intensity.

#### JS -Y & AT/2 (Joy Stick -Y & After Touch/2)

The effect will be controlled by the joystick -Y (Vertical downward) and by after touch. In this case, the effect of after touch will be only half of the specified intensity.

#### Foot Pedal (CC#04)

This AMS source receives MIDI CC#04. It can also be generated by a foot pedal connected to the rear-panel ASSIGNABLE PEDAL input, if the Global **Foot Pedal Assign** parameter is set to Foot Pedal (CC#04). For more information, see "Foot Pedal Assignments" on page 1108.

#### Ribbon (CC#16)

This is the side-to-side movement of the ribbon controller, which corresponds to MIDI CC#16.

#### Value Slider (CC#18)

You can use the value slider as a modulation source, but only when the following are true:

- You're on the Program mode P0-Main page, and the big Program name is selected, or
- You're on the Combination mode P0- Prog Select/Mixer page, and the big Combination name is selected.

In these cases only, the value slider sends MIDI CC#18, and can be used as a modulation source.

#### Knob Mod.5 (CC#17)

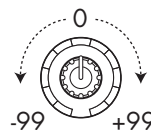

This AMS source always responds to MIDI CC#17. A MIDI value of 0 (far left) causes the maximum negative modulation; 64 (center) means no modulation; and 127 (far right) causes the maximum positive modulation. (You can invert this response, if desired, by using a negative AMS intensity.)

It also usually corresponds to Knob 5 (USER 1) on the Control surface- but this depends on the Modulation Knob Assign settings for each individual Program, Combi, and Song.

Basically, there are two separate things: a physical knob named Knob 5, and an AMS source named "Knob Mod.5 (CC#17)." This provides a great deal of flexibility—but's it's also easy to link the two together. To do so:

1. Go to the current mode's **Controllers** page.
2. Set **Knob 5's Modulation Knob Assign** to **Knob Mod.5 (CC#17)**.

For more information, see "1-8: Set Up Controllers" on page 53, and "Realtime Knobs 5-8 Assignments" on page 1105.

#### Knob Mod.6 (CC#19)

This AMS source always responds to MIDI CC#19, and will usually also correspond to Knob 6 (USER 2). For more information, see "Knob Mod.5 (CC#17)" on page 1091.

**Knob Mod.7 (CC#20)**

This AMS source always responds to MIDI CC#20, and will usually also correspond to Knob 7 (USER 3). For more information, see “Knob Mod.5 (CC#17)” on page 1091.

**Knob Mod.8 (CC#21)**

This AMS source always responds to MIDI CC#21, and will usually also correspond to Knob 8 (USER 4). For more information, see “Knob Mod.5 (CC#17)” on page 1091.

**Knob Mod5 [+](CC#17)**

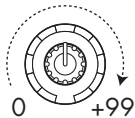

This is similar to “Knob Mod.5 (CC#17)” on page 1091, except that the range goes from 0 at the far left to +99 at the far right, corresponding to MIDI CC values of 0 and 127 respectively.

For more information, see “Knob Mod.5 (CC#17)” on page 1091.

**Knob Mod6 [+](CC#19)**

This is similar to “Knob Mod.6 (CC#19)” on page 1091, except that the range goes from 0 at the far left to +99 at the far right, corresponding to MIDI CC values of 0 and 127 respectively.

For more information, see “Knob Mod.5 (CC#17)” on page 1091.

**Knob Mod7 [+](CC#20)**

This is similar to “Knob Mod.7 (CC#20)” on page 1092, except that the range goes from 0 at the far left to +99 at the far right, corresponding to MIDI CC values of 0 and 127 respectively.

For more information, see “Knob Mod.5 (CC#17)” on page 1091.

**Knob Mod8 [+](CC#21)**

This is similar to “Knob Mod.8 (CC#21)” on page 1092, except that the range goes from 0 at the far left to +99 at the far right, corresponding to MIDI CC values of 0 and 127 respectively.

For more information, see “Knob Mod.5 (CC#17)” on page 1091.

**Damper (CC#64)**

This is the Damper pedal, also sometimes called the sustain pedal. It corresponds to MIDI CC#64.

When using Korg’s optional half-damper pedal, the DS-1H, this AMS source is continuous—not just on/off.

**Porta. SW (CC#65)**

This is the MIDI portamento switch (CC#65), which also enables and disables portamento.

**Sostenuto (CC#66)**

This is the MIDI sostenuto pedal (CC#66).

**Soft (CC#67)**

This is the MIDI soft pedal (CC#67).

**SW1 Mod. (CC#80)**

This is CC#80, which is the default for assignable front-panel switch 1 (SW1). To use SW1 and SW2 as AMS sources:

1. Go to the Set Up Controllers page.
2. Under Panel Switch Assign, assign SW1 to SW1 Mod. (CC#80) and SW2 to SW2 Mod. (CC#81).

These assignments are stored separately for each Program, Combination, and Song.

For more information, see “SW1/2 Assignments” on page 1104.

**SW2 Mod. (CC#81)**

This is CC#81, which is the default for assignable front-panel switch 2 (SW2). For more information, see “SW1 Mod. (CC#80),” above.

**Foot Switch (CC#82)**

This AMS source receives MIDI CC#82. It can also be generated by a foot switch connected to the rear-panel ASSIGNABLE SWITCH input, if the Global Foot Pedal Assign parameter is set to Foot Switch (CC#82). For more information, see “Foot Switch Assignments” on page 1106.

**Controller (CC#83)**

MIDI control change (CC#83)

**VJS +X Mod.(CC#85)**

This is MIDI CC#85, which is the default assignment for horizontal movement of the vector joystick, to the right of the center point.

To use the vector joystick as an AMS source, go to the Vector Control page or Vector CC page for each program, combination, or song, and set the “Vector CC Control” parameters as below:

- +X: VJS +X Mod. (CC#85)
- X: VJS -X Mod. (CC#86)
- +Y: VJS +Y Mod. (CC#87)
- Y: VJS -Y Mod. (CC#88)

Note: If “VJS X/Y Mode” is Positive or Negative, you’ll be able to use either + or -, not both.

**VJS -X Mod.(CC#86)**

This is the horizontal movement of the vector joystick, to the left of the center point. It corresponds to MIDI CC#86.

For more information, see “VJS +X Mod.(CC#85),” above.

**VJS +Y Mod.(CC#87)**

This is the vertical movement of the vector joystick, upwards from the center point. It corresponds to MIDI CC#87.

For more information, see “VJS +X Mod.(CC#85),” above.

**VJS -Y Mod.(CC#88)**

This is the vertical movement of the vector joystick, downwards from the center point. It corresponds to MIDI CC#87.

For more information, see “VJS +X Mod.(CC#85),” above.

**Tempo**

This lets you use the system tempo as a modulation source. 120 is the center, for a value of 0; 60BPM is -99, and 240BPM is +99.

Note that this is different from actually syncing to tempo; for that purpose, use the dedicated synchronization functions for the LFOs, effects, etc.

**Gate1 and Gate1+Damper**

Gate 1 is triggered by a new note after all notes have been released, such as at the beginning of a phrase. Gate 1+Damper is similar, except that it is triggered by a new note-on after all notes and the damper are released.

You can use this to reset the Common LFO and Common Step Sequencer. For instance, to create an effect similar to the per-voice LFO and Step Sequencer’s **Key Sync Off** setting, use **Gate 1 + Damper** as the reset source.

**Gate2 and Gate2+Damper**

Gate 2 is similar to Gate 1, but it triggers with every new note-on, even in the middle of a legato phrase. Gate2+Damper includes the damper pedal in the equation, as shown in the diagram below.

*Note:* When used as a reset controller for Common LFO and Common Step Sequencer, Gate2 and Gate2+Damper will have the same effect.

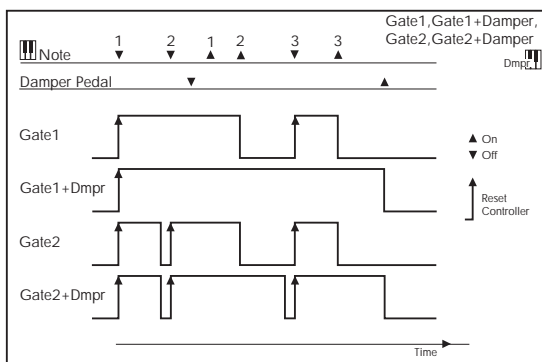

**HD-1**

The HD-1 supports all of the “Physical and MIDI controllers,” as described on page 1091, in addition to the AMS sources below.

**AMS Mixer1&2**

These are the outputs of the oscillator’s AMS Mixers. For more information, see “6-1: OSC 1 AMS Mixer” on page 98.

**Wave Seq AMS Out1&2**

These are the modulation outputs of the oscillator’s Wave Sequence. For more information, see “Modulating Program parameters per step” on page 170 of the Operation Guide.

**Pitch EG**

This is the output of the Pitch EG, which is shared between both oscillators. For more information, see “2-9: Pitch EG” on page 65.

**Filter EG**

This is the output of the oscillator’s Filter EG. For more information, see “3-4: Filter1 EG” on page 77.

**Amp EG**

This is the output of the oscillator’s Amp EG. For more information, see “4-3: Amp1 EG” on page 87.

**LFO1 &2**

These are the outputs of the oscillator’s two LFOs. For more information, see “5-1: OSC1 LFO1” on page 92.

**Common LFO**

This is the output of the Common LFO, which is shared by all voices of both oscillators. For more information, see “5-9: Common LFO” on page 96.

**Filter Key Track**

This is the output of the oscillator’s Filter Key Track generator. For more information, see “3-2: Filter1 Modulation” on page 72.

**Amp Key Track**

This is the output of the oscillator’s Amp Key Track generator. For more information, see “4-2: Amp1 Modulation” on page 84.

**Common Key Track1&2**

These are the outputs of the two Common Key Track generators, which are shared between both oscillators. For more information, see “6-9: Common Keyboard Track” on page 105.

**EXi Common**

EXi programs support all of the “Physical and MIDI controllers,” as described on page 1091, in addition to the AMS sources below, plus any AMS sources provided by the specific EXi instruments.

**Common Step Seq**

This is the output of the Common Step Sequencer, which is shared by all voices of both EXi. For more information, see “5-1: Common Step Seq” on page 177.

**Common LFO**

This is the output of the Common LFO, which is shared by all voices of both EXi. For more information, see “5-2: Common LFO” on page 180.

**Common Key Track1&2**

These are the outputs of the two Common Key Track generators, which are shared between both EXi. For more information, see “5-2: Common LFO” on page 180.

---

### EXi AL-1

The AL-1 supports all of the “EXi Common” AMS sources, in addition to the AMS sources below.

#### AMS Mixer1&2

These are the outputs of the two AMS Mixers. For more information, see “6-1: OSC 1 AMS Mixer” on page 98.

#### Step Sequencer

This is the output of the per-voice Step Sequencer. For more information, see “8-1: Step Sequencer” on page 215.

#### EG1 (Filter), EG2 (Pitch), and EGs 3 & 4

These are the outputs of the four assignable EGs. For more information, see “7-1: EG 1 (Filter)” on page 211.

#### Amp EG

This is the output of the dedicated Amp EG. For more information, see “6-3: Amp EG” on page 208.

#### LFO1 ...4

These are the outputs of the four assignable LFOs. For more information, see “8-2: LFO 1” on page 217.

#### Filter Key Track and Amp Key Track

These are the outputs of the Filter and Amp Key Track generators, respectively. For more information, see “5-3: Filter Modulation” on page 279 and “6-2: Amp Modulation” on page 284.

---

### EXi CX-3

The CX-3 supports all of the “EXi Common” AMS sources, in addition to the AMS sources below.

#### AMS Mixer1&2

These are the outputs of the two AMS Mixers. For more information, see “6-1: OSC 1 AMS Mixer” on page 98.

---

### EXi STR-1

The STR-1 supports all of the “EXi Common” AMS sources, in addition to the AMS sources below.

#### AMS Mixer1...4

These are the outputs of the four AMS Mixers. For more information, see “6-1: OSC 1 AMS Mixer” on page 98.

#### EG1 (Filter), EG2 (Pitch), and EGs 3 & 4

These are the outputs of the four assignable EGs. For more information, see “7-1: EG 1 (Filter)” on page 211.

#### Amp EG

This is the output of the dedicated Amp EG. For more information, see “6-3: Amp EG” on page 208.

#### LFO1 ...4

These are the outputs of the four assignable LFOs. For more information, see “8-2: LFO 1” on page 217.

### Filter Key Track and Amp Key Track

These are the outputs of the Filter and Amp Key Track generators, respectively. For more information, see “5-3: Filter Modulation” on page 200 and “6-2: Amp Modulation” on page 206.

### Damping String Track and Disp. String Track

These are the String Track generators for Damping and Dispersion, which can be used as AMS sources elsewhere in the STR-1. For more information, see “String Track” on page 265.

### String Track1 & 2

These are the assignable String Track generators 1 and 2. For more information, see “9-9: String Track” on page 290.

### Fret Position

The Fret Position is mostly used to shift the relationship between incoming notes and the String Track generators, but is also available as an AMS source. For more information, see “9-9a: Fret Position” on page 291)

### Fret Number

This AMS source models the current position on the neck. For more information, see “Fret Number AMS Source” on page 291.

---

### EXi MS-20EX

The MS-20EX supports all of the “EXi Common” AMS sources, in addition to the AMS sources below.

#### AMS Mixer1...4

These are the outputs of the four AMS Mixers. For more information, see “6-1: OSC 1 AMS Mixer” on page 98.

#### EG3...6

These are the outputs of the four assignable EGs. For more information, see “7-1: EG 1 (Filter)” on page 211.

#### MG Tri and MG Pulse

The MS-20EX MG always generates both the triangle/sawtooth and pulse/square waveforms, simultaneously. For more information, see “5-1b: MODULATION GENERATOR (MG)” on page 303.

#### LFO1 ...4

These are the outputs of the four assignable LFOs. For more information, see “8-2: LFO 1” on page 217.

---

### EXi PolysixEX

The PolysixEX supports all of the “EXi Common” AMS sources, in addition to the AMS sources below.

#### AMS Mixer1...4

These are the outputs of the four AMS Mixers. For more information, see “6-1: OSC 1 AMS Mixer” on page 98.

### Polysix EG

This is the output of the original Polysix ADSR envelope. For more information, see “4-1d: EG” on page 329.

### EG2...3

These are the outputs of the two assignable EGs (in addition to the original Polysix EG). For more information, see “7-1: EG 1 (Filter)” on page 211.

### MG and MG + Delay

These are the delayed and un-delayed outputs of the original Polysix MG. For more information, see “4-1b: MG (Modulation Generator)” on page 328.

### LFO1 ...2

These are the outputs of the two assignable LFOs. For more information, see “8-2: LFO 1” on page 217.

### EXi MOD-7

The MOD-7 supports all of the “EXi Common” AMS sources, in addition to the AMS sources below.

### AMS Mixer1...8

These are the outputs of the eight AMS Mixers. For more information, see “Program P9: Step Sequencer, LFO 1-4, and AMS Mixers” on page 384.

### EG1...9

These are the outputs of the nine assignable EGs. For more information, see “8-1: EG 1” on page 380.

### Amp EG

This is the output of the dedicated Amp EG. For more information, see “7-5: Amp EG” on page 379.

### LFO1 ...4

These are the outputs of the four assignable LFOs. For more information, see “8-2: LFO 1” on page 217.

### Filter Key Track and Amp Key Track

These are the outputs of the Filter and Amp Key Track generators, respectively. For more information, see “5-3: Filter Modulation” on page 200 and “6-2: Amp Modulation” on page 206.

### Step Sequencer

This is the output of the per-voice Step Sequencer. For more information, see “8-1: Step Sequencer” on page 215.

---

## Alternate Modulation settings

When you operate an AMS (Alternate Modulation Source), the modulation destination will be affected as shown in the table below.

By using alternate modulation, you can create complex systems of modulation in which EG, LFO, keyboard tracks, and controllers work together.

- You can apply complex change to an LFO or EG, for example by using the pitch/filter/amp EG to control the frequency or intensity of an LFO that modulates the pitch/filter/amp, or by using LFO2 to control the frequency of LFO1.
- The tone, EG, and LFO etc. can be controlled not only by velocity or joystick, but also from a switch, knob, or pedal etc.
- Panning can be controlled in realtime from a controller, EG, or LFO etc.
- You can use the filter EG to control pitch or volume at the same time that it controls the filter.
- Controllers etc. can be used to control EG levels or times. This lets you shape the EG in realtime.
- Filter/amp keyboard tracking or note number can be used to control the EG or LFO according to the keyboard pitch that is played.
- Pitch, tone, EG or LFO can be controlled by the tempo of the KARMA or sequencer.

HD-1 AMS

AMS source & value range										EXT(+/-) *1 -Max... 0...+Max EXT (Tempo) *2 =...60...120 ...240...	EXT(+) *3 0...127
Parameter	AMS Int.	Amp EG 0...+99	Pitch & Filter EGs -99... 0...+99	LFO1 & 2 -99... 0...+99	Common LFO -99... 0...+99	Filter & Amp Key Track -99... 0...+99	Common Key Track 1 & 2 -99... 0...+99	Wave Seq AMS Out 1 & 2 -99... 0...+99	Note Number C-2... C4...C9		
Pitch *4	+12.00	0...+1 Octave	-1...0...+1 Octaves (Filter EG as AMS; dedicated parameter for Pitch EG)	dedicated parameter	-1...0...+1 Octaves				dedicated parameter	-1...0...+1 Octaves	0...+1 Octave
Pitch EG Int.	+12.00	-	-	-	-1...0...+1 Octaves			-	-1...0...+1 Octaves		0...+1 Octave
Pitch LFO1/2 Int.	+12.00	0...+1 Octave	-1...0...+1 Octaves	-	-1...0...+1 Octaves						0...+1 Octave
Filter Frequency	+99	0...+10 Octaves	-10... 0...+10 Octaves (Pitch EG as AMS; dedicated parameter for Filter EG)	dedicated parameters					-10...0...+10 Octaves		0...+10 Octaves
Filter Resonance	+99	0...+99	-99...0...+99								0...+99
Filter EG Int.	+99	-	-	-	-99... 0...+99	-	-99... 0...+99	-	-	-99...0...+99	0...+99
Filter LFO1/2 Int.	+99	0...+99	-99... 0...+99	-	-99...0...+99						0...+99
Filter Output Level A/B	+99	0...+99	-99...0...+99								0...+99
Drive		0...+99	-99...0...+99								0...+99
Low Boost		0...+99	-99...0...+99								0...+99
Amp	+99	-	0...1x...8x	dedicated parameter	0...1x...8x	dedicated parameter	-	0...1x...8x	-	0...1x...8x	0...1x... 8x
Amp LFO1/2 Int.	+99	0...+99	-99... 0...+99	-	-99...0...+99						0...+99
Pan	+50	0...+63	-63...0...+63								0...+63
EG Level	+66	-	-	-	-99...0...+99			-	-99...0...+99		0...+99
EG Time	+49	-	-	-	1/64x...1x...64x			-	1/64x...1x...64x		1x...64x
LFO 1 Frequency *5	+99	1x... 64x	1/64x...1x... 64x	1/64x...1x... 64x (LFO2 only)					1/64x...1x...64x		1x...64x
LFO 2 Frequency *5	+99	1x... 64x	1/64x...1x... 64x	-					1/64x...1x...64x		1x...64x
Common LFO Frequency *5	+99	-	-	-	-		1/64x...1x... 64x	-	1/64x...1x...64x		1x...64x
Wave Sequence Start Step	+63	-	-	-	-63... 0...+63	-	-	-	-63...0...+63		0...+63



Wave Sequence Position	+63	0...+63	-63...0...+63	-	-	-	-	-63...0...+63	0...+63
Wave Sequence Step Duration	400%	1x...4x	1/100x...1x...4x	-	-	-	1/100x...1x...4x	-	1x...4x

Notes for the table

**\*1** EXT(+/-): JS X, Ribbon (CC#16), KnobMod.5 (CC#17), KnobMod.6 (CC#19), KnobMod.7 (CC#20), KnobMod.8 (CC#21)

**\*2** When Tempo is selected as an AMS source, the base value is ♩=120.

For example if the Pitch AMS is set to Tempo, and Intensity is set to 12.00, doubling the tempo value (♩=120 → 240) will raise the pitch one octave, and halving the tempo (♩=120 → 60) will lower the pitch one octave. The stated modulation results are for tempo values between 60bpm and 240bpm. As the tempo decreases from 60 to 0bpm, AMS modulation will have increasingly negative effects; as it increases from 240 to 250bpm, modulation will have increasingly positive effects.

**\*3** EXT(+): Velocity, Exponential Velocity, Poly After Touch, After Touch, JS+Y (CC#01), JS-Y (CC#02), JS+Y & AT/2, JS-Y & AT/2, Foot Pedal (CC#04), Value Slider (CC#18), KnobMod5. [+], KnobMod6. [+], KnobMod7. [+], KnobMod8. [+], Damper (CC#64), Porta.SW (CC#65), Sostenuito (CC#66), Soft (CC#67), SW1 Mod. (CC#80), SW2 Mod. (CC#81), Controller (CC#83), VJS +X Mod. (CC#85), VJS -X Mod. (CC#86), VJS +Y Mod. (CC#87), VJS -Y Mod. (CC#88).

**\*4** A dedicated parameter is also provided for controlling Pitch from the Ribbon.

**\*5** It is possible to control LFO "Frequency" by using Tempo AMS and "Intensity." However if you use the Frequency MIDI/Tempo Sync function (Program 5-1c), the LFO frequency can be synchronized to the tempo and note value.

## The effects of AMS on various parameters, and example applications

Using as HD-1 program as an example, we'll describe some examples of using alternate modulation.

### Pitch (Program 2-2a)

Pitch can be controlled by the wave sequence's AMS Out, Common LFO, filter/amp EG, controllers, or tempo etc.

- If you select Filter EG or Amp EG as the AMS and set "Intensity" to +12.00, the pitch will change up to ±1 octave in synchronization with the EG.
- If you select Tempo as the AMS and set "Intensity" to +12.00, doubling the tempo (based on ♩=120bpms) will raise the pitch one octave, and halving the tempo will lower the pitch one octave.

### Pitch EG Intensity (Program 2-2b)

Pitch EG intensity can be controlled by the wave sequence's AMS Out, Common LFO, keyboard tracking, controllers, or tempo.

- If you select JS +Y:CC#01 as the AMS and set "Intensity" to +12.00, moving the joystick in the +Y direction will gradually increase the effect of the Pitch EG to a maximum of ±1 octave. If "Intensity" has a negative value, the effect of the Pitch EG will be inverted.

### Pitch LFO 1/2 Intensity (Program 2-2c)

Pitch modulation intensity of the LFO1/2 can be controlled by the wave sequence's AMS Out, Common LFO, an EG, keyboard tracking, controllers, or tempo etc.

- If you select EG as the AMS, the pitch change width of LFO modulation etc. can be controlled in synchronization with the level changes of the EG. With positive (+) settings of "Intensity," the vibrato effect will gradually deepen as the EG level rises, or gradually lessen as the EG level decreases. With negative (-) settings of "Intensity," the LFO phase will be inverted.
- If you select a controller such as SW1 or 2 as the AMS, you can press the SW1 or SW2 switch when desired to turn on the vibrato effect.

### Filter (Cutoff) Frequency (Program 3-1b)

The cutoff frequency of filter A/B can be controlled by the wave sequence's AMS Out, pitch/amp EG, Common keyboard tracking, controllers, or tempo. Set AMS and "Intensity" for Filter A or B.

- If you select JS X or Ribbon:CC#16 as the AMS and set "Intensity" to a positive (+) value, moving the joystick or ribbon controller toward the right will raise the cutoff frequency, and moving it toward the left will lower the cutoff frequency. Negative (-) settings will have the opposite effect.
- If you select the same controller as an AMS and set separate intensities for Filter A (Low Pass Filter) "Intensity" and Filter B (High Pass Filter) "Intensity," you can operate a single controller to simultaneously control the cutoff frequencies of both filters.

### Resonance (Program 3-1b)

You can use the wave sequence's AMS Out, EG, LFO, keyboard tracking, controllers, or tempo etc. to control the resonance level.

- If you select Filter Key Track or Amp Key Track as the AMS, you can use the filter or amp keyboard tracking settings to control the resonance level. For example if the amp keyboard tracking parameters "Ramp Bottom-Low" and "Ramp High-Top" are set to positive (+) values, Amp Key Track is selected as the AMS, and "Intensity" it set to a positive (+) value, playing toward either end of the keyboard will cause amp keyboard tracking to increase the volume, and AMS to raise the resonance level.

- You can select a controller as the **AMS**, and apply resonance when desired by operating the controller.
- You can select Common LFO, LFO1 or 2 as the **AMS**, and use the LFO to control the resonance level.

### Output Level (Program 3–1b)

You can use the wave sequence's AMS Out, EG, LFO, keyboard tracking, controllers, or tempo etc. to control the output level of Filter A/B.

- Set the Filter Routing to Parallel, and specify the desired Type and other settings for Filter A and Filter B. Set the **AMS** to LFO for Filter A and Filter B, and set the LFO to +99 and -99 respectively. The output of Filter A and Filter B will be cyclically faded-in/out by the LFO.

### Filter EG Intensity (Program 3–2b)

Filter EG intensity can be controlled by the Common LFO, Common keyboard tracking, a controller or tempo etc. You can use "Intensity to A" and "Intensity to B" to independently specify the intensity for Filter A and B.

- If you select JS -Y (CC#02) as the **AMS** and set "Intensity to A" and "Intensity to B" to a positive (+) value, moving the joystick in the -Y direction will gradually increase the effect of the Filter EG. If you set "Intensity to A" and "Intensity to B" to a negative (-) value, the effect of the Filter EG will be inverted.
- If you select Ribbon:CC#16 as the **AMS** and set "Intensity to A" and "Intensity to B" to a positive (+) value, operating the ribbon controller toward the right will gradually increase the effect of the Filter EG. Operating the ribbon controller toward the left will gradually increase the effect of the Filter EG with an inverted phase.

### Filter LFO1/2 Intensity (Program 3–3a)

The LFO 1/2 filter modulation intensity can be controlled by the wave sequence's AMS Out, EG, Common LFO, keyboard tracking, controller, or tempo etc. You can use **Intensity to A** and **Intensity to B** to independently specify the intensity for Filter A and B.

- If you select EG as the **AMS**, the auto-wah effect produced by LFO modulation will be controlled by the changes in EG level. If you set **Intensity to A** and **Intensity to B** to a positive (+) value, the wah effect will deepen as the EG level rises, and will lessen as the EG level falls. With negative (-) values of **Intensity to A** and **Intensity to B**, the phase of the LFO will be inverted.
- If you use a controller such as SW1 or 2 as the **AMS**, you can apply the auto-wah effect when desired by pressing the SW1 or SW2 switch.

### Filter Common LFO1/2 (Program 3–3b)

You can use the wave sequence's AMS Out, EG, LFO, keyboard tracking, controllers, or tempo etc. to control the Common LFO filter modulation intensity. You can use **Intensity to A** and **Intensity to B** to specify the intensity separately for Filter A and B.

- You can set **AMS** to a controller, and operate the controller only when desired to control the depth of the filter sweep produced by the Common LFO.

### Driver Drive (Program 4–1a)

#### Driver Low Boost (Program 4–1a)

You can use the wave sequence's AMS Out, EG, LFO, keyboard tracking, controllers, and tempo etc. to control the driver's boost and low boost. Although you can use separate AMS to control these two parameters, it is also effective to control them simultaneously by using controllers such as the REALTIME KNOB. (It is particularly effective to control the filter resonance at the same time. This is also nice for synth bass sounds.)

- If you set **AMS** to Knob Mod.5, and set "Intensity" to a positive (+) value, turning REALTIME KNOB 5 toward the right will raise the drive and low boost level, and turning the knob toward the left will lower these parameters. If you set "Intensity" to a negative (-) value, the opposite result will occur.
- If you set **AMS** to Common LFO, LFO 1, or 2, the drive amount will be controlled cyclically by the LFO.

### Amp (Program 4–2b)

The volume can be controlled by the wave sequence's AMS Out, pitch/filter EG, Common LFO, controllers, or tempo etc.

- If an EG or controller that changes with a positive (+) value (EXT(+)) is selected as the **AMS**, setting the "Intensity" to +99 will allow you to increase the volume to a maximum of eight times that of the current volume.
- If an EG, LFO, or controller that changes with a ± value (Pitch EG, Filter EG, LFO, KT, EXT(+/-)) is selected as the **AMS**, setting the "Intensity" to +99 will allow you to increase the volume to a maximum of eight times that of the current volume (for positive (+) changes of the **AMS**), or to decrease the volume to zero (for negative (-) changes of the **AMS**).
- In addition to the time-variant changes in volume produced by the amp EG, you can also make the volume change in synchronization with the pitch/filter EG. Select Pitch EG or Filter EG as the **AMS**, and adjust "Intensity." If you wish to cancel the effect of the Amp EG and use the pitch/filter EG to control the volume, set all levels of the Amp EG to +99.

### Amp LFO1/2 Intensity (Program 4–2c)

The amp modulation intensity of LFO 1/2 can be controlled by the wave sequence's AMS Out, EG, Common LFO, keyboard tracking, controllers, or tempo etc.

- If you select EG as the **AMS**, the depth of the tremolo effect produced by LFO modulation will change in synchronization with the changes in EG level. If you set "Intensity" to a positive (+) value, the tremolo effect will deepen as the EG level rises, and lessen as the EG level falls. If "Intensity" is set to a negative (-) value, the phase of the LFO will be inverted.

- If select a controller such as SW1 or 2 as the AMS, you can apply the tremolo effect by pressing the SW1 or SW2 switch when desired.

#### Pan (Program 4–1c)

The oscillator pan can be controlled by the wave sequence's AMS Out, EG, LFO, keyboard tracking, controllers, or tempo etc.

- If you select Note Number as the AMS and set "Intensity" to +50, panning will be controlled by the keyboard position: center at the C4 note, far right at C6 or above, and far left at C2 or below.
- If EG is selected as the AMS, the oscillator pan will be controlled in synchronization with the changes in EG level. If "Intensity" is set to a positive (+) value, the pan will move toward the right as the EG level increases, and toward the left as the EG level decreases. If "Intensity" is set to a negative (-) value, the opposite effect will occur.

#### EG Reset —

##### Pitch EG (Program 2–9a)

##### Filter EG (Program 3–4a)

##### Amp EG (Program 4–3a)

You can use the wave sequence's AMS Out, EG, LFO, keyboard tracking, controllers, or tempo etc. to control EG Reset. Use the Threshold setting to specify the AMS value at which result will occur.

- By setting AMS to Common LFO, you can reset the envelope cyclically at the interval of the Common LFO. The result is just as if the shape specified by the envelope were being used as a special LFO.
- You can reset the envelope by setting AMS to a controller such as JS+Y, and operating the controller when desired, producing a one-shot filter envelope sweep.

#### EG Level —

##### Pitch EG (Program 2–9c)

##### Filter EG (Program 3–4c)

##### Amp EG (Program 4–3c)

EG levels can be controlled by the wave sequence's AMS Out, Common LFO, keyboard tracking, controllers, or tempo etc.

You can specify an "Intensity" value for each EG segment ("Start," "Attack," "Break"). If you set the "Intensity" value to +66, you will be able to control the respective level over a maximum range of ±99.

- Set AMS to Velocity for Amp EG Level Modulation, Intensity "Start" to +00, "Attack" to +66, and "Break" to -66.  
Set all Amp EG levels to +00. As you play with increasing velocity, the EG levels will change more greatly. At the maximum velocity, the Start Level will stay at +00, but the Attack Level will change to +99 and the Break Level will change to -99.

#### EG Time —

##### Pitch EG (Program 2–9d)

##### Filter EG (Program 3–4d)

##### Amp EG (Program 4–3d)

EG times can be controlled by the wave sequence's AMS Out, Common LFO, keyboard tracking, controllers, or tempo etc.

You can specify an "Intensity" value for each EG segment ("Attack," "Decay," "Slope," "Release"). EG times are determined by the Alternate Modulation value when the preceding point is reached. For example, the Alternate Modulation value at the moment the envelope reaches the attack level will determine the decay time.

If "Intensity" is set to a value of 8, 17, 25, 33, 41, or 49, the corresponding time can be multiplied by a maximum of 2, 4, 8, 16, 32, or 64 times (or divided by 1/2, 1/4, 1/8, 1/16, 1/32, 1/64).

- Select JS +Y:CC#01 for "AMS," and set "AMS Intensity" to +8, "At" to +, "Dc" to -, and "Sl" and "RI" to 0. When you move the joystick in the +Y direction, the Attack Time will be lengthened by a maximum of 2 times. The Decay Time will be shortened by a maximum of 1/2. The Slope and Release times will not change.

#### LFO Frequency (Program 5–1a)

The frequency of LFO 1, 2 or Common LFO can be controlled by the wave sequence's AMS Out, EG, keyboard tracking, controllers, or tempo etc. You can also use the LFO2 frequency to modulate LFO1, or use the Common LFO frequency to modulate LFO 1/2.

If "Intensity" is set to a value of 16, 33, 49, 66, 82, or 99, the corresponding frequency can be multiplied by a maximum of 2, 4, 8, 16, 32, or 64 times (or divided by 1/2, 1/4, 1/8, 1/16, 1/32, 1/64).

- Select JS +Y:CC#01 for "AMS," and set "Intensity" to +16. When you move the joystick in the +Y direction, the LFO frequency will be increased by a maximum of 2 times. If you set "Intensity" to -16 and move the joystick in the +Y direction, the LFO frequency will be decreased by up to 1/2.

#### LFO Frequency AMS Intensity

You can use the wave sequence's AMS out, EG, keyboard tracking, controllers, or tempo etc. to control the intensity of the AMS that controls the frequency of the LFO 1, 2, or Common LFO.

For example if you're using the pitch EG to modulate the LFO frequency, you could use a separate AMS to control the depth of this effect.

- Set AMS to a controller such as SW 1 or 2, so that the pitch EG will lightly control the LFO frequency when the switch is off, and more deeply when the switch is on.

#### LFO Shape

You can use a wave sequence's AMS Out, EG, keyboard tracking, controllers, or tempo etc. to control the shape of the LFO 1, 2, or Common LFO waveform.

You can also use the LFO2 frequency to modulate LFO1, or use the Common LFO frequency to modulate LFO 1/2.

- You can control the LFO waveform by setting **AMS** to a controller such as JS+Y, and operating the controller when desired.

### **Common LFO Reset (Program 5–9a)**

You can use a controller or tempo etc. to reset the Common LFO.

- By setting **AMS** to Gate 1, you can make the Common LFO reset when a note is played from a state in which all notes are off. For example, this will ensure that a filter sweep always starts from the same place.
- You can set **AMS** to a controller such as JS+Y, and operate the controller when you want to reset the LFO.

## Dynamic Modulation Sources (Dmod)

### Overview

You can control certain effect parameters using the joystick, vector joystick, ribbon controller, etc. “on the fly.”

These parameters can also be controlled by KARMA, the Vector joystick and EG, or the sequencer.

Controlling effects in this way is referred to as Dynamic Modulation. For example, you can use After Touch to speed up the LFO of the chorus and flanger, or you can use the ribbon controller to sweep a wah effect. This lets you take full advantage of the effects as part of the expressive potential of your instrument.

Most of the parameters for dynamic modulation consist of parameter values for **Source** and **Amount**. The **Source** field selects the modulation source, and **Amount** sets the modulation intensity. When the **Source** is at its maximum value (for instance, when JS+Y is moved all the way up), the actual degree of the effect will be the parameter value plus the **Amount**.

For example, let's say that **Wet/Dry** = 10:90, **Source** = After Touch, and **Amount** = +50.

With no After Touch, the wet/dry balance is 10:90 (mostly dry). As you apply After Touch, the balance will change to include more of the effect sound, and less of the dry sound. When After Touch is at its maximum, the wet/dry balance will be 60:40 (more wet than dry).

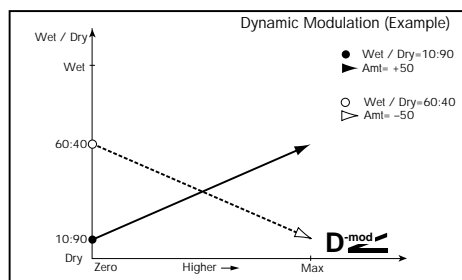

See the individual effects descriptions for explanations of other dynamic modulation parameters. Parameters which can be controlled through dynamic modulation are marked by the **D<sup>mod</sup>** symbol.

### Dmod and MIDI

**MIDI** In Program and Sampling modes, dynamic modulation is always controlled via the global MIDI Channel.

In Combination and Sequencer modes, dynamic modulation is controlled via the MIDI channel independently specified by the “Ch” for IFX1–12, MFX1, 2, and TFX1, 2.

## Dynamic Modulation Source List

Off	dynamic modulation is not used
Gate1	note on/off <sup>p.1102</sup>
Gate1+Damper	note on + damper on/off <sup>p.1102</sup>
Gate2	note on/off (retrigger) <sup>p.1102</sup>
Gate2+Damper	note on + damper on/off (retrigger) <sup>p.1102</sup>
Note Number	note number
Velocity	Velocity
Exponential Velocity	exponential velocity <sup>p.1102</sup>
After Touch	after touch (Channel After Touch)
JS X	joystick X (horizontal) direction
JS+Y (CC#01)	joystick +Y (Vertical upward) direction (CC#01)
JS-Y (CC#02)	joystick -Y (Vertical downward) direction (CC#02)
Foot Pedal (CC#04)	assignable foot pedal (CC#04) <sup>p.1102</sup>
FX Control1 (CC#12)	MIDI effect control 1 (CC#12)
FX Control2 (CC#13)	MIDI effect control 2 (CC#13)
Ribbon (CC#16)	ribbon controller (CC#16)
Value Slider (CC#18)	value slider (CC#18) <sup>p.1102</sup>

Knob Mod.5 (CC#17)	realtime control knob 5 (knob modulation 5 CC#17) <sup>p.1102</sup>
Knob Mod.6 (CC#19)	realtime control knob 6 (knob modulation 6 CC#19) <sup>p.1102</sup>
Knob Mod.7 (CC#20)	realtime control knob 7 (knob modulation 7 CC#20) <sup>p.1102</sup>
Knob Mod.8 (CC#21)	realtime control knob 8 (knob modulation 8 CC#21) <sup>p.1102</sup>
Knob Mod.5 [+]	realtime control knob 5 [+] <sup>p.1102</sup>
Knob Mod.6 [+]	realtime control knob 6 [+] <sup>p.1102</sup>
Knob Mod.7 [+]	realtime control knob 7 [+] <sup>p.1102</sup>
Knob Mod.8 [+]	realtime control knob 8 [+] <sup>p.1102</sup>
Damper (CC#64)	damper pedal (CC#64)
Porta. SW (CC#65)	portamento switch (CC#65)
Sostenuto (CC#66)	sostenuto pedal (CC#66)
Soft (CC#67)	soft pedal (CC#67)
SW1 Mod. (CC#80)	assignable panel switch 1 (SW1 modulation CC#80) <sup>p.1104</sup>
SW2 Mod. (CC#81)	assignable panel switch 2 (SW2 modulation CC#81) <sup>p.1104</sup>
Foot Switch (CC#82)	assignable foot switch (CC#82) <sup>p.1106</sup>
Controller (CC#83)	MIDI Control Change (CC#83)

VJS +X Mod.(CC#85)	Vector joystick +X (VJS modulation +X CC#85) <small>ESP</small> p.1102
VJS -X Mod.(CC#86)	Vector joystick -X (VJS modulation -X CC#86) <small>ESP</small> p.1102
VJS +Y Mod.(CC#87)	Vector joystick +Y (VJS modulation +Y CC#87) <small>ESP</small> p.1102
VJS -Y Mod.(CC#88)	Vector joystick -Y (VJS modulation -Y CC#88) <small>ESP</small> p.1102
Tempo	tempo (internal clock or external MIDI clock tempo data) <small>ESP</small> p.1103

**Gate1, Gate1+Damper**

The effect is at maximum during note-on, and will stop when all keys are released. With Gate1 + Damper, the effect will remain at maximum even after the keys are released, as long as the damper (sustain) pedal is pressed.

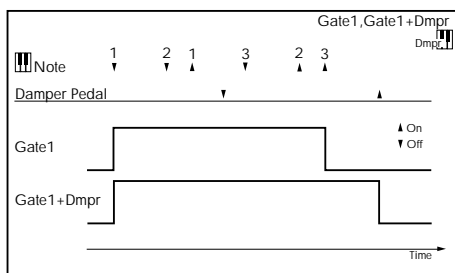

**Gate2, Gate2+Damper**

This is essentially the same as for Gate 1 or Gate 1 + Damper. However when Gate 2 or Gate 2 + Damper are used as a dynamic modulation source for the EG of 050: Stereo Envelope Flanger etc. or the AUTOFADE of 055: Stereo Vibrato, a trigger will occur at each note-on. (In the case of Gate 1 and Gate 1 + Damper, the trigger occurs only for the first note-on.)

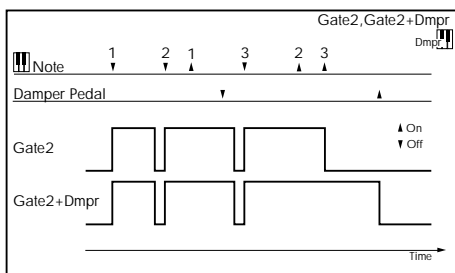

**Exponential Velocity**

Modulation will be applied exponentially according to the velocity value. Weak velocity values will produce little effect, but the effect will increase rapidly as the velocity values rise.

**Foot Pedal (CC#04)**

If you wish to use the assignable foot pedal as a dynamic modulation source, set “Foot Pedal Assign” (Global P2: Controller 2-1a) to Foot Pedal (CC#04). (See “Foot Pedal Assignments” on page 1108)

A foot controller etc. connected to the ASSIGNABLE PEDAL jack can be used to control an effect.

**Value Slider: CC#18**

When Program mode P0 Main “Program Select” or Combination mode P0 Main “Combination Select” are selected, the VALUE slider will function as a controller corresponding to CC#18.

**Knob Mod.5 (CC#17)**

**Knob Mod.6 (CC#19)**

**Knob Mod.7 (CC#20)**

**Knob Mod.8 (CC#21)**

If you want to use REALTIME KNOBS 5-8 as AMS, set the Set Up Controllers page “Modulation Knob Assign” parameters to assign “Knob5” to Knob Mod.5 (CC#17), “Knob6” to Knob Mod.6 (CC#19), “Knob7” to Knob Mod.7 (CC#20), and “Knob8” to Knob Mod.8 (CC#21) (“Realtime Knobs 5-8 Assignments” on page 1105) for each program, combination, song, or for Sampling mode.

You can control the effect by operating REALTIME KNOBS 5-8.

Moving the knob to the 12 o'clock position will produce an AMS effect of 0. If “Amount” is set to a positive (+) value, rotating the knob toward the right will produce a positive change in the effect, and rotating it toward the left will produce a negative change. (With negative (-) settings, the opposite effect will result.)

**Knob Mod.5 [+] (CC#17 [+])**

**Knob Mod.6 [+] (CC#19 [+])**

**Knob Mod.7 [+] (CC#20 [+])**

**Knob Mod.8 [+] (CC#21 [+])**

These differ from Knob Mod.5 (CC#17)-Knob Mod.8(CC#21) in the knob position and direction of the effect. If “Amount” is set to a positive (+) value, rotating the knob to the far left will produce an effect of 0 as the dynamic modulation source. Rotating the knob toward the right will apply an effect only in the positive direction. (With negative (-) settings, the opposite effect will result.)

**SW1 Mod. (CC#80)**

**SW2 Mod. (CC#81)**

If you wish to use the SW1 or SW2 switch as a dynamic modulation source, make settings in Program, Song, or Sampling modes to set the Set Up Controllers page parameter “Panel Switch Assign” to the following values respectively: “SW1” to SW1 Mod. (CC#80), or “SW2” to SW2 Mod. (CC#81) (“SW1/2 Assignments” on page 1104).

The effect will be controlled when you operate the SW1 or SW2 switch.

**Foot Switch (CC#82)**

If you wish to use an assignable foot switch as a dynamic modulation source, set “Foot Switch Assign” (Global 2-1a) to Foot SW (CC#82) (“Foot Switch Assignments” on page 1106).

The effect will be controlled when you operate a foot switch etc. connected to the ASSIGNABLE SWITCH jack.

**VJS +X Mod.(CC#85)**

**VJS -X Mod.(CC#86)**

**VJS +Y Mod.(CC#87)**

**VJS -Y Mod.(CC#88)**

If you want to use the vector joystick as a dynamic modulation source, go to the Vector Control page or Vector CC page for each program, combination, or song, and set the "Vector CC Control" parameters "+X," "-X," "+Y," and "-Y" respectively to VJS +X Mod. (CC#85), VJS -X Mod. (CC#86), VJS +Y Mod. (CC#87), and VJS -Y Mod. (CC#88). (If "VJS X/Y Mode" is Positive or Negative, you'll be able to use either + or -, not both.)

Operate the vector joystick to apply modulation.

*Note:* Dynamic modulation via the vector joystick is not available in Sampling mode.

**Tempo**

The resulting modulation will be zero at 120 BPM, the maximum positive value at 240 BPM, and the maximum negative value at 60 BPM.

Many effects LFOs and delays can also be synchronized to tempo. For more information, see "Tempo Synchronization" on page 859



## Controller Assignments

### SW1/2 Assignments

Switch assignments are saved separately with each Program, Combination, and Song. In Sampling mode, assignments apply to the entire mode. For more information, see:

- HD-1 Programs: “1–8: Set Up Controllers” on page 53
- EXi Programs: “4–8: Set Up Controllers” on page 175
- Combinations: “1–8: Set Up Controllers” on page 451
- Sequencer mode: “1–8: Set Up Controllers” on page 560
- Sampling mode: “4–8: Set Up Controllers” on page 707

#### List of SW 1/2 assignments

The following functions can be assigned to SW1 and SW2.

##### Off

This setting disables the switch.

##### SW1 Mod. (CC#80) and SW2 Mod. (CC#81)

This lets you use the switch as an AMS or Dmod source. Note that you’ll also need to assign SW1 Mod or SW2 Mod to control the desired parameter within the Program or Effect.

Each time the switch is turned on or off, it transmits the corresponding MIDI CC (80 or 81); Off is 0, and On is 127.

##### Portamento SW (CC#65)

This turns Portamento on and off. When the LED is lit, Portamento is on.

Each time the switch is turned on or off, it transmits MIDI CC#65; Off is 0, and On is 127.

With single Programs, this simply enables and disables Portamento, regardless of the of the Program’s stored **Portamento Enable** setting.

With double HD-1 or EXi Programs, it’s slightly more complex. If Portamento is either enabled for both OSC 1 and 2 (or EXi 1 and 2), or off for both, then the Portamento Switch controls both OSC or EXi.

If Portamento is enabled for only one of the two, only that element will be affected by the switch; for the other element, Portamento will always be off.

##### Octave Down

When the switch is on (LED lit), the pitch will be transposed down by one octave.

##### Octave Up

When the switch is on (LED lit), the pitch will be transposed up by one octave.

#### Lock functions

The Lock functions let you use SW1 or SW2 to “lock” the current position of the joystick or ribbon controller, or the current aftertouch value. This leaves your hands free to play on the keyboard, or to use other controllers.

For instance, let’s say that JS+Y is assigned to create a filter sweep, and that SW2 is assigned to JS+Y Lock. You can then:

1. Move the joystick to open up the filter.
2. Press SW2 to turn on JS+Y Lock.
3. Release the joystick.

Since SW2 is locking JS+Y, the filter remains open, even though the joystick has physically snapped back to its center position.

Note that Lock affects only the physical controls. Even if Lock is On, incoming MIDI messages can still change the joystick, ribbon, and aftertouch values.

For more information, see “Using the Lock function” on page 32 of the Operation Guide.

##### JS X Lock

Locks the effect of the joystick X axis.

##### JS Y Lock

Locks the effect of the joystick Y axis (both + and – directions).

##### JS+Y Lock

Locks the effect of the joystick +Y direction.

##### JS–Y Lock

Locks the effect of the joystick –Y direction.

##### Ribbon Lock

Locks the effect of the ribbon controller.

##### JS X & Ribbon Lock

Simultaneously locks the effects of the joystick X direction and the ribbon controller.

##### JS Y & Ribbon Lock

Simultaneously locks the effects of the joystick Y direction and the ribbon controller.

##### JS+Y & Ribbon Lock

Simultaneously locks the effects of the joystick +Y direction and the ribbon controller.

##### JS–Y & Ribbon Lock

Simultaneously locks the effects of the joystick –Y direction and the ribbon controller.

##### After Touch Lock

Locks the effect of after touch.

**Chord SW**

This enables and disables Chord mode. For more information, see “Using Chord mode” on page 36 of the Operation Guide.

---

**Realtime Knobs 5–8 Assignments**

Knob assignments are saved separately with each Program, Combination, and Song. In Sampling mode, assignments apply to the entire mode. For more information, see:

- HD-1 Programs: “1–8: Set Up Controllers” on page 53
- EXi Programs: “4–8: Set Up Controllers” on page 175
- Combinations: “1–8: Set Up Controllers” on page 451
- Sequencer mode: “1–8: Set Up Controllers” on page 560
- Sampling mode: “4–8: Set Up Controllers” on page 707

**Knobs and MIDI CCs**

Some of the assignments include MIDI CCs, which are transmitted whenever the knob is moved. Note that the MIDI CCs can still be received even if they are not assigned to a physical controller.

---

**List of Knob 5-8 assignments**

The following functions can be assigned to REALTIME KNOBS 5–8.

**Off**

This setting disables the knob.

**Knob Mod. 5–8 (CC#s17, 19, 20, 21)**

These settings let you use the knob as an AMS or Dmod source. Note that you’ll also need to assign the knob to control the desired parameter within the Program or Effect.

**Master Volume**

This controls the overall volume, and transmits the Universal System Exclusive Master Volume message [F0H, 7FH, nn, 04, 01, vv, mm, F7H]. You can use this to adjust the volumes of all Tracks or Timbres at the same time, while preserving their relative balance.

For more information, see the diagram under “Master Volume Slider” on page 24.

**Portamento Time (CC#05)**

This controls the portamento time. Note that a different controller, CC#65, turns Portamento on and off; see “Portamento SW (CC#65)” on page 1104.

**Volume (CC#07)**

Controls the volume, and transmits CC#7.

**Post IFX Pan (CC#08)**

Controls the panning after the last Insert Effect in the chain, and transmits CC#8.

**Pan (CC#10)**

Controls stereo pan, and transmits CC#10.

**Expression (CC#11)**

Expression is a secondary volume control, which you can use to scale level without affecting the main volume settings or CC#7 values.

When used one at a time, MIDI Volume and Expression affect level in exactly the same way: a MIDI value of 127 is equal to Program’s main Level setting, and lower values reduce the volume.

If both CC#7 and CC#11 are used simultaneously, the one with the *lower* value determines the maximum volume, and the one with the *higher* value scales down from that maximum.

**FX Control 1 & 2 (CC#s12 & 13)**

These assignments are intended for Effect Dynamic Modulation (Dmod). Note that you’ll also need to assign **FX Control 1** or **2** to control the desired parameter within the Effect.

**LFP Cutoff (CC#74)**

This scales the cutoff frequency of all of the filters at once. For instance, in the HD-1, it affects both Filters A and B.

**Resonance (CC#71)**

This scales the resonance of all of the filters at once. For instance, in the HD-1, it affects both Filters A and B.

**Filter EG Int. (CC#79)**

This scales the effect of the Filter EG on the cutoff frequency. It affects all of the filters at once; for instance, in the HD-1, it affects both Filters A and B.

**F/A Attack (CC#73)**

This scales the attack times of the Filter and Amp EGs, along with other related parameters.

When the CC value is above 64, this also affects the Amp EG’s Start and Attack Levels, Start Level AMS, and Attack Time AMS, as described below:

Between values of 65 and 80, the Start Level, Start Level AMS, and Attack Time AMS will change from their programmed values to 0. Over the same range, the Attack Level will change from its programmed value to 99.

**F/A Decay (CC#75)**

This scales the decay and slope times of the Filter and Amp EGs.

**F/A Sustain (CC#70)**

This scales the sustain levels of the Filter and Amp EGs.

### **F/A Release (CC#72)**

This scales the release times of the Filter and Amp EGs.

### **Pitch LFO1 Spd (CC#76)**

This scales LFO1's frequency.

### **Pitch LFO1 Dep (CC#77)**

This scales the effect of LFO1 on the Pitch.

### **Pitch LFO1 Dly (CC#78)**

This scales LFO1's fade-in time.

### **SW 1 Mod. & SW 2 Mod (CC#s 80 & 81)**

Normally, these are used for the two assignable switches - but you can assign them to the knobs instead, if you like.

### **Foot Switch (CC#82)**

You can use this general-purpose controller as an AMS or Dmod source. Note that you'll also need to assign **Foot Switch (CC#82)** to control the desired parameter within the Program or Effect.

### **MIDI CC#83 (CC#83)**

You can use this general-purpose controller as an AMS or Dmod source. Note that you'll also need to assign **Controller #83** to control the desired parameter within the Program or Effect.

### **MFx Send 1 & 2 (CC#s 93 & 91)**

These control the send levels to Master Effects 1 and 2, respectively.

CC#s 93 and 91 actually control send levels in two different places: the sends directly from the Program OSC or EXi, and the send levels of the last Insert Effect in the chain which matches the CC's MIDI channel.

### **MIDI CC#00-95 and 102-119**

These settings let you transmit any MIDI CC, except for registered and non-registered parameters (CCs 96-101). If you choose a CC which is used by AMS, Dmod, or the standard CC routings, then it will affect the corresponding KRONOS parameters.

---

## **Knobs 1-4**

REAL TIME KNOBS 1-4 have preset assignments, as below:

### **Knob1: LPF CUTOFF (Filter Cutoff: CC#74)**

This scales the cutoff frequency of all of the filters at once. For instance, in the HD-1, it affects both Filters A and B.

### **Knob2: RESONANCE (Filter Resonance: CC#71)**

This scales the resonance of all of the filters at once. For instance, in the HD-1, it affects both Filters A and B.

### **Knob3: EG INTENSITY (Filter EG Intensity: CC#79)**

This scales the effect of the Filter EG on the cutoff frequency. It affects all of the filters at once; for instance, in the HD-1, it affects both Filters A and B.

### **Knob4: EG RELEASE (Filter, Amplifier EG Release: CC#72)**

This scales the release times of the Filter and Amp EGs.

---

## **Foot Switch Assignments**

You can connect a footswitch (such as the optional Korg PS-1) to the rear-panel ASSIGNABLE SWITCH input, and then use it to control a wide variety of functions, as described below.

This setting is made globally, on the Global P2-1 Controller page.

### **Foot Switch and MIDI CCs**

Some of the assignments include MIDI CCs, which are transmitted each time the switch is turned on or off (Off = 0, and On = 127). Note that the MIDI CCs can still be received even if they are not assigned to a physical controller.

RT Knobs 5-8 and SW1/2 are special cases, since these can themselves be assigned to different MIDI CCs. If the footswitch is assigned to duplicate these controls, it will also use their CC assignments.

---

## **List of Foot Switch assignments**

### **Off**

This setting disables the switch.

### **Foot Switch (CC#82)**

This lets you use the switch as an AMS or Dmod source. Note that you'll also need to assign Foot Switch (CC#82) to control the desired parameter within the Program or Effect.

### **Portamento SW (CC#65)**

This controls portamento on/off. For more information, see "Portamento SW (CC#65)" on page 1104.

### **Sostenuto (CC#66)**

This controls the sostenuto effect, which holds only the notes being played at the moment that the footswitch is turned on.

### **Soft (CC#67)**

Turns the soft pedal effect on and off.

### Program Up

This lets you use the switch to increment the current Program, Combination, or Set List Slot number, for hands-free patch changes. Note that this is only active while on the Program P0:Play or Combination P0:Play pages, respectively, or while in Set List mode.

When you use this control, the KRONOS will also transmit the corresponding MIDI Program Change and Bank Select messages.

### Program Down

This decrements the current Program, Combination, or Set List Slot number, for hands-free patch changes. For more information, see "Program Up," above.

### Song Start/Stop

The switch can be used to start/stop the sequencer. Simultaneously, a MIDI Start or Stop message will be transmitted.

### Song Punch In/Out

If Sequencer P0: Preference "Recording Setup" (0–5a) is set to Manual Punch In, the switch can be used to punch-in and punch-out when recording on the sequencer.

### Tap Tempo

This duplicates the function of the front-panel TAP TEMPO button, for setting the system tempo in real-time.

### KARMA ON/OFF

The foot switch will turn KARMA on/off.

### KARMA LATCH ON/OFF

The foot switch will turn KARMA LATCH on/off.

### KARMA SCENE

The foot switch will cycle through KARMA scenes. The next scene will be selected each time you press the foot switch.

### JS+Y (CC#01)

The switch will control the effect produced by joystick movement in the +Y direction (Vertical upward).

### JS-Y (CC#02)

The switch will control the effect produced by joystick movement in the -Y direction (Vertical downward).

### Ribbon (CC#16)

The switch duplicates the effect of the ribbon controller.

### Value Slider (CC#18)

The switch will control the effect of the VALUE slider.

### RT Knob1–8

The switch duplicates the function of the selected REALTIME KNOB. When the switch is on, it produces the same effect as when the knob is rotated fully to the right; when it is Off, it produces the same effect as when the knob is rotated fully to the left.

### SW1, 2

The footswitch duplicates the function of the selected front-panel switch.

### KARMA RTC Slider1–8

The foot switch will control the effect of the KARMA CONTROLS (slider).

### KARMA RTC SW1–8

The foot switch will control the effect of the KARMA SWITCHES.

### PAD1–8

This lets you trigger any of the Pads from the foot switch. When playing notes, the footswitch triggers the pad as if it had been hit at maximum velocity. Note that this can also be used to select a chord, when Chord mode is on.

### Value Inc

The switch will duplicate the function of the front-panel Inc  $\triangle$  button. For more information, see "Using a footswitch to select Programs" on page 29 of the Operation Guide.

### Value Dec

The switch will duplicate the function of the front-panel Dec  $\nabla$  button.

### Chord SW

This enables and disables Chord mode. For more information, see "Using Chord mode" on page 36 of the Operation Guide.

### D.TRACK ON/OFF

The foot switch will turn the Drum Track on and off, duplicating the functionality of the front-panel DRUM TRACK button.

## Foot Pedal Assignments

You can connect a pedal (such as the optional Korg XVP-10 or EXP-2) to the rear-panel ASSIGNABLE PEDAL input, and then use it to control a wide variety of functions, as described below.

This setting is made for the entire KRONOS, on the Global P2-1 Controller page.

### A note on MIDI CCs

Some of the assignments include MIDI CCs, which are transmitted whenever the knob is moved. Note that the MIDI CCs can still be received even if they are not assigned to a physical controller.

RT Knobs 5-8 and SW1/2 are special cases, since these can themselves be assigned to different MIDI CCs. If the footswitch is assigned to duplicate these controls, it will also use their CC assignments.

---

### List of Foot Pedal assignments

#### Off

This setting disables the pedal.

#### Master Volume

This controls the overall volume, and transmits the Universal System Exclusive Master Volume message [F0H, 7FH, nn, 04, 01, vv, mm, F7H]. You can use this to adjust the volumes of all Tracks or Timbres at the same time, while preserving their relative balance.

For more information, see the diagram under “Master Volume Slider” on page 24.

#### Foot Pedal (CC#04)

You can use this general-purpose controller as an AMS or Dmod source. Note that you’ll also need to assign **Foot Pedal (CC#04)** to control the desired parameter within the Program or Effect.

#### Portamento Time (CC#05)

Controls the speed at which portamento will change the pitch.

#### Volume (CC#07)

Control the volume of a Program, Combination, or of a MIDI track in Sequencer modes.

#### Post IFX Pan (CC#08)

Control the pan after passing through the Insert Effect.

#### Pan (CC#10)

Control the pan of a Program, of a timbre in a Combination, or of a MIDI track in Sequencer modes.

#### Expression (CC#11)

Expression is a secondary volume control, which you can use to scale level without affecting the main volume settings or CC#7 values. For more information, see “Expression (CC#11)” on page 1105.

#### FX Control 1 & 2 (CC#s12 & 13)

These assignments are intended for Effect Dynamic Modulation (Dmod). Note that you’ll also need to assign **FX Control 1** or **2** to control the desired parameter within the Effect.

#### MFX Send 1 & 2 (CC#s 93 & 91)

These control the send levels to Master Effects 1 and 2, respectively.

CC#s 93 and 91 actually control send levels in two different places: the sends directly from the Program OSC or EXi, and the send levels of the last Insert Effect in the chain which matches the CC’s MIDI channel.

#### JS+Y (CC#01)

This duplicates the function of JS+Y. Whatever JS+Y is assigned to control, the pedal will control as well.

#### JS-Y (CC#02)

This duplicates the function of JS-Y. Whatever JS-Y is assigned to control, the pedal will control as well.

#### Ribbon (CC#16)

This duplicates the function of the ribbon controller. Whatever the ribbon is assigned to control, the pedal will control as well.

#### Value Slider (CC#18)

Pedal operation will control the effect of the VALUE slider.

#### RT Knob 1-8

This duplicates the function of the selected REAL TIME KNOB. Whatever the knob is assigned to control, the pedal will control as well.

#### KARMA RTC Slider1-8

This duplicates the function of the selected KARMA SLIDER. Whatever the slider is assigned to control, the pedal will control as well.

## Dynamic MIDI Sources & Destinations

### Dynamic MIDI Sources

The sources (Dynamic MIDI Sources) are organized into the following groups

JS +Y #01...JS X: Controller group

Short Note...Black Note: Note group

Velocity...Vel Out Z: Velocity Group

Depending on the combination of source and destination (Dynamic MIDI Destinations), the selected destination may not function as you intend. Refer to the explanations of combining sources and destinations in each section of "Dynamic MIDI Destinations," and make sure to select sources and destinations that are appropriate for each other.

Off: No source will be selected.

#### Controller Group:

For the Controller Group, the Range Bottom and Top fields will be available. The Range fields can be used to choose only a portion of the normal 0–127 range if desired. This depends on whether the actual Source is a continuous controller or a switch. For example, if you choose JS+Y (CC#01) and set the range to be 110–127, then only when the joystick reaches the farthest position away from yourself would the selected Destination be affected. In most cases, you should leave them set to 0–127 for normal operation, unless you are trying to achieve a special calculated effect in only a portion of the controller's range.

The following Controller Group Sources correspond to the KARMA ON/OFF switch, KARMA LATCH switch, KARMA SCENE 1–8, KARMA SLIDERS 1–8, KARMA SWITCH 1–8, Pads 1–8, and the CCs they are set to respond to on the Global 2–1: Controllers/Scales page. Shown are the default CC settings. If the Global 1–1b: MIDI Filter "Enable Control Change" is checked and a MIDI CC Message is received on the assigned controller, it will control the Dynamic MIDI Assignment as well as the associated control.

Two settings are "special," in that they refer to groups of controls: KARMA Scene-Any, and Pads-Any. When these are selected, the operation of any KARMA SCENE switch or any Pads 1–8 respectively can be intercepted and used as a Dynamic MIDI Source.

While all of the Real-Time Controls are able to be assigned in their normal operation to do various things, there are times where using them through Dynamic MIDI can be useful. For example, the KARMA SCENE switches can be used to retrigger the groove at a scene change, stop any melodic repeats so that they don't overlap the scene change, or change a parameter value in the Real-Time Parameters of a GE, etc. Pads can be set to repeatedly trigger modules each time they are pressed, yet the module can be in "1st" Trigger Mode, so that playing the keyboard doesn't retrigger the start of the groove. And the Latch switch could be used to change the Key Zone range or the Latch Mode for a module's envelopes.

Furthermore, by running a KARMA SLIDER through Dynamic MIDI and into Real-Time Parameter Control, rather than assigning it to an Real-Time Parameter directly, you can choose only a portion of the slider's range to affect the parameter. For example, if you selected KARMA SLIDER 1 as a Dynamic MIDI Source, and set the Bottom/Top to 110/127, then only at the end of the slider will the slider's values affect any destination parameters assigned through Real-Time Parameters Control.

#### JS+Y (CC#01)

The +Y direction (away from yourself) of the joystick (CC#01) will be the source.

#### JS-Y (CC#02)

The –Y direction (toward yourself) of the joystick (CC#02) will be the source.

#### Pedal (CC#04)

The assignable foot pedal (CC#04) will be the source.

The function of the assignable pedal connected to the ASSIGNABLE PEDAL jack must be assigned as Foot Pedal (CC#04) for the Global 2–1: Controllers/Scales page "Foot Pedal Assign" parameter.

#### Damper (CC#64)

The damper pedal will be the source.

#### Porta. SW (CC#65)

The portamento switch (CC#65) will be the source.

#### Foot Switch (CC#82)

The assignable foot switch (CC#82) will be the source.

The function of the assignable foot switch connected to the ASSIGNABLE SWITCH jack must be assigned as Foot Switch (CC#82) for the Global 2–1: Controllers/Scales page "Foot SW Assign" parameter.

#### MIDI (CC#83)

MIDI control change CC#83 will be the source.

#### Ribbon (CC#16)

The ribbon controller (CC#16) will be the source.

#### VJS X (CC#118)

The X (horizontal) direction of the vector joystick (CC#118) will be the source.

*Note:* If you want to use the ±X axis of the vector joystick as a source, set the Global P2–1c: MIDI CC# Assign-Vector Joystick/Pads parameter "VJS X" to CC#118.

#### VJS Y (CC#119)

The Y direction (vertical) of the vector joystick (CC#119) will be the source.

*Note:* If you want to use the  $\pm X$  axis of the vector joystick as a source, set the Global P2-1c: MIDI CC# Assign-Vector Joystick/Pads parameter "VJS X" to CC#119.

### VJS +X Mod. (CC#85)

The +X direction (the left direction) of the vector joystick (CC#85) will be the source.

*Note:* If you want to use the +X axis of the vector joystick as a source, set the P1-5b: Vector CC Control parameter "+X" to CC#85 for the desired program, combination, or song.

### VJS -X Mod. (CC#86)

The -X direction (the right direction) of the vector joystick (CC#86) will be the source.

*Note:* If you want to use the -X axis of the vector joystick as a source, set the P1-5b: Vector CC Control parameter "-X" to CC#86 for the desired program, combination, or song.

### VJS +Y Mod. (CC#87)

The +Y direction (away from yourself) of the vector joystick (CC#87) will be the source.

*Note:* If you want to use the +Y axis of the vector joystick as a source, set the P1-5b: Vector CC Control parameter "+Y" to CC#87 for the desired program, combination, or song.

### VJS -Y Mod. (CC#88)

The -Y direction (toward from yourself) of the vector joystick (CC#88) will be the source.

*Note:* If you want to use the -Y axis of the vector joystick as a source, set the P1-5b: Vector CC Control parameter "-Y" to CC#88 for the desired program, combination, or song.

### KARMA On/Off\*

The KARMA ON/OFF switch will be the source.

### KARMA Latch\*

The corresponding KARMA LATCH switch will be the source.

### KARMA Slider 1...8\*

The corresponding KARMA SLIDER 1-8 will be the source.

### KARMA SWITCH 1...8\*

The KARMA SWITCH 1-8 will be the source.

### KARMA Scene 1...9, KARMA Scene-Any

\*The KARMA SCENE 1-9 will be the source.

If you choose KARMA Scene-Any, the switch you operated will be the source.

\***Note:** If a MIDI control change is assigned in the Global 2-1: Controllers/Scales page, this will be controlled by reception of the assigned MIDI control change.

### Pad 1...8, Pad-Any (CC110...117, Note Number)

The Pads 1-8 will be the source.

If you choose Pad-Any, the pad you operated will be the source.

*Note:* If a MIDI control change or Note Number is assigned in the Global 2-1: Controllers/Scales page, this will be controlled by reception of the assigned MIDI control change or Note Number. The default values are shown.

### AfterT

Aftertouch (channel aftertouch) will be the source.

### JS X

The X (horizontal) direction of the joystick will be the source.

For JS X, **Polarity** (7-7b) allows you to select +/- or -/+ in addition to the usual + or - operations.

When the controller is moved all the way to the left or right (or top or bottom), the value will change as follows. The example shown below is for when Tempo is selected as the destination. (Original tempo is  $\text{♩}=100$  BPM, "Bottom/Top": 000/127)

+: Far left (0) -> far right (maximum)

100 BPM -> 200 BPM

-: Far left (0) -> far right (maximum)

100 BPM -> 50 BPM

+/-: Far left (minimum) -> center (0) -> far right (maximum)

50 BPM -> 100 BPM -> 200 BPM

-/+: Far left (maximum) -> center (0) -> far right (minimum)

200 BPM -> 100 BPM -> 50 BPM

---

## Note Group:

When using the Note Group Sources, **Bottom** and **Top**(7-7b) refer to MIDI Note Numbers C-1...G9:

000: C-1...012: C0...024: C1...036: C2...

045: C3...060: C4...072: C5...084: C6...

096: C7...108: C8...120: C9...127: G9

### Short Note

Use **Bottom** and **Top** (7-7b) to specify the range of note numbers. Only notes within the specified range with a duration of less than 45 ms between note-on and note-off will be the source.

### Note

Use **Bottom** and **Top** (7-7b) to specify the range of note numbers. Notes within the specified range will be the source. (≡Short Note)

### Note Inside Zone

Notes within the key zone of the KARMA module (Program 7-1b, Combination 7-1c, Sequencer 7-1c) will be the source.

Use "Input" to specify the applicable KARMA module.

### Note Outside Zone

Notes outside the key zone of the KARMA module (Program 7-1b, Combination 7-1c, Sequencer 7-1c) will be the source.



Use "Input" to specify the applicable KARMA module.

**White Note**

Use **Bottom** and **Top** (7-7b) to specify the range of note numbers. Only the white notes (C, D, E, F, G, A, B) within the specified range will be the source.

**Black Note**

Use **Bottom** and **Top** (7-7b) to specify the range of note numbers. Only the black notes (C#, D#, F#, G#, A#) within the specified range will be the source.

**Velocity Group:**

**Velocity**

Velocity values will be the source. Use **Bottom** and **Top** (7-7b) to specify the velocity range.

**Velocity Inside Zone**

Velocity values of notes within the key zone of the KARMA module (Program 7-1b, Combination 7-1c, Sequencer 7-1c) will be the source.

Use **Bottom** and **Top** (7-7b) to specify the velocity range. Use "Input" to specify the applicable KARMA module.

**Velocity Outside Zone**

Velocity values of notes outside the key zone of the KARMA module (Program 7-1b, Combination/Sequencer 7-1c) will be the source.

Use **Bottom** and **Top** (7-7b) to specify the velocity range. Use "Input" to specify the applicable KARMA module.

**Dynamic MIDI Destinations**

KARMA allows you to hook up nearly any Source to any Destination. Depending on the combination of source and destination, the selected destination may not function as you intend. Refer to the explanations of combining sources and destinations in each of the following sections, and make sure to select sources and destinations that are appropriate for each other.

The Momentary, Toggle, Continuous indication shown at the right of each destination name indicate the source operating modes ("Action") that are valid for each destination function. For more information, see "Action (Source Action)" on page 128.

**Off**

No function

**RT Parm's Control [Momentary, Toggle, Continuous]**

Use this when using a source to control GE Real-Time Parameters (7-5) or Perf Real-Time Parameters (7-6). Set the "Assign" of GE Real-Time Parameters or Perf Real-Time Parameters to DynaMIDI1...DynaMIDI8, which indicates the row of the Dynamic MIDI page that is to be used. For more information, see "ASSIGN" on page 121.

*Note:* You should normally select a source from the JS+Y (CC#01)...JS X controller group.

 This will operate irrespective of the module. The Combination and Sequencer mode, Perf Real-Time Parameters "A/B/C/D" (7-6) settings will be ignored.

**Setting examples**

Joystick operations in the +Y direction will control GE Parameter1. (Program mode)

Dynamic MIDI 1 <b>Source</b> (7-7b):	<b>JS+Y (CC#01)</b>
Dynamic MIDI 1 <b>Bottom</b> (7-7b):	<b>000</b>
Dynamic MIDI 1 <b>Top</b> (7-7b):	<b>127</b>
Dynamic MIDI 1 <b>Action</b> (7-7b):	<b>Continuous</b>
Dynamic MIDI 1 <b>Destination</b> (7-7b):	<b>RTParm Ctrl</b>
Dynamic MIDI 1 <b>Polarity</b> (7-7b):	<b>+</b>
GE RT Parameter 1 <b>Assign</b> (7-5b)	<b>Dyn1</b>

**Tempo [Momentary, Toggle, Continuous]**

Control the KARMA tempo.

*Note:* You will normally select the JS+Y (CC#01)...JS X controller group as the source.

 This will operate irrespective of the module. The Combination and Sequencer mode, Perf Real-Time Parameters "A/B/C/D" (7-6) settings will be ignored.

- When **Polarity** is +, you can use the controller to speed up the tempo. When the value of the controller selected as the source is at the value specified for "Bottom," the tempo will be at the regular specified setting. When the value of the controller selected as the source is at the value specified for "Top," the tempo will be double the regular tempo. (The tempo will not be faster than the maximum tempo of ♩=300 BPM.)
- When **Polarity** is -, you can use the controller to slow down the tempo. When the value of the controller selected as the source is at the value specified for "Bottom," the tempo will be at the regular specified setting. When the value of the controller selected as the source is at the value specified for "Top," the tempo will be half the regular tempo. (The tempo will not be slower than the minimum tempo of ♩=35 BPM.)

**Note/Env Latch [Momentary, Toggle]**

Control "Note Latch" of the KARMA module.

When you select Note/Env Latch as the **Destination** and turn "A/B/C/D" (7-6: Perf Real-Time Parameters) On (checked), you will be able to use the damper pedal etc. to control note latch independently of the "Note Latch" (7-4b) setting of each KARMA module, or the setting of the LATCH SWITCH.

*Note:* You will normally select the JS+Y (CC#01)...JS X controller group as the source.

*Note:* If you turn latch on using this setting, the operation of Envelope 1, 2, and 3 will also be affected. Regardless of the Envelope "Latch" (7-4b) settings for each KARMA module, you can use a damper pedal etc.

to turn latch on so that the currently-operating Envelope1, 2, or 3 will continue to be held even after you release the keyboard or the Pad 1-8.

**Examples of use**

**Setting 1** (Program mode)

**Note Latch** (7-4b): **On** (normally leave this **On** for a program)

Dynamic MIDI 1 **Source** (7-7b): **Damper (CC#64)**  
 Dynamic MIDI 1 **Bottom** (7-7b): **000**  
 Dynamic MIDI 1 **Top** (7-7b): **127**  
 Dynamic MIDI 1 **Action** (7-7b): **Momentary**  
 Dynamic MIDI 1 **Destination** (7-7b): **Note/Env Latch**  
 Dynamic MIDI 1 **Polarity** (7-7b): **+**

When the KARMA LATCH switch is on, latch will always be on.

When the KARMA LATCH switch is off, pressing the connected damper pedal will turn latch on, and releasing it will turn latch off.

**Setting 2** (Combination mode)

A **Note Latch** (7-4b): **On**  
 B **Note Latch** (7-4b): **Off**  
 Dynamic MIDI 1 **Source** (7-7b): **Damper(CC#64)**  
 Dynamic MIDI 1 **Bottom** (7-7b): **000**  
 Dynamic MIDI 1 **Top** (7-7b): **127**  
 Dynamic MIDI 1 **Action** (7-7b): **Momentary**  
 Dynamic MIDI 1 **Destination** (7-7b): **Note/Env Latch**  
 Dynamic MIDI 1 **A** (7-7b): **On (checked)**  
 Dynamic MIDI 1 **B** (7-7b): **On (checked)**  
 Dynamic MIDI 1 **Polarity** (7-7b): **+**

When the KARMA LATCH switch is on, latch will be on for KARMA Module A, and latch will be off for KARMA module B.

When the KARMA LATCH switch is off, pressing the connected damper pedal will turn latch on for both modules A and B, and releasing the pedal will turn latch off for both modules A and B.

**Auto Transpose On/Off** [Momentary]

Controls on/off of the auto transpose function.

*Note:* You will normally select the JS+Y (CC#01)...JS X controller group as the source.

**Auto Transpose Range** [Continuous]

Controls the amount of transposition for the auto transpose function.

When "AutoTranspose On/Off" is **on**, playing chord data for each KARMA module within the keyboard range specified as the "Auto Transpose Range" source will automatically transpose the current chord, rather than enter a new chord.

*Note:* Select the source from the Short Note...Black Note note group. The **Polarity** (7-7b) setting will be ignored. If you select a source from the JS+Y (CC0#1)...JSX controller group or the Velocity...Velocity Outside Zone velocity group, it will not be possible to control the transpose amount of the auto transpose function.

**Examples of use**

**Settings** (Program mode)

Dynamic MIDI 1 **Source** (7-7b): **KARMA Switch 1**  
 Dynamic MIDI 1 **Bottom** (7-7b): **000**  
 Dynamic MIDI 1 **Top** (7-7b): **127**  
 Dynamic MIDI 1 **Action** (7-7b): **Momentary**  
 Dynamic MIDI 1 **Destination** (7-7b): **AutoTranspose On/Off**  
 Dynamic MIDI 1 **Polarity** (7-7b): **+**  
 Dynamic MIDI 2 **Source** (7-7b): **Note**  
 Dynamic MIDI 2 **Bottom** (7-7b): **000 (C-1)**  
 Dynamic MIDI 2 **Top** (7-7b): **060 (C4)**

Dynamic MIDI 2 **Action** (7-7b): **C**  
 Dynamic MIDI 2 **Destination** (7-7b): **AutoTranspose Range**

Dynamic MIDI 2 **Polarity** (7-7b): **+**

- 1. Turn on KARMA, and play the keyboard. Play a Cmaj7 chord.**  
 KARMA will generate a phrase according to the selected GE and the settings of the KARMA module.
- 2. Turn on KARMA SWITCH 1.**  
 The auto transpose function will be turned **on**. The Cmaj7 chord will be remembered.
- 3. When you play a note number in the range specified by Bottom and Top (7-7b), the Cmaj7 chord will be transposed with that note as the root.**  
 If you play D3, KARMA will generate a phrase based on Dmaj7. If you play E3, the phrase will be based on Emaj7.
- 4. Turn off KARMA SWITCH 1. The auto transpose function will be turned off, and KARMA will resume normal operation.**

**Module Stop** [Momentary]

Controls KARMA module stop.

Operating the selected source controller when KARMA is operating will stop the playback of the KARMA Module. (KARMA will remain on.) When you apply a trigger (for example by playing the keyboard), the module will resume functioning.

**Melodic Repeat Stop** [Momentary]

Allows additional notes generated by the "Melodic Repeat" feature to be stopped. This is valid only when the GE selected by the KARMA module uses the "Melodic Repeat" function.

**Example**

Some GEs (but not all of them) utilize "Melodic Repeat" to generate additional repeated notes from the notes that are generated. The repeated notes created by "Melodic Repeat" will normally continue playing their specified number for repeats even when you turn off the KARMA ON/OFF switch.

If you want the repeated notes to stop immediately when you turn KARMA off, use the KARMA ON/OFF switch to control Repeat Stop.

**Settings** (Program mode)

Dynamic MIDI 1 **Source** (7-7b): **KARMA On/Off**

Dynamic MIDI 1 <b>Bottom</b> (7-7b):	000
Dynamic MIDI 1 <b>Top</b> (7-7b):	127
Dynamic MIDI 1 <b>Action</b> (7-7b):	<b>Momentary</b>
Dynamic MIDI 1 <b>Destination</b> (7-7b):	<b>Repeat Stop</b>
Dynamic MIDI 1 <b>Polarity</b> (7-7b):	-

**Module Stop & Repeat Stop [Momentary]**

Combines the effects of Module Stop and Melodic Repeat Stop (above), so that all note generation from the assigned module(s) will be immediately terminated.

*Note:* You can use a source from any of the three groups, but typically it will be the Controller Group.

**Module Pause [Momentary, Toggle]**

Operating the selected source controller when KARMA is operating will pause the playback of the KARMA Module.

When the KARMA module parameter "Run" (Combination/Sequencer 7-1c) is turned Off (unchecked), the KARMA module will continue operating internally without pausing. This means that when "Run" is turned On (checked), the phrase or pattern will not resume from where the phrase or pattern had stopped, but rather the phrase or pattern will continue playing from the moment at which the setting was turned On. In contrast, Dynamic MIDI Module Pause makes the phrase or pattern resume playing from where it was stopped.

**Example**

Move the joystick in the +Y direction to pause and then resume the phrase produced by the currently-operating KARMA module.

**Settings** (Program mode)

Dynamic MIDI 1 <b>Source</b> (7-7b):	<b>JS+Y (CC#01)</b>
Dynamic MIDI 1 <b>Bottom</b> (7-7b):	000
Dynamic MIDI 1 <b>Top</b> (7-7b):	127
Dynamic MIDI 1 <b>Action</b> (7-7b):	<b>Momentary</b>
Dynamic MIDI 2 <b>Destination</b> (7-7b):	<b>Module Pause</b>
Dynamic MIDI 2 <b>Polarity</b> (7-7b):	+

When you move the joystick all the way in the +Y direction, the phrase will pause. When you return the joystick to the center, the phrase will resume playing.

**Chord Scan [Continuous]**

Control the chord analysis that controls the phrase or pattern generated by the KARMA module.

Normally, each KARMA module detects chords by notes that are input in the key zone (Program 7-1a, Combination/Sequencer 7-1b) specified for each module. Instead of this key zone, you can control chord detection using the note range specified by the **Bottom** and **Top** (7-7b) of the source.

Chord analysis affects the operation of the following GE parameters. (For more information, see the "KARMA GE guide," beginning on page 1019.)

- Note Series Group: "Chord Shift"
- Note Series Group: "Note Type" Scalic or Scalic 2
- Note Series Group: "Filter Notes"
- CCs/Pitch Group: "Chord Shift"

- Repeat Group: "Chord Shift"
- Drum Group: "NTT (Note Table Transposition) On/Off"

⚠ For KARMA modules affected by the Chord Scan specified here, the key zone note input specified for each module will not be used for chord detection on that module.

*Note:* Select the Note, Note Inside Zone, or Note Outside Zone note group as the source. The **Polarity** (7-7b) setting will be ignored. Chord analysis cannot be controlled if you select a source from the JS+Y (CC#01)...JS X controller group, a note group other than the above, or the Velocity...Velocity Outside Zone Velocity group.

**Example**

Select a GE of "GE Type" 3: Real-Time (ⓂVNL), and use the keyboard to input the chord that will control the phrase or notes being played by Melodic Repeat.

**Settings** (Program mode)

Dynamic MIDI 1 <b>Source</b> (7-7b):	<b>Note Outside Zone</b>
Dynamic MIDI 1 <b>Action</b> (7-7b):	<b>Continuous</b>
Dynamic MIDI 1 <b>Destination</b> (7-7b):	<b>Chord Scan</b>
KeyZone <b>Btm</b> (7-1a):	<b>C4</b>
KeyZone <b>Top</b> (7-1a):	<b>C9</b>

Play the high range of the keyboard above C4 (specified as the key zone) to trigger phrases and notes produced by KARMA. At this time, play the lower range of the keyboard to control the chord of the phrase or notes in realtime. (Playing the lower range of the keyboard will not produce sound, but will only control the chord.) This allows you to play the lower range of the keyboard to vary the chord while "Melodic Repeat" is producing an extended phrase, letting you control the development of the phrase.

**Smart Scan [Continuous]**

As with Chord Scan, this controls the chord analysis that controls the phrase or pattern generated by the KARMA module.

Normally, each KARMA module will detect chords from notes that are input in the key zone specified for each module (Program 7-1a, Combination/Sequencer 7-1b). Instead of this key zone, you can use notes in the range specified by the source **Bottom** and **Top** (7-7b) to control chord detection.

Note input by key zone or chord detection by Chord Scan requires one or more notes, while Smart Scan requires three or more notes to be input in a given area. In general when you perform using both hands, the chord will change when you play three or more notes in either hand. For example if you press C4 for key zone note input or Chord Scan, the chord will be detected as C maj. In contrast, Smart Scan will not detect a chord when you press C4, but will (for example) detect C Maj when you simultaneously press C4/E4/G4.

In addition, Smart Scan takes into consideration the keyboard location and number of notes that are played, allowing more sophisticated and intuitive control of the timing of chord detection and the bass note handling.

 Note input in the key zone specified for each module will not be used for normal chord detection on KARMA modules for which Smart Scan is operating. If Smart Scan and Chord Scan are specified simultaneously, the Chord Scan note range will also be handled as the Smart Scan note range.

*Note:* Select a source from the Note, Note Inside Zone, or Note Outside Zone note group. The **Polarity** (7-7b) settings will be ignored. Chord analysis can not be controlled if you select the source from the JS+Y (CC#01)...JS X controller group, a note group other than listed above, or the Velocity...Velocity Outside Zone Velocity group.

**Example**

Play a chord in either the left hand or right hand to control the phrase or pattern generated by the KARMA module. In this example, we will use the right hand to play a solo phrase, and the left hand to play a bass riff etc. in realtime without changing the chord. This example assumes a GE is setup full-range over the entire keyboard, with Thru In Zone turned on.

**Settings** (Program mode)

Dynamic MIDI 1 <b>Source</b> (7-7b):	Note
Dynamic MIDI 1 <b>Bottom</b> (7-7b):	000
Dynamic MIDI 1 <b>Top</b> (7-7b):	127
Dynamic MIDI 1 <b>Action</b> (7-7b):	Continuous
Dynamic MIDI 1 <b>Destination</b> (7-7b):	Smart Scan

Using your left hand, play three or more notes to control the chord. If you wish to use your right hand to play a solo part in the high keyboard range, the chord will not change as long as you keep a certain distance from the left hand and play only two notes or less.

In the same way, use your right hand to play three or more notes in the upper range of the keyboard to control the chord. You can use your left hand to play a bass line in the lower range of the keyboard without changing the chord.

Chord detection will not occur while the KARMA module is receiving damper on. When you press the damper pedal, chord detection will be locked, and notes you add while the damper is on will not change the chord.

**Clock Advance** [Momentary, Toggle, Continuous]

This lets you use a controller such as the joystick or note-on/off operations to trigger the clock by which KARMA operates, thus using Manual Advance to advance the phrase or pattern.

Set the "Clock Advance Mode" (7-3b) of the KARMA module being controlled to Dyn, Auto+Dyn1, or Auto+Dyn2.

*Note:* If you select the source from the Short Note...Black Note note group or Velocity...Velocity Outside Zone Velocity group, set **Action** (7-7b) to C. (See "Action (Source Action)" on page 128.)

**Examples**

**Setting 1** (Program mode)

Control by joystick operations.

Dynamic MIDI 1 <b>Source</b> (7-7b):	JS+Y (CC#01)
Dynamic MIDI 1 <b>Bottom</b> (7-7b):	000

Dynamic MIDI 1 <b>Top</b> (7-7b):	127
Dynamic MIDI 1 <b>Action</b> (7-7b):	Momentary
Dynamic MIDI 1 <b>Destination</b> (7-7b):	Clock Advance
Dynamic MIDI 1 <b>Polarity</b> (7-7b):	+
Clock Advance <b>Mode</b> (7-3b):	Dyn

**Setting 2** (Program mode)

Use note-on/off played in the upper range of the keyboard to advance the phrase generated by playing chords in the lower range of the keyboard (specified by the key zone).

Dynamic MIDI 1 <b>Source</b> (7-7b):	Note Outside Zone
Dynamic MIDI 1 <b>Action</b> (7-7b):	Continuous
Dynamic MIDI 1 <b>Destination</b> (7-7b):	Clock Advance
Dynamic MIDI 1 <b>Polarity</b> (7-7b):	+
Clock Advance <b>Mode</b> (7-3b):	Dyn
KeyZone <b>Btm</b> (7-1a):	C-1
KeyZone <b>Top</b> (7-1a):	B3
KeyZone <b>Thru In Z</b> (7-1a):	Off (unchecked)
KeyZone <b>Thru Out Z</b> (7-1a):	Off (unchecked)

**Trigger Notes & Envs** [Momentary, Toggle, Continuous]

**Trigger Notes** [Momentary, Toggle, Continuous]

**Trigger Env 1** [Momentary, Toggle, Continuous]

**Trigger Env 2** [Momentary, Toggle, Continuous]

**Trigger Env 3** [Momentary, Toggle, Continuous]

Control triggering of GE phrases and/or Envelopes 1/2/3 of the KARMA module. With Trigger Notes & Envs, GE phrases and Envelopes 1/2/3 will all be triggered. Other settings allow these to be triggered individually.

 If you are using a GE that does not use envelopes, the envelope-related settings made here will be ignored. (☞VNL)

**Direct Index** [Continuous]

Direct index is a function that uses controllers or notes to specify which notes of the GE Phrase will be generated.

*Note:* Normally you will select a source from the JS+Y (CC#01)...JS X controller group or the Short Note...Black Note note group.

The GE uses note data from the keyboard to internally create a "Note Series" from which phrases and patterns are generated according to a variety of internal parameter settings. You can use a controller to "sweep" the Note Series directly, or directly index any note in it with the note-on/off operation assigned here.

**Direct Index & Mdl Stop** [Continuous]

Simultaneously with controlling **Direct Index** (described above), this also controls the Module Stop function. The currently-running KARMA module will stop when the first Direct Indexed note is generated.

*Note:* Normally you should select a source from the JS+Y (CC#01)...JS X controller group or the Short Note...Black Note note group.



Use this when you wish to stop the phrase or pattern played by the KARMA module and simultaneously switch to realtime note generation by Direct Index.

**Direct Index 1 Way [Continuous]**

The same as Direct Index (above), but only functions in one direction of the selected controller. In other words, if you were to assign a joystick to the normal Direct Index setting above, the notes would sweep as you move the joystick in one direction, and then sweep back again as you return the joystick in the other direction. With Direct Index 1 Way, the release does not cause any note generation in the return direction - it only indexes in one direction of movement. This is also quite useful with the Ribbon #16 setting, since unless "Ribbon Lock" is turned on, releasing the finger at one end of the ribbon will "snap back" to the center value, creating spurious notes on release (unless this setting is used).

The **Polarity** setting choose which direction it operates in. The following example shows the Dynamic MIDI Source set to "Ribbon #16". (Moving in the opposite direction from what is shown produces no action.)

**Polarity = +:**

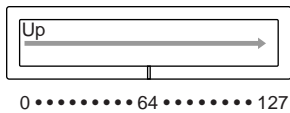

**Polarity = -:**

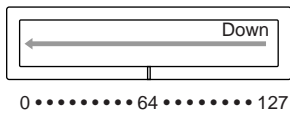

**Polarity = +/-:**

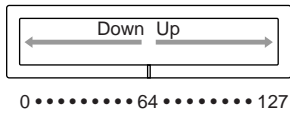

**Polarity = -/+:**

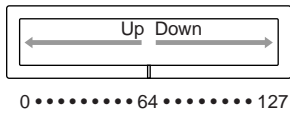

*Note:* Normally you should select a source from the JS+Y (CC#01)...JS X controller group.

**Dir.Idx 1 Way & Mdl Stop [Continuous]**

Simultaneously with controlling Direct Index 1 Way (described above), this also controls the Module Stop function. The currently-running KARMA module will stop when the first Direct Indexed note is generated.

*Note:* Normally you should select a source from the JS+Y (CC#01)...JS X controller group,

Use this when you wish to stop the phrase or pattern played by the KARMA module and simultaneously switch to realtime note generation by Direct Index.

**BufferLatch [Momentary, Toggle]**

When on, allows input notes to be added to the group of input notes that is causing the KARMA phrase to be generated, even if you release the notes while playing them.

*Note:* Normally you should select a source from the JS+Y (CC#01)...JS X controller group.

Normally, playing a single C4 note will input just C4 to the KARMA module, controlling the phrase or pattern. If you release the C4 and then play a single B4 note, just B4 will be input to the KARMA module. However, if you turned Buffer Latch on when you played the single C4 note, the KARMA module will maintain the C4 even when you release the keyboard, so that when you play a single B4 note, the B4 will be added. C4 and B4 will be input to the KARMA module, controlling the phrase or pattern.

**Example**

**Settings** (Program mode)

Dynamic MIDI 1 <b>Source</b> (7-7b):	<b>Damper(CC#64)</b>
Dynamic MIDI 1 <b>Bottom</b> (7-7b):	<b>000</b>
Dynamic MIDI 1 <b>Top</b> (7-7b):	<b>127</b>
Dynamic MIDI 1 <b>Action</b> (7-7b):	<b>Momentary</b>
Dynamic MIDI 1 <b>Destination</b> (7-7b):	<b>BufferLatch</b>
Dynamic MIDI 1 <b>Polarity</b> (7-7b):	<b>+</b>
Receive MIDI Filter <b>Damper (CC#64)</b> (7-2a):	<b>Off (unchecked)</b>

1. **With KARMA on, play the keyboard. Hold down the damper pedal, and play C4. The chord will be detected as Cmaj, and a phrase based on Cmaj will be played.**
2. **While continuing to hold down the damper pedal, play B4. The chord will be detected as Cmaj7. If you were not using Buffer Latch, the chord would be detected as Bmaj.**
3. **Notes will be added until you release the damper pedal and play the keyboard.**

Since Receive MIDI Filter "Damper (CC#64)" is turned **Off (unchecked)** in this example, the damper pedal will not produce the conventional damper effect when KARMA is **on**.

Use this when you want to add notes in this way to modify the phrase or pattern.

## MIDI transmission from KRONOS controllers

The following tables show the relation between the MIDI messages that are transmitted when the KRONOS's controllers are operated, and the AMS (alternate modulation source) or DMS (dynamic modulation source) that correspond to each MIDI message.

# indicates a fixed function, and \* indicates an assignable function.

When one of the KRONOS's controllers is operated, the corresponding or the assigned control change will be transmitted.

If you choose KARMA RTC Slider 1–8, KARMA RTC SW 1–8, or PAD 1–8, its MIDI control change message will be transmitted according to the settings in Global P2– Controller (2–1b).

The following sections describe operation in each mode.

MIDI transmission from KRONOS controllers Dynamic MIDI Destinations

MIDI Messages and physical controllers

CC#	MIDI messages	VJS	VJS-CC Control	Realtime Knob 5-8	KARMA					Pads 1-8	Foot Switch	Foot Pedal	Available for AMS	Available for Dmod
					On/Off	Latch	Scene	SW 1-8	Sliders 1-8					
	Note-off (velocity)												*(2)	
	Note-on (note number)												*	*
	Note-on (velocity)												*	*
	Program change													
	Channel after touch												*	*
	Poly after touch												*	*
	Pitch Bend												*	*
0	Bank select (MSB)	*	*	*	*	*	*	*	*	*				
1	Modulation 1	*	*	*	*	*	*	*	*	*	*	*	*	*
2	Modulation 2	*	*	*	*	*	*	*	*	*	*	*	*	*
3	-	*	*	*	*	*	*	*	*	*				
4	Foot controller	*	*	*	*	*	*	*	*	*		*	*	*
5	Portamento time	*	*	*	*	*	*	*	*	*		*		
6	Data entry (MSB)	*	*	*	*	*	*	*	*	*				
7	Volume	*	*	*	*	*	*	*	*	*		*		
8	Post Insert Effect panpot	*	*	*	*	*	*	*	*	*		*		
9	-	*	*	*	*	*	*	*	*	*				
10	Panpot	*	*	*	*	*	*	*	*	*		*		
11	Expression	*	*	*	*	*	*	*	*	*		*		
12	Effect control 1	*	*	*	*	*	*	*	*	*		*		*
13	Effect control 2	*	*	*	*	*	*	*	*	*		*		*
14	KARMA On/Off button	*	*	*		(*)	*	*	*	*		*(1)		
15	-	*	*	*	*	*	*	*	*	*				
16	Ribbon controller	*	*	*	*	*	*	*	*	*	*	*	*	*
17	Knob modulation 5	*	*	*	*	*	*	*	*	*			*	*
18	Controller (CC#18)	*	*	*	*	*	*	*	*	*	*	*	*	*
19	Knob modulation 6	*	*	*	*	*	*	*	*	*			*	*
20	Knob modulation 7	*	*	*	*	*	*	*	*	*			*	*
21	Knob modulation 8	*	*	*	*	*	*	*	*	*			*	*
22	KARMA Slider 1	*	*	*	*	*	*	*	(*) SL1	*	*(1)	*(1)		
23	KARMA Slider 2	*	*	*	*	*	*	*	(*) SL2	*	*(1)	*(1)		
24	KARMA Slider 3	*	*	*	*	*	*	*	(*) SL3	*	*(1)	*(1)		
25	KARMA Slider 4	*	*	*	*	*	*	*	(*) SL4	*	*(1)	*(1)		
26	KARMA Slider 5	*	*	*	*	*	*	*	(*) SL5	*	*(1)	*(1)		
27	KARMA Slider 6	*	*	*	*	*	*	*	(*) SL6	*	*(1)	*(1)		
28	KARMA Slider 7	*	*	*	*	*	*	*	(*) SL7	*	*(1)	*(1)		
29	KARMA Slider 8	*	*	*	*	*	*	*	(*) SL8	*	*(1)	*(1)		
30	KARMA SCENE 1-8 buttons	*	*	*	*	*	(*)	*	*	*	*(1)			
31	KARMA LATCH On/Off button	*	*	*	*	(*)	*	*	*	*	*(1)			
32	Bank select (LSB)	*	*	*	*	*	*	*	*	*				
33...	-	*	*	*	*	*	*	*	*	*				
37	-	*	*	*	*	*	*	*	*	*				
38	Data entry (LSB)	*	*	*	*	*	*	*	*	*				
39...	-	*	*	*	*	*	*	*	*	*				
63	-	*	*	*	*	*	*	*	*	*				
64	Damper	*	*	*	*	*	*	*	*	*			*	*
65	Portamento On/Off	*	*	*	*	*	*	*	*	*	*	*	*	*
66	Sostenuto	*	*	*	*	*	*	*	*	*	*	*	*	*
67	Soft pedal	*	*	*	*	*	*	*	*	*	*	*	*	*
68...	-	*	*	*	*	*	*	*	*	*				
69	Sustain level	*	*	*	*	*	*	*	*	*				
71	Filter resonance level	*	*	*	*	*	*	*	*	*	*	*		
72	Release time	*	*	*	*	*	*	*	*	*	*	*		
73	Attack time	*	*	*	*	*	*	*	*	*	*	*		
74	Filter cutoff frequency	*	*	*	*	*	*	*	*	*	*	*		
75	Decay time	*	*	*	*	*	*	*	*	*	*	*		
76	LFO1 speed	*	*	*	*	*	*	*	*	*	*	*		
77	LFO1 depth (pitch)	*	*	*	*	*	*	*	*	*	*	*		



# Appendices

CC#	MIDI messages	VJS	VJS-CC Control	Realtime Knob 5-8	KARMA					Pads 1-8	Foot Switch	Foot Pedal	Available for AMS	Available for Dmod
					On/Off	Latch	Scene	SW 1-8	Sliders 1-8					
78	LFO1 delay	*	*	*	*	*	*	*	*	*				
79	Filter EG intensity	*	*	*	*	*	*	*	*	*	*	*		
80	SW1 modulation On/Off	*	*	*	*	*	*	*	*	*			*	*
81	SW2 modulation On/Off	*	*	*	*	*	*	*	*	*			*	*
82	Foot switch On/Off	*	*	*	*	*	*	*	*	*	*		*	*
83	Controller (CC#83)	*	*	*	*	*	*	*	*	*			*	*
84	-	*	*	*	*	*	*	*	*	*				
85	Vector joystick modulation +X	*	*	*	*	*	*	*	*	*			*	*
86	Vector joystick modulation -X	*	*	*	*	*	*	*	*	*			*	*
87	Vector joystick modulation +Y	*	*	*	*	*	*	*	*	*			*	*
88	Vector joystick modulation -Y	*	*	*	*	*	*	*	*	*			*	*
89...	-	*	*	*	*	*	*	*	*	*				
90	-	*	*	*	*	*	*	*	*	*				
91	Effect depth 1 (send 2 level)	*	*	*	*	*	*	*	*	*		*		
92	Effect depth 2 (Insert Effect 1-12 On/Off)	*	*	*	*	*	*	*	*	*				
93	Effect depth 3 (send 1 level)	*	*	*	*	*	*	*	*	*		*		
94	Effect depth 4 (master effect 1, 2 On/Off)	*	*	*	*	*	*	*	*	*				
95	Effect depth 5 (total effect 1, 2 On/Off)	*	*	*	*	*	*	*	*	*				
96	Data increment	*	*	*	*	*	*	*	*	*				
97	Data decrement	*	*	*	*	*	*	*	*	*				
98	NRPN(LSB)	*	*	*	*	*	*	*	*	*				
99	NRPN(MSB)	*	*	*	*	*	*	*	*	*				
100	RPN(LSB)	*	*	*	*	*	*	*	*	*				
	0: Bend range	*	*	*	*	*	*	*	*	*				
	1: Fine tune	*	*	*	*	*	*	*	*	*				
	2: Coarse tune	*	*	*	*	*	*	*	*	*				
101	RPN(MSB) 0	*	*	*	*	*	*	*	*	*				
102	KARMA SW1	*	*	*	*	*	*	#SW1	*	*				*(1)
103	KARMA SW2	*	*	*	*	*	*	#SW2	*	*				*(1)
104	KARMA SW3	*	*	*	*	*	*	#SW3	*	*				*(1)
105	KARMA SW4	*	*	*	*	*	*	#SW4	*	*				*(1)
106	KARMA SW5	*	*	*	*	*	*	#SW5	*	*				*(1)
107	KARMA SW6	*	*	*	*	*	*	#SW6	*	*				*(1)
108	KARMA SW7	*	*	*	*	*	*	#SW7	*	*				*(1)
109	KARMA SW8	*	*	*	*	*	*	#SW8	*	*				*(1)
110	PAD1 trigger/velocity	*	*	*	*	*	*	*	*	[*]PAD1				
111	PAD2 trigger/velocity	*	*	*	*	*	*	*	*	[*]PAD2				
112	PAD3 trigger/velocity	*	*	*	*	*	*	*	*	[*]PAD3				
113	PAD4 trigger/velocity	*	*	*	*	*	*	*	*	[*]PAD4				
114	PAD5 trigger/velocity	*	*	*	*	*	*	*	*	[*]PAD5				
115	PAD6 trigger/velocity	*	*	*	*	*	*	*	*	[*]PAD6				
116	PAD7 trigger/velocity	*	*	*	*	*	*	*	*	[*]PAD7				
117	PAD8 trigger/velocity	*	*	*	*	*	*	*	*	[*]PAD8				
118	Vector joystick X	[*](X)	*	*	*	*	*	*	*	*				
119	Vector joystick Y	[*](Y)	*	*	*	*	*	*	*	*				
Universal exclusive														
	Master volume			*								*		
	Master balance													
	Master fine tune													
	Master coarse tune													

(1): When a KARMA controller is assigned to a CC# indicated by [\*] (Global P2- Controller)

#: Fixed \*: Assignable

(2): EP-1 only

[\*]: The vector joystick, KARMA realtime controls, and chord trigger controllers can be assigned to CC#00–119. CC#s indicated by [\*] will be assigned automatically when you execute the Global P2–Controller page menu command “Reset Controller MIDI Assign” with the CC Default setting.

The CC Default settings are the CC#s recommended as the CC# for each of these controllers. Normally you should use these settings when assigning CC#s.

### Fixed assignments

The following physical controls have fixed assignments to MIDI CCs:

Joystick +Y	Modulation 1 (CC#1)
Joystick -Y	Modulation 2 (CC#2)
Joystick X	Pitch Bend
Value Slider	CC#18
Realtime Knob 1	Filter cutoff frequency (CC#74)
Realtime Knob 2	Filter resonance (CC#71)
Realtime Knob 3	Filter EG intensity (CC#79)
Realtime Knob 4	Release time (CC#72)
SW1	SW1 modulation On/Off (CC#80)
SW2	SW2 modulation On/Off (CC#81)
Ribbon Controller	Ribbon controller (CC#16)
Damper pedal	Damper (CC#64)

### Program mode

When one of the KRONOS’s controllers is operated, a control change message will be transmitted on the global MIDI channel (**MIDI Channel** Global 1–1a).

- ⚡ If the REALTIME KNOBS 1–8 or the assignable pedal has been set to **Master Volume**, the universal system exclusive message Master Volume will be transmitted.

### Combination mode

When one of the KRONOS’s controllers is operated, a control change message will be transmitted on the global MIDI channel (**MIDI Channel** Global 1–1a).

Simultaneously, the message will also be transmitted on the MIDI channel (**MIDI Channel** Combination 2–1a) of any timbre whose **Status** (Combination 0–1b, 2–1a) is EXT or EX2.

When one of the KRONOS’s controllers is operated, its effect will apply to any timbre whose **Status** is INT and whose **MIDI Channel** setting is either Gch or the same as the global MIDI channel.

- ⚡ In the case of Master Volume, the universal exclusive message Master Volume will be transmitted only on the global MIDI channel.
- ⚡ You can make settings for MIDI Filter (Combination P3) to enable or disable control changes and controllers for each timbre. When checked, the above operations will be enabled.

Effect dynamic modulation can be controlled when the **Ch** (Channel) setting for IFX1–12, MFX1, 2, or TFX 1, 2 is either set to Gch or to the same channel as the global MIDI channel. (In the case of All Routed, control is possible on the MIDI channel of any routed timbre.)

KARMA modules A, B, C, and D can be controlled if the Input Channel and Output Channel (Combination 7–1c) settings specified for each module are Gch or match the global channel.

### Sequencer mode

When one of the KRONOS’s controllers is operated, its effect will apply to the MIDI track 1–16 that is selected by **Track Select** (Sequencer 0–1a).

If the **Status** (Sequencer 2–1a) of the track selected by **Track Select** is EXT, EX2, or BTH, a control change message will be transmitted on the MIDI channel specified by **MIDI Channel** (Sequencer 2–1a).

If the **Status** is INT or BTH, operating one of the KRONOS’s controllers will affect only that MIDI track. Simultaneously, the same effect will also apply to any MIDI track with the same **MIDI Channel** setting.

- ⚡ In the case of Master Volume, the universal exclusive message Master Volume will be transmitted.
- ⚡ You can make settings for MIDI Filter (Sequencer P3) to enable or disable control changes and controllers for each track. When checked, the operations effective for a **Status** of INT or BTH will be enabled. Tracks whose **Status** is EXT, EX2, or BTH will transmit control changes regardless of this setting.

Effect dynamic modulation can be controlled when the **Ch** (Sequencer 8–7a, 9–2a, 9–3, 9–4) setting for IFX1–12, MFX1, 2, or TFX1, 2 matches the MIDI channel of the track selected by **Track Select**. (In the case of All Routed, control is possible on the MIDI channel of all routed tracks.)

If one of the KRONOS’s controllers is operated during realtime recording, the corresponding or assigned control change will be recorded.

KARMA modules A, B, C, and D can be controlled if the Input Channel and Output Channel (Sequencer 7–1c) settings specified for each module are Tch or match the MIDI channel of the MIDI track selected by Track Select.

### Sampling mode

When one of the KRONOS’s controllers is operated, a control change message will be transmitted on the global MIDI channel (**MIDI Channel** Global 1–1a).

- ⚡ In the case of Master Volume, the universal exclusive message Master Volume will be transmitted.
- ⚡ It is not possible to make AMS settings in Sampling mode.

## KRONOS and MIDI CCs

### Responses to standard MIDI controllers

The following table shows the relationships between MIDI CCs, physical controls on the KRONOS, and synthesis and effects parameters.

CC#	Name	Range	Notes
0	Bank select (MSB)	0...127	Bank Select message MSB *1
1	Modulation 1	0...127	Joystick +Y (forwards, away from the player)
2	Modulation 2	0...127	Joystick -Y (backwards, towards the player)
3	-	-	-
4	Foot Controller	0...127	AMS/Dmod source Foot Pedal.; may be assigned to the Assignable Pedal
5	Portamento time	0...127	Portamento time
6	Data entry (MSB)	0...127	MSB of RPN and NRPN data *2
7	Volume	0...127	Main volume *3
8	Post Insert Effect pan	0...127	Pan after the Insert Effect (Post-IFX Pan)
9	-	-	-
10	Panpot	0...127	Pan
11	Expression	0...127	Scales main volume *3
12	Effect Control 1	0...127	AMS/Dmod source FX Control1
13	Effect Control 2	0...127	AMS/Dmod source FX Control2
14	KARMA ON/OFF	0...63(Off), 64...127(On)	Default CC assignment for KARMA KARMA ON/OFF switch *7
15	-	-	-
16	Ribbon Controller	0...127	Ribbon controller touch position
17	Knob modulation 5	0...127	AMS/Dmod source Knob Mod.5; may be assigned to REALTIME knobs 5...8
18	Controller (CC#18)	0...127	AMS/Dmod source *8 *6
19	Knob Modulation 6	0...127	AMS/Dmod source Knob Mod.6; may be assigned to REALTIME knobs 5...8
20	Knob Modulation 7	0...127	AMS/Dmod source Knob Mod.7; may be assigned to REALTIME knobs 5...8
21	Knob Modulation 8	0...127	AMS/Dmod source Knob Mod.8; may be assigned to REALTIME knobs 5...8
22	KARMA Slider 1	0...127	Default CC assignment for KARMA realtime control slider 1 *7
23	KARMA Slider 2	0...127	Default CC assignment for KARMA realtime control slider 2 *7
24	KARMA Slider 3	0...127	Default CC assignment for KARMA realtime control slider 3 *7
25	KARMA Slider 4	0...127	Default CC assignment for KARMA realtime control slider 4 *7
26	KARMA Slider 5	0...127	Default CC assignment for KARMA realtime control slider 5 *7
27	KARMA Slider 6	0...127	Default CC assignment for KARMA realtime control slider 6 *7
28	KARMA Slider 7	0...127	Default CC assignment for KARMA realtime control slider 7 *7
29	KARMA Slider 8	0...127	Default CC assignment for KARMA realtime control slider 8 *7
30	KARMA SCENE 1-8 switches	0...7(Scene1...8), 8...127(invalid)	Default CC assignment for KARMA SCENE switches 1...8 *7
31	KARMA LATCH	0...63(Off), 64...127(On)	Default CC assignment for KARMA LATCH switch *7
32	Bank select (LSB)	0...127	Bank Select message LSB *1
33...37	-	-	-
38	Data entry (LSB)	0...127	LSB of RPN or NRPN data *2

CC#	Name	Range	Notes	
39...63	–	–	–	
64	Damper	0...127	Damper (sustain pedal)	
65	Portamento On/Off	0...63(Off), 64...127(On)	Turns portamento (glide) on/off	
66	Sostenuto	0...63(Off), 64...127(On)	Sostenuto (holds only the notes sounding at the time that the footswitch is turned on)	
67	Soft	0...127	Soft pedal (reduces effective velocity)	
68...69	–	–	–	
70	Sustain level	0...127	Scales Sustain levels of the filter and amp EGs	*4
71	Filter resonance level	0...127	Scales filter resonance amount	*4
72	Release time	0...127	Scales Release times of the filter and amp EGs	*4
73	Attack time	0...127	Scales Attack times of the filter and amp EGs	*4
74	Filter cutoff frequency	0...127	Scales filter cutoff frequency (usually controls brightness)	*4
75	Decay time	0...127	Scales Decay and Slope times of the filter and amp EGs	*4
76	LFO1 speed	0...127	Scales LFO1 speed	*4
77	LFO1 depth	0...127	Scales amount of pitch modulation by LFO1	*4
78	LFO1 delay	0...127	Scales LFO1 delay	*4
79	Filter EG intensity	0...127	Scales amount of cutoff modulation by filter EG	*4
80	SW1 modulation	0...63(Off), 64...127(On)	AMS/Dmod source SW1 Mod.; may be assigned to physical SW1	
81	SW2 modulation	0...63(Off), 64...127(On)	AMS/Dmod source SW2 Mod.; may be assigned to physical SW2	
82	Foot switch	0...63(Off), 64...127(On)	AMS/Dmod source Foot Switch; may be assigned to the Assignable Foot Switch	
83	Controller (CC#83)	0...127	AMS/Dmod source	
84	–	–	–	
85	Vector joystick +X	0...127	Vector Joystick position on the X axis (VJS +X Mod)	
86	Vector joystick –X	0...127	Inverse of Vector Joystick position on the X axis (VJS –X Mod)	
87	Vector joystick +Y	0...127	Vector Joystick position on the Y axis (VJS +Y Mod)	
88	Vector joystick –Y	0...127	Inverse of Vector Joystick position on the Y axis (VJS –Y Mod)	
89...90	–	–	–	
91	Effect depth 1	0...127	Scales Send 2 level	
92	Effect depth 2	0...63(Off), 64...127(On)	Simultaneous on/off control for Insert Effects 1...12	*5
93	Effect depth 3	0...127	Scales Send 1 level	
94	Effect depth 4	0...63(Off), 64...127(On)	Simultaneous on/off control for Master Effects 1&2	*5
95	Effect depth 5	0...63(Off), 64...127(On)	Simultaneous on/off control for Total Effects 1&2	*5
96	Data increment	0		
97	Data decrement	0		
98	NRPN(LSB)	–	LSB of NRPN	
99	NRPN(MSB)	–	MSB of NRPN	
100	RPN(LSB)	0	Selects Pitch Bend Range for RPN editing	*2
		1	Selects Fine Tune for RPN editing	*2
		2	Selects Coarse Tune for RPN editing	*2
101	RPN(MSB)	0	MSB of RPN	
102	KARMA SW1	0...63(Off), 64...127(On)	Default CC assignment for KARMA realtime control SW1	*7
103	KARMA SW2	0...63(Off), 64...127(On)	Default CC assignment for KARMA realtime control SW2	*7
104	KARMA SW3	0...63(Off), 64...127(On)	Default CC assignment for KARMA realtime control SW3	*7
105	KARMA SW4	0...63(Off), 64...127(On)	Default CC assignment for KARMA realtime control SW4	*7
106	KARMA SW5	0...63(Off), 64...127(On)	Default CC assignment for KARMA realtime control SW5	*7

CC#	Name	Range	Notes	
107	KARMA SW6	0...63(Off), 64...127(On)	Default CC assignment for KARMA realtime control SW6	*7
108	KARMA SW7	0...63(Off), 64...127(On)	Default CC assignment for KARMA realtime control SW7	*7
109	KARMA SW8	0...63(Off), 64...127(On)	Default CC assignment for KARMA realtime control SW8	*7
110	PAD 1	0...127	Default CC assignment for PAD 1	*7
111	PAD 2	0...127	Default CC assignment for PAD 2	*7
112	PAD 3	0...127	Default CC assignment for PAD 3	*7
113	PAD 4	0...127	Default CC assignment for PAD 4	*7
114	PAD 5	0...127	Default CC assignment for PAD 5	*7
115	PAD 6	0...127	Default CC assignment for PAD 6	*7
116	PAD 7	0...127	Default CC assignment for PAD 7	*7
117	PAD 8	0...127	Default CC assignment for PAD 8	*7
118	Vector joystick X	0...127	Default CC assignment for Vector Joystick X-axis	*8
119	Vector joystick Y	0...127	Default CC assignment for Vector Joystick Y-axis	*8

**\*1 Bank Select**

In the KRONOS sequencer, bank select messages are normally specified as part of program change events. In some cases, however, this may be insufficient when changing banks on an external device. In such cases, you can use CC#00 and CC#32 to specify the banks.

For information on the relation between bank select numbers and the banks of your external device, refer to the owner’s manual for your external device.

**\*2 RPN (Registered Parameter Number)**

Pitch bend range, fine tune, and coarse tune can be controlled using Registered Parameter Control (RPC) messages. As with standard CCs, these apply individually to each MIDI channel.

RPCs work differently from standard CCs. First, you send a Registered Parameter Number (RPN) message to select the parameter that you wish to edit. This message includes two CCs: first CC#100 with a value of 1, 2, or 3 (to select the parameter) and then CC#101 with a value of 0 (to complete the message).

Next, you set the value for the selected parameter using CC#06. In the case of RPN 1 (Fine Tune), you can also use CC#38 for extra-fine control.

The data entry values for each parameter and the corresponding settings are as follows.

*RPN CC#100=0 (Pitch Bend Range)*

CC#06	Bend range, Semitones
00	0
01	+1
...	...
12	+12

*RPN CC#100=1 (Fine Tune)*

CC#06	CC#38	Tuning, 1 cent steps
32	00	-50
...	...	...
48	00	-25
...	...	...
64	00	0
64	127	~+1.5
...	...	...
96	00	+50

*RPN CC#100=2 (Coarse Tune)*

CC#06	Tuning, semitones
40	-24
...	...
52	-12
...	...
64	0
...	...
88	+24

For example, if in Sequencer mode you wish to set a MIDI track on channel 1 to a transpose (coarse tuning) value of -12, you would first transmit [B0, 64, 02] (64H=CC#100) and [B0, 65, 00] (65H=CC#101) to the KRONOS to select the RPN coarse tune. Then you would set this to -12 by transmitting [B0, 06, 34] (06H=CC#6), 34H=52 (corresponds to -12), and [B0, 26, 00] (26H=CC#38, 00H=0).

**\*3 Volume and Expression**

The volume of the KRONOS is determined by multiplying Volume (CC#07) with Expression (CC#11). In Sequencer mode when you stop the song playback and return the location to the beginning of the track, the Volume will be set to the starting value, and the Expression will be set to the maximum value (127).

**\*4 CCs 70...79**

A value of 64 will correspond to the value specified by the program parameter. 0 is the minimum, and 127 is the maximum. Changing from 63-1 or from 65-126 will adjust the effect from the program parameter setting toward the minimum value or maximum value.

For details about the specific parameters controlled by these CCs, please see "Parameters controlled by MIDI CCs #70-79" on page 1123.

**\*5 Effect Depths 2, 4, and 5**

These CCs are recognized only on the global MIDI channel.

**\*6 VALUE slider and CC#18**

Most of the time, the VALUE slider is used only for entering values. You can also use the VALUE slider to as a modulation source, but only when the following are true:

- You're on the Program mode P0-Main page, and the big Program name is selected, or
- You're on the Combination mode P0- Prog Select/Mixer page, and the big Combination name is selected.
- You're on the Set List P0-Play page.

In these cases only, the VALUE slider sends MIDI CC#18, and can be used as a modulation source.

**\*7 CC assignments for KARMA and Pads**

As shipped from the factory, for simplicity, all KARMA and Pad CC assignments are set to Off. However, the KRONOS has a set of recommended CC assignments, as shown in the table above. These assignments can be loaded in a single step by using the **Reset Controller MIDI Assign** menu command on the Global P2-Controller page. For more information, see "Reset Controller MIDI Assign" on page 812.

**\*8 Vector Joystick and MIDI CCs**

By default, the Vector Joystick X-axis and Y-axis are assigned to CCs 118 and 119, as shown in the table above. These can be changed if desired.

The Global MIDI **Vector MIDI Out** parameter also affects MIDI transmission from the Vector Joystick and Vector EG. For more information, see "Vector and MIDI" on page 47 and "Vector MIDI Out" on page 773.

---

## Parameters controlled by MIDI CCs #70-79

MIDI CCs#70-79 have fixed assignments to control basic Program parameters, for quick and simple control of timbre. You can use these CCs from MIDI, or from the front-panel controls.

Realtime Knobs 1-4 are always assigned to four of these CCs, as shown below:

Knob 1	CC#74-Filter Cutoff
Knob 2	CC#71-Filter Resonance
Knob 3	CC#79-EG Intensity
Knob 4	CC#72-EG Release Time

Knobs 5-8 can be assigned to various functions, including any of the CCs#70-79.

The specific parameters controlled by the CCs will vary depending on the synth algorithm being used, as shown in the tables below:

- "HD-1" on page 1124
- "AL-1 and STR-1" on page 1124
- "CX-3" on page 1125
- "MS-20EX" on page 1125
- "PolysixEX" on page 1125
- "MOD-7" on page 1125
- "SGX-1" on page 1126
- "EP-1" on page 1126

These CCs modulate the underlying parameters, instead of editing them directly. In most cases, a value of 64 (knob pointing straight up) is equal to the programmed parameter value; turning the CC down to

0 reduces the parameter to its minimum value, and turning the CC up to 127 increases the parameter to its maximum value. In other cases, such as some EG parameters, the action of the CC may be more complex.

In Program mode, these modulated values can be stored back into the parameters, if desired. Just use the **Write Program** menu command, and the modulation will be converted into the underlying parameter values, over-writing the previous settings. After doing this, the CCs will be reset to 64.

In Sampling mode, these CCs will modulate their parameters just as in Program mode. You can use the **Convert MS to Program** menu command to save the current state as a Program, in which case the modulation will be converted into the underlying parameter values.

In Combination and Sequencer modes, the CCs will modulate the parameters for all Timbres or Tracks on a given MIDI channel. However, edits made in this way cannot be saved back into a Program.

**HD-1**

CC#	Internal parameters controlled by the CC
70 (Sustain level)	Filter EG 1/2 Sustain (see page 78) Amp EG 1/2 Sustain (see page 87)
71 (Filter resonance)	Filter A/B, 1/2 Resonance (see page 71)
72 (Release time)	Filter EG 1/2 Release (see page 78) Amp EG 1/2 Release (see page 88)
73 (Attack time)	EG Times: Filter EG 1/2 Attack (see page 78) Amp EG 1/2 Attack (see page 88) Amp EG 1/2 Time Modulation: Attack (see page 89) EG Levels: Amp EG 1/2 Level Start (see page 87) Amp EG 1/2 Level Attack (see page 87) Amp EG 1/2 Level Modulation: Start (see page 89)
74 (Filter cutoff frequency)	Filter A/B, 1/2 Frequency (see page 70)
75 (Decay time)	Filter EG 1/2 Decay (see page 78) Filter EG 1/2 Slope (see page 78) Amp EG 1/2 Decay (see page 88) Amp EG 1/2 Slope (see page 88)
76 (LFO1 speed)	LFO 1 Frequency (see page 93)
77 (LFO1 Pitch intensity)	Pitch LFO1 Intensity (see page 64)
78 (LFO1 delay)	LFO 1 Delay (see page 94)
79 (Filter EG intensity)	Filter EG 1/2 Intensity to A (see page 74) Filter EG 1/2 Intensity to B (see page 75)

**AL-1 and STR-1**

70 (Sustain level)	EG 1 (Filter) Sustain (see page 212) Amp EG Sustain (see page 208)
71 (Filter resonance)	Filter A&B Resonance (see page 199)
72 (Release time)	EG 1 (Filter) Release (see page 212) Amp EG Release (see page 209)
73 (Attack time)	EG Times: EG 1 (Filter) Attack (see page 212) Amp EG Attack (see page 209) Amp EG Time Modulation: Attack (see page 209) EG Levels: Amp EG Start (see page 208) Amp EG Attack (see page 208) Amp EG Level Modulation: Start (see page 209)
74 (Filter cutoff frequency)	Filter A&B Frequency (see page 199)
75 (Decay time)	EG 1 (Filter) Decay (see page 212) EG 1 (Filter) Slope (see page 212) Amp EG Decay (see page 209) Amp EG Slope (see page 209)
76 (LFO1 speed)	LFO1 Frequency (see page 218)
77 (LFO1 Pitch intensity)	Pitch LFO Intensity (see page 193)
78 (LFO1 delay)	LFO1 Delay (see page 219)
79 (Filter EG intensity)	Filter A&B EG Intensity (see page 202)



### CX-3

70...79	No supported parameters
---------	-------------------------

### MS-20EX

70 (Sustain level)	EG2 SUSTAIN LEVEL (see page 305)
71 (Filter resonance)	LPF PEAK (see page 301)
72 (Release time)	EG2 RELEASE TIME (see page 305)
73 (Attack time)	EG2 ATTACK TIME (see page 305)
74 (Filter cutoff frequency)	LPF FREQUENCY (see page 301)
75 (Decay time)	EG2 DECAY TIME (see page 305)
76 (LFO1 speed)	LFO1 Frequency (see page 218)
77 (LFO1 Pitch intensity)	FREQUENCY MODULATION MG/T.EXT (see page 300)
78 (LFO1 delay)	LFO1 Delay (see page 219)
79 (Filter EG intensity)	LPF EG2/EXT (see page 301)

### PolysixEX

70 (Sustain level)	PolysixEX EG SUSTAIN (see page 329)
71 (Filter resonance)	VCF RESONANCE (see page 328)
72 (Release time)	PolysixEX EG RELEASE (see page 329)
73 (Attack time)	PolysixEX EG ATTACK (see page 329)
74 (Filter cutoff frequency)	VCF CUTOFF (see page 328)
75 (Decay time)	PolysixEX EG DECAY (see page 329)
76 (LFO1 speed)	LFO1 Frequency (see page 218)
77 (LFO1 Pitch intensity)	VIBRATO INT (see page 327)
78 (LFO1 delay)	LFO1 Delay (see page 219)
79 (Filter EG intensity)	VCF EG INTENSITY (see page 328)

### MOD-7

70 (Sustain level)	EG 8 (Filter) Sustain (see page 381) Amp EG Sustain (see page 208)
71 (Filter resonance)	Filter A&B Resonance (see page 199)
72 (Release time)	EG 8 (Filter) Release (see page 381) Amp EG Release (see page 209)
73 (Attack time)	EG Times: EG 8 (Filter) Attack (see page 381) Amp EG Attack (see page 209) Amp EG Time Modulation: Attack (see page 209) EG Levels: Amp EG Start (see page 208) Amp EG Attack (see page 208) Amp EG Level Modulation: Start (see page 209)
74 (Filter cutoff frequency)	Filter A&B Frequency (see page 199)
75 (Decay time)	EG 8 (Filter) Decay (see page 381) EG 8 (Filter) Slope (see page 212) Amp EG Decay (see page 209) Amp EG Slope (see page 209)
76 (LFO1 speed)	LFO1 Frequency (see page 218)
77 (LFO1 Pitch intensity)	EG 8 (Filter) Sustain (see page 381) Amp EG Sustain (see page 208)
78 (LFO1 delay)	Filter A&B Resonance (see page 199)
79 (Filter EG intensity)	Filter A&B EG Intensity (see page 202)

**SGX-1**

72 (Release time)	Release Time (see page 391)
74 (Filter cutoff frequency)	Lid Position (see page 391)

**EP-1**

70...79	No supported parameters
---------	-------------------------

## MIDI applications

### About MIDI

MIDI stands for Musical Instrument Digital Interface, and is a world-wide standard for exchanging various types of musical data between electronic musical instruments and computers. When MIDI cables are

used to connect two or more MIDI devices, performance data can be exchanged between the devices, even if they were made by different manufacturers.

### Connecting MIDI devices & computers

#### Controlling an external MIDI tone generator from the KRONOS

When you wish to use the KRONOS's keyboard, controllers, and sequencer etc. to play an external MIDI tone generator, use a MIDI cable to connect the KRONOS's MIDI OUT connector to the MIDI IN connector of the external MIDI tone generator.

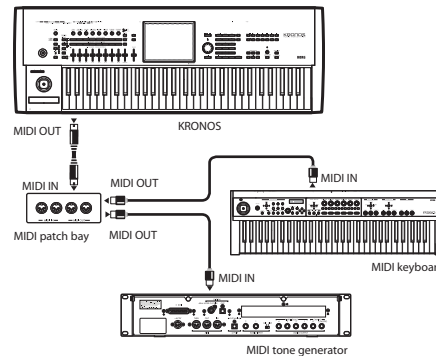

#### Controlling the KRONOS's tone generator from an external MIDI device

When you wish to play or control the KRONOS's tone generator from an external MIDI keyboard or sequencer etc., use a MIDI cable to connect the MIDI OUT connector of the external MIDI device to the MIDI IN connector of the KRONOS.

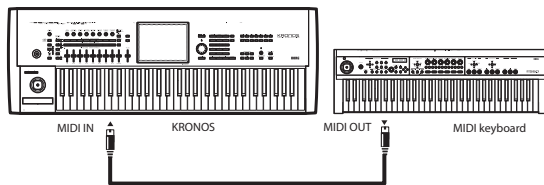

#### Controlling two or more external MIDI tone generators from the KRONOS

You can use the MIDI THRU jack to simultaneously control multiple MIDI devices. (This type of connection should be used to connect no more than three devices. If you wish to connect a larger number of MIDI devices, we recommend that you use a MIDI patch bay as shown in the second diagram below.)

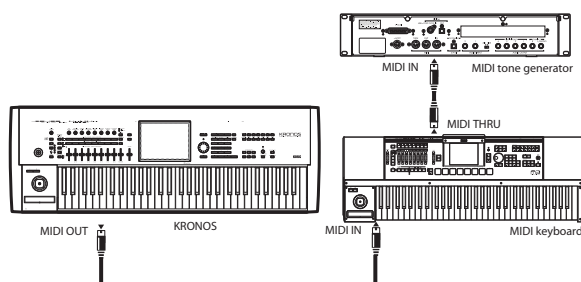

You can also use a MIDI patch bay to control multiple MIDI devices.

#### The "Convert Position" setting

On the KRONOS, **Key Transpose**, **Velocity Curve** and **After Touch Curve** (Global 0–1a) allow you to transpose the pitch, adjust the velocity sensitivity, and adjust the after touch sensitivity.

The effect that these settings will have on the internal sequencer and on the MIDI data that is transmitted and received will depend on "Convert Position" (Global 1–1a) setting.

- If you want to control an external MIDI tone generator from the KRONOS, set "Convert Position" to PreMIDI. The various settings listed above will be reflected in the MIDI data that is transmitted. These settings will also be reflected in the data that is recorded on the internal sequencer.

Incoming MIDI data will be handled with settings equivalent to **Key Transpose 0**, **Velocity Curve 4**, and **After Touch Curve 3**.

- When controlling the KRONOS's tone generator from an external MIDI device, select PostMIDI. The above-listed settings will affect the MIDI data that is received. These settings will also affect the data that is played back from the internal sequencer.

Outgoing MIDI data will be handled with settings equivalent to **Key Transpose 0**, **Velocity Curve 4**, and **After Touch Curve 3**.

#### Connecting an external MIDI sequencer or computer

You can play the KRONOS's keyboard and record your performance on an external MIDI sequencer/computer (connected via a MIDI interface), and then play back the recorded performance to sound the KRONOS's tone generator (i.e., using the KRONOS as an input

keyboard and MIDI tone generator). To do this, connect the MIDI OUT and MIDI IN connectors of the KRONOS and your external MIDI sequencer/ computer to each other.

As an alternative to MIDI, you can connect the KRONOS directly to the computer via USB, using the KRONOS' USB B port.

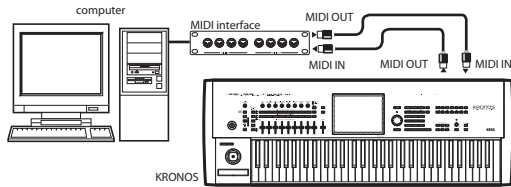

## Local Control On settings

When connections are made as shown above, turn on the Echo Back function of the external MIDI sequencer or computer (so that data received at MIDI IN will be re-transmitted from MIDI OUT), and turn off the KRONOS's Local Control setting (so that the KRONOS's keyboard and tone generator will be internally disconnected).

When you play the keyboard of the KRONOS, the musical data will be transmitted to the external MIDI sequencer or computer, and then echoed back to play the KRONOS's tone generator. In other words, by turning Local Control OFF, you can prevent notes from being sounded in duplicate, as would otherwise occur if a note were sounded by the KRONOS's own keyboard and again by the data that was echoed-back.

To turn off Local Control, press the "Local Control On" (Global P1: 1-1a) check box to uncheck it.

When using the KRONOS by itself, leave Local Control turned on. (If this is off when the KRONOS is used by itself, playing the keyboard will not produce sound.)

When using KARMA, the Global **KARMA External MIDI Routing** settings and the local control on/off setting will determine how the function is controlled, as follows. For more information, see "KARMA External Routing" on page 774.

Here are the settings to use if you want an external MIDI sequencer or computer to record only the notes that trigger KARMA, and control KARMA using the notes that are echoed-back during recording or playback.

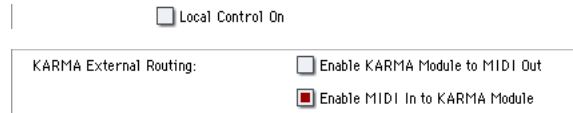

When KARMA is turned on, playing the KRONOS' keyboard will not trigger KARMA; the notes you play on the keyboard will only be transmitted. KARMA will operate only on the notes that are echoed-back and received at MIDI IN. This prevents KARMA from being applied in duplicate, and ensures that it will operate correctly.

Note: You can also make these settings by using the page menu command "Setup KARMA External MIDI Routing"= Send the output of KARMA to external device/sequencer. For more information, see "Set Up KARMA External MIDI Routing" on page 811.

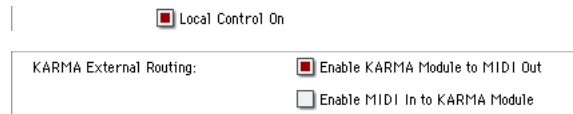

Here are the settings to use if you want the note data generated by KARMA to be transmitted via MIDI and recorded on your external sequencer or computer.

Note: You can also make these settings by using the page menu command "Setup KARMA External MIDI Routing"= Trigger KARMA generation from external device/sequencer.

## USB MIDI controllers

### Overview

The KRONOS supports direct connection of USB-MIDI class compliant devices to the rear-panel USB A ports. Multiple USB MIDI controllers can be connected simultaneously, if desired.

The KRONOS provides no user interface for USB controllers. Any settings stored in the controller, including controller assignments, MIDI channel, and so on will apply in the communication between the controller and the KRONOS. If the controller supports different internal setups (such as Scenes on Korg devices), you can switch between them to change the controller's functionality.

If the controller is set to a different MIDI channel than the KRONOS's Global MIDI Channel, you can use it to play a different sound than the local keyboard in Combinations or Songs, as controlled by the Timbre or Track MIDI settings. You can also play the Drum Track Program in Program mode, while still playing the

main Program from the keyboard, by setting the pads to send on the Drum Track's MIDI channel (see "Prog MIDI Ch" on page 776).

Bus-powered devices are supported, subject to the current limits defined by the USB specification. For more information, see "USB Power" on page 23 of the Operation Guide.

### Limitations of USB MIDI device support

MIDI clock is not supported from USB MIDI devices. System Exclusive messages from USB MIDI devices are limited to 16-bytes. Additionally, certain messages are not supported, such as mode changes and dump requests.

### USB pad controller support

You can play the chord pads using Korg USB MIDI controllers equipped with drum pads, including:

- nanoPAD and nanoPAD2

- microKONTROL
- padKONTROL
- KONTROL49

When a supported controller is connected, the KRONOS will automatically determine the MIDI assignments of the controller's pads 1-8, and map them directly to the KRONOS pads. If settings on the controller are changed (such as when selecting a different Scene on a nanoPAD2), the mapping will be updated automatically.

This mapping uses a special internal mechanism, independent of the Pads 1-8 parameters on the Global 2-1: Controllers page (see "Pads 1-8" on page 782). Only the Korg USB controllers listed above are supported. If you change the controller's assignments for the pads (for instance, by selecting a different Scene on the controller), the KRONOS will update its mapping automatically.

From the perspective of MIDI, these USB-connected pads act exactly the same as if you were touching the on-screen pads. Playing the USB pads will transmit controller or note data as determined by the Global Controllers Pads 1-8 parameters (see above) and the Global 1-1: MIDI page Pads MIDI Out parameter (see "Pads MIDI Out" on page 774).

Messages from the standard MIDI input and from the USB B port (for MIDI to and from a computer) are not affected by the automatic pad mapping.

### Limitations of USB pad support

The nanoPAD and nanoPAD2 both support multiple note assignments per pad. Only the first such event will be mapped to the KRONOS pads; the remainder act as normal MIDI in events.

The automatic mapping supports only pads assigned to either notes or CCs. If a pad is configured to send a different type of MIDI message (for instance, the nanoPAD2 lets pads send Program Change messages), these messages cannot be mapped to KRONOS pads, and will instead be interpreted as normal MIDI events.

The automatic pad-mapping works by requesting setup information from the Korg USB controller, and then internally mapping the MIDI events assigned to pads 1-8 so that they control the KRONOS pads. For instance, if the USB device's pad 2 sends MIDI note A4 on channel 03, the KRONOS detects this and configures itself appropriately.

Note that the KRONOS can't tell which physical control caused the USB device to send a given message. For instance, continuing with the above, if the USB device's pad 2 and pad 9 both send MIDI note A4 on channel 03, both USB pads will trigger the KRONOS's pad 2. Similarly, if the USB device has a keyboard as well as pads, playing A4 will also play the KRONOS's pad 2.

One final exception: if the USB device supports multiple ports, such as the KONTROL49, the KRONOS can distinguish between the different ports. For instance, if the USB device's pad 2 and pad 9 both send MIDI note A4 on channel 03, but pad 2 sends on port A and pad 9 sends on port B, then pad 9 will not trigger the KRONOS's pad 2.

## Messages transmitted and received by the KRONOS

In the text below, [...] indicates hexadecimal notation.

### MIDI channels

MIDI messages can be exchanged when the transmitting and receiving devices are set to the same MIDI channel. MIDI uses sixteen channels, numbered 1-16. The way in which channels are handled will differ depending on the mode.

#### Program mode and Sampling mode

- Transmission/reception is performed on the global MIDI channel.

The global MIDI channel is the basic channel that the KRONOS uses for MIDI transmission/reception, and is set by **MIDI Channel** (Global 1-1a).

#### Combination mode

- The global MIDI channel is used to transmit/receive messages for selecting a combination and turning effects on/off, and to transmit/receive exclusive data.
- Each timbre will transmit/receive MIDI data on the **MIDI Channel** (Combination 2-1a) that is specified for that timbre.

- The **Ch** MIDI channel specified for each effect (Combination 8-7a, 9-2a, 9-3, 9-4, 9-5) is used to control dynamic modulation of the insert/master/total effects, the pan following the insert effect, and send 1 and 2.
- When you operate the keyboard or controllers of the KRONOS, messages will be transmitted on the global MIDI channel, and will also be transmitted on the MIDI channel of any timbre whose **Status** (Combination 2-1a) is set to EXT or EX2.
- Channel messages will be received if they match the MIDI channel of a timbre whose **Status** is set to INT (Combination 2-1a).

#### Sequencer mode

- The global MIDI channel is used to transmit/receive exclusive data and for messages that switch effects on/off.
- MIDI data transmission/reception for each MIDI track will occur on the MIDI channel specified for each MIDI track by **MIDI Channel** (Sequencer 2-1a).
- The MIDI channel specified for each effect by the **Ch** parameter (Sequencer 8-7a, 9-2a, 9-3, 9-4, 9-5) is used to control dynamic modulation of the

insert/master/total effects, the pan following the insert effect, and send 1 and 2.

- When you operate the keyboard or controllers of the KRONOS, messages will be transmitted on the MIDI channel selected by **Track Select** (Sequencer 0–1a). However, messages will be transmitted only if the selected MIDI track has a **Status** of BTH, EXT, or EX2. For more information, see “Track Select” on page 515.

 If you’ve selected Audio Track 1–16 in the Track Select field, this will apply to the MIDI track you selected most recently. The Track Information field will indicate “KBD.”

- When the sequencer is played back, musical data of MIDI tracks whose **Status** is BTH, EXT, or EX2 will be transmitted on the specified MIDI channels.
- MIDI tracks whose **Status** is INT or BTH will receive channel messages of the matching MIDI channel. For more information, see “Status” on page 564, and “MIDI Channel” on page 565.

### Note on/off

**Note-on** [9n, kk, vv]

**Note-off** [8n, kk, vv]

(n: channel, kk: note number, vv: velocity)

When you play a note on the KRONOS’s keyboard, it will transmit note-on/off messages.

While KARMA is operating, the note-on/off data generated by KARMA will be transmitted. (“Local Control On settings” on page 1128)

However, most instruments do not receive or transmit note-off velocity, and neither does the KRONOS.

## Program Change/Bank Select

### Changing the program/bank

**Program change** [Cn, pp]

(n: channel, pp: program number that allows 128 sounds to be selected)

- Programs 000–127 in banks I–A...F and U–A...GG correspond to program changes [Cn, 00]–[Cn, 7F].
- Programs 001–128 in banks G, g(1), g(2), g(3), g(4), g(5), g(6), g(7), g(8), g(9), and g(d) correspond to program changes [Cn, 00]–[Cn, 7F].

**Bank select MSB (CC#0)** [Bn, 00, mm]

**Bank select LSB (CC#32)** [Bn, 20, bb]

(n: channel, mm: bank number upper byte, bb: bank number lower byte)

- The internal banks that correspond to each bank select number will depend on the “Bank Map” setting (Global 0–1d). Korg is the default setting. For more information, see “Bank Map” on page 755.

Simply receiving a Bank Select message will not cause the program or bank to change. The program or bank will actually change when a Program Change message is received.

### Program mode

- In Program P0: Play, program change and bank select messages are transmitted and received on the

global MIDI channel. These messages are not received in P1–P9.

### Combination and Sequencer modes

- Program change and bank select messages can be received on the MIDI channel specified for each timbre/MIDI track to select programs on that timbre/track.
- When you select a combination, program change and bank select messages will be transmitted by timbres whose **Status** is EXT or EX2.

In Sequencer mode, program change or bank select messages will be transmitted by tracks whose **Status** is BTH, EXT, or EX2 when you select the “Program Select” parameter (0–1b), when you select a song, or when you return to the beginning of a measure. (“Program select”  p.516)

- In Combination and Sequencer modes, transmission/reception can be switched on/off for each timbre/track. See “Enable Program Change” on page 462, and “Enable Program Change” on page 576.

### Set List mode

- Program Change messages on the Global Channel select the Slot, and Bank Select messages on the Global Channel select the Set List.

When a Slot is selected via MIDI, the display updates if necessary to show the appropriate group of 16 buttons.

- Selecting a Slot sends Program Change and Bank Select messages, as above.

When selected, Combinations and Songs can transmit other Program Change and Bank Select messages on other channels, as they do in Combination and Sequencer modes.

- The Global P0 **Bank Map** (Korg, GM(2)) parameter does not affect the reception or transmission of Set List Program and Bank Select messages.

### Selecting combinations

You can use program change and bank select messages to select combinations in the same way that you select programs.

- Combinations 000–127 in banks I–A...G and U–A...G correspond to program changes [Cn, 00]–[Cn, 7F].
- Similarly as for program banks, the internal banks that correspond to each bank select number will depend on the “Bank Map” setting (Global 0–1d). For more information, see “Bank Map” on page 755.
- In Combination P0: Play, program change and bank select messages are transmitted/received on the global MIDI channel. They are not received in P1–P9.

*Note:* All program changes can be turned off in MIDI Filter (Global 1–1c)

As needed, you can independently turn all program changes on/off, specify whether or not incoming messages will be able to change combinations, and turn reception/transmission of bank select messages on/off.

- If “Enable Combination Change” (Global 1–1c) is unchecked, the combination will not change even if a program change on the global MIDI channel is received in Combination P0: Play. In this case, the program of the timbre that matches the MIDI channel of the received message will change.
- If “Enable Bank Change” (Global 1–1c) is unchecked, bank select messages will not be transmitted or received.

---

## After touch

### Channel aftertouch [Dn, vv]

(n: channel, vv: value)

When you apply pressure to the keyboard after playing a note, an after touch effect will be applied, and Channel After Touch messages will be transmitted. When these messages are received, an after touch effect will be applied.

- After touch for the entire instrument can be turned on/off in “Enable After Touch” (Global 1–1c).
- In Combination and Sequencer modes, after touch can be switched on/off independently for each timbre/track (“Enable After Touch” Combination 3–1a, Sequencer 3–1a).

### Polyphonic aftertouch [An, kk, vv]

(n: channel, kk: note number, vv: value)

There is another type of after touch called Polyphonic Key Pressure, which allows after touch to be applied independently for individual keys. This message can be used as an alternate modulation source, but cannot be transmitted by the KRONOS’s keyboard. In order to use this message, it will have to be received from an external device, or recorded on your sequencer.

The after touch mentioned in this manual refers to Channel After Touch.

---

## Pitch bend

### Pitch bend change [En, bb, mm]

(n: channel, bb: lower byte of the value, mm: upper byte of the value, together expressing a value of 16,384 steps where 8,192 [bb, mm = 00H, 40H] is the center value)

When the KRONOS’s joystick is moved in the X axis (left/right), a pitch bend effect will be applied, and pitch bender messages will also be transmitted. When these messages are received, a pitch bend effect will be applied.

The range of pitch change that is produced by pitch bend messages can also be adjusted via MIDI. (See “Changing the pitch bend range” on page 1136.)

---

## Control change

[Bn, cc, vv]

Transmitted and received as (n: channel, cc: control change no., vv: value)

For more information, see “Dynamic MIDI Sources & Destinations” on page 1109, “MIDI transmission from KRONOS controllers” on page 1116, and “KRONOS and MIDI CCs” on page 1120

- Control changes can be turned on/off as a whole in “Enable Control Change” (Global 1–1c).
- In Combination and Sequencer modes, the P3: MIDI Filter settings allow transmission/reception of control changes to be individually turned on/off for each timbre/track. For the assignable controllers (SW1, SW2, REALTIME KNOBS 1–8, Foot Pedal/Switch), MIDI filter settings will apply to the control change number to which each controller is assigned. “Other Control Change” applies to control changes that are not covered by the items of the other check boxes.

*Note:* You can select MIDI CC#00–CC#119 for “REALTIME KNOBS 5–8” and for “vector joystick CC control.”

Although you can select MIDI CC#00–CC#119 for the KARMA controllers and the vector joystick, you will normally use the default settings that are assigned when you execute the page menu command “Reset Controller MIDI Assign” with Default Setting, and leave KARMA Controllers turned Off, vector joystick “VJS X” at CC#118, and “VJS Y” at CC#119.

If you assign a CC# to KARMA controllers, use the same CC#s as when “Reset Controller MIDI Assign” is executed with the CC Default setting.

---

## Selecting program/combination banks

### Bank select (CC#00, CC#32)

Technically, Bank Select is a controller. In practice, however, it is a component of Program Change. For more information, see “Program Change/Bank Select” on page 1130)

---

## Using the joystick to apply modulation

### Modulation 1 depth (CC#01) [Bn, 01, vv]

When you move the KRONOS’s joystick in the +Y direction (Vertical upward), Modulation 1 Depth messages will be transmitted. When these messages are received, the same effect will be applied as when the KRONOS’s joystick is operated. Normally this will apply a vibrato effect (pitch LFO).

- In Combination and Sequencer modes, transmission/reception can be switched on/off for each timbre/track (“Enable JS+Y” Combination/Sequencer 3–1a).

### Modulation 2 depth (CC#02) [Bn, 02, vv]

When you move the KRONOS’s joystick in the –Y direction (Vertical downward), Modulation 2 Depth messages will be transmitted. When these messages



are received, the same effect will be applied as when the KRONOS's joystick is operated. Normally this will apply a wah effect (filter LFO).

- In Combination and Sequencer modes, transmission/reception can be switched on/off for each timbre/track ("Enable JS-Y" Combination/Sequencer 3–1a).

Other manufacturers use this message for other purposes (e.g., breath controller, etc.)

---

## Controlling portamento

### Portamento time (CC#05) [Bn, 05, vv]

If you assign the above CC# to a REALTIME KNOBS 5–8 or as the vector joystick CC control function, rotating that knob will transmit Portamento Time messages, and will modify the speed at which the portamento pitch changes. When this message is received, the result will be the same as when the controller is operated.

### Portamento switch (CC#65) [Bn, 41, vv]

When the above CC# is assigned to SW1, SW2 or the ASSIGNABLE SWITCH, operating that switch will transmit vv=127 [7F] for ON or vv=0 [00] for OFF, and the portamento effect will be switched on/off. When this message is received, the result will be the same as when the controller is operated. (vv of 63 [3F] or less will be OFF, and 64 [40] or greater will be ON.) (See "SW1/2 Assignments" on page 1104)

- In Combination and Sequencer modes, transmission/reception of this message can be turned on/off independently for each timbre/track ("Enable Portamento SW" Combination/Sequencer 3–1a).
- In Sequencer mode, portamento time/switch messages will be transmitted by each track whose **Status** is BTH, EXT, or EX2 when you set "Portamento" (2–2a), re-select a song or SMF, or return to the beginning of a measure. For more information, see "Portamento" on page 566.

---

## Controlling volume

### Volume (CC#07) [Bn, 07, vv]

When the above CC# is assigned to the ASSIGNABLE PEDAL or as the REALTIME KNOBS 5–8 or as the vector joystick CC control function, operating that controller will transmit Volume messages, and the volume will change. When this message is received, the result will be the same as when the controller is operated.

### Expression (CC#11) [Bn, 0B, vv]

When the above CC# is assigned to the ASSIGNABLE PEDAL or as the REALTIME KNOBS 5–8 or as the vector joystick CC control function, operating that controller will transmit Expression messages, and the volume will change. When this message is received, the result will be the same as when the controller is operated.

The volume of the KRONOS is determined by multiplying the value of the Volume message with the value of the Expression message.

If adjusting the Volume message does not increase the volume as you expect, or if there is no sound, transmit MIDI messages from an external device to reset the value of the Expression message (set vv to 127).

*Note:* In Sequencer mode, this will be reset when the "Location" of the song is moved to 001:01.000.

- In Combination mode, Volume messages will be transmitted by each timbre whose **Status** is EXT or EX2 when you re-select the combination.
- When you change the **Volume** setting (Sequencer 0–1b) in Sequencer mode, or when you re-select the song or return to the beginning of the song in Sequencer mode, volume messages will be transmitted by each track whose **Status** is BTH, EXT, or EX2.

*Note:* If you've used the CONTROL ASSIGN TIMBRE/TRACK switch to select 1–8/9–16, operating the sliders will transmit volume data to control the volume.

*Note:* Regardless of the **Status** settings, re-selecting a song, or returning to the beginning will reset the internal Volume value to the value specified by each track (the starting settings), and will reset the Expression value to the maximum.

*Note:* This message can be used to control the volume of each MIDI track. Normally, you will include a Volume message in the MIDI track setting data (the settings at the beginning of the track) to set the initial volume, and use Expression to create changes in dynamics as the song progresses.

By using the universal exclusive Master Volume message, you can adjust the overall volume without changing the volume balance between timbres or tracks. ("About system exclusive messages" p.1137)

---

## Controlling pan (stereo position)

### Pan (CC#10) [Bn, 0A, vv]

(vv: value, where 00 is far left, 64 is center, and 127 is far right)

When the above CC# is assigned to the ASSIGNABLE PEDAL or as the REALTIME KNOBS 5–8 or as the vector joystick CC control function, operating that controller will transmit Pan messages, and the panning will change. When this message is received, the result will be the same as when the controller is operated.

- When you set the **Pan** (Sequencer 0–1b) in Sequencer mode, or when you re-select the song or return to the beginning of the measure in Sequencer mode, Panpot messages (except for RND) will be transmitted by each track whose **Status** is BTH, EXT, or EX2. For more information, see "Pan" on page 517.

*Note:* If you've used the CONTROL ASSIGN TIMBRE/TRACK switch to select 1–8/9–16, operating the knobs will transmit panpot data to control the panning.

**Post insert effect pan (CC#08) [Bn, 08, vv]**

(vv: value, where 00 is far left, 64 is center, and 127 is far right)

When the above CC# is assigned to the ASSIGNABLE PEDAL or as the REALTIME KNOBS 5–8 or as the vector joystick CC control function, operating that controller will transmit Post Insert Effect Panpot messages, and the panning of the sound following the insert effect will change. When this message is received, the result will be the same as when the controller is operated.

- In Program mode and Sampling mode, this message is transmitted/received on the global MIDI channel. In Combination, and Sequencer modes, this message is transmitted/received on the MIDI channel specified for each insert effect.
- When you set “Pan (CC#8)” (Sequencer 8–5a) in Sequencer mode, or when you re-select the song or return to the beginning of the measure in Sequencer mode, Post Insert Effect Panpot messages will be transmitted by each track whose **Status** is BTH, EXT, or EX2. For more information, see “8–5a: IFX” on page 615.

**Controlling effects****Effect Control 1 (CC#12) [Bn, 0C, vv]****Effect Control 2 (CC#13) [Bn, 0D, vv]**

These CCs are used for effects dynamic modulation (Dmod), and can be programmed to control various effects parameters. Note that other CCs can also be used as Dmod sources, if desired.

Effect control 1 and 2 can be assigned to the ASSIGNABLE PEDAL, REALTIME KNOBS 5–8, or the Vector Joystick.

**Effect 1 depth (Send 2) (CC#91) [Bn, 5B, vv]****Effect 3 depth (Send 1) (CC#93) [Bn, 5D, vv]**

These CCs control the per-Osc/Timbre/Track and post-IFX send levels for Master Effects 1 and 2. In Combination and Sequencer modes, the channel used to control post-IFX send levels is the channel of the Timbres/Tracks routed through the IFX, instead of the effect’s Control Channel.

These CCs can be assigned to the ASSIGNABLE PEDAL, REALTIME KNOBS 5–8, or the Vector Joystick.

- In Combination and Sequencer modes, the actual send level of the timbre/track is determined by multiplying this value with the Program’s per-Oscillator Send 1/2 settings. For more information, see “OSC1 Send1 (to MFX1)” on page 136.
- In Sequencer mode, when you adjust **Send 1 (MFX1)** or **Send 2 (MFX2)**, or when you re-select a song or return to the beginning of the measure, Send 1/2 will be transmitted by each track whose **Status** is BTH, EXT, or EX2.

**Effect 2 depth (IFX1–12 on/off) (CC#92) [Bn, 5C, vv]****Effect 4 depth (MFX1, 2 on/off) (CC#94) [Bn, 5E, vv]****Effect 5 depth (TFX1, 2 on/off) (CC#95) [Bn, 5F, vv]**

Separately from the effect on/off settings in each mode, the **Effect Global SW** allows you to turn off insert effects IFX1–12 and master effects MFX1, 2 and total effect TFX1, 2 (see “0–1b: Effect Global SW” on page 755).

If you check **IFX1–12 Off**, **MFX1&2 Off** or **TFX1&2 Off**, the corresponding message will be transmitted with vv=0 [00]. If you uncheck these settings, the corresponding message will be transmitted with vv=127 [7F]. If you check these settings, the corresponding effect(s) will be turned off as a group. If you uncheck these settings, the on/off settings of each mode will be used. The same applies to reception. (vv of 00 is off, and 01 or greater is the original setting.) These messages are transmitted and received on the global MIDI channel.

*Note:* These messages are defined simply for use in adjusting the effect levels, and may not have the same function on another instrument connected to the KRONOS.

**Using various controllers**

Here we will explain typical ways to use the various controllers. You can choose from MIDI CC#00–CC#119 for “REALTIME KNOBS 5...8” and “vector joystick CC control.”

**Foot controller (CC#04) [Bn, 04, vv]**

If the above CC# is assigned as the ASSIGNABLE PEDAL function, this message will be transmitted when the controller is operated.

- In Combination and Sequencer modes, you can use the MIDI Filters to enable and disable transmission/reception of this message for each timbre/track. For more information, see “Enable Foot Pedal” on page 465.

**Ribbon controller (CC#16) [Bn, 10, vv]**

This message will be transmitted when the KRONOS’s ribbon controller is operated.

- In Combination and Sequencer modes, transmission/reception of this message can be turned on/off independently for each timbre/track (“Enable Ribbon” Combination/Sequencer 3–1a).

**Controller (CC#18) [Bn, 12, vv]**

This message will be transmitted when the KRONOS’s VALUE slider is operated.

This is valid in “Program Select” (Program P0: 0–1a) and “Combination Select” (Combination P0: 0–1a) when the program or combination number/name is selected (highlighted).

**Knob modulation 5, 6, 7, 8 (CC#17, 19, 20, 21) [Bn, 11, vv], [Bn, 13, vv], [Bn, 14, vv], [Bn, 15, vv]**

If the above CC# are assigned to the REALTIME KNOBS 5–8, these messages will be transmitted when the knobs are operated.

- In Combination and Sequencer modes, transmission/reception of this message can be turned on/off independently for each timbre/track (“Enable Realtime Controls Knob 5, 6, 7, 8” Combination/Sequencer 3–2a).

**Vector joystick modulation +X, -X, +Y, -Y [Bn, 55, vv], [Bn, 56, vv], [Bn, 57, vv], [Bn, 58, vv]**

If you assign the above CC#s as the vector joystick CC control functions, these messages will be transmitted when you operate the KRONOS’ controllers.

- 🔊 They will be transmitted if Global “MIDI Vector MIDI Out” is set to Vector CC Control.

**Controller (CC#83) [Bn, 53, vv]**

If you assign the above CC# to a REALTIME KNOBS 5–8 or as the vector joystick CC control function, this message will be transmitted when you operate the corresponding controller of the KRONOS.

**Damper pedal (CC#64) [Bn, 40, vv]**

This message is transmitted when you operate a damper pedal (Korg DS-1H etc.) connected to the DAMPER jack, and the damper effect will be turned on/off. If the DS-1H is used, a half-damper effect can be applied.

- In Combination and Sequencer modes, transmission/reception of this message can be turned on/off independently for each timbre/track (“Enable Damper” Combination/Sequencer 3–1a).

**SW1 modulation (CC#80) [Bn, 50, vv]**

**SW2 modulation (CC#81) [Bn, 51, vv]**

If the above CC# are assigned as the function of SW1 or SW2, operating the switch will transmit this message with vv=127 [7F] for ON, and vv=00 [00] for OFF.

- In Combination and Sequencer modes, transmission/reception of these messages can be turned on/off independently for each timbre/track (“Enable SW1,” “Enable SW2” Combination/Sequencer 3–3a)

**Foot switch (CC#82) [Bn, 52, vv]**

If the above CC# is assigned as the function of the ASSIGNABLE SWITCH, operating the switch will transmit this message with vv=127 [7F] for ON, and vv=00 [00] for OFF.

- In Combination and Sequencer modes, transmission/reception of this message can be turned on/off independently for each timbre/track (“Enable Foot Switch” Combination/Sequencer 3–3a).

**Sostenuto (CC#66) [Bn, 42, vv]**

If the above CC# is assigned as the function of the ASSIGNABLE SWITCH, operating the switch will transmit this message with vv=127 [7F] for ON, and vv=00 [00] for OFF, and the sostenuto effect will be turned on/off. When this message is received, the

result will be the same as when the controller is operated (OFF for vv=63 [3F] or below, and ON for vv=64 [40] or above).

**Soft pedal (CC#67) [Bn, 43, vv]**

If the above CC# is assigned as the function of the ASSIGNABLE SWITCH, operating the switch will transmit, and the soft pedal effect will be turned on. When this message is received, the result will be the same as when the controller is operated.

When “Foot controller (CC#04)”–“Soft pedal (CC#67)” are operated on the KRONOS, the specified alternate modulation or dynamic modulation etc. will be controlled. When these messages are received, the result will be the same as if the controller had been operated. For “SW1 modulation (CC#80)”–“Soft pedal (CC#67),” vv of 63 [3F] or less will be OFF, and 64 [3F] or greater will be ON.

---

**Controlling Program tone & envelope shapes**

CC#70–79 control specific parameters of a program. For details on the program parameters that correspond to each control change, and how the KRONOS will respond in each mode when these are received, refer to “KRONOS and MIDI CCs” on page 1120.

**Filter cutoff (CC#74) [Bn, 4A, vv]**

**Resonance level (CC#71) [Bn, 47, vv]**

**Filter EG intensity (CC#79) [Bn, 4E, vv]**

**Release time (CC#72) [Bn, 48, vv]**

These messages are transmitted when you operate the KRONOS’s REALTIME KNOBS 1–4. (They can also be set as KNOB 5–8 functions.)

**Sustain level (CC#70) [Bn, 46, vv]**

**Attack time (CC#73) [Bn, 49, vv]**

**Decay time (CC#75) [Bn, 4B, vv]**

**LFO 1 speed (CC#76) [Bn, 4C, vv]**

**LFO 1 depth (pitch) (CC#77) [Bn, 4D, vv]**

**LFO 1 delay (CC#78) [Bn, 4E, vv]**

These messages are transmitted when assign the above CC# to the REALTIME KNOBS 5–8 or as the vector joystick CC control function.

When you operate these, the corresponding program parameters will be controlled, and the sound and envelope will change. When these messages are received, the result will be the same as when the controller is operated. (When the message has a value vv=64 [40], the setting will have the value that was set by the program parameter.)

- In Combination and Sequencer modes, transmission/reception can be turned on/off independently for each timbre/track (“Enable Realtime Controls Knob 1...8” Combination/Sequencer 3–2a).

*Note:* In Program mode, the corresponding program parameters will be temporarily edited by these messages. You can Write the program to save the modified state (except for certain parameters). The Write operation can also be performed by a MIDI System Exclusive Program Write Request message, in addition to the usual method of using the KRONOS’s switches. When you write the data, the values of the corresponding program parameters will be rewritten.

*Note:* The results of receiving these messages will depend on the instrument. The operation may be different when a device other than the KRONOS is connected.

---

## Vector control

If you assign the following CC#s to the X-axis and Y-axis of the vector joystick, the specified CC# will be transmitted when you operate the KRONOS, and the KRONOS itself will be controlled simultaneously. When this message is received, the result will be the same as if you operated the KRONOS itself.

You can use this to record vector joystick operations on the internal sequencer or an external MIDI sequencer, or to control the vector joystick from an external MIDI device.

The CC# settings for the vector joystick are made in the Global P2- Controller page. Although you can select any MIDI control change CC#00-CC#119 for the vector joystick, you will normally use the default settings that are assigned when you execute the page menu command "Reset Controller MIDI Assign" with Default Setting. For more information, see "Reset Controller MIDI Assign" on page 812.

 These messages are transmitted and received if Global "MIDI Vector MIDI Out" is set to Vector Joystick. If Global "MIDI Vector MIDI Out" is set to Vector CC Control, the CC# specified for Vector CC Control in each program, combination, or song will be transmitted. Normally you will use the Vector Joystick setting.

The operations described below are for these default settings.

Vector joystick X (CC#118) [Bn, 76, vv]  
Vector joystick Y (CC#119) [Bn, 77, vv]

When you move the KRONOS' vector joystick in the X direction, vector joystick X will be transmitted (vv: 00:left...7F:right). When you move it in the Y direction, vector joystick Y will be transmitted (vv: 00:toward yourself...7F:away). The same result will occur when these messages are received.

---

## KARMA function control

If you assign the following CC#s to the KARMA CONTROLS sliders and switches, the specified CC# will be transmitted when you operate the KRONOS, and the KRONOS itself will be controlled simultaneously. When these messages are received, the result will be the same as if you operated the KRONOS itself.

The CC# settings for each knob and switch are made in the Global P2- Controller page. Normally you will leave these Off. However, you can use these settings if you need to assign MIDI control change messages to these controllers, such as when you want to record the operations of the KARMA CONTROLS sliders and switches on the internal sequencer or an external MIDI sequencer, or to control KARMA from an external MIDI device.

Although you can select any MIDI control change CC#00-CC#119 for each slider and switch, you will normally use the default settings that are assigned when you execute the page menu command "Reset Controller MIDI Assign" with CC Default. For more information, see "Reset Controller MIDI Assign" on page 812.

The operations described below are for these CC Default settings. The messages will be transmitted when you operate the corresponding controller of the KRONOS. When these messages are received, the result will be the same as if you operated the controller on the KRONOS itself.

### KARMA ON/OFF (CC#14) [Bn, 0E, vv]

This corresponds to the KARMA ON/OFF switch. It transmits vv=127 [F7] when turned on, or vv=127 [7F] when turned off.

KARMA Slider1 (CC#22) [Bn, 16, vv]  
KARMA Slider2 (CC#23) [Bn, 17, vv]  
KARMA Slider3 (CC#24) [Bn, 18, vv]  
KARMA Slider4 (CC#25) [Bn, 19, vv]  
KARMA Slider5 (CC#26) [Bn, 1A, vv]  
KARMA Slider6 (CC#27) [Bn, 1B, vv]  
KARMA Slider7 (CC#28) [Bn, 1C, vv]  
KARMA Slider8 (CC#29) [Bn, 1D, vv]

These correspond to KARMA CONTROLS sliders 1-8.

KARMA SCENE (CC#30) [Bn,m 1E, vv]

This corresponds to the KARMA SCENE switches. (vv" value; 00: Scene 1, 01: Scene 2, 02: Scene 3, 03: Scene 4, 04: Scene 5, 05: Scene 6, 06: Scene 7, 07: Scene 8, 08...7F: invalid)

KARMA LATCH (CC#31) [Bn, 1F, vv]

This corresponds to the KARMA LATCH switch. It transmits vv=127 [F7] when turned on, or vv=127 [7F] when turned off.

KARMA SW1 (CC#102) [Bn, 66, vv]  
KARMA SW2 (CC#103) [Bn, 67, vv]  
KARMA SW3 (CC#104) [Bn, 68, vv]  
KARMA SW4 (CC#105) [Bn, 69, vv]  
KARMA SW5 (CC#106) [Bn, 6A, vv]  
KARMA SW6 (CC#107) [Bn, 6B, vv]  
KARMA SW7 (CC#108) [Bn, 6C, vv]  
KARMA SW8 (CC#109) [Bn, 6D, vv]

This corresponds to the KARMA SWITCH 1-8. It transmits vv=127 [F7] when turned on, or vv=127 [7F] when turned off.

---

## Pads 1-8 control

If you assign the following CC#s to pads 1-8, the specified CC# will be transmitted when you operate the KRONOS, and the KRONOS itself will be controlled simultaneously. When these messages are received, the result will be the same as if you operated the KRONOS itself.

The CC# settings for the pads are made in the Global P2- Controller page. Normally you will leave these Off. However, you can edit these settings if you need to assign MIDI control change messages to the pads, such as when you want to record pad operations on the internal sequencer or an external MIDI sequencer, or to control the pads from an external MIDI device.

These messages are transmitted and received if the Global P1– MIDI page parameter “Pads MIDI Out” is set to Pad CC/Note. If “Pads MIDI Out” is set to Chord Notes, the “Pad Chords” setting made in each program, combination, song, or in Sampling mode will be transmitted.

Each pad can be assigned any MIDI control change CC#00–CC#119, or a desired MIDI note number.

However, you will normally use the default settings that are assigned when you execute the page menu command “Reset Controller MIDI Assign” with CC Default. For more information, see “Reset Controller MIDI Assign” on page 812.

The operations described below are for these CC Default settings.

**PAD1 trigger velocity (CC#110) [Bn, 6E, vv]**

**PAD2 trigger velocity (CC#111) [Bn, 6F, vv]**

**PAD3 trigger velocity (CC#112) [Bn, 70, vv]**

**PAD4 trigger velocity (CC#113) [Bn, 71, vv]**

**PAD5 trigger velocity (CC#114) [Bn, 72, vv]**

**PAD6 trigger velocity (CC#115) [Bn, 73, vv]**

**PAD7 trigger velocity (CC#116) [Bn, 74, vv]**

**PAD8 trigger velocity (CC#117) [Bn, 75, vv]**

(n: channel, vv: pad velocity)

These correspond to pads 1–8. When you play one of the KRONOS’ pads, the PAD 1–8 trigger velocity will be transmitted. The same result will occur when these messages are received.

### Silencing all notes on a specific channel

**All note off (CC#123) [Bn, 7B, 00] (value 00)**

When this is received, all currently-sounding notes on that channel will be turned off (as though the keys had been released). However, the release portion of the notes will remain.

**All sound off (CC#120) [Bn, 78, 00] (value 00)**

When this is received, all currently-sounding notes on that channel will be silenced. While the All Note Off message allows the release portion of the notes to remain, the All Sound Off message will silence the notes immediately.

However, these messages are provided for emergency use, and are not something that you will use while performing.

### Resetting all controllers on a specific channel

**Reset all controllers (CC#121) [Bn, 79, 00] (value 00)**

When this is received, the value of all controllers on that channel will be reset.

## Using RPN (Registered Parameter Numbers)

RPN (Registered Parameter Numbers) are a type of message that allow settings to be made in a way that is common between instrument manufacturers. (NRPN (Non-registered Parameter Numbers) and exclusive messages can be freely used in non-compatible ways by different manufacturers and models of instrument.)

RPN messages can be used for editing with the following procedure.

1. Use RPN MSB (CC#101) [Bn, 65, mm] and RPN LSB (CC#100) [Bn, 64, rr] (n: channel, mm, rr: upper and lower bytes of the parameter number) messages to select the parameter.
2. Use data entry MSB (CC#6) [Bn, 06, mm] and data entry LSB (CC#38) [Bn, 26, vv] (n: channel, mm, vv: upper and lower bytes of the value, together expressing 16,384 levels) to specify the value.
3. You can use data increment (CC#96) [Bn, 60, 00] or data decrement (CC#97) [Bn, 61, 00] (n: channel, value is fixed at 00) to change the value in steps of one.

The KRONOS can receive the following three RPN messages, described in detail below: tuning, transpose, and pitch bend range.

### Tuning

**RPN fine tune [Bn, 65, 00, 64, 01]**

This RPN message adjusts the detuning for Programs, Combination Timbres, and Sequencer Tracks.

The procedure is as follows.

1. [Bn, 65, 00, 64, 01]: Select RPN parameter 01.
2. [Bn, 06, mm, 26, vv]: Use data entry to set the value. A value of 8192 [mm, vv=40, 00] is center, 0 [mm, vv=00, 00] is -100 cents, and 16383 [mm, vv=7E, 7F] is +99 cents.

*Note:* You can use the universal exclusive Fine Tune message to adjust the overall tuning, corresponding to the Global **Master Tune** parameter. For more information, see “About system exclusive messages” on page 1137.

### Transposing

**RPN coarse tune [Bn, 65, 00, 64, 02]**

This RPN message adjusts the transposition for Programs, Combination Timbres, and Sequencer Tracks.

The procedure is as follows.

1. [Bn, 65, 00, 64, 02]: Select RPN parameter 02.
2. [Bn, 06, mm, 26, vv]: Use data entry to set the value. Normally only the upper byte is used.

A value of 8192 [mm, vv=40, 00] is center, 6656 [mm, vv=34, 00] is -12 semitones, and 9728 [mm, vv=4C, 00] is +12 semitones.

*Note:* You can use the universal exclusive Coarse Tune message to adjust the overall tuning, corresponding to the Global **Transpose** parameter. For more information, see “About system exclusive messages” on page 1137.

### Changing the pitch bend range

**RPN pitch bend range [Bn, 64, 00, 65, 00]**

This RPN message adjusts the pitch bend range for Programs, Combination Timbres, and Sequencer Tracks.

The procedure is as follows.

1. [Bn, 65, 00, 64, 00]: Select RPN parameter 00.
2. [Bn, 06, mm, 26, vv]: Use data entry to set the value. Normally only the upper byte is used.



A value of 0 [mm, vv=00, 00] is +00, and a value of 1536 [mm, vv=0C, 00] is +12 (one octave). Although it is possible to set a negative value for a timbre/track, only positive values can be set using RPN messages.

## About system exclusive messages

Since the way in which these messages are used is left up to each manufacturer, they are mainly used to transmit and receive sound data and editing data for parameters that are unique to a particular instrument. The KRONOS's system exclusive message format is [F0, 42, 3n, 68, ff, .... F7]

**F0:** exclusive status

**42:** Korg ID

**3n:** [n=0–F] global MIDI channel 1–16

**68:** KRONOS model ID

**ff:** function ID (type of message)

:

:

**F7:** end of exclusive

*Note:* To obtain a copy of the "MIDI Implementation" which includes MIDI System Exclusive format information, please contact your Korg distributor.

## Universal system exclusive

Certain of the system exclusive messages are publicly defined for a specific use, and these are called universal system exclusive messages.

The KRONOS uses the following six universal system exclusive messages.

**Inquiry message request [F0, 7E, nn, 06, 01, F7]**

**Inquiry message [F0, 7E, nn, 06, 02, (nine bytes), F7]**

When an inquiry message request is received, the KRONOS will respond by transmitting an inquiry message that means "I am a Korg KRONOS, with system version ..."

**GM system on [F0, 7E, nn, 09, 01, F7]**

When this message is received in Sequencer mode, the KRONOS will be initialized for GM playback.

**Master volume [F0, 7E, nn, 04, 01, vv, mm, F7]**

(vv: lower byte of the value, mm: upper byte of the value, together indicating 16384 steps)

This message is transmitted if you assign Master Volume as the function of the ASSIGNABLE PEDAL or as a REALTIME KNOBS 5–8 and operate the controller. This will adjust the overall volume balance without changing the relative volume balance between timbres/tracks. When this message is received, the result will be the same as when the controller is operated.

**Master balance [F0, 7E, nn, 04, 02, vv, mm, F7]**

(vv: lower byte of the value, mm: upper byte of the value, together indicating 16384 steps, where 8192 is the default position, and lower values will move the sound toward the left)

When this is received, the overall panning will be adjusted without changing the relative panning between timbres/tracks.

**Master fine tuning [F0, 7E, nn, 04, 03, vv, mm, F7]**

(A value of 8192 [mm, vv=40, 00] is center, 4096 [mm, vv=20, 00] is –50 cents, and 12288 [mm, vv=60, 00] is +50 cents.)

When this is received, the "Master Tune" (Global P0: 0–1a) parameter will be set.

**Master coarse tuning [F0, 7E, nn, 04, 04, vv, mm, F7]**

(Normally only the upper byte mm is used. A value of 8192 [mm, vv=40, 00] is center, 6656 [mm, vv=34, 00] is –12 semitones, and 9728 [mm, vv=4C, 00] is +12 semitones.)

When this is received, the **Key Transpose** (Global 0–1a) parameter will be set.

## Transmitting sound settings data (Data Dump)

Data for programs, combinations, drum kits, wave sequences, global settings, and sequencer data can be transmitted as MIDI System Exclusive messages. The operation of sending this system exclusive data to an external device is called a "data dump."

By performing a data dump, you can store the KRONOS's sounds and settings on an external device, or rewrite the sounds and settings of another KRONOS.

There are the following two types of data dump.

- When you use the "Dump" (Global P1) page menu command to dump data, various types of internal memory data will be transmitted. If this data is received by the KRONOS, the data will be written directly into internal memory, and it will not be necessary to perform the Write operation.
- If the "Enable Exclusive" (Global 1–1c) setting is checked, data will also be dumped in response to a Dump Request message. This data is transmitted and received on the global MIDI channel.

When the KRONOS receives this data, the data will be written into the edit buffer. If you want to save the data into internal memory, you'll have to execute the Write operation. This can be done either by executing the Write operation on the KRONOS itself, or by a MIDI System Exclusive program write request, combination write request, drum kit write request, wave sequence write request, or global setting write request.

### Cautions regarding data dumps and sound editing

- After MIDI System Exclusive data has been received and processed, a Data Load Completed message will be transmitted. The control master device must not transmit the next message until this message is received (or until a sufficient interval of time has elapsed).
- When you change use parameter changes to edit, the changes will affect the data in the edit buffer and will not be stored in internal memory unless you Write, so that the changes will be lost if you re-select the program or combination. The Write operation can be performed by a MIDI System Exclusive Program Write Request or Combination Write Request message, in addition to the usual method of using the KRONOS's switches. For more

information, see “Loading & saving data, and creating CDs” on page 181 of the Operation Guide.

- It is not necessary to write a song, but it will not be backed up when the power is turned off. If you want to keep the song data, you must save it to the internal hard disk or other media before powering off. “Saving to disks, CDs, and USB media” on page 186 of the Operation Guide.

---

### Editing sounds via SysEx

By using various MIDI System Exclusive data dumps, you can rewrite all programs or an individual program. By using parameter change messages, you can edit individual parameters as follows.

Parameter changes

- In Program mode, all parameters other than the program name can be edited.
- In Combination mode, parameters other than the combination name can be edited.
- In Sequencer mode, you can edit the track parameters in P0, 1, and 2, and the P7: KARMA, P8: Insert Effect, and P9: Master/Total Effect parameters.

Drum kit parameter change/Wave sequence parameter change

In Global mode, you can edit drum kits and wave sequences.

Since the other global parameters or Sequencer mode musical data cannot be edited, you will use data dumps to transfer this data.

Data dumping of Sampling mode data is not supported.

The global MIDI channel is used to transmit and receive this data.

First check the “Enable Exclusive” (Global 1–1c) setting to enable transmission and reception of exclusive data. When you switch modes on the KRONOS, a mode change will be transmitted. When you edit individual parameters, parameter change messages will be transmitted.

When these messages are received, the same editing operation will be performed as on the transmitted device.

---

### If notes are “stuck”

If for some reason, notes become “stuck” and will not stop sounding, you can silence them by doing the following:

1. **Select a different sound, including any Program, Combination, Song, or Set List Slot.**
2. **Select a different sound again.**

For instance, within a Set List with Slot 1 selected, select Slot 2 and then return to Slot 1. Or, on Program A000, press the front-panel **COMBI** button (which selects a Combination) and then press the front-panel **PROG** button (to re-select the previous Program). At the second change, all notes held from the original sound will be stolen.

If notes played via MIDI are stuck, you can also disconnect the MIDI cable.

MIDI transmits a message called Active Sensing [FE] at regular intervals. A device that receives this message will be aware that an external MIDI device is transmitting to it. Subsequently, if no MIDI messages are received for a certain interval of time, the receiving device will decide that the connection has been broken, and will turn off any notes that had been sounded via MIDI and reset its controller values.

---

### Playing the KRONOS multi-timbrally from an external device

The KRONOS can be connected to an external device and played multi-timbrally in the following ways.

- MIDI messages from the external device can play a combination (16-part multi-timbral performance). You can change the overall settings (programs, levels, and effects) by using program change messages to switch combinations.
- MIDI messages from the external device can be used to play a song (16-part multi-timbral performance). Overall settings (programs, levels, effects etc.) can be changed by using a Song Select message to switch songs. (Song Select messages can be received if **MIDI Clock: Global 1–1a** is set to External MIDI.)
- MIDI Clock messages from the external device can be used to make the KRONOS playback a song (set **MIDI Clock** to External MIDI, and run the KRONOS’s sequencer). (“Synchronizing the playback of KARMA or sequencer”) You can change the overall settings (programs, levels, effects) by using song select messages to switch songs.

---

### Synchronizing the playback of KARMA or sequencer

The choice of whether the KRONOS will be the master (the controlling device) or the slave (the controlled device) is made by **MIDI Clock** (Global 1–1a).

*Note:* When MIDI Clock is set to Auto, the KRONOS will normally operate in the same way as for the Internal setting. When an external MIDI clock is received from the MIDI IN connector, the KRONOS will automatically operate as for the External MIDI setting.

### Using the KRONOS as master and the external MIDI device as slave

Connect the KRONOS’s MIDI OUT connector to the MIDI IN connector of the external MIDI device.

- When you set **MIDI Clock** to Internal, the KRONOS will be the master device, and will transmit MIDI timing clock messages.

**KARMA function:** The tempo can be controlled from the KRONOS. At the same time, the performance generated by KARMA will be transmitted via MIDI. (In Combination, and Sequencer modes, data will be transmitted by timbres/MIDI tracks whose **Status** is BTH, EXT, or



EX2.) An external tone generator connected to MIDI OUT will sound, and the tempo of an external sequencer can be controlled.

**Sequencer:** The musical data can be played back and controlled on the KRONOS.

Simultaneously, the sequencer playback will be transmitted via MIDI from MIDI tracks whose **Status** is BTH, EXT, or EX2. An external tone generator connected to MIDI OUT will sound, and the tempo of an external sequencer can be controlled.

### Using the external MIDI device as master and the KRONOS as slave

Connect the KRONOS's MIDI IN connector to the MIDI OUT connector of the external MIDI device.

- When you set **MIDI Clock** to External MIDI, the KRONOS will be the slave device.

**KARMA:** The tempo will follow the MIDI clock. If you play the external sequencer, the KARMA will synchronize to the external clock.

Even if **MIDI Clock** is External MIDI and the KRONOS is being controlled from the external device, the performance of KARMA will still be transmitted via MIDI. (In Combination and Sequencer modes, KARMA will be transmitted from timbres/MIDI tracks whose **Status** is BTH, EXT, or EX2.)

**Sequencer:** It will not be possible to control the playback from the KRONOS; instead, playback will be controlled by the external device. If you wish to play the external sequencer in sync with the KRONOS's sequencer, you must first set the same time signature and starting measure locations on both devices.

Even if **MIDI Clock** is set to External MIDI and the KRONOS is being controlled from an external device, musical data will be transmitted by tracks whose **Status** is BTH, EXT, or EX2.

---

### Recording MIDI from an external sequencer

You can record the MIDI output of an external sequencer into the KRONOS using either synchronized or un-synchronized MIDI clocks. Each method has its benefits and caveats, as described below.

In either case, you will need to set up the KRONOS sequencer for multitrack recording. For more information, see "Multi (multitrack recording)" on page 80 of the Operation Guide.

#### Synchronized clocks

Generally, the best method is to synchronize the KRONOS to the external sequencer. To do this:

1. **Set the Global MIDI Clock to External MIDI.**

This lets the external sequencer control both the tempo and the point at which recording starts.

2. **Set the KRONOS time signature to match that of the external sequencer.**

3. **Start recording on the KRONOS.**

4. **Start the external sequencer.**

With **MIDI Clock** set to External MIDI, the KRONOS will start recording automatically as soon as the external sequencer starts playback.

Since the two devices are synchronized during the recording process, measure divisions etc. will be preserved accurately. Synchronization is also critical if you need to record in multiple passes, as opposed to all tracks at once.

The one drawback of this method is that any changes to tempo or time signature will not be recorded. If any of these are used, you will have to re-create them within the KRONOS sequencer after recording.

#### Un-synchronized clocks

If you need to record tempo changes in real-time, instead of re-creating them later, you can also record without synchronizing the clocks. To do this:

1. **Set the Global MIDI Clock to Internal.**
2. **Start recording on the KRONOS.**
3. **Start the external sequencer.**

This records incoming MIDI data exactly as it is received, preserving any tempo changes.

The drawback of this method is that data regarding measure divisions and rhythmic values will not be preserved. So, this method is not suitable if you intend to edit the data later.

---

### Recording the MIDI output of the KRONOS's controllers, KARMA, and internal sequencer to an external sequencer or computer

If you wish to record the MIDI output of the KRONOS's controllers, KARMA function, and internal sequencer on an external sequencer or computer and use the KRONOS as the monitoring and playback tone generator while you record, you must turn off the KRONOS's Local Control setting ("Local Control On" Global 1-1a), and set your external sequencer/computer for echo-back (a function by which the data received at MIDI IN is retransmitted without change from MIDI OUT) so that the data from the KRONOS's controllers, KARMA function and internal sequencer will not be applied in duplicate to the tone generator.

---

### Using the REALTIME KNOBS 1-8 to record MIDI control changes on an external MIDI sequencer/computer

Set the KRONOS to Local Control Off. Set the external MIDI sequencer/computer to Echo Back On. With these settings, recording and playback will occur correctly, and the control changes will not be applied to the tone generator in duplicate.

## Recording KARMA or RPPR function on an external MIDI sequencer/computer

When KARMA is on, playing the keyboard or operating the controllers of the KRONOS will operate and control KARMA.

In the same way, KARMA will be controlled by MIDI messages received from MIDI IN (if “Enable MIDI In to KARMA Module” in Global 1–1b is turned on).

Notes transmitted from MIDI OUT by KARMA are controlled as follows, according to the local control setting (“Local Control On” Global 1–1a) and the “Enable KARMA Module to MIDI Out” (Global 1–1b) setting.

In Sequencer mode, when the RPPR function is on, playing the keyboard will cause RPPR to operate. Similarly, the RPPR function will also operate in response to notes received on the MIDI channel of the track selected by **Track Select** (Sequencer 0–1a). Notes will be transmitted by RPPR from MIDI OUT according to the local control setting (“Local Control On”) as described below.

**Local Control On:** Notes from KARMA or RPPR will be transmitted from MIDI OUT. However, MIDI transmission from the KARMA module is valid only if “Enable KARMA Module to MIDI Out” is on. Normally you will use this setting.

**Local Control Off:** Notes from KARMA or RPPR will not be transmitted from MIDI OUT. The KRONOS will sound only in response to MIDI messages received at MIDI IN, or generated by KARMA or RPPR.

### Setting example 1

To record the note messages generated by KARMA or RPPR on the external MIDI sequencer/computer:

1. Turn on KARMA or RPPR.
2. On Global P1:MIDI, enable Local Control On.
3. Make the following KARMA External Routing settings (Global 1–1b).

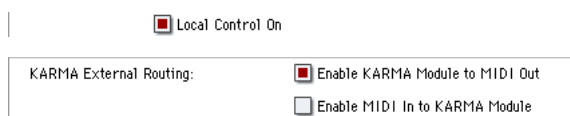

4. On your external sequencer or computer, turn the echo back setting Off.

When you’re recording a performance generated by KARMA or RPPR, this setting will prevent duplicate notes from being sounded by the echo-back. (Turn the RPPR function off for playback.)

### Setting example 2

To use the external MIDI sequencer/computer to record only the notes that trigger KARMA or RPPR, and operate KARMA or RPPR for monitoring while recording, and during playback:

1. Turn on KARMA or RPPR.
2. On Global P1:MIDI, disable Local Control On.
3. Make the following KARMA External Routing settings (Global 1–1b).

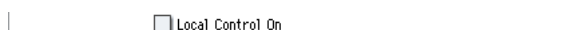

Notes generated by KARMA or RPPR will not be output.

4. On your external MIDI sequencer or computer, turn on the echo back setting.

This allows recording to occur correctly, without KARMA or the RPPR function being applied in duplicate.

## About GM (General MIDI)

The KRONOS supports the GM standard. It also supports the GM2 sound map (including bank select) with 256 programs and 9 drum programs provided in ROM banks G, g(1)–g(9), and g(d). (Banks g(1)–g(9) are GM2 variation programs, and g(d) contains drum programs.)

GM is a standard that ensures basic compatibility of sounds and controllers between GM-compatible instruments made by different manufacturers. When using GM with KRONOS, be aware of the following.

- GM System On is supported in Sequencer mode. For more information, see “GM Initialize” on page 626.
- When you wish to play a GM sequence, or load GM data into a song, set “Bank Map” (Global 0–1d) to GM(2).

## About standard MIDI files

Standard MIDI files (SMF) make it possible for different computer programs or musical instruments made by different manufacturers to exchange time-based MIDI data. Each standard MIDI file contains one song. The KRONOS supports format 0 (type 0) in which all of the MIDI data is combined into one track, and format 1 (type 1) in which the data is separated by track.

When a SMF is loaded into a song in Disk mode, the program bank that is selected will differ depending on the “Bank Map” (Global 0–1d) setting. When playing/loading SMF data that conforms to the GM specifications, set “Bank Map” to GM(2).

### Sequencer mode

In Disk mode when you convert a song into a Standard MIDI File and save it, you can choose either format 0 or format 1.

- If KRONOS song data that was saved as a format 1 SMF file is loaded into another device, the track configuration may be different than it was before being saved. This is because MIDI tracks that contain no musical data are omitted, and the remaining tracks are moved into the unused tracks. This will not affect the playback itself.
- If song data that was saved by another device as a format 1 SMF file is loaded into the KRONOS, the track configuration may be different than it was before being saved. This is because tracks that contain no musical data are omitted, and the

remaining tracks are moved into the unused tracks.  
This will not affect the playback itself.

When exchanging sequence data between two KRONOS, we recommend that you save the sequence data in the KRONOS's native format ("Save SEQ").

When sequence data is saved in the KRONOS's native format, all of the settings and patterns unique to the KRONOS will be saved, which will ensure a higher level of reproducibility than when the data is saved as a Standard MIDI File ("Save to Std MIDI File").

Parameter changes and other recorded data is included in the song data as System Exclusive events, so it can be saved to or loaded from disk as usual. Exclusive messages can also be loaded or saved as SMF (Standard MIDI File) data ("Load Standard MIDI File," "Save Song as Standard MIDI File"). This allows recorded System Exclusive events to be saved as SMF data, or exclusive messages included in SMF data to be converted into song data.

During playback, this data can be transmitted to an external MIDI device, or used to control track parameters or effect parameters of the song.

# MIDI Implementation

Status [Hex]	Second [H]	Third [D]	Description	ENVA
Bn	72 (114)	(vv)	(Pads, ASW)	*3
Bn	73 (115)	(vv)	(Pads, ASW)	*3
Bn	74 (116)	(vv)	(Pads, ASW)	*3
Bn	75 (117)	(vv)	(Pads, ASW)	*3
Bn	76 (118)	(vv)	(Vector Joystick X)	*3
Bn	77 (119)	(vv)	(Vector Joystick Y)	*3
Bn	cc (cc)	(vv)	(Sequencer data)	Q
Bn	cc (cc)	(vv)	Control (cc)=0-119 (Knob = MIDI CC#00-119)	C
Bn	cc (cc)	(vv)	Control (cc)=0-119 (Vector CC = MIDI CC#00-119)	C
Bn	cc (cc)	(vv)	Control (cc)=0-119 (KARMA RTC = MIDI CC#00-119)	C
Bn	cc (cc)	(vv)	Control (cc)=0-119 (Pads = MIDI CC#00-119)	C
Bn	cc (cc)	(vv)	Control (cc)=0-119 (External Mode = MIDI CC#00-119)	C
Bn	cc (cc)	(vv)	Control (cc)=0-119 (KARMA SE data = MIDI CC#00-119)	C
Cn	pp (pp)	--	Program Change (Prog/Combi/Set List change)	*4
Cn	vv (vv)	--	Channel Pressure (After Touch)	*2
En	bb (bb)	(bb)	Bender Change (Joy Stick X)	C

PAL : Assignable Pedal  
 ASW : Assignable Switch  
 Knob : Realtime Knob5, 6, 7, 8  
 VJS : Vector Joystick CC Control  
  
 S Chg : Transmitted when change a Song No. (Seq. mode). (Status = EXT, EX2, BTH)  
 C/S Chg : Transmitted when change a Combination or Song No. (Seq. mode). (Status = EXT, EX2 or BTH)  
  
 n : MIDI Channel No. (0 - 15) ..... Usually Global Channel.  
 g : Always Global Channel No. (0 - 15)  
 ENVA = A : Always Enabled.  
 C : Enabled when Enable Control Change in Global mode is checked.  
 PA : Enabled when Enable Program Change in Global mode is checked.  
 T : Enabled when Enable After Touch in Global mode is checked.  
 Q : Enabled when Sequencer is playing (transmit), recording (receive)

\*1 : kk = 24 - 108 : KRONOS 61keys (61keys + Transpose)  
 = 16 - 112 : KRONOS 73keys (73keys + Transpose)  
 = 09 - 120 : KRONOS 88keys (88keys + Transpose)  
 = 00 - 127 : Sequencer and KARMA Module  
  
 \*2 : Program Combination MIDI Out [Hex] (Bank Map is GM(2))  
 Bank INT-A 000 - 127 : Bank INT-A 000 - 127 : mm,bb,pp = 00,00, 00 - 7F = 3F,00, 00 - 7F  
 INT-B 000 - 127 : INT-B 000 - 127 : 00,01, 00 - 7F = 3F,01, 00 - 7F  
 INT-C 000 - 127 : INT-C 000 - 127 : 00,02, 00 - 7F = 3F,02, 00 - 7F  
 INT-D 000 - 127 : INT-D 000 - 127 : 00,03, 00 - 7F = 3F,03, 00 - 7F  
 INT-E 000 - 127 : INT-E 000 - 127 : 00,04, 00 - 7F = 3F,04, 00 - 7F  
 INT-F 000 - 127 : INT-F 000 - 127 : 00,05, 00 - 7F = 3F,05, 00 - 7F  
 INT-G 000 - 127 : INT-G 000 - 127 : 00,06, 00 - 7F = 3F,06, 00 - 7F  
  
 GM 001 - 128 : 79,00, 00 - 7F = 79,00, 00 - 7F  
 g (l) - (9) 001 - 128 : 79,01-09, 00 - 7F = 79,01-09, 00 - 7F  
 g (d) 001 - 128 : 78,00, 00 - 7F = 78,00, 00 - 7F  
  
 USER-A 000 - 127 : USER-A 000 - 127 : 00,08, 00 - 7F = 3F,08, 00 - 7F  
 USER-B 000 - 127 : USER-B 000 - 127 : 00,09, 00 - 7F = 3F,09, 00 - 7F  
 USER-C 000 - 127 : USER-C 000 - 127 : 00,0A, 00 - 7F = 3F,0A, 00 - 7F  
 USER-D 000 - 127 : USER-D 000 - 127 : 00,0B, 00 - 7F = 3F,0B, 00 - 7F  
 USER-E 000 - 127 : USER-E 000 - 127 : 00,0C, 00 - 7F = 3F,0C, 00 - 7F  
 USER-F 000 - 127 : USER-F 000 - 127 : 00,0D, 00 - 7F = 3F,0D, 00 - 7F  
 USER-G 000 - 127 : USER-G 000 - 127 : 00,0E, 00 - 7F = 3F,0E, 00 - 7F  
  
 USER-BA 000 - 127 : 00,0F, 00 - 7F = 3F,0F, 00 - 7F  
 USER-BB 000 - 127 : 00,10, 00 - 7F = 3F,10, 00 - 7F  
 USER-BC 000 - 127 : 00,11, 00 - 7F = 3F,11, 00 - 7F  
 USER-BD 000 - 127 : 00,12, 00 - 7F = 3F,12, 00 - 7F  
 USER-BE 000 - 127 : 00,13, 00 - 7F = 3F,13, 00 - 7F  
 USER-BF 000 - 127 : 00,14, 00 - 7F = 3F,14, 00 - 7F  
 USER-BS 000 - 127 : 00,15, 00 - 7F = 3F,15, 00 - 7F  
  
 : Set List  
 000-127 000 - 127 (Slot) : mm,bb,pp = 00,00-7F, 00 - 7F = 00,00-7F, 00 - 7F

## KRONOS/KRONOS X MIDI IMPLEMENTATION

Consult your local Korg dealer for more information on MIDI System Exclusive Implementation.

### 1. TRANSMITTED DATA

#### 1-1 CHANNEL MESSAGES

Status [Hex]	Second [H]	Third [D]	Description	ENVA
8n	kk (kk)	vv (vv)	Note Off (vv)=1-64 (Key Off)	*1 *5 A
9n	kk (kk)	vv (vv)	Note On (vv)=1-127 (Seq On)	*1 A
An	kk (kk)	vv (vv)	Poly Key Pressure (Sequencer data)	T, Q
Bn	00 (00)	mm (mm)	(BANK keys, Prog/Combi/Set List change) *2	PB
Bn	01 (01)	vv (vv)	Modulation1 (Joystick +y, VJS/ASW/Pd1)	C
Bn	02 (02)	vv (vv)	Modulation2 (Joystick -y, VJS/ASW/Pd1)	C
Bn	04 (04)	vv (vv)	Foot Pedal (Pd1 = Foot Pedal)	C
Bn	05 (05)	vv (vv)	Portamento Time (Knob/VJS/Pd1 = Porta.Time, S Chg)	C
Bn	07 (07)	vv (vv)	Volume (Knob/VJS/Pd1 = Volume, S/C Chg)	C
Bn	08 (08)	vv (vv)	Post IFX Panpot (Knob/VJS/Pd1 = IFX Pan, S Chg)	C
Bn	0A (0A)	vv (vv)	Panpot (Knob/VJS/Pd1 = Pan, S Chg)	C
Bn	0B (0B)	vv (vv)	Expression (Knob/VJS/Pd1 = Expression)	C
Bn	0C (0C)	vv (vv)	Effect Control 1 (Knob/VJS/Pd1 = FX Control1)	C
Bn	0D (0D)	vv (vv)	Effect Control 2 (Knob/VJS/Pd1 = FX Control2)	C
Bn	0E (0E)	vv (vv)	(KARMA ON/OFF, ASW)	C
Bn	10 (10)	vv (vv)	Multi Purpose Ctrl11 (Ribbon Controller, VJS/ASW/Pd1)	C
Bn	11 (11)	vv (vv)	Multi Purpose Ctrl12 (Knob = Knob Mod5, VJS)	C
Bn	12 (12)	vv (vv)	Multi Purpose Ctrl13 (Value Slider, VJS/ASW/Pd1)	C
Bn	13 (13)	vv (vv)	Multi Purpose Ctrl14 (Knob = Knob Mod6, VJS)	C
Bn	14 (14)	vv (vv)	(Knob = Knob Mod7, VJS)	C
Bn	15 (15)	vv (vv)	(Knob = Knob Mod8, VJS)	C
Bn	16 (16)	vv (vv)	(KARMA Slider1, ASW/Pd1)	*3
Bn	17 (17)	vv (vv)	(KARMA Slider2, ASW/Pd1)	*3
Bn	18 (18)	vv (vv)	(KARMA Slider3, ASW/Pd1)	*3
Bn	19 (19)	vv (vv)	(KARMA Slider4, ASW/Pd1)	*3
Bn	1A (1A)	vv (vv)	(KARMA Slider5, ASW/Pd1)	*3
Bn	1B (1B)	vv (vv)	(KARMA Slider6, ASW/Pd1)	*3
Bn	1C (1C)	vv (vv)	(KARMA Slider7, ASW/Pd1)	*3
Bn	1D (1D)	vv (vv)	(KARMA Slider8, ASW/Pd1)	*3
Bn	1E (1E)	vv (vv)	(KARMA SCENE, ASW)	*3
Bn	1F (1F)	vv (vv)	(KARMA LATCH, ASW)	*3
Bn	20 (20)	bb (bb)	Bank Select (LSB)	*2 PB
Bn	40 (64)	vv (vv)	Hold	C
Bn	41 (65)	00/7F (00/127)	Portamento Off/On (SW1/SW2/ASW = Porta.SW, S Chg)	C
Bn	42 (66)	00/7F (00/127)	Sostenuto Off/On (ASW = Sostenuto)	C
Bn	43 (67)	vv (vv)	Soft Pedal (ASW = Soft)	C
Bn	46 (70)	vv (vv)	Sound Controller 1 (Knob/VJS = F/A Sustain)	C
Bn	47 (71)	vv (vv)	Sound Controller 2 (Knob2, Knob/VJS = Resonance, ASW/Pd1)	C
Bn	48 (72)	vv (vv)	Sound Controller 3 (Knob4, Knob/VJS = F/A Release, ASW/Pd1)	C
Bn	49 (73)	vv (vv)	Sound Controller 4 (Knob/VJS = F/A Attack)	C
Bn	4A (74)	vv (vv)	Sound Controller 5 (Knob1, Knob/VJS = Filter Cutoff, ASW/Pd1)	C
Bn	4B (75)	vv (vv)	Sound Controller 6 (Knob/VJS = F/A Decay)	C
Bn	4C (76)	vv (vv)	Sound Controller 7 (Knob/VJS = Pitch LFO1 Spd)	C
Bn	4D (77)	vv (vv)	Sound Controller 8 (Knob/VJS = Pitch LFO1 Dep)	C
Bn	4E (78)	vv (vv)	Sound Controller 9 (Knob/VJS = Pitch LFO1 Dly)	C
Bn	4F (79)	vv (vv)	Sound Controller 10 (Knob3, Knob/VJS = Filter BG Int, ASW/Pd1)	C
Bn	50 (80)	00/7F (00/127)	Multi Purpose Ctrl15 (SW1/Knob/VJS = SW1 Mod.)	C
Bn	51 (81)	00/7F (00/127)	Multi Purpose Ctrl16 (SW2/Knob/VJS = SW2 Mod.)	C
Bn	52 (82)	00/7F (00/127)	Multi Purpose Ctrl17 (ASW/Knob/VJS = Foot SW)	C
Bn	53 (83)	vv (vv)	Multi Purpose Ctrl18 (Knob/VJS = MIDI CCR#3)	C
Bn	55 (85)	vv (vv)	(VJS = VJS +X Mod.)	C
Bn	56 (86)	vv (vv)	(VJS = VJS +Y Mod.)	C
Bn	57 (87)	vv (vv)	(VJS = VJS +Z Mod.)	C
Bn	58 (88)	vv (vv)	(VJS = VJS +X Mod.)	C
Bn	5B (91)	vv (vv)	(Knob/VJS/Pd1 = MFX Send2, S Chg)	C
Bn	5C (92)	00/7F (00/127)	(All Inset/FX Off/On)	C
Bn	5D (93)	00/7F (00/127)	Effect 1 Depth (Knob/VJS/Pd1 = MFX Send1, S Chg)	C
Bn	5E (94)	00/7F (00/127)	Effect 2 Depth (Master-FX1/2 Off/On)	C
Bn	5F (95)	00/7F (00/127)	Effect 3 Depth (KARMA SW2, ASW)	*3
Bn	67 (103)	vv (vv)	(KARMA SW2, ASW)	*3
Bn	68 (104)	vv (vv)	(KARMA SW3, ASW)	*3
Bn	69 (105)	vv (vv)	(KARMA SW4, ASW)	*3
Bn	6A (106)	vv (vv)	(KARMA SW5, ASW)	*3
Bn	6B (107)	vv (vv)	(KARMA SW6, ASW)	*3
Bn	6C (108)	vv (vv)	(KARMA SW7, ASW)	*3
Bn	6D (109)	vv (vv)	(KARMA SW8, ASW)	*3
Bn	6E (110)	vv (vv)	(KARMA SW9, ASW)	*3
Bn	6F (111)	vv (vv)	(Pad2, ASW)	*3
Bn	70 (112)	vv (vv)	(Pad3, ASW)	*3
Bn	71 (113)	vv (vv)	(Padd1, ASW)	*3

1-4 SYSTEM EXCLUSIVE

1-4-1 UNIVERSAL SYSTEM EXCLUSIVE MESSAGE ( NON REALTIME )

DEVICE INQUIRY REPLY ( Transmits when received a INQUIRY MESSAGE REQUEST )  
 6th byte g : Global Channel  
 7th byte 4z : KRONOS series ID  
 8th byte mm : KRONOS 71keys member code mm = 05  
 9th byte mm : KRONOS 88keys member code mm = 05  
 10th byte vv : System Version 1st ( 0 - )  
 11th byte ww : System Version 2nd ( 0 - )  
 12th byte xx : System Version 3rd ( 0 - )  
 (i.e., Version 1.0.2: vv=01, ww=00, xx=02 )

1-4-2 UNIVERSAL SYSTEM EXCLUSIVE MESSAGES ( REALTIME )

Master Volume  
 [ F0,7F,09,04,01,vv,mm,F7 ]  
 3rd byte g : Global Channel  
 6th byte vv : Value(LSB)  
 7th byte mm : Value(MSB)  
 mm,vv = 00,00 - 7F,7F : Min - Max

\*3 : When CC# by "CC Default" is assigned to the KARMA Controllers, Vector Joystick X, Y and Pads in Global Mode.

Reset Controller MIDI Assign = CC Default

KARMA ON/OFF :CC#14  
 KARMA Slider1 :CC#22  
 KARMA Slider2 :CC#23  
 KARMA Slider3 :CC#24  
 KARMA Slider4 :CC#25  
 KARMA Slider5 :CC#26  
 KARMA Slider6 :CC#27  
 KARMA Slider7 :CC#28  
 KARMA SCENE :CC#30  
 KARMA SCENE :CC#30  
 KARMA LATCH :CC#31  
 KARMA SW1 :CC#102  
 KARMA SW2 :CC#103  
 KARMA SW3 :CC#104  
 KARMA SW4 :CC#105  
 KARMA SW5 :CC#106  
 KARMA SW6 :CC#107  
 KARMA SW7 :CC#108  
 KARMA SW8 :CC#109  
 Pad1 :CC#110  
 Pad2 :CC#111  
 Pad3 :CC#112  
 Pad4 :CC#113  
 Pad5 :CC#114  
 Pad6 :CC#115  
 Pad7 :CC#116  
 Pad8 :CC#117  
 Vector Joystick X :CC#118  
 Vector Joystick Y :CC#119

\*4 : Transmitted when turn KARMA On.  
 Transmitted when change a GE. (KARMA ON/OFF = On)  
 Transmitted when change a Program, Combination or Song No. (Seq. mode) (KARMA ON/OFF = On)

\*5 : (vv) = 64 is always transmitted at Sequencer playback.

1-2 SYSTEM COMMON MESSAGES

[H] : Hex, [D] : Decimal

Status (Hex)	Second (H) [D]	Third (H) [D]	Description ( Transmitted when )
F2	ss (ss)	tt (tt)	Song Position Pointer ss : Least significant (LSB) tt : Most significant (MSB) *6
F3	ss (ss)		Song Select (Song is selected) ss : Song (0-127) *6

Transmits Song Position Pointer message when in Sequencer mode. (Internal Clock)  
 Transmits Song Select message when in Sequencer mode. (Internal Clock)

\*6 : For example, if time signature is 4/4 or 8/8, tt,ss = 00,10 means one measure.

1-3 SYSTEM REALTIME MESSAGES

Status(Hex)	Description ( Transmitted when ... )
F8	Timing Clock ( Always in Prog/Combi/Seq mode ) *7
FA	Start ( START in Seq mode ) *7
FB	Continue ( Trigger KARMA in Prog/Combi mode ) *7, *8
FC	Stop ( Continue START in Seq mode ) *7
FE	Active Sensing ( STOP in Seq mode ) *7
	( Always ) ( Trigger KARMA in Prog/Combi mode ) *7, *8

\*7 Transmits these messages when MIDI Clock in Global mode is Internal.  
 \*8 Transmits these messages when Enable Start/Stop out in Prog/Combi in Global mode is Enabled.

2. RECOGNIZED RECEIVE DATA  
2-1 CHANNEL MESSAGES

Status [Hex]	Second [H] [D]	Third [H] [D]	Description ( Use ..... )	ENVA
Bn	6A (106)	3F/40 (63/64)	Note Off (vv) = 0-127	A
Bn	6B (107)	3F/40 (63/64)	Note On (vv) = 1-127	A
Bn	6C (108)	3F/40 (63/64)	Poly Key Pressure (as AMS)	A
Bn	6D (109)	3F/40 (63/64)	Bank Select (MSB) (for Prog/Combi/Set List change)	*1
Bn	6E (110)	vv (vv)	Modulation1 (as Joy Stick +Y)	C
Bn	6F (111)	vv (vv)	Modulation2 (as Joy Stick -Y)	C
Bn	70 (112)	vv (vv)	Foot Pedal (as AMS & FX Dmod Src = Foot Pedal)	C
Bn	71 (113)	vv (vv)	Portamento Time	C
Bn	72 (114)	vv (vv)	Data Entry (MSB) (for RFC edit)	C
Bn	73 (115)	vv (vv)	Volume Control (for Post IFX Panpot control)	*2
Bn	74 (116)	vv (vv)	Panpot	C
Bn	75 (117)	vv (vv)	Expression	C
Bn	76 (118)	vv (vv)	Effect Control 1 (as FX Dmod Src = Fx Control1)	C
Bn	77 (119)	vv (vv)	Effect Control 2 (as FX Dmod Src = Fx Control2)	C
Bn	78 (120)	00 (00)	Effect Control 2 (as KARMA ON/OFF)	*4
Bn	79 (121)	00 (00)	Multi Purpose Ctrl1 (as Ribbon Controller)	C
Bn	7A (122)	00/7F (00/127)	Multi Purpose Ctrl1 (as AMS & FX Dmod Src = Knob Mod5)	C
Bn	7B (123)	00 (00)	Multi Purpose Ctrl2 (as Value Slider)	C
Bn	7C (124)	00 (00)	Multi Purpose Ctrl2 (as AMS & FX Dmod Src = Knob Mod6)	C
Bn	7D (125)	00 (00)	Multi Purpose Ctrl3 (as AMS & FX Dmod Src = Knob Mod7)	C
Bn	7E (126)	10 (16)	Multi Purpose Ctrl4 (as AMS & FX Dmod Src = Knob Mod8)	C
Bn	7F (127)	00 (00)	(as AMS & FX Dmod Src = Knob Mod8)	C
Ch	pp (pp)	-- --	(as KARMA Sliders1)	*4
Dh	vv (vv)	-- --	(as KARMA Sliders2)	*4
En	bb (bb)	bb (bb)	(as KARMA Sliders3)	*4
			(as KARMA Sliders4)	*4
			(as KARMA Sliders5)	*4
			(as KARMA Sliders6)	*4
			(as KARMA Sliders7)	*4
			(as KARMA Sliders8)	*4
			(as KARMA SCENEL...8 Control)	*4
			(as KARMA LATCH)	*4
			(for Prog/Combi/Set List change)	*1
			(for RFC edit)	C
			(as Damper)	C
			(for Sustain Level control)	C
			(for Resonance control)	C
			(for Release Time control)	C
			(for Attack Time control)	C
			(for Filter Cutoff control)	C
			(for Decay Time control)	C
			(for LF01 Speed control)	C
			(for LF01 Pitch Depth control)	C
			(for LF01 Delay control)	C
			(for Filter EG Intensity control)	C
			(as AMS & FX Dmod Src = SW 1)	C
			(as AMS & FX Dmod Src = SW 2)	C
			(as AMS & FX Dmod Src = Foot Switch)	C
			(as AMS & FX Dmod Src = CTR83)	C
			(as AMS & FX Dmod Src = Vector Mod X)	C
			(as AMS & FX Dmod Src = Vector Mod Y)	C
			(as AMS & FX Dmod Src = Vector Mod -Y)	C
			(for Send 2 Level control)	C
			(for All Insert FX Off/On)	C
			(for Send 1 Level control)	C
			(for Master FX1,2 Off/On)	C
			(for Total FX1,2 Off/On)	C
			(for RPC edit)	C
			(for RPN select)	*3
			RPN Param No. (LSB) (for RPN select)	*3
			(as KARMA SW1)	*4
			(as KARMA SW2)	*4
			(as KARMA SW3)	*4
			(as KARMA SW4)	*4

AMS : Alternate Modulation Sources  
 FX Dmod Src : Effect Dynamic Modulation Source  
 n : MIDI Channel No. (0 - 15) \*\*\*\*\* Usually Global Channel.  
 When in Combination/Sequencer mode, each Limbre S/Track's channel. (Status is INT or BTH)  
 When KARMA Module Input in Combination/Sequencer mode, Input Channel of each KARMA Module  
 g : All Keys Global Channel No. (0 - 15)  
 x : Bank  
 ENVA : Same as Transmitted data

\*1 : When Bank Map in Global mode is KORG;

MIDI In [Hex]	Program mm,bb,pp	Combination
00,00	00 - 7F	Bank INT-A 000 - 127
00,01	00 - 7F	INT-B 000 - 127
00,02	00 - 7F	INT-C 000 - 127
00,03	00 - 7F	INT-D 000 - 127
00,04	00 - 7F	INT-E 000 - 127
00,05	00 - 7F	INT-F 000 - 127
00,06	00 - 7F	INT-G 000 - 127
00,08	00 - 7F	USER-A 000 - 127
00,09	00 - 7F	USER-B 000 - 127
00,0A	00 - 7F	USER-C 000 - 127
00,0B	00 - 7F	USER-D 000 - 127
00,0C	00 - 7F	USER-E 000 - 127
00,0D	00 - 7F	USER-F 000 - 127
00,0E	00 - 7F	USER-G 000 - 127
00,0F	00 - 7F	USER-AA 000 - 127
00,10	00 - 7F	USER-BB 000 - 127
00,11	00 - 7F	USER-CC 000 - 127
00,12	00 - 7F	USER-DD 000 - 127
00,13	00 - 7F	USER-EE 000 - 127
00,14	00 - 7F	USER-FF 000 - 127
00,15	00 - 7F	USER-GS 000 - 127
79,00	00 - 7F	G 001 - 128
79,01-09	00 - 7F	g (L)-g (9) 001 - 128
79,0A	00 - 7F	g (d) 001 - 128
38,00	00 - 7F	G 001 - 128
3E,00	00 - 7F	g (d) 001 - 128

MIDI In [Hex] Set List  
 mm,bb,pp = 00,00-7F, 00 - 7F : 000-127 000 - 127 (slot)

2-3 SYSTEM REALTIME MESSAGES

Status[Hex]	Description ( Use for..... )
F8	Timing Clock ( Tempo, RMS & FX Dmod Src ) *6
FA	Start ( Seg Start & KARMA Control ) *7
FB	Continue ( Seg Continue start & KARMA Control ) *7
FC	Stop ( Seg Stop & KARMA Control ) *7
FE	Active Sensing ( MIDI Connect check )

\*6 Receive when MIDI Clock in Global mode is External MIDI.  
 \*6 Receive when MIDI Clock in Global mode is External MIDI.  
 and Receive EX: RealTime Commands in Global mode is checked.

2-4 SYSTEM EXCLUSIVE

2-4-1 UNIVERSAL SYSTEM EXCLUSIVE MESSAGE ( NON REALTIME )

DEVICE INQUIRY ( When received this message, transmits INQUIRY MESSAGE REPLY )  
 [ F0,7E,nn,06,01,F7 ] 3rd byte nn : Channel = 0 - F : Global Channel  
 = 7F : Any Channel

GM System On ( Receive when in Sequencer mode )  
 [ F0,7E,nn,09,01,F7 ] 3rd byte nn : Channel = 0 - F : Global Channel  
 = 7F : Any Channel

2-4-2 UNIVERSAL SYSTEM EXCLUSIVE MESSAGES ( REALTIME )

Master Volume  
 [ F0,7F,0g,04,01,vv,mm,F7 ] 3rd byte g : Global Channel  
 6th byte vv : Value (LSB)  
 7th byte mm : Value (MSB)  
 mm, vv = 00,00 : Left, 40,00 : Center, 7F,7F : Min - Max

Master Balance  
 [ F0,7F,0g,04,02,vv,mm,F7 ] 3rd byte g : Global Channel  
 6th byte vv : Value (LSB)  
 7th byte mm : Value (MSB)  
 mm, vv = 00,00 : Left, 40,00 : Center, 7F,7F : Right

Master Fine Tune ( Control Master Tune (cent) in Global )  
 [ F0,7F,0g,04,03,vv,mm,F7 ] 3rd byte g : Global Channel  
 6th byte vv : Value (LSB)  
 7th byte mm : Value (MSB)  
 mm, vv = 20,00 : -50, 40,00 : +00, 60,00 : +50

Master Coarse Tune ( Control Transpose (chromatic step) in Global )  
 [ F0,7F,0g,04,04,vv,mm,F7 ] 3rd byte g : Global Channel  
 6th byte vv : Value (LSB)  
 7th byte mm : Value (MSB)  
 mm, vv = 34,00 : -12, 40,00 : +00, 4C,00 : +12

: When Bank Map in Global mode is GM (2) :

MIDI In [Hex] : Program

mm,bb,pp =	00 - 7F	Program	Combination
3F,00	00 - 7F	Bank INT-A 000 - 127	Bank INT-A 000 - 127
3F,01	00 - 7F	INT-B 000 - 127	INT-B 000 - 127
3F,02	00 - 7F	INT-C 000 - 127	INT-C 000 - 127
3F,03	00 - 7F	INT-D 000 - 127	INT-D 000 - 127
3F,04	00 - 7F	INT-E 000 - 127	INT-E 000 - 127
3F,05	00 - 7F	INT-F 000 - 127	INT-F 000 - 127
3F,06	00 - 7F	INT-G 000 - 127	INT-G 000 - 127
3F,07	00 - 7F	USER-A 000 - 127	USER-A 000 - 127
3F,08	00 - 7F	USER-B 000 - 127	USER-B 000 - 127
3F,09	00 - 7F	USER-C 000 - 127	USER-C 000 - 127
3F,0A	00 - 7F	USER-D 000 - 127	USER-D 000 - 127
3F,0B	00 - 7F	USER-E 000 - 127	USER-E 000 - 127
3F,0C	00 - 7F	USER-F 000 - 127	USER-F 000 - 127
3F,0D	00 - 7F	USER-G 000 - 127	USER-G 000 - 127
3F,0E	00 - 7F	USER-AA 000 - 127	USER-AA 000 - 127
3F,0F	00 - 7F	USER-BB 000 - 127	USER-BB 000 - 127
3F,10	00 - 7F	USER-CC 000 - 127	USER-CC 000 - 127
3F,11	00 - 7F	USER-DD 000 - 127	USER-DD 000 - 127
3F,12	00 - 7F	USER-EE 000 - 127	USER-EE 000 - 127
3F,13	00 - 7F	USER-FF 000 - 127	USER-FF 000 - 127
3F,14	00 - 7F	USER-GG 000 - 127	USER-GG 000 - 127
3F,15	00 - 7F	USER-GG 000 - 127	USER-GG 000 - 127
79,00	00 - 7F	g 001 - 128	
79,01-09	00 - 7F	g(1)-g(9) 001 - 128	
78,00	00 - 7F	g(d) 001 - 128	
00,00	00 - 7F	g 001 - 128	
38,00	00 - 7F	g 001 - 128	
3E,00	00 - 7F	g(d) 001 - 128	

MIDI In [Hex] : Set List

mm,bb,pp = 00,00-7F, 00 - 7F : 000-127 000 - 127(Slot)

\*2 : When in Program/Sampling mode, Global channel.

When in Combination/Sequencer mode, each IFX's channel.

\*3 : r = 0 : Pitch Bend Sensitivity ( Bend Range )  
 = 1 : Fine Tune ( Detune )  
 = 2 : Coarse Tune ( Transpose )

For drum program, both of Fine Tune and Coarse Tune affect to Detune.  
 Data Entry LSB value has no effect for Pitch Bend Sensitivity and Coarse Tune.

\*4 : When CC# by "CC Default" is assigned to the KARMA Controllers, Vector Joystick X, Y and Pads in Global Mode.

n : When in Program/Combination mode, Global channel.

When in Sequencer mode, current selected track's channel.

\*5 : Note Off Velocity values (vv) = 0 - 127 are not recorded in Sequencer.

2-2 SYSTEM COMMON MESSAGES

Status [Hex]	Second [H]	Third [D]	Fourth [P]	Description ( Use for..... )
F2	ss (ss)	tt (tt)		Song Position Pointer ( Location ) *7 ss : Least significant [LSB] tt : Most significant [MSB]
F3	ss (ss)			Song Select (Song select) *6 ss : Song (0-127) No.

Receive when in Sequencer mode.



## Disk mode and file format information

---

### AIFF and WAVE format details: importing

---

#### AIFF files

When data is loaded into the KRONOS, the following four chunks are referenced: Common chunk, Sound Data chunk, Marker chunk, and Instrument chunk. Other chunks are ignored.

Restrictions on the parameters in each chunk are described below.

#### Common chunk

Only one (mono) or two (stereo) channels are supported. Sample sizes of 1–24 bits are supported.

If the sample data is 8 bits or less, it will be loaded as 16 bit data with the lower 8 bits always at 0.

#### Sound Data chunk

Offset and block size are ignored. (Block-Aligning Sound Data is not supported.)

#### Marker chunk

Up to eight markers are supported. The ninth and subsequent markers will be ignored.

#### Instrument chunk

If the loop play mode is ForwardBackwardLooping, this will be handled as ForwardLooping. baseNote, detune, lowNote, highNote, lowVelocity, highVelocity, gain, and releaseLoop will be ignored.

#### WAVE files

When loading, the KRONOS references the Format Chunk, Sample Chunk, and Wave Data. Limitations are discussed below.

#### Format chunk

Standard PCM format is the only format category that is supported.

Only one (mono) or two (stereo) channels are supported.

Sample sizes of 1–24 bits are supported. If the sample data is 8 bits or less, it will be loaded as 16 bit data with the lower 8 bits always at 0.

#### Sample Chunk

Only the loop data is referenced. If there is multiple loop data, the loop with the greatest number of loop playback times (Play Count) will be used. Even if the Type is Alternating or Backward, it will be handled as Forward Loop.

#### Wave data

The Wave List chunk is not supported.

### AIFF and WAVE format details: exporting

---

#### AIFF files

When exporting, the KRONOS will use the Common Chunk, Sound Data Chunk, Marker Chunk, and Instrument Chunk.

Limitations on the parameters within each chunk are discussed below.

#### Common Chunk

The number of channels is fixed at 1 (mono).

The sample size is fixed at 16 bits.

#### Marker Chunk

Two markers are used as Loop Start Address and End Address respectively.

#### Instrument Chunk

The loop play mode is fixed at Forward Looping.

Zone data of the multisamples will not be exported.

#### Format Chunk

The format category is fixed at standard PCM format.

The number of channels is 1 (mono) or 2 (stereo), and is fixed at 1 (mono) for export.

16- and 24-bit sample sizes are supported.

#### Sample Chunk

The Type is fixed at Forward Loop.

Zone data of the multisamples will not be exported.

#### WAVE files

When exporting, the KRONOS will use the Format Chunk, Sample Chunk, and Wave Data. Restrictions are given below.

## Korg format sample files

### Korg format file structure

There are three types of sample-related Korg-format files: .KMP files for multisamples, .KSF files for samples, and .KSC files which handle the first two as a collection. Similar to the AIFF format, .KMP/.KSF files consist of chunks.

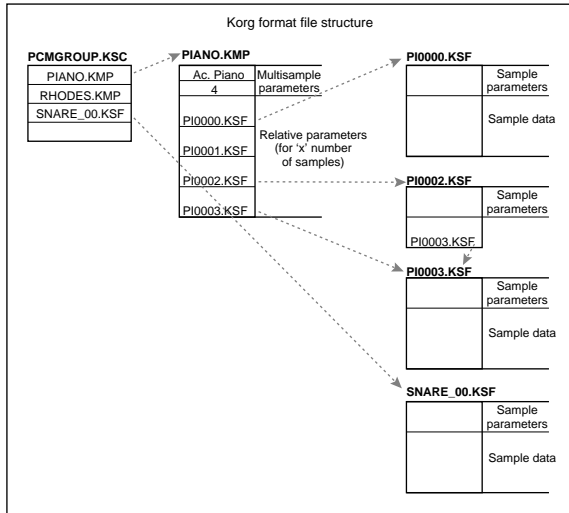

Unless stated otherwise, all data is Big Endian.

### TRINITY Compatibility

#### Loading KRONOS multisamples into the TRINITY

When loading KRONOS multisamples into the TRINITY, the following parameters are ignored:

- RLP1 chunk: **Filter cutoff**
- RLP2 chunk: **Transpose, Resonance, Attack, and Decay**
- RLP3 chunk: **Drive, Boost, LowEQLevel, MidEQLevel, and HighEQLevel**

#### Loading KRONOS samples into the TRINITY

- The **Reverse Playback** and **Loop Off** settings (included in the attribute parameters of the SMD1 chunk) will be ignored, and will be handled respectively as forward playback and loop on.
- The **+12dB** setting is ignored.
- Split sample files cannot be loaded.
- The KRONOS supports a broader range of sampling frequencies than the TRINITY. If the sampling frequency is not supported by the TRINITY, the next-lowest frequency will be selected.

#### Loading TRINITY files into the KRONOS

When a Korg format file saved on the TRINITY is loaded into the KRONOS:

- Compressed sample files cannot be loaded.
- Multisamples that use internal samples of the Trinity will be assigned to identically-numbered samples in Sampling Mode.

### TRITON Compatibility

#### Loading KRONOS multisamples into the TRITON

When loading a KRONOS .KMP file into the TRITON, the following parameters are ignored: **Drive, Boost, LowEQLevel, MidEQLevel, and HighEQLevel**. All of these parameters are in the RLP3 chunk.

#### Loading KRONOS samples into the TRITON

- The **+12dB** setting is supported by the TRITON STUDIO and TRITON EXTREME, but not by the TRITON, TRITON-Rack, or TRITON Le.
- The KRONOS supports a broader range of sampling frequencies than the TRITON. If the sampling frequency is not supported by the TRITON, the next-lowest frequency will be selected.

### KMP (Korg Multisample Parameter) files

These consist of the following chunks.

- Multisample parameter chunk

Chunk ID ('MSP1')	[4 bytes]
Chunk size (fixed at 18)	[4 bytes]
Multisample name	[16 bytes]
Number of samples in the multisample	[1 byte]
Attributes	[1 byte]

- Attributes

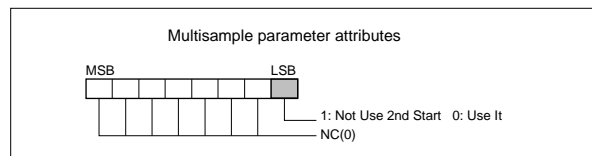

- Multisample name chunk

Chunk ID ('NAME')	[4 bytes]
Chunk size (fixed at 24)	[4 bytes]
Multisample name	[24 bytes]

- Relative parameter chunk 1

Chunk ID ('RLP1')	[4 bytes]
Chunk size (18 × number of samples in the multisample)	[4 bytes]
Original key	[1 byte]
MSB 1: Non Transpose 0: Transpose	
bits 6-0 original key	
Top key (0-127)	[1 byte]
Tune (-99...+99 cents)	[1 byte]
Level (-99...+99 cents)	[1 byte]
Pan (0-127 currently unused)	[1 byte]

Filter cutoff (-99...+99 currently unused)	[1 byte]
KSF filename (including period and extension)	[12 bytes]

If the .KSF filename is "SKIPPEDSAMPL", it will be treated as a sample skipped during loading.

Legacy files may include .KSF filenames of "INTERNALnnnn", which designated internal samples on previous Korg instruments. On the KRONOS, this feature is not supported.

- Relative parameter chunk 2

Chunk ID ('RLP2')	[4 bytes]
Chunk size (4)	[4 bytes]
Transposing (-64...+63)	[1 byte]
Resonance (-99...+99)	[1 byte]
Attack (-99...+99)	[1 byte]
Decay (-99...+99)	[1 byte]

- Relative parameter chunk 3

Chunk ID ('RLP3')	[4 bytes]
Chunk size (fixed at 6)	[4 bytes]
Drive (-99...+99)	[1 byte]
Boost (-99...+99)	[1 byte]
LowEQLevel (-99...+99)	[1 byte]
MidEQLevel (-99...+99)	[1 byte]
HighEQLevel (-99...+99)	[1 byte]
unused	[1 byte]

- Multisample number chunk

Chunk ID('MNO1')	[4 bytes]
Chunk size (4)	[4 bytes]
Multisample number (0-)	[4 bytes]

### KSF (Korg Sample File) files

There are four types of structure for these files. One consists of a Sample Parameter chunk, Sample Data chunk, Sample Number chunk and Sample name (SMP1 + SMD1 + SNO1 + NAME). Another consists of a Sample Parameter chunk, Sample Data chunk, Sample Filename chunk, Sample Number chunk, and Sample name chunk (SMP1 + SMD1 + SMF1 + SNO1 + NAME). The latter structure is in the case where the sample data of the Sample chunk is empty, and uses the sample data of the .KSF file specified by the Sample Filename chunk (shared sample data).

When saving to a floppy disk and a single disk cannot accommodate all of the data, it is possible to automatically divide the file and continue the save operation.

When a .KSF file is created in this way, the first file will consist of the Sample Parameter chunk, Sample Number chunk, and Sample name a divided Sample Parameter chunk, and a divided Sample Data chunk (SMP1 + SNO1 + NAME + SPD1 + SDD1), and the second and subsequent files will consist of a divided Sample Data chunk (SDD1).

- Sample parameter chunk

Chunk ID ('SMP1')	[4 bytes]
Chunk size (32)	[4 bytes]
Sample name	[16 bytes]
Start address	[4 bytes]
2nd start address	[4 bytes]
Loop start address	[4 bytes]
Loop end address	[4 bytes]

- Sample data chunk

Chunk ID ('SMD1')	[4 bytes]
Chunk size (12 + number of sample databytes)	[4 bytes]
Sampling frequency	[4 bytes]
Attributes	[1 byte]
Loop tune (-99...+99 cents)	[1 byte]
Number of channels (1)	[1 byte]
Sample size (8/16)	[1 byte]
Number of samples	[4 bytes]

Sample data	variable length
-------------	-----------------

- Attributes

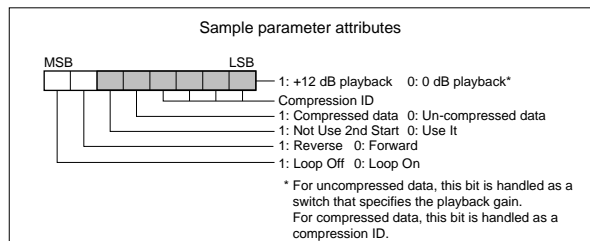

- Sample number chunk

Chunk ID ('SNO1')	[4 bytes]
Chunk size (4)	[4 bytes]
Sample number (0-)	[4 bytes]

- Sample name chunk

Chunk ID ('NAME')	[4 bytes]
Chunk size (fixed at 24)	[4 bytes]
Sample name	[24 bytes]

- Sample filename chunk

Chunk ID ('SMF1')	[4 bytes]
Chunk size (12)	[4 bytes]
KSF filename	[12 bytes]

If the .KSF filename is "SKIPPEDSAMPL", it will be treated as a sample skipped during loading.

If the .KSF filename is "INTERNALnnnn", internal samples will be used.

- Divided sample parameter chunk

Chunk ID ('SPD1')	[4 bytes]
Chunk size (12)	[4 bytes]
The following up to the sample size is the same as in the SMD1 chunk	
Sampling frequency	[4 bytes]
Attributes	[1 byte]
Loop tune	[1 byte]
Number of channels	[1 byte]
Sample size	[1 byte]
Number of samples	[4 bytes]
Total number of samples in all divided files	

- Divided sample data chunk

Chunk ID ('SDD1')	[4 bytes]
Chunk size (4 + number of sample databytes)	[4 bytes]
Random ID	[2 bytes]
File Number	[2 bytes]
PCM data bytes	

### KSC (Korg Sample Collection) files

KSC files group together any set of Sampling Mode Samples and Multisamples (.KMP and .KSF files) and/or any set of links to EXs or User Sample Bank Multisamples and Drum Samples. This lets you load all of the sample data with a single command, or automatically load the data at startup.

When you save a KSC which includes Sampling Mode data, two KSC files are created:

- A KSC with the name you've specified, which includes the actual Samples and Multisamples from Sampling Mode.
- A second KSC which includes links to the first KSC's Sampling Mode Data, with Load Method set to Virtual Memory. The name for this KSC is the name you've specified followed by the text UserBank. For instance, if the first KSC is named BillGig.KSC, the second will be BillGig\_UserBank.KSC. This is the file that you'll load to access the sample data as a User Sample Bank.

Both files may contain references to other EXs or User Sample Banks, depending on the setting of the Include parameter in the Save dialog.

KSC files have been used in previous Korg products, including the TRITON and OASYS. These products used the KSC 1.0 format, while the KRONOS uses a the new, expanded KSC 2.0 format. A further set of extensions are added in Kronos 2.0 to support User Sample Banks. These extensions will be ignored by versions prior to Kronos 2.0.

For compatibility purposes, the KSC 2.0 format begins with the same first line as the KSC 1.0 format:

```
#Korg Script Version 1.0
```

A version 2 file is indicated if the second line is:

```
#v2
```

In Kronos 2.0+, KSCs which contain Sampling Mode data include a UUID (universally unique identifier):

```
#uuid:2b4b0aa0-4d31-11e1-b86c-0800200c9a66
```

This uuid line will be ignored on versions prior to Kronos 2.0. Files which contain only links to EXs and/or User Sample Banks will not include a UUID.

Programs, Wave Sequences, Drum Kits, and other KSCs link to the Sampling Mode data as a User Sample Bank via this UUID.

Following the UUID (if present) is the list of any Sampling Mode data Samples or Multisamples (KMP/KSF filenames). This part of the data is comparable with KSC 1.0 devices. For more information, see See "KSC 1.0 format" on page 1152. This information is repeated in the 2.0 data.

After the list of .KMP and .KSF files, the 2.0 data is embedded in comments, as follows:

#### 1. #>User.A.B.FILENAME

"#>User" indicates a reference to a user Sample/Multisample.

A and B are reserved for future use.

FILENAME is the name of the KMP/KSF.

#### 2. #>EXSN.TTI.V.B.NAME

"#>EXS" indicates a reference to an EXs Multisample/Drum Sample.

N is the EXs bank number, counting from 0. Note that this is offset by one from the user-viewable numbers, so for instance EXS0 = EXs1 ROM Expansion.

Important: the maximum EXs# representable in this syntax is 125. EXs banks > 125 will be referred to by UUID as in #3 below.

TT indicates whether the entry is a Multisample or Drum Sample (MS = Multisample, DS = Drum Sample).

V indicates whether playback is from Virtual Memory or RAM (0 = RAM, 1 = Virtual Memory).

B is reserved for future use.

NAME is the Multisample/Drum Sample name.

#### 3. #>>uuid:U.TTI.V.B.NAME

This is the more generalized of #2 above, which is a link to an EXs bank or user bank Multisample or Drumsample. It is used and recognized only by KRONOS software versions 2.0 and higher.

U is the 36-character UUID for the referenced bank. TT, V, B, and NAME are the same as in #2.

Lines of this type will be ignored in versions prior to Kronos 2.0. For this reason, references to EXs0...EXs125 are still written in the #2 style, for backwards compatibility.

#### 4. #>BankN.M.D.Name

"#>Bank" is a line containing information about an EXs bank.

N is the EXs bank number, counting from 0. Note that this is offset by one from the user-viewable numbers, so for instance EXS0 = EXs1 ROM Expansion.

Important: the maximum EXs# representable in this syntax is 125. EXs banks > 125 will be referred to by UUID as in #5 below.

M is the number of Multisamples in the bank.

D is the number of Drum Samples in the bank.

Name is the name of the bank.

### 5. #>uuid:U.M.D.NAME

This is the more generalized version in of #4 above, which is description of an EXs bank or user bank. It is used and recognized only by KRONOS software versions 2.0 and higher.

U is the 36-character UUID for the referenced bank. M, D, and NAME are the same as in #4.

Lines of this type will be ignored in versions prior to Kronos 2.0. For this reason, references to EXs0...EXs125 are still written in the #4 style, for backwards compatibility.

### Example file 1

Here's a simple pair of KSC files. Somethings.KSC contains some Sampling Mode data, and so on save the system also creates Somethings\_UserBank.KSC.

The file Somethings.KSC:

```
#KORG Script Version 1.0
#v2
#uuid:5a27d1e1-63c7-4d32-92fa-f6bc95ee6ee6
DOODL000.KMP
DOODL001.KMP
SOMET006.KMP
SOMET007.KMP
SWEEP010.KMP
SWEEP011.KMP
POLY0002.KSF
POLY0003.KSF
BASS0006.KSF
BASS0007.KSF
#>User.0.2.DOODL000.KMP
#>User.0.2.DOODL001.KMP
#>User.0.2.SOMET006.KMP
#>User.0.2.SOMET007.KMP
#>User.0.2.SWEEP010.KMP
#>User.0.2.SWEEP011.KMP
#>User.0.2.POLY0002.KSF
#>User.0.2.POLY0003.KSF
#>User.0.2.BASS0006.KSF
#>User.0.2.BASS0007.KSF
```

And the associated file Somethings\_UserBank.KSC.

```
#KORG Script Version 1.0
#v2
#>>uuid:5a27d1e1-63c7-4d32-92fa-f6bc95ee6ee6.MS0.1.0.DOODLE -L
#>>uuid:5a27d1e1-63c7-4d32-92fa-f6bc95ee6ee6.MS1.1.0.DOODLE -R
#>>uuid:5a27d1e1-63c7-4d32-92fa-f6bc95ee6ee6.MS6.1.0.SOMETHING -L
#>>uuid:5a27d1e1-63c7-4d32-92fa-f6bc95ee6ee6.MS7.1.0.SOMETHING -R
#>>uuid:5a27d1e1-63c7-4d32-92fa-f6bc95ee6ee6.MS10.1.0.SWEEPS -L
#>>uuid:5a27d1e1-63c7-4d32-92fa-f6bc95ee6ee6.MS11.1.0.SWEEPS -R
#>>uuid:5a27d1e1-63c7-4d32-92fa-f6bc95ee6ee6.DS0.1.0.Noodles -L
#>>uuid:5a27d1e1-63c7-4d32-92fa-f6bc95ee6ee6.DS1.1.0.Noodles -R
#>>uuid:5a27d1e1-63c7-4d32-92fa-f6bc95ee6ee6.DS2.1.0.poly6 -L
#>>uuid:5a27d1e1-63c7-4d32-92fa-f6bc95ee6ee6.DS3.1.0.poly6 -R
#>>uuid:5a27d1e1-63c7-4d32-92fa-f6bc95ee6ee6.DS4.1.0.SWEEPS -L
#>>uuid:5a27d1e1-63c7-4d32-92fa-f6bc95ee6ee6.DS5.1.0.SWEEPS -R
```

```
#>>uuid:5a27d1e1-63c7-4d32-92fa-f6bc95ee6ee6.DS6.1.0.bass riff -L
#>>uuid:5a27d1e1-63c7-4d32-92fa-f6bc95ee6ee6.DS7.1.0.bass riff -R
#>>uuid:5a27d1e1-63c7-4d32-92fa-f6bc95ee6ee6.DS8.1.0.BASS2 -L
#>>uuid:5a27d1e1-63c7-4d32-92fa-f6bc95ee6ee6.DS9.1.0.BASS2 -R
#>>uuid:5a27d1e1-63c7-4d32-92fa-f6bc95ee6ee6.DS10.1.0.Strum -L
#>>uuid:5a27d1e1-63c7-4d32-92fa-f6bc95ee6ee6.DS11.1.0.Strum -R
#>uuid:5a27d1e1-63c7-4d32-92fa-f6bc95ee6ee6.12.12.Somethings
```

### Example file 2

Here's a more complicated example. MyCollection.KSC and the associated MyCollection\_UserBank.KSC contain both Sampling Mode data and references to other data, including references to MS/DS from EXs1 and references to samples in a User Sample Banks called OtherThings.

The file MyCollection.KSC:

```
#Korg Script Version 1.0
#v2
#uuid:c8ea3f90-6f2a-11e1-b0c4-0800200c9a66
NEWSM000.KMP
NEWSM001.KMP
NEWSM002.KMP
TICK0000.KSF
TOCK0001.KSF
TOCK0002.KSF
#>User.0.0.NEWSM000.KMP
#>User.0.0.NEWSM001.KMP
#>User.0.0.NEWSM002.KMP
#>User.0.0.TICK0000.KSF
#>User.0.0.TOCK0001.KSF
#>User.0.0.TOCK0002.KSF
#>EXS0.MS0.1.0.Acoustic Piano 1 mp -L
#>EXS0.MS1.0.0.Acoustic Piano 1 mp -R
#>EXS0.MS2.0.0.Acoustic Piano 1 mp-mono
#>EXS0.MS3.0.0.Acoustic Piano 2 mf -L
#>EXS0.MS4.0.0.Acoustic Piano 2 mf -R
#>Bank0.229.1483.ROM Expansion
#>>uuid:fe6ee590-68b7-11e1-b86c-0800200c9a66.MS0.1.0.ACID -L
#>>uuid:fe6ee590-68b7-11e1-b86c-0800200c9a66.MS1.1.0.ACID -R
#>>uuid:fe6ee590-68b7-11e1-b86c-0800200c9a66.MS2.1.0.MONKEY MONO
#>>uuid:fe6ee590-68b7-11e1-b86c-0800200c9a66.DS0.1.0.MONKEYS
#>uuid:fe6ee590-68b7-11e1-b86c-0800200c9a66.3.1.Otherthings
```

And the associated file MyCollection\_UserBank.KSC:

```
#Korg Script Version 1.0
#v2
#>>uuid:c8ea3f90-6f2a-11e1-b0c4-0800200c9a66.MS0.1.0.Flute
#>>uuid:c8ea3f90-6f2a-11e1-b0c4-0800200c9a66.MS1.1.0.Violin
#>>uuid:c8ea3f90-6f2a-11e1-b0c4-0800200c9a66.MS2.1.0.Sirens
#>>uuid:c8ea3f90-6f2a-11e1-b0c4-0800200c9a66.DS0.1.0.Tick
#>>uuid:c8ea3f90-6f2a-11e1-b0c4-0800200c9a66.DS1.1.0.Tock 1
#>>uuid:c8ea3f90-6f2a-11e1-b0c4-0800200c9a66.DS2.1.0.Tock 2
#>uuid:c8ea3f90-6f2a-11e1-b0c4-0800200c9a66 .3.3.MyCollection
#>EXS0.MS0.1.0.Acoustic Piano 1 mp -L
#>EXS0.MS1.0.0.Acoustic Piano 1 mp -R
#>EXS0.MS2.0.0.Acoustic Piano 1 mp-mono
#>EXS0.MS3.0.0.Acoustic Piano 2 mf -L
```

```
#>EXS0.MS4.0.0.Acoustic Piano 2 mf -R
#>Bank0.229.1483.ROM Expansion
#>>uuid:fe6ee590-68b7-11e1-b86c-0800200c9a66.MS0.1.0.ACID -L
#>>uuid:fe6ee590-68b7-11e1-b86c-0800200c9a66.MS1.1.0.ACID -R
#>>uuid:fe6ee590-68b7-11e1-b86c-0800200c9a66.MS2.1.0.MONKEY MONO
#>>uuid:fe6ee590-68b7-11e1-b86c-0800200c9a66.DS0.1.0.MONKEYS
#>uuid:fe6ee590-68b7-11e1-b86c-0800200c9a66.3.1.Otherthings
```

### KSC 1.0 format

Lines beginning with # are ignored as comment lines, with the notable exception of version 2.0 data.

The first line of the file must begin with “#Korg Script Version 1.0” and subsequent lines (except for comment lines) consist only of filenames. Only files with an extension of KMP/KSF are processed.

#### Filename conventions

.KMP filename for **Save All** or **Save All Multisamples**

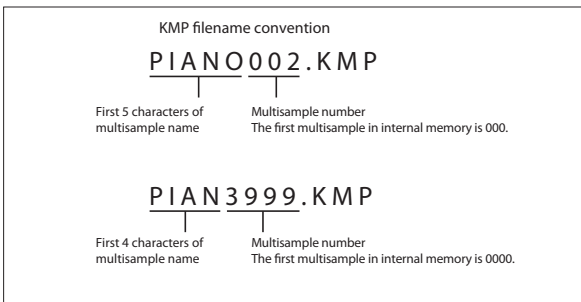

When data is saved using **Save All**, **Save All Multisample** or **Save One Multisample**, the individual .KSF files used by the Multisample (the .KMP file) are automatically given filenames according to the following convention.

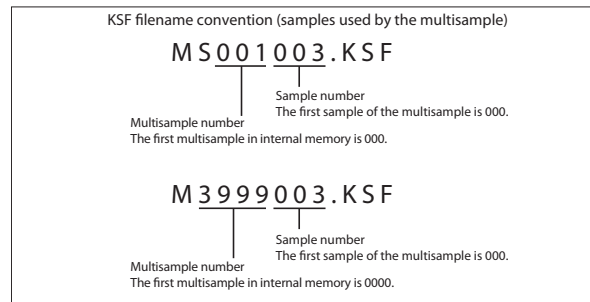

Likewise, when data is saved using **Save All** or **Save All Samples**, the individual .KSF files are automatically given filenames according to the following convention.

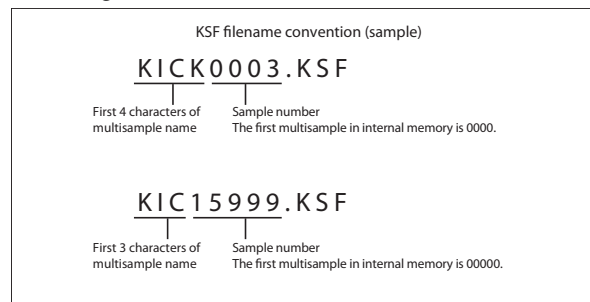

## OASYS .SNG file compatibility

The KRONOS sequencer can load and play the OASYS song format, with the following caveats.

### Preloaded sounds are different

The KRONOS’s preloaded Programs, Wave Sequences, Drum Kits, etc. are not the same as those of the OASYS. When loading a Song created on the OASYS, please also load the PCG file saved with the Song.

### Audio file directory name

Before an OASYS Song with audio files can be played, the audio directory names must be edited slightly. OASYS files were limited to 8 characters, and so the name of the audio file directory was typically abbreviated. For instance, if the .SNG file was named WAMOZART.SNG, the OASYS audio folder would be named WAMOZA\_A.

The KRONOS supports long file names, and expects to see the entire .SNG name in the audio folder name. Before you load an OASYS .SNG file, edit the name of the audio directory so that it matches the KRONOS standard: the same name as the .SNG file, followed by “\_A” (for “Audio”). In the case above, you’d rename “WAMOZA\_A” to “WAMOZART\_A.”

### Timing resolution

OASYS .SNG files have a timing resolution of 192 ppq (parts per quarter note). If these .SNG files are loaded into KRONOS or later, they will automatically be converted to 480 ppq.

In some cases, this conversion may mean that some MIDI events might not be at exactly the same timing (see illustration below). In this example, locations 1 and 3 of the 192 ppq data will be converted to locations 2 and 7 of the 480 ppq data.



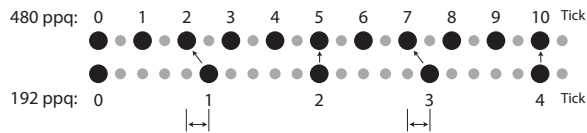

For audio tracks, the timing precision is improved by adjusting the region's Start point as well as the timing of the audio event. This is because the relative timing of audio events is more critical, due to possible problems such as phasing.

For this reason, if MIDI events and audio data that start at location 1 of the 192 ppq data in this example were converted, the MIDI data would be placed at location 2 of the 480 ppq data, while the audio data would start between locations 2 and 3 of the 480 data (corresponding to location 1 of the 192 ppq data), causing a discrepancy.

At 40.00 bpm, one tick of 480 ppq corresponds to 2.125 ms. Thus at this slowest tempo available on the KRONOS (40 bpm), the MIDI event would shift 1.5625 ms forward relative to the 192 ppq timing, and the audio would play back at virtually the same timing; an approximately 0.02 ms resolution of the sample rate.

## CD-R/RW disks on the KRONOS: UDF and packet-writing

In conjunction with an external USB CD-R/RW drive, the KRONOS lets you use CD-R/RW disks like you would a floppy disk or a removable hard disk. You can save individual files to a disk, over-write them, add new folders, and so on, without needing to "burn" an entire disk at once.

It does so by using UDF (Universal Disk Format) version 1.5 and packet writing, as described below, as its native CD-R/RW data format. Note that there are some considerations when reading these disks on computers or other equipment, as described under "Reading KRONOS CDs on other devices," below.

You can also create audio CDs, which use the standard audio CD format (CD-DA). For more information, see "1-1: Make Audio CD" on page 823, and "Creating audio CDs" on page 195 of the Operation Guide.

### About packet writing

Packet writing is a method of dividing data into small units, called "packets." This makes it possible to write individual files to CD-R/RW disks, as opposed to writing an entire disk at once.

### Compatible media

- Before writing data to a CD-R/RW disk, you must format the disk using the KRONOS.

#### CD-R media

- 650 MB and 700 MB CD-R media (up to 48x write speed)

#### CD-RW media

- 650 MB and 700 MB CD-RW media (up to 4x/10x write speeds)

### Formatting

Before using CD-R/RW disks, you need to format them. To do so, insert the blank or previously-formatted media into the drive, go to the Disk Utility page, and select the **Format** menu command.

#### Cautions when formatting

##### CD-R media

**Quick Format** takes less than a minute.

**Full Format** applies only to CD-RW media, and so it can't be selected for CD-R disks.

**Re-formatting:** Data that has been written to CD-R cannot be erased as it can on a floppy disk. This means that re-formatting previously-formatted media will not increase the free space; instead, approximately 20 MB of space will be used to add a new session.

##### CD-RW media

**Quick Format:** Use this option to erase the contents of a previously formatted CD-RW. This cannot be used with blank CD-RW media. It takes about two minutes to complete.

**Full Format:** Use this option to format blank media, or media which has been formatted as a non-UDF disk.

You can also use **Full Format** if writing errors occur frequently when writing to the disk.

**Full Format** takes about fifteen minutes for 10x CD-RW media, and about thirty minutes for 4x CD-RW media. (Depending on the condition of the disk, it may take substantially longer.)

Formatting takes up some of the space on the disk, so that 650 MB/700 MB media will have approximately 530 MB/570 MB of available space, respectively.

**Re-formatting:** Like floppy disks and hard drives, CD-RW disks can be formatted to erase any previous contents, and re-formatting frees up space on the disk.

### Deleting and updating files

#### CD-R media

With CD-R media, deleting a file merely hides it from view; the file still exists on the disk, and no space is freed by the deletion.

Similarly, when you save a new version of a file, the previous version is hidden but not actually removed from the disk. Each version of the file will take up additional space on the disk.

#### CD-RW media

CD-RW disks work the same way as hard drives. Deleting files frees up space on the disk, and saving a new version of a file (with the same name as the previous one) will overwrite the original file.

---

### Writing to CD media may take time

Writing to a CD-R/RW will generally be slower than writing to a hard disk. The time it takes to write will depend on the speed of the CD-R/RW drive, and on the writing speed supported by the media.

---

### Reading KRONOS CDs on other devices

#### CD-R media

You can read native KRONOS CDs, in UDF packet-writing format, on computers with packet-writing software installed.

For maximum compatibility, you can convert CD-Rs (not CD-RWs) into ISO9660. This makes it possible for the data to be read by other Korg devices that support the ISO9660 format, or by computers which do not have packet writing software. For more information, see "Convert to ISO9660 Format" on page 853.

*Note:* This conversion adds ISO9660 session data, which consumes approximately 20 MB of space.

#### CD-RW media

CD-RW disks cannot be converted into ISO9660 format, and so they can only be read by devices or computers which support UDF and packet-writing.

#### Korg devices which support ISO9660 format (level 1)

- KRONOS, OASYS, M3, TRITON, TRITON pro, TRITON proX, TRITON-Rack (\*1)
- D1600, D12, D16, D1200mkII, D1600mkII, D16XD, D32XD

\*1: Only the first session can be read.

#### Korg devices which support UDF version 1.5

- KRONOS, OASYS, M3, TRITON STUDIO, TRITON Extreme

#### Divided files

If data has to be read or processed while writing to a CD-R/RW, the resulting files may not be contiguous on the disk. Operations which can cause this include:

- Copying files larger than 1.9 MB from another CD-R/RW (or other media with a slow access speed)
- Using the **Rate Convert** (Disk Utility page), **Save to Std MIDI File** (Disk SAVE page), or similar commands to save directly to a CD-R/RW

If a disk in this state is converted into ISO9660 format, it will be in the divided file format supported by ISO9660 level 3.

- ⚠ Such disks cannot be read by devices that do not support ISO9660 level 3, such as the original TRITON line and some older computer operating systems. These disks can be read on newer computer operating systems, as long as you can install software which supports ISO9660 level 3 or packet writing.

---

### Troubleshooting converted CD-Rs

- ⚠ If your computer is unable to read a CD-R converted to ISO 9660 format, you may be able to read it using the following methods.

#### Disable packet writing (UDF) software

You may be unable to read the data if packet writing software is installed on your computer. If so, temporarily disable that software or uninstall it.

---

## Notice: Use of GPL and LGPL software

This product uses the Linux kernel and some GNU utilities. This software is licensed by its copyright holder according to the GNU GPL (General Public License).

The Korg KRONOS software contained in this product is dynamically linked with some software libraries subject to the LGPL (Lesser GPL) license.

Copies of the GPL and LGPL licenses, as well as the source code for the software covered under those licenses, are provided on the included Accessory Disc 2, in the folder named "src."

The complete list of software covered under the GPL, LGPL, and other free or open-source licenses which are used in the KRONOS, including the above software, is included in the same folder.

- These files are provided in accordance with the spirit of free software, and are not required in order to use this product.
- You cannot access these files directly from the KRONOS. To read them, you will need to use a separate computer running Windows, MacOS, Linux, or any other operating system capable of reading standard text files and tar, gzip, and bzip2 archives.

The Korg KRONOS software is copyright Korg Inc., and is independent of Linux. Its use is covered by the Korg KRONOS Software License, described elsewhere in the documentation. The GPL license does not apply to this software, and its source code is not provided.

Korg accepts no responsibility for any direct or consequential damages that may occur due to the use of or the inability to use any of the system software including the above software.





Linux is a trademark or registered trademark of Linus Torvalds in the United States and in other countries.

## Updating the system

### 1. Downloading the system update

The most recent system update can be downloaded to a computer from the Korg website (<http://www.korg.com/kronos>). For more details, see the instructions on the website.

### 2. Updating the system

-  Before you start the update process, back up important data on external USB storage media.
  - 1. **Using a computer, download the update from the Korg website: [www.korg.com/kronos](http://www.korg.com/kronos).**  
The update will be in compressed, zip format.
  - 2. **Un-zip the downloaded file.**  
Un-zipping will result in a main folder containing several different files and at least one sub-folder.
  - 3. **Follow any instructions included with the update.**
  - 4. **Open the folder containing the update files and sub-folders.**
  - 5. **From within this folder, copy the update files and sub-folder(s) to the root level of a FAT32-formatted USB storage device, such as a USB flash drive.**
  -  Copy the files and sub-folders only; don't copy the main, enclosing folder.
  -  FAT32 format is required. Other formats, including NTFS (Windows) or HFS+ (Mac OS X), will not work. Most USB flash drives use FAT32 by default.
  - 6. **Disconnect all USB devices from the KRONOS.**  
Other USB devices may interfere with the update process.
  - 7. **Go to the Global P0– Basic Setup page.**  
To go to this page from any part of the system, press the GLOBAL button to enter Global mode, and press the EXIT switch up to four times.
  - 8. **Open the menu, and select the command “Update System Software.”**  
A prompt will appear on the screen, instructing you to connect the USB storage device which contains the update file.
  - 9. **Connect the USB storage device containing the update file(s), from step 5 above.**
  - 10. **Press the OK button.**  
A message and progress bar will appear on the screen, noting that the system is being updated.
  -  Do not disconnect the USB storage device while the update is in progress.
  -  While the system is being updated, do not touch the KRONOS' switches, and never turn off the power. If the power is accidentally turned off while the system is being loaded, the KRONOS may become inoperable. If this occurs, using the Restore DVDs may be required; please contact your local Korg distributor.
- When the update is complete, a new message will appear:  
 “Update to KRONOS system version [nn] complete. Please turn off the power, wait a moment, and then turn on power again to use the new software.”

11. **Turn off the KRONOS, and then disconnect the USB storage device.**

12. **Wait approximately ten seconds, and then turn the power on again.**

The system version number is shown on the startup screen, and also on the Global P6–Options Info page. Verify that it is correct.

## Restoring the system and factory sounds

If for some reason the KRONOS will not start up normally, or some other problem occurs, you can use the included set of Accessory Discs to return the KRONOS to its factory-preset state.

### Important - save your data before proceeding!

All of the Restore functions will erase all of the Programs, Combis, Drum Kits, Wave Sequences, Set Lists, Global settings, and other user data in the internal memory. Some of the functions will also erase data from the FACTORY directory on the hard drive, or even erase the hard drive entirely, as detailed below.

If you have any data that you want to keep—including data stored on the hard drive as well as data in the internal memory—we strongly recommend that you save it to a CD-R/RW disk, or to external USB media, before proceeding. For instance, use the Save All or Save .PCG commands to save the contents of the internal memory.

## Contents of the Accessory Discs

### Accessory Disc 1

This disc is only for use by the restore functionality, and do not include any user-readable data.

### Accessory Disc 2

This is the only disc with user-readable data, as described below. In addition to the data used for the restore functionality, it contains the following:

- **FACTORY directory:** This contains original factory sounds, including Programs, Combinations, Wave Sequences, Drum Kits, Set Lists, Global Settings, etc. These are used by the Restore feature, but you can also load them directly in Disk mode.
- **licenses directory:** This contains the Korg KRONOS software license, in both English and Japanese, along the open-source GPL and LGPL licenses (in English).
- **src directory:** This contains the source code applicable to the GPL and LGPL licenses.
- **manuals directory:** This contains various KRONOS documentation, including the Operation Guide and Parameter Guide, the Voice Name List (VNL), and so on.
- **MIDI Implementation**
- **Catalog**
- **Mac directory:** This contains KRONOS external setups, the Korg USB MIDI driver installer, and the Software Licensing Agreement.
- **Windows directory:** This contains KRONOS external setups, the Korg USB MIDI driver installer, and the Software Licensing Agreement.

**NOTE:** Only the FACTORY directory can be used directly on the KRONOS. All of the files in the other directories can only be read from a computer.

## Restoring the KRONOS factory data

You can use the Restore function to restore the factory sounds (Programs, Combis, etc.), to initialize the internal memory, or to restore the operating system to its original state. These three options will not alter any user data stored on the disk, as long as it is not stored in the FACTORY folder.

If absolutely necessary, you can also re-format the entire internal hard disk, and then restore the operating system and factory sounds. This will destroy all user data on the internal hard disk, and may require re-authorization of the KRONOS before it can be used again—so be careful!

To use the Restore function:

1. **Disconnect all external USB devices from the KRONOS, except for a DVD drive.**

 External USB devices other than the DVD drive may interfere with the restoration process.

2. **Insert Accessory Disc 1 into a connected USB DVD drive.**

3. **Turn off the KRONOS. Wait for about ten seconds, and then power-on again.**

 Be sure to wait for about ten seconds before you turn on the power.

4. **A dialog box will appear. Use the  $\triangle$  /  $\nabla$  switches, the VALUE dial, or numeric keys 1-4 to choose one of the following options:**

1. Format and Full Install
2. Full Install
3. Install Factory Sounds
4. Initialize Memory

See below for complete descriptions of each option.

If the disk is not formatted properly for the KRONOS, then the above menu is not shown. Instead, the following message will be displayed:

“The disk is not formatted for the Kronos”

In this case, the only option offered is to perform a format and full install.

5. **Press the ENTER button to carry out the selected Restore function, or press EXIT to stop the process without altering any data.**

After pressing ENTER, an “Are you sure?” message will appear. If you are sure you want to proceed, press the ENTER switch again. You can also cancel, without altering any data, by pressing the EXIT button.

6. **After pressing ENTER, the restore program will start up. Follow the instructions that appear in the screen.**

You’ll be asked to insert different DVD discs, depending on the option you chose in step 4. When a disc is requested, insert the appropriate disc, and then press the ENTER switch. The entire process may take some time.



 Do not touch the front-panel controls or turn off the power while the Restore is underway, except for pressing ENTER and EXIT as prompted by the on-screen instructions.

## 7. When the restore operation is complete, the following message will appear:

**Installation Completed!**

**Please remove installation media and power down the system.**

If an error occurs, you'll see an error message instead. In this case, start again at step 3.

### 1. Format and Full Install

This option completely erases the internal hard drive, and then restores the operating system, the factory sounds and settings, and the demo songs, as described under "2. Full Install," below.

**IMPORTANT:** Normally, you should not need to do this—and you should **avoid using this function if at all possible**. Always try using the **Full Install** option first.

However, if for some reason the internal hard disk has been completely corrupted, and using **Full Install** does not fix the problem, this will allow you to restore the hard drive to its initial state.

**IMPORTANT:** after using this function, you may need to re-authorize the KRONOS, as described below. If this is required, you'll see a message at startup titled "Re-authorization required." Follow the instructions below to re-authorize. You will not be able to use the KRONOS until the re-authorization is complete.

### 2. Full Install

If for some reason the KRONOS will no longer start up normally, try this option first. It does the following:

- Restores the system software on the internal hard drive.
- Initializes the internal memory, and re-loads the original factory preload data—including all Programs, Combinations, Drum Kits, Wave Sequences, and Global settings.
- Erases all files inside the internal hard drive's **FACTORY** directory, and then restores the factory preload files, including the **PRELOAD.PCG** file and the demo sequences.

### 3. Install factory sounds

This option restores the factory sounds, settings, and demos in memory and on disk, as described under "2. Full Install," above.

Unlike **Full Install**, however, this option does not replace the operating system.

### 4. Initialize Memory

This option erases all of the Programs, Combinations, Drum Kits, Wave Sequences, and other data in the internal memory, leaving only blank data. The factory preload data is not restored.

Unlike the other three options, **Initialize Memory** does not affect the data stored on disk in any way.

## Re-authorizing KRONOS

KRONOS uses a Digital Rights Management system to protect its proprietary components. After formatting the internal hard drive, you may see the following message at startup:

Re-authorization required

Please write down the Public ID shown below, and then go to <http://www.korg.com/kronos/>

(If you cannot access the internet, please contact your local Korg dealer or distributor.)

Follow the website instructions to get the re-authorization file, and copy it to a USB device.

Insert USB device and press <ENTER>

Public ID: nn nn nn nn nn nn nn nn (where nn are characters 0-9 and a-f)

To re-authorize the system:

### 1. After using the "Format and Full Install" function, turn off the KRONOS.

At start-up, the LCD display will show a "Public ID." This is a unique identifier, like a very specific name; it is different for each and every KRONOS.

### 2. Write down the Public ID shown at the bottom of the screen. Make sure that you've copied it accurately.

The Public ID is 16 characters long, and uses only the characters 0-9 and a-f.

### 3. Turn off the power.

You'll need to complete the re-authorization process before using KRONOS any further.

### 4. Go to <http://www.korg.com/kronos/>, and follow the instructions to download the re-authorization file.

or:

**If you do not have internet access, please contact your Korg dealer or distributor.**

When contacting your Korg dealer or distributor, let them know that you need to re-authorize your KRONOS, and give them the Public ID that you wrote down in step 2.

You can find contact information for all Korg distributors, world-wide, on the Korg website:

<http://www.korg.co.jp/English/index.html>

Once you have the re-authorization file, either via download or from your Korg dealer or distributor:

### 5. Copy the file to the root level of a USB storage device.

Don't put it inside a folder or directory.

### 6. Turn on the KRONOS, and wait for the "Re-authorization required" screen to appear.

### 7. Connect the USB device to the KRONOS.

### 8. Press ENTER.

The system will search for the re-authorization file on the USB device. When the file is located, the last line of the screen will show the following message:

Re-authorization file found. Press <ENTER> to install.

If a valid re-authorization file is not located, the following message will be shown instead:

Re-authorization file not found. Press <ENTER> to continue.

If this message appears, make sure that the file is on the root directory of the USB device, and that its name has not been changed (it should be 14 characters long, followed by the suffix “.reauth”). Once you’ve double-checked the file name and location, try again starting at step 6.

**9. Press ENTER to start the reauthorization.**

When the re-authorization is complete, the last line of the screen will change to the following message:

Re-authorization successful! Please turn off power, wait, and turn on again.

**10. Turn off the power, wait 10 seconds, and then turn on the power again.**

Your KRONOS will now be re-authorized and ready to use.

#### **IMPORTANT NOTICE TO CONSUMERS**

This product has been manufactured according to strict specifications and voltage requirements that are applicable in the country in which it is intended that this product should be used. If you have purchased this product via the internet, through mail order, and/or via a telephone sale, you must verify that this product is intended to be used in the country in which you reside. **WARNING:** Use of this product in any country other than that for which it is intended could be dangerous and could invalidate the manufacturer's or distributor's warranty. Please also retain your receipt as proof of purchase otherwise your product may be disqualified from the manufacturer's or distributor's warranty.